



US00D983391S

(12) **United States Design Patent** (10) **Patent No.:** **US D983,391 S**
Jacobson et al. (45) **Date of Patent:** **** Apr. 11, 2023**

(54) **ERECTILE BAND**

(71) Applicant: **Giddy Holdings, Inc.**, Austin, TX (US)

(72) Inventors: **Brett Jacobson**, Austin, TX (US);
Sebastian Miller, Philadelphia, PA (US)

(73) Assignee: **Giddy Holdings, Inc.**, Austin, TX (US)

(**) Term: **15 Years**

(21) Appl. No.: **29/690,855**

(22) Filed: **May 10, 2019**

(51) **LOC (14) Cl.** **28-03**

(52) **U.S. Cl.**
USPC **D24/215**

(58) **Field of Classification Search**
USPC D24/200, 211, 212, 213, 214, 215, 195;
D30/160
CPC A61H 19/32; A61H 19/50
See application file for complete search history.

(56) **References Cited**

U.S. PATENT DOCUMENTS

1,225,341 A 5/1917 Lederer
3,511,230 A 5/1970 Strong
3,759,253 A 9/1973 Cray
3,794,020 A 2/1974 Bagby
4,203,432 A 5/1980 Koch
D343,454 S 1/1994 Osbon
5,306,227 A 4/1994 Osbon et al.
5,327,910 A 7/1994 Flynn
5,336,157 A 8/1994 Hale
6,319,194 B1 11/2001 Wulf
6,659,938 B1 12/2003 Orłowski et al.
6,907,883 B2* 6/2005 Lin A61F 5/41
128/842
D523,958 S * 6/2006 Fang D24/105
D552,748 S * 10/2007 Gromosaik D11/26
D552,749 S * 10/2007 Gromosaik D11/26
D552,750 S * 10/2007 Gromosaik D11/26
D557,805 S * 12/2007 Gromosaik D24/105
D557,806 S * 12/2007 Gromosaik D24/105
D564,666 S * 3/2008 Klearman D11/26

D581,544 S * 11/2008 Adams D24/105
D643,129 S * 8/2011 Talbot D24/215
D674,477 S * 1/2013 Beresford-Wylie D24/105
D674,910 S * 1/2013 Adams D24/215
D676,141 S * 2/2013 Wu D24/215
D684,701 S * 6/2013 Uygur D24/215
D694,897 S * 12/2013 Small D24/215
D702,363 S * 4/2014 Tai D24/215
D704,346 S * 5/2014 Tai D24/215
D704,347 S * 5/2014 Tai D24/215
D706,436 S * 6/2014 Hahr D24/215
D706,437 S * 6/2014 Hahr D24/215
D706,438 S * 6/2014 Hahr D24/215
D706,439 S * 6/2014 Hahr D24/215
D706,443 S * 6/2014 Hahr D24/215
D707,840 S * 6/2014 Levine D24/215
D707,841 S * 6/2014 Levine D24/215
D725,283 S * 3/2015 Sedic D24/215
D727,526 S * 4/2015 Mercado Diaz D24/215
D742,535 S * 11/2015 Wu D24/215
D752,298 S * 3/2016 Stephens D30/199
D771,270 S * 11/2016 Tai D24/215
D771,831 S * 11/2016 Barnard D24/215
D773,066 S * 11/2016 Sedic D24/215
9,700,454 B2 7/2017 Parlante
D793,571 S * 8/2017 Iurchenko D24/215
D808,034 S * 1/2018 Matsuura D24/215
D824,037 S * 7/2018 Yueh D24/215
10,064,750 B2 9/2018 Howard
2002/0103415 A1* 8/2002 Manska A61H 19/32
600/38
2003/0024536 A1 2/2003 Bagby
2003/0083598 A1 5/2003 Kobayashi et al.
2005/0277907 A1 12/2005 Jackson
2005/0283044 A1* 12/2005 Chang A61F 5/41
600/38
2007/0118199 A1* 5/2007 Yang A61H 19/00
607/143
2009/0012355 A1* 1/2009 Lin A61H 19/50
600/41
2009/0069629 A1* 3/2009 Uson Calvo A61H 19/34
600/38
2009/0306468 A1* 12/2009 Tasker A61H 19/50
600/41
2009/0318755 A1* 12/2009 Adams A61F 5/41
600/41
2010/0179379 A1 7/2010 Park
2012/0259254 A1* 10/2012 Chen A61H 19/40
601/46
2015/0157531 A1* 6/2015 Sedic A61H 19/32
601/46
2015/0290023 A1 10/2015 Parlante

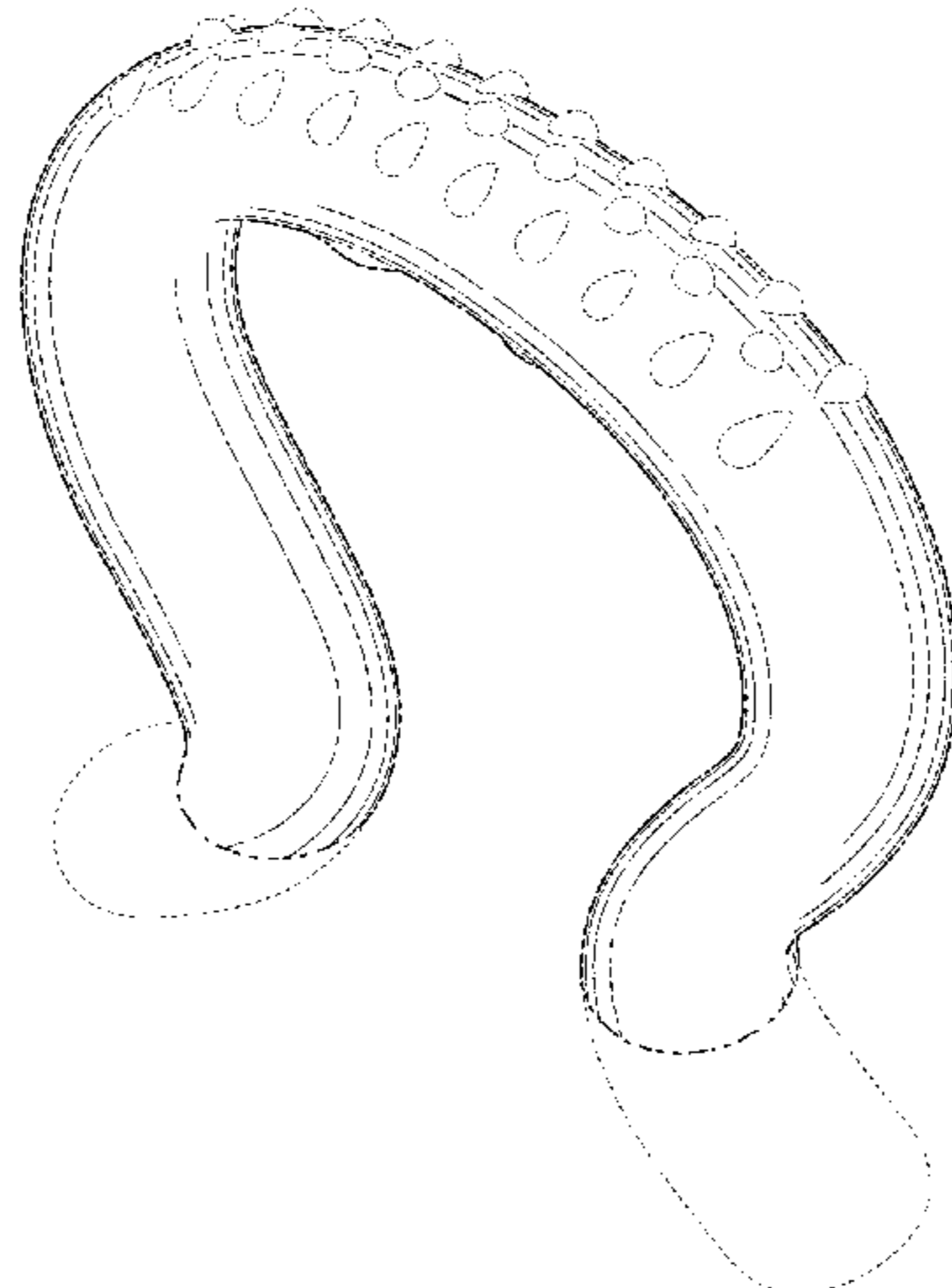

2015/0313749	A1*	11/2015	Hahr	A61H 19/50 600/39
2016/0106569	A1*	4/2016	Hahr	A61F 5/41 600/41
2017/0042757	A1*	2/2017	Wang	A61H 19/34
2018/0193221	A1*	7/2018	Li	A61H 19/32
2018/0193620	A1*	7/2018	Barasch	A61H 19/32
2020/0069511	A1*	3/2020	Lopez	G06F 3/0346
2020/0093685	A1*	3/2020	Luke	A61H 1/00
2022/0218509	A1	7/2022	Jacobson et al.		

FOREIGN PATENT DOCUMENTS

CA	2838404	A1	7/2015
WO	WO-2020231780	A1	11/2020
WO	WO-2022046911	A2	3/2022

OTHER PUBLICATIONS

Amazon, "Couple Vibrator", Nov. 20, 2019. <https://www.amazon.com/Couple-Vibrator-Penis-Clitoral-Stimulation/dp/B07YSB7S7D>. Shown on p. 1. (Year: 2019).*

PCT/US2020/032021 International Search Report and Written Opinion dated Aug. 12, 2020.

Veale et al., Am I normal? A systematic review and construction of nomograms for flaccid and erect penis length and circumference in up to 15,521 men. *BJU International* 115(6): 26 pages (2014).

International Search Report and Written Opinion dated Feb. 16, 2022 for International Application No. PCT/US2021/047556.

Feb. 1, 2023 Non-Final Office Action U.S. Appl. No. 17/610,128.

European Patent Application No. 20805793.5 Extended European Search Report dated Nov. 25, 2022.

* cited by examiner

Primary Examiner — Michael A Maharajh
(74) *Attorney, Agent, or Firm* — Wilson Sonsini Goodrich & Rosati

(57) **CLAIM**

The ornamental design for an erectile band, as shown and described.

DESCRIPTION

FIG. 1 is a top, front, right perspective view of a first erectile band, showing our new design;
 FIG. 2 is a front elevational view thereof;
 FIG. 3 is a back elevational view thereof;
 FIG. 4 is a right side elevational view thereof;
 FIG. 5 is a left side elevational view thereof;
 FIG. 6 is a top plan view thereof;
 FIG. 7 is a bottom plan view thereof;
 FIG. 8 is a top, front, right perspective view of a first alternative embodiment of the first erectile band, showing our new design;
 FIG. 9 is a front elevational view thereof;
 FIG. 10 is a back elevational view thereof;
 FIG. 11 is a right side elevational view thereof;
 FIG. 12 is a left side elevational view thereof;
 FIG. 13 is a top plan view thereof;
 FIG. 14 is a bottom plan view thereof;
 FIG. 15 is a top, front, right perspective view of a second alternative embodiment of the first erectile band, showing our new design;
 FIG. 16 is a front elevational view thereof;
 FIG. 17 is a back elevational view thereof;
 FIG. 18 is a right side elevational view thereof;
 FIG. 19 is a left side elevational view thereof;

FIG. 20 is a top plan view thereof;
 FIG. 21 is a bottom plan view thereof;
 FIG. 22 is a top, front, right perspective view of a third alternative embodiment of the first erectile band, showing our new design;
 FIG. 23 is a front elevational view thereof;
 FIG. 24 is a back elevational view thereof;
 FIG. 25 is a right side elevational view thereof;
 FIG. 26 is a left side elevational view thereof;
 FIG. 27 is a top plan view thereof;
 FIG. 28 is a bottom plan view thereof;
 FIG. 29 is a top, front, right perspective view of a second erectile band, showing our new design;
 FIG. 30 is a front elevational view thereof;
 FIG. 31 is a back elevational view thereof;
 FIG. 32 is a right side elevational view thereof;
 FIG. 33 is a left side elevational view thereof;
 FIG. 34 is a top plan view thereof;
 FIG. 35 is a bottom plan view thereof;
 FIG. 36 is a top, front, right perspective view of a first alternative embodiment of the second erectile band, showing our new design;
 FIG. 37 is a front elevational view thereof;
 FIG. 38 is a back elevational view thereof;
 FIG. 39 is a right side elevational view thereof;
 FIG. 40 is a left side elevational view thereof;
 FIG. 41 is a top plan view thereof;
 FIG. 42 is a bottom plan view thereof;
 FIG. 43 is a top, front, right perspective view of a second alternative embodiment of the second erectile band, showing our new design;
 FIG. 44 is a front elevational view thereof;
 FIG. 45 is a back elevational view thereof;
 FIG. 46 is a right side elevational view thereof;
 FIG. 47 is a left side elevational view thereof;
 FIG. 48 is a top plan view thereof;
 FIG. 49 is a bottom plan view thereof;
 FIG. 50 is a top, front, right perspective view of a third alternative embodiment of the second erectile band, showing our new design;
 FIG. 51 is a front elevational view thereof;
 FIG. 52 is a back elevational view thereof;
 FIG. 53 is a right side elevational view thereof;
 FIG. 54 is a left side elevational view thereof;
 FIG. 55 is a top plan view thereof;
 FIG. 56 is a bottom plan view thereof;
 FIG. 57 is a top, front, right perspective view of a third erectile band, showing our new design;
 FIG. 58 is a front elevational view thereof;
 FIG. 59 is a back elevational view thereof;
 FIG. 60 is a right side elevational view thereof;
 FIG. 61 is a left side elevational view thereof;
 FIG. 62 is a top plan view thereof;
 FIG. 63 is a bottom plan view thereof;
 FIG. 64 is a top, front, right perspective view of a first alternative embodiment of the third erectile band, showing our new design;
 FIG. 65 is a front elevational view thereof;
 FIG. 66 is a back elevational view thereof;
 FIG. 67 is a right side elevational view thereof;
 FIG. 68 is a left side elevational view thereof;
 FIG. 69 is a top plan view thereof; and,
 FIG. 70 is a bottom plan view thereof.

The dash-dot broken lines in the drawings are for the purpose of illustrating a boundary line which form no part of the claimed design.

1 Claim, 70 Drawing Sheets

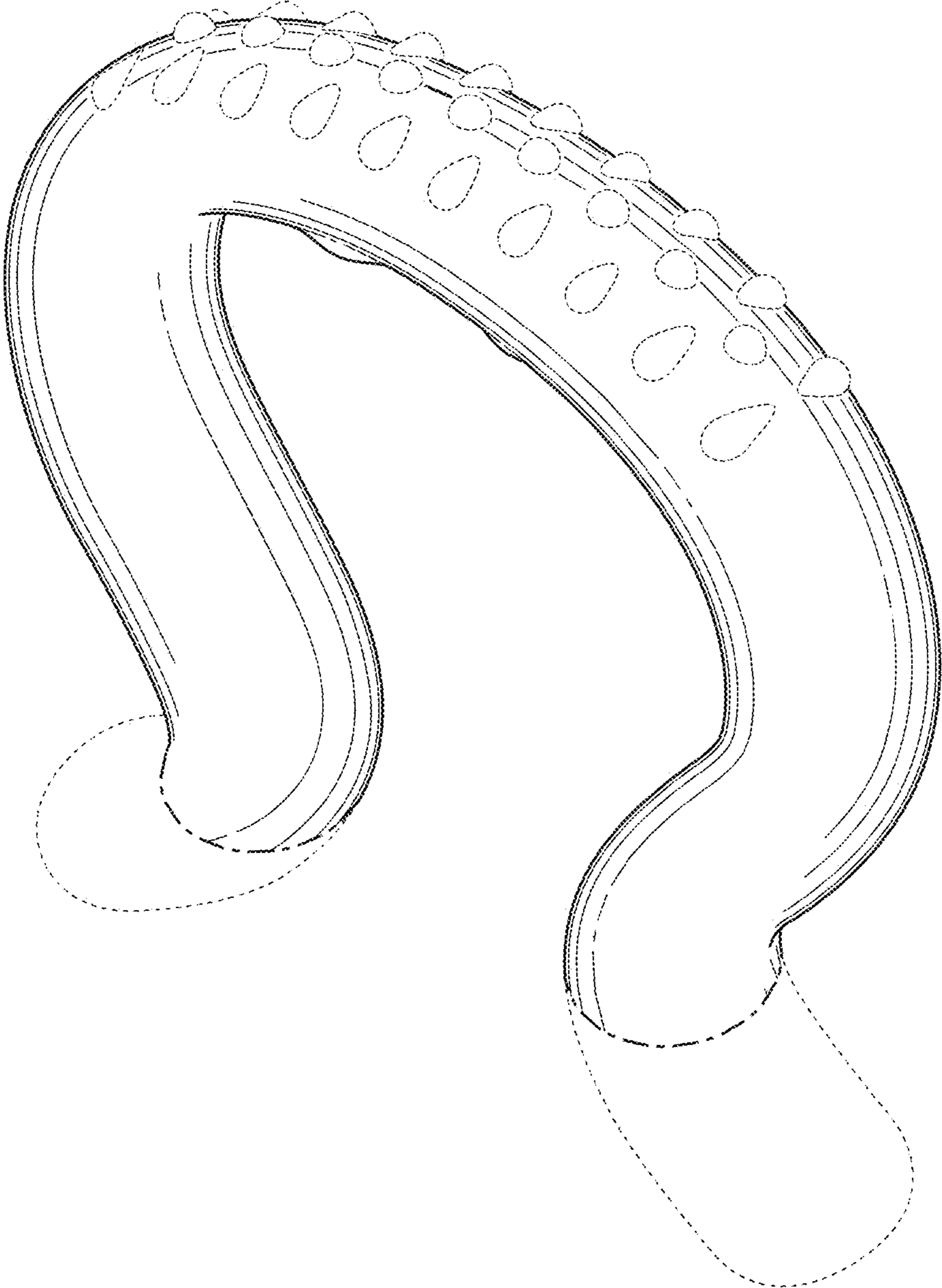

FIG. 1

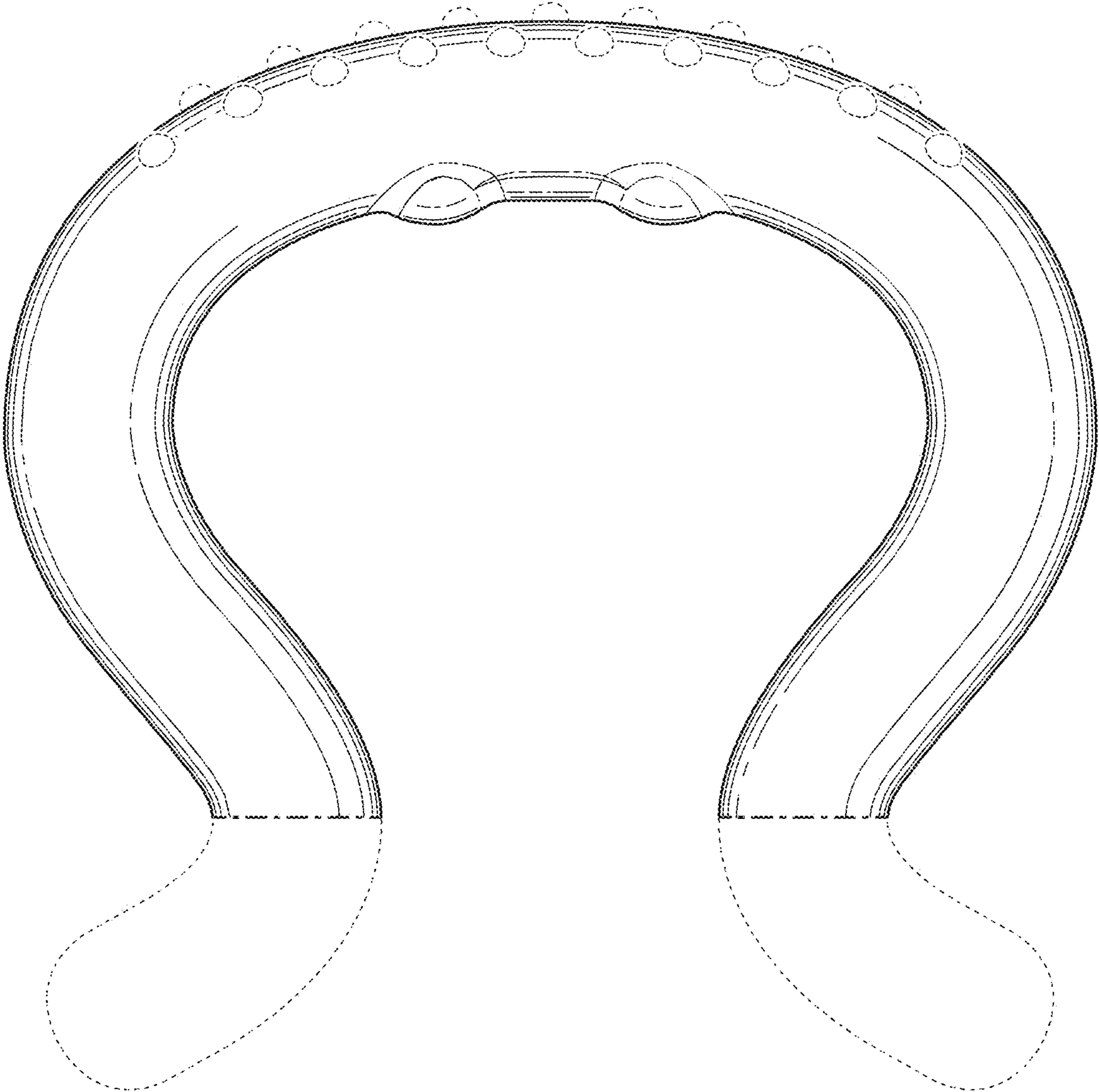

FIG. 2

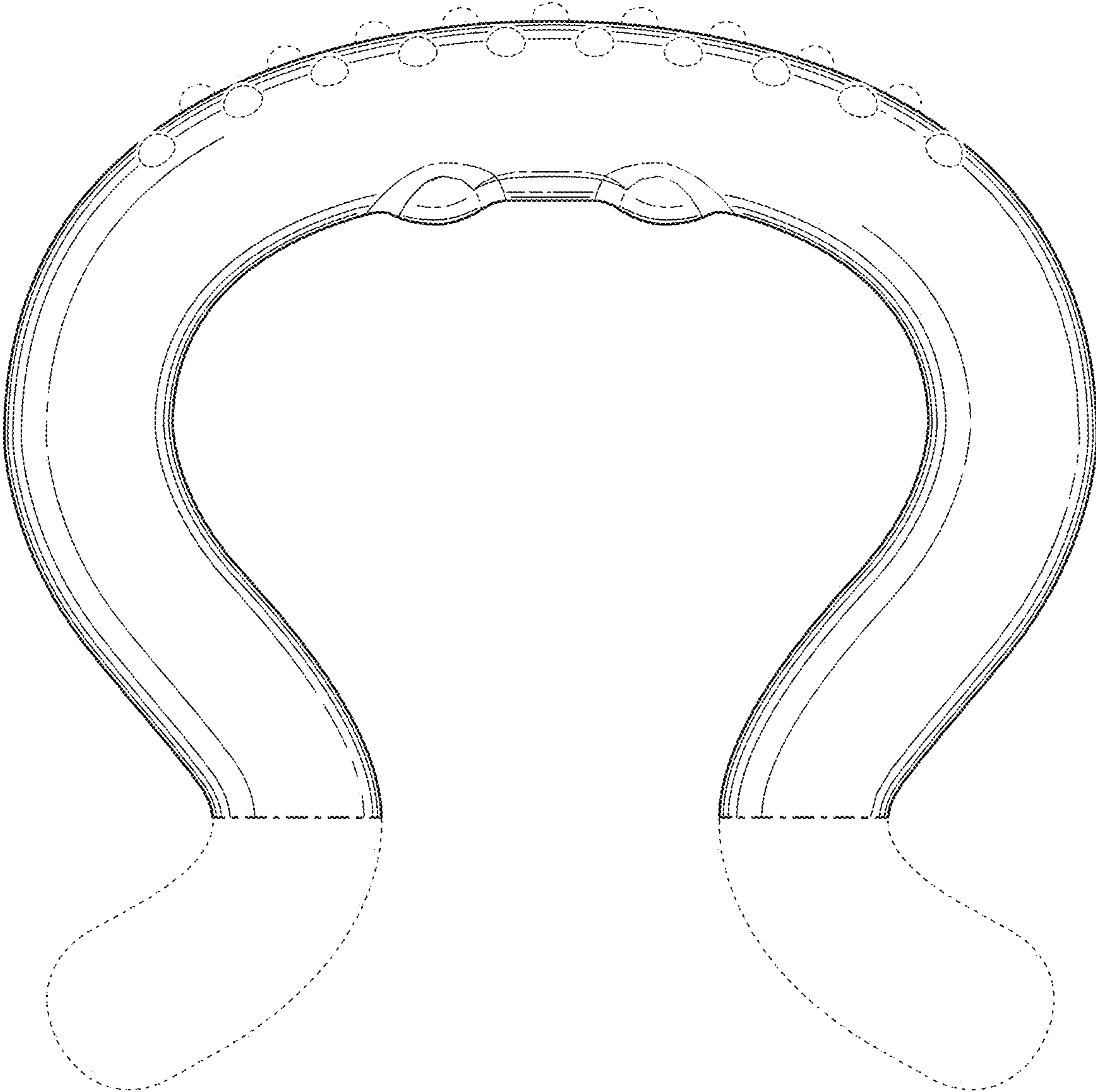

FIG. 3

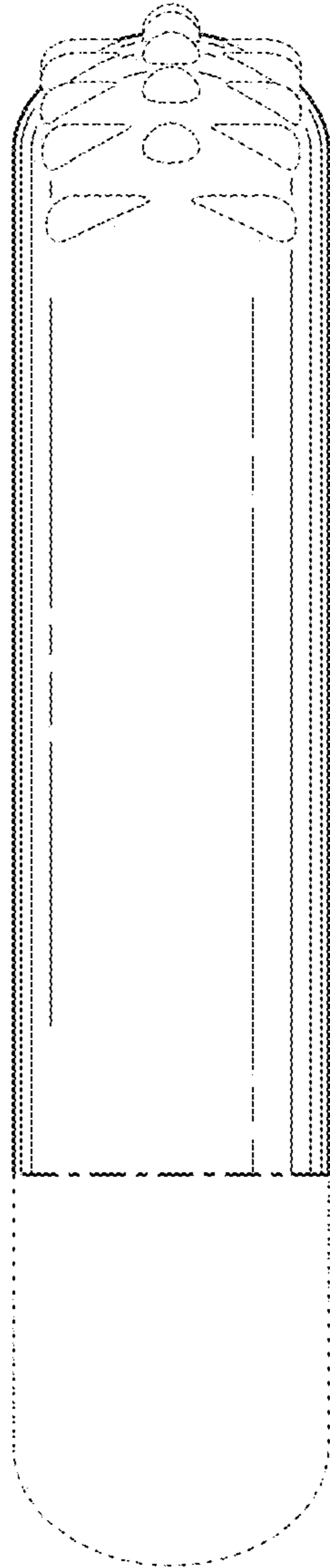

FIG. 4

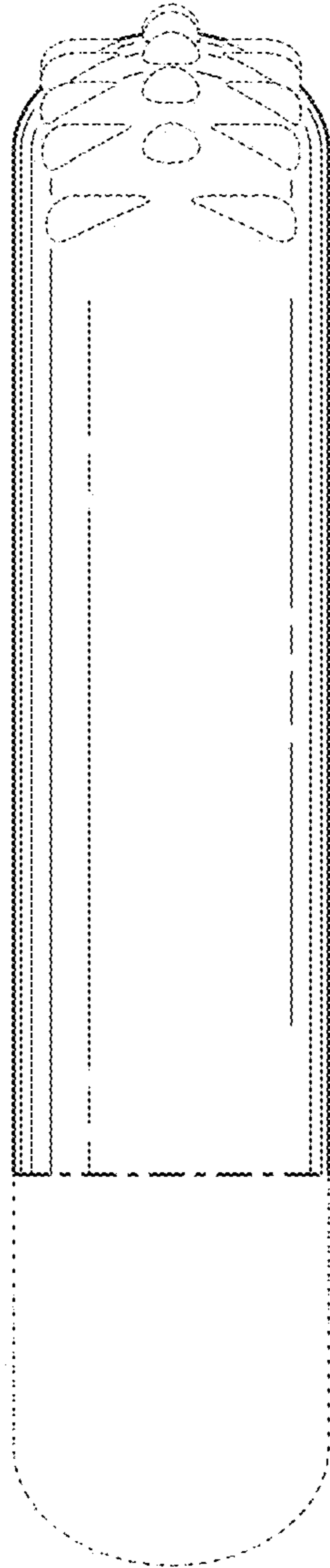

FIG. 5

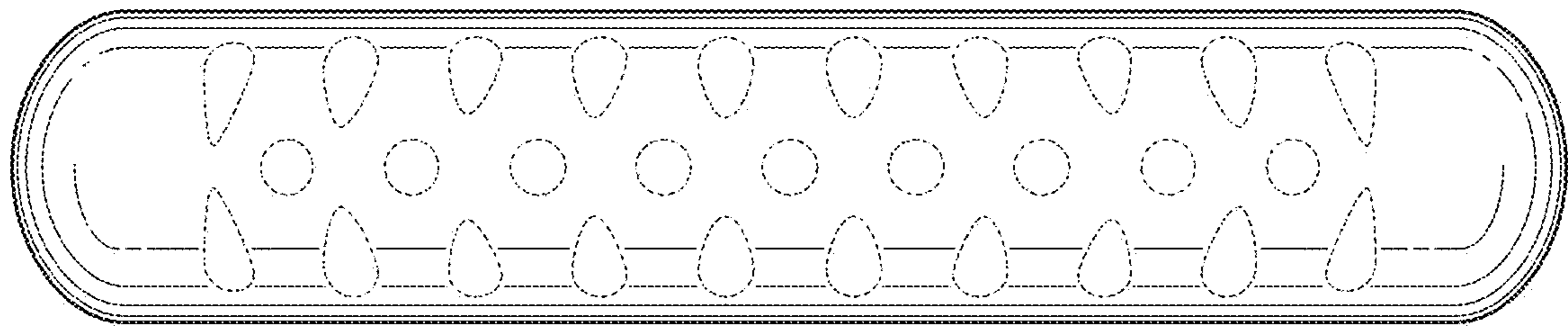

FIG. 6

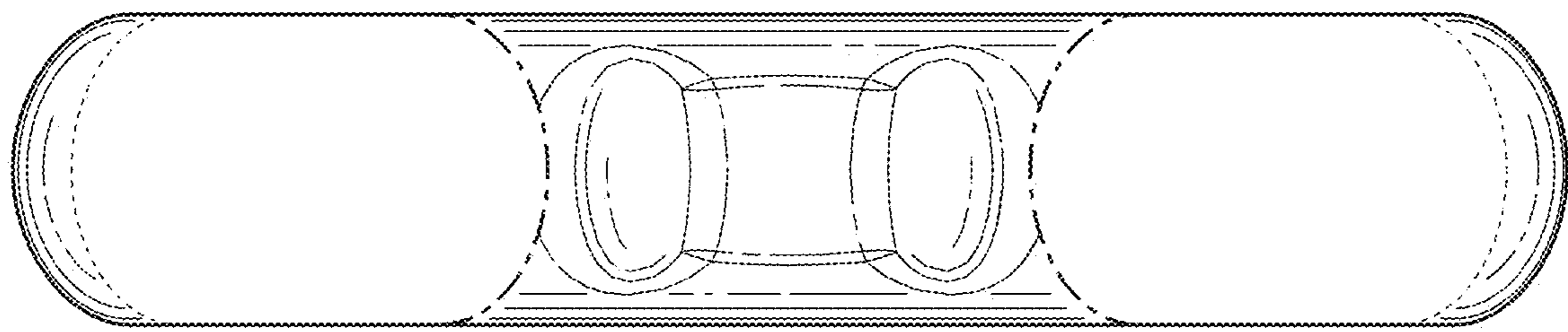

FIG. 7

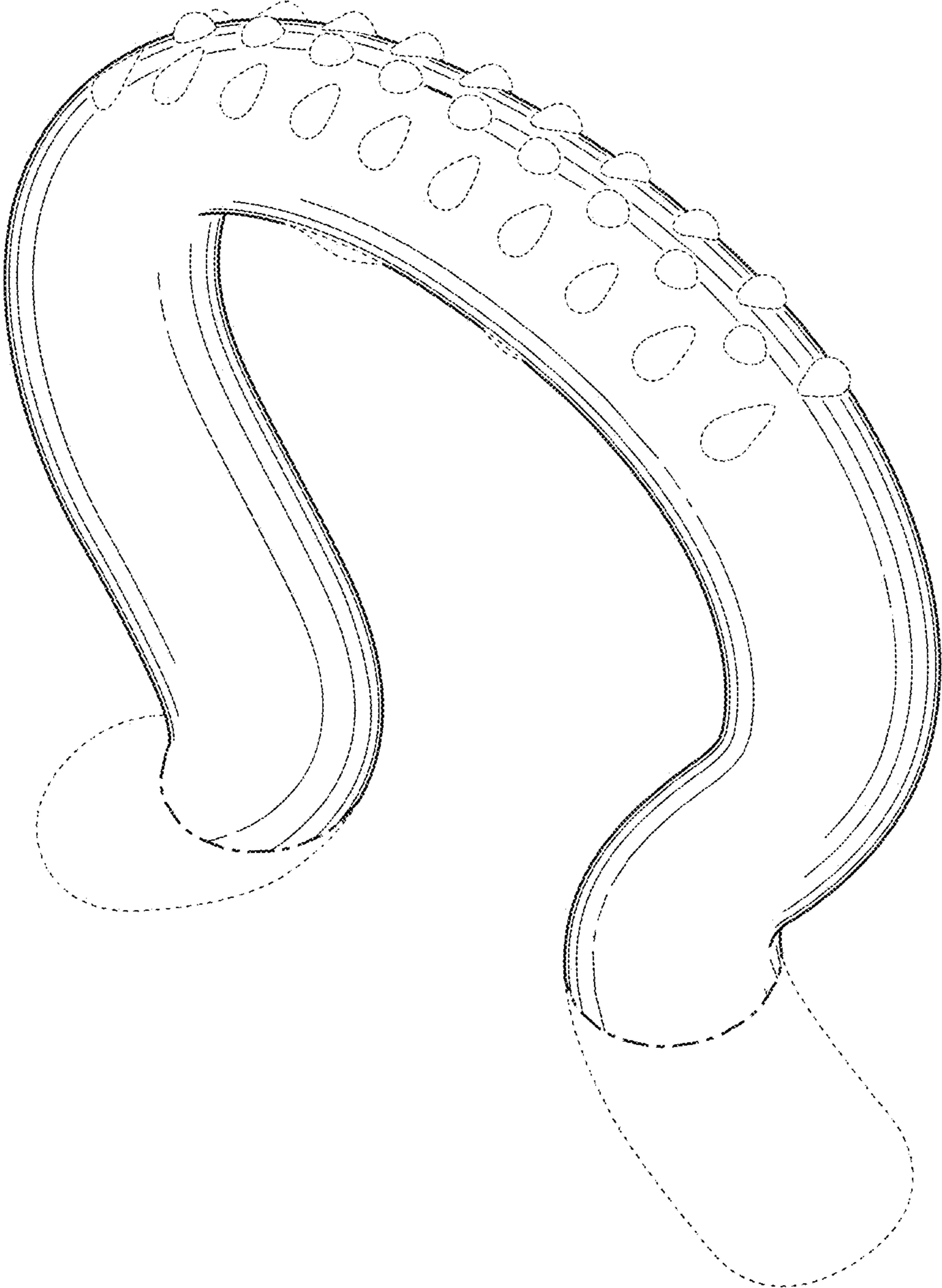

FIG. 8

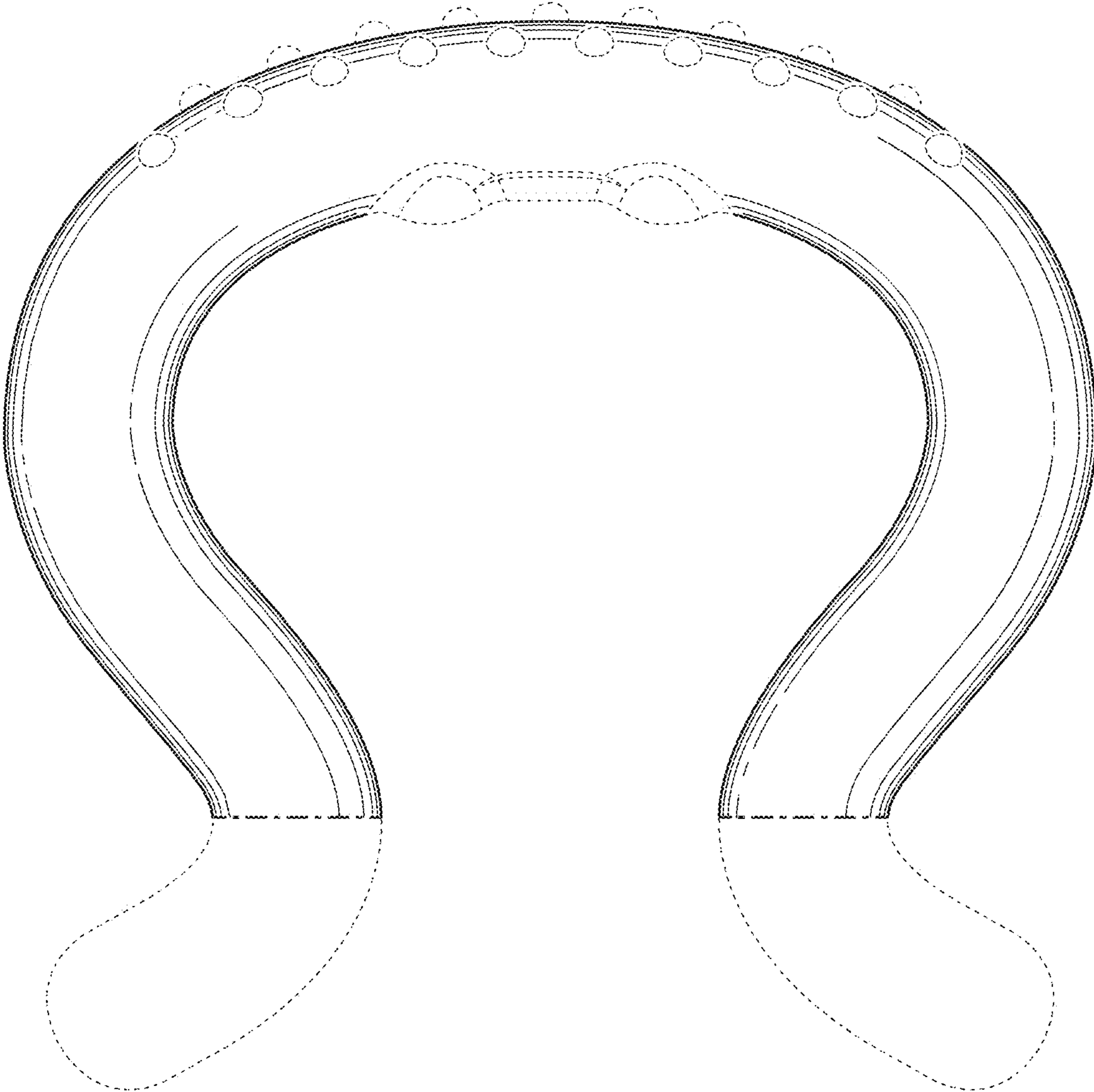

FIG. 9

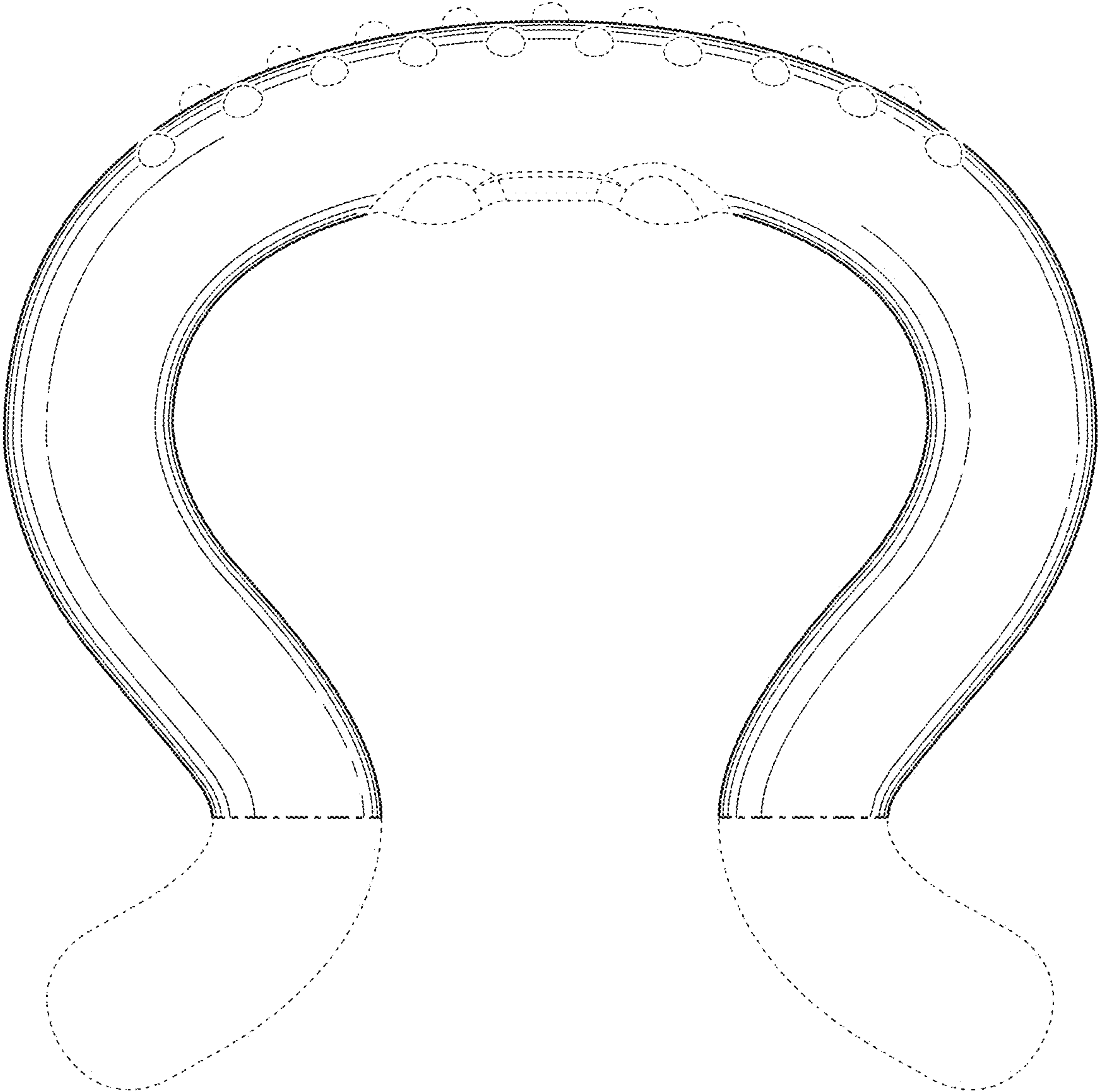

FIG. 10

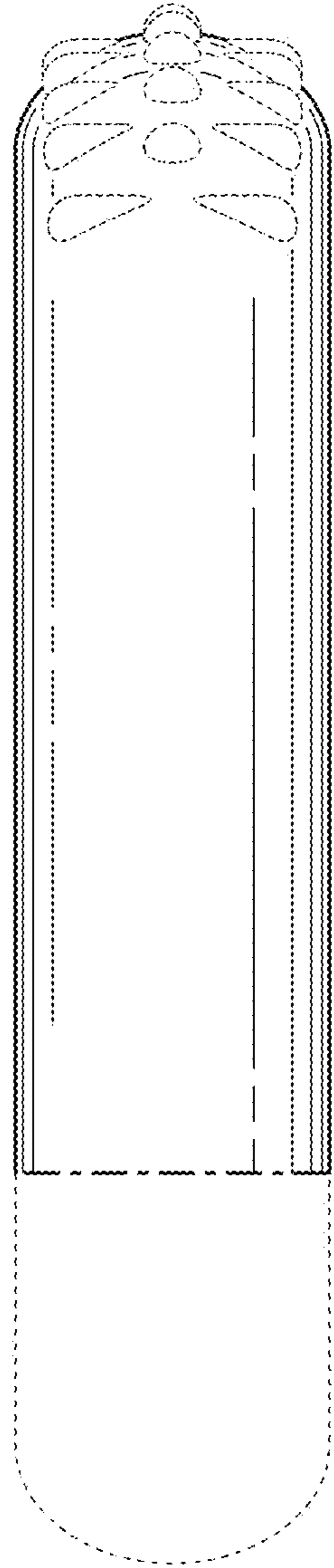

FIG. 11

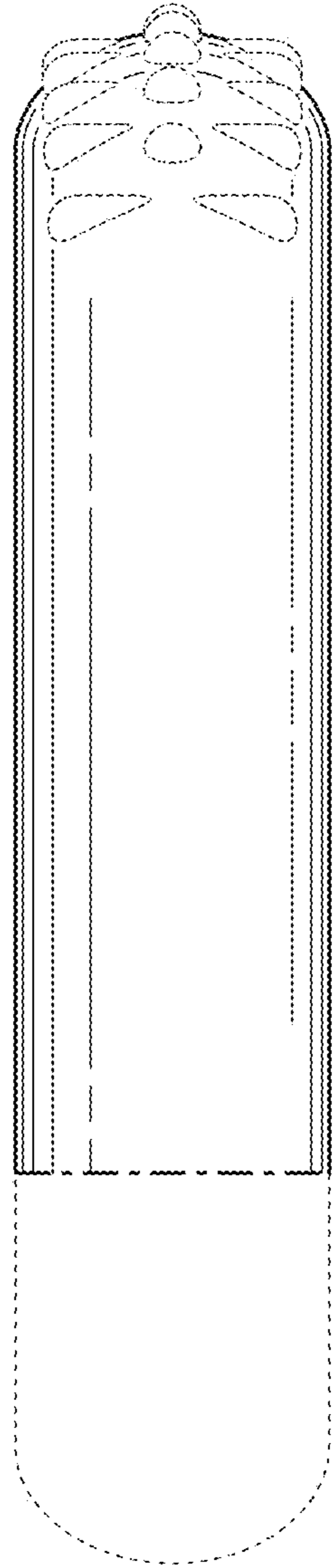

FIG. 12

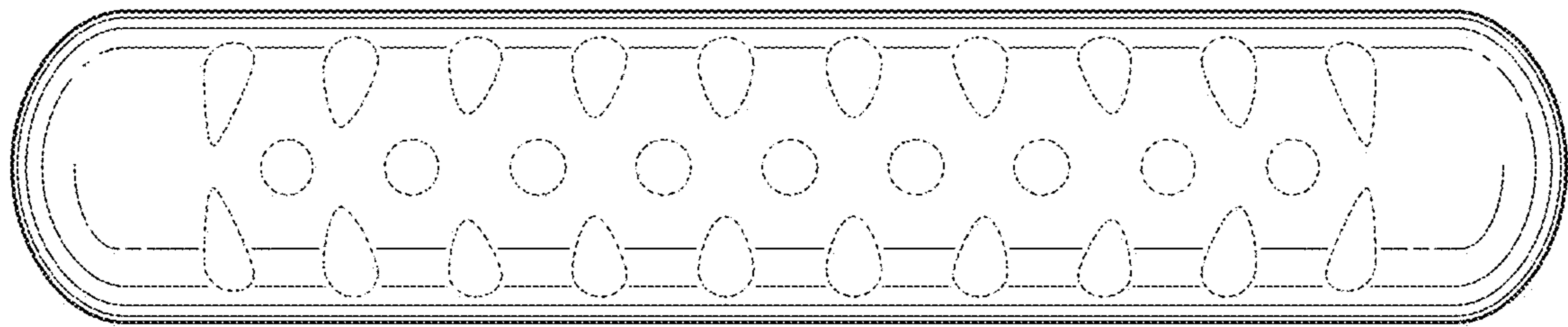

FIG. 13

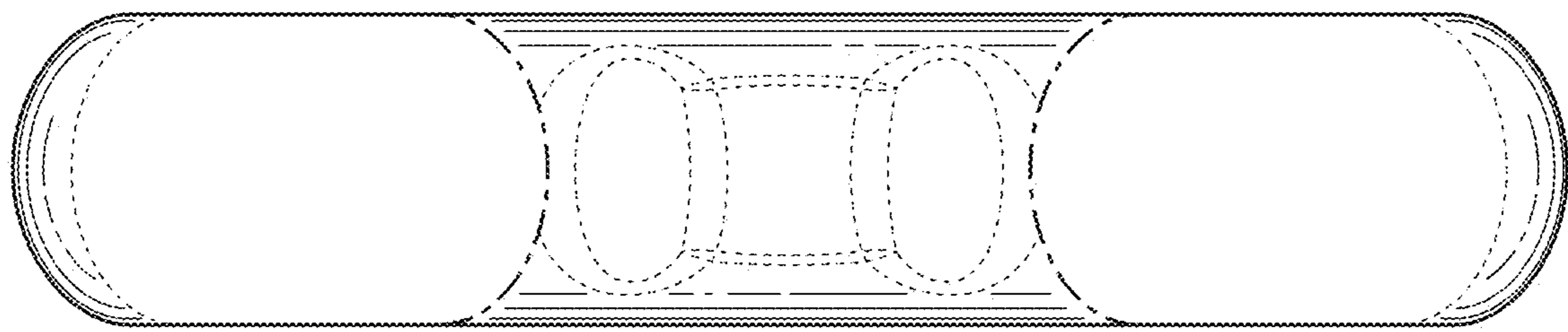

FIG. 14

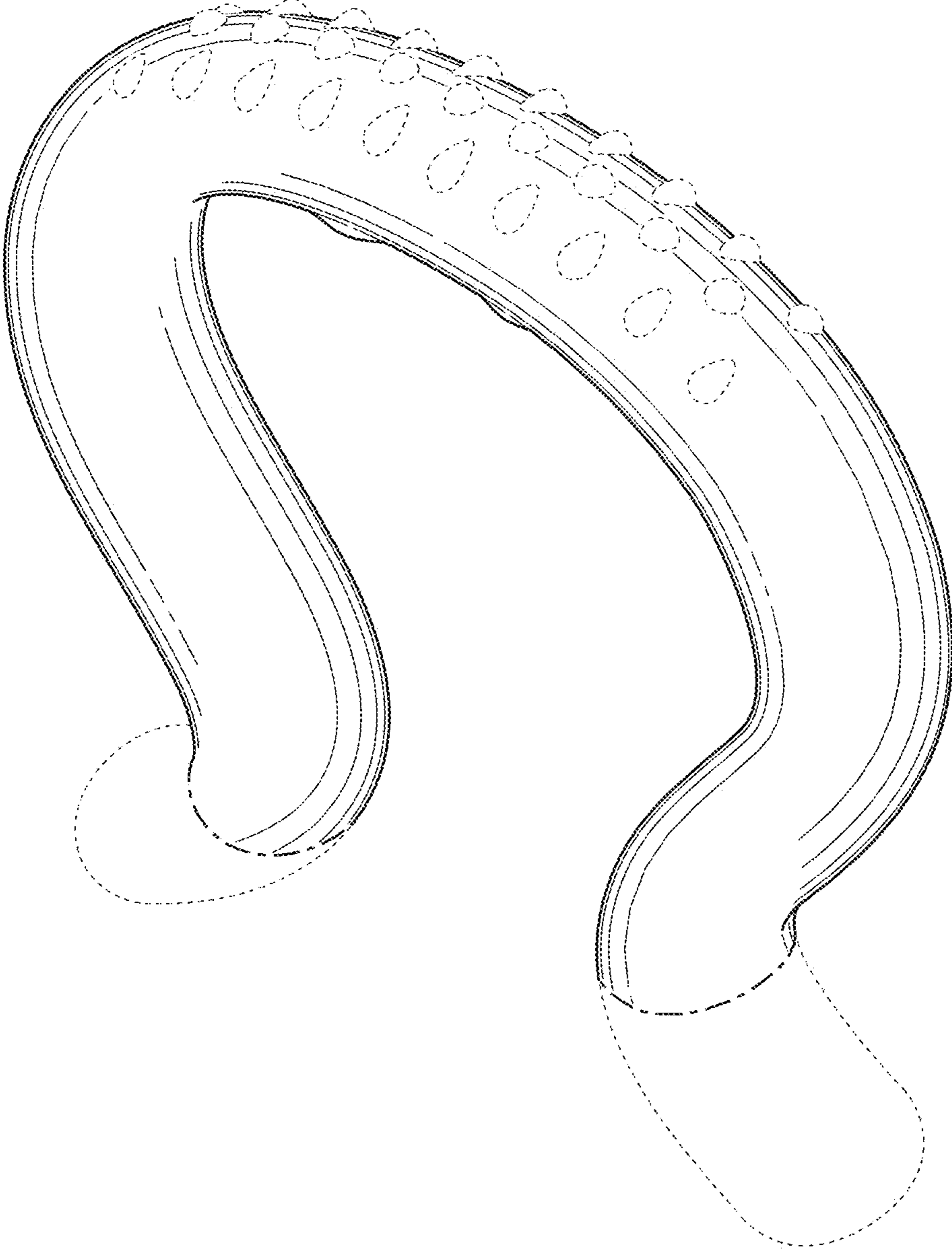

FIG. 15

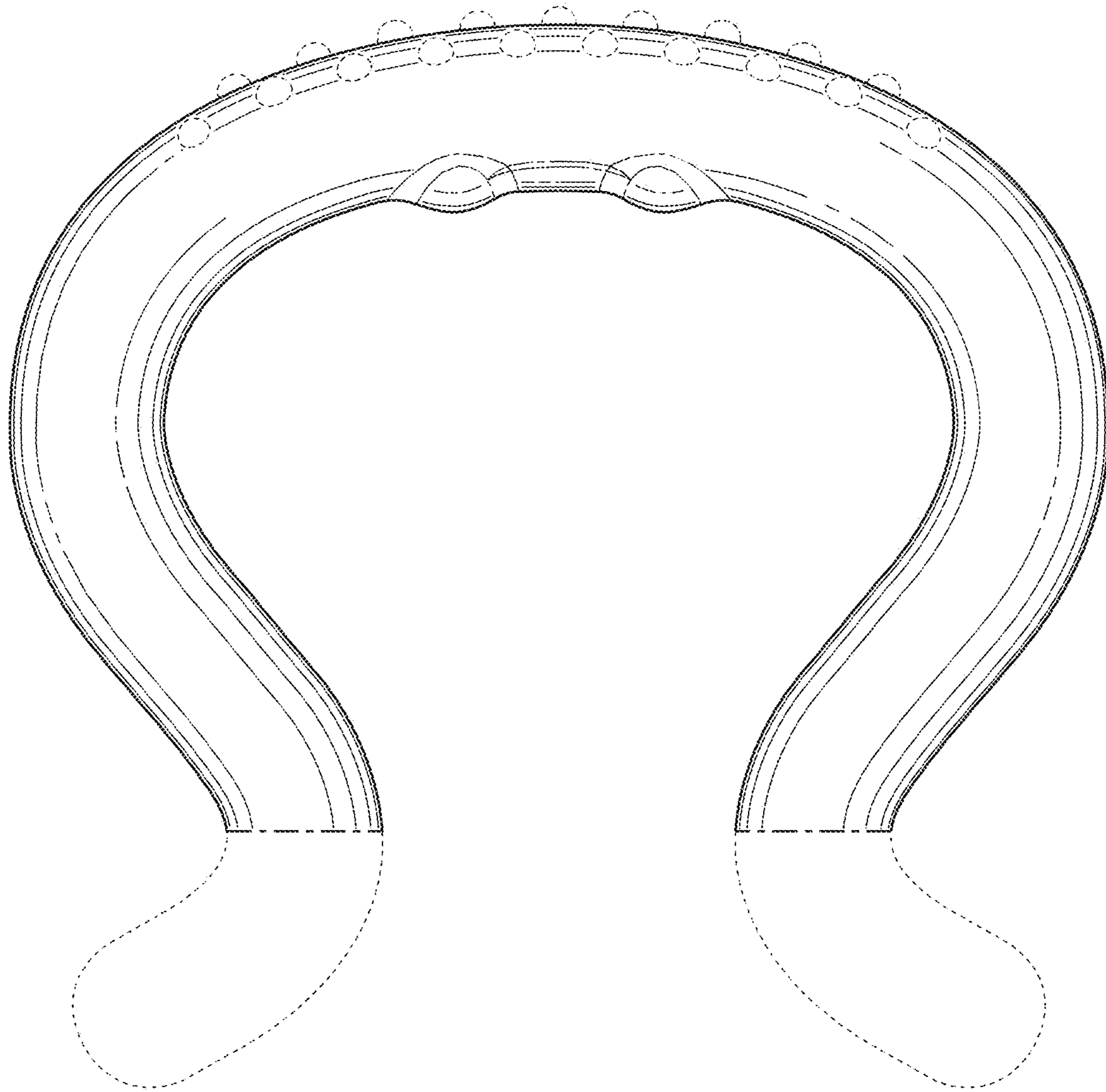

FIG. 16

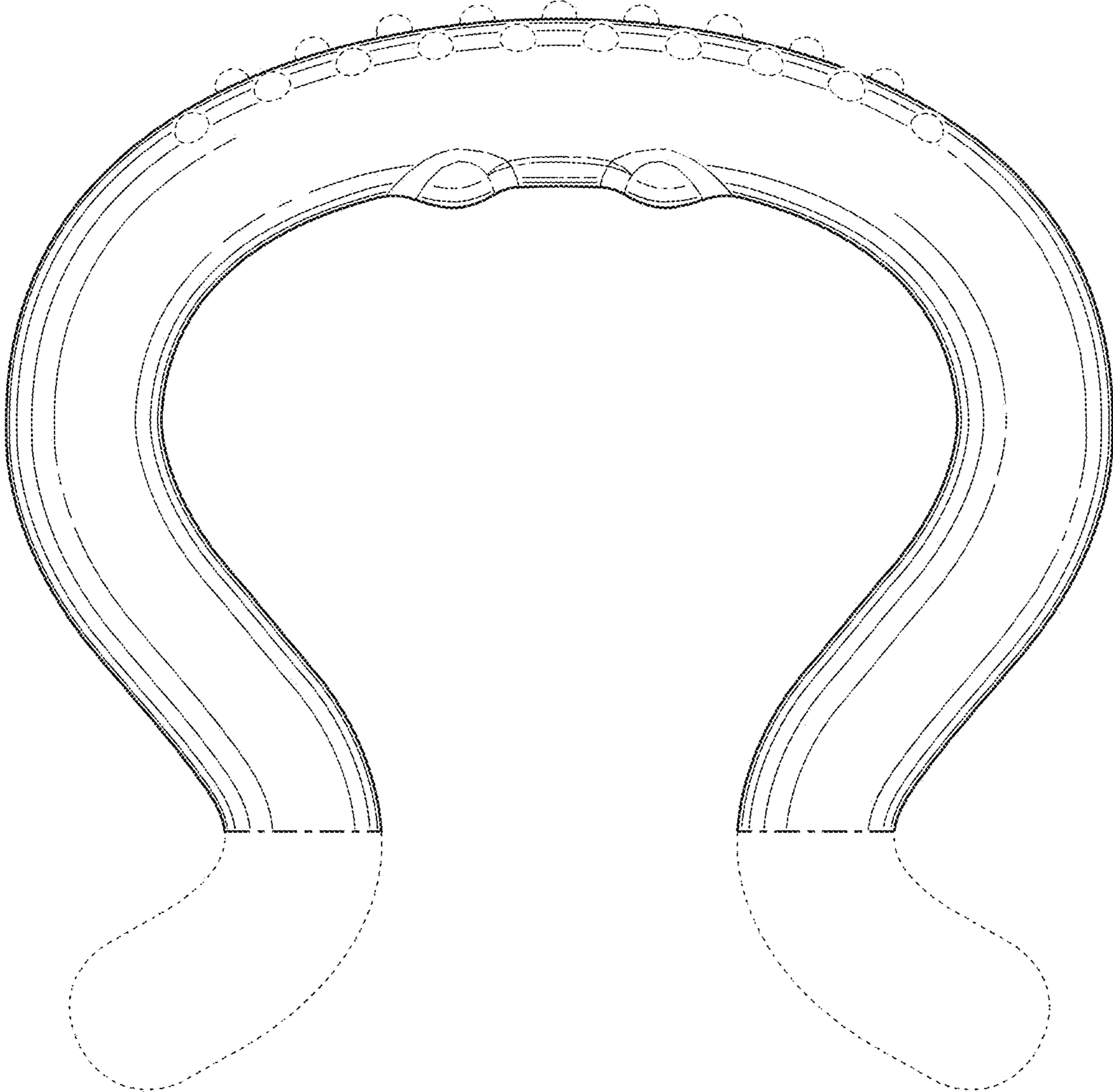

FIG. 17

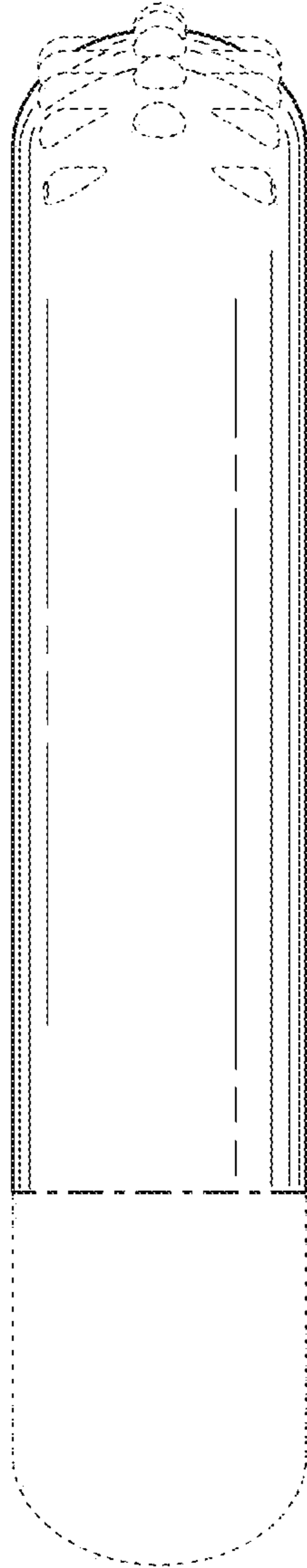

FIG. 18

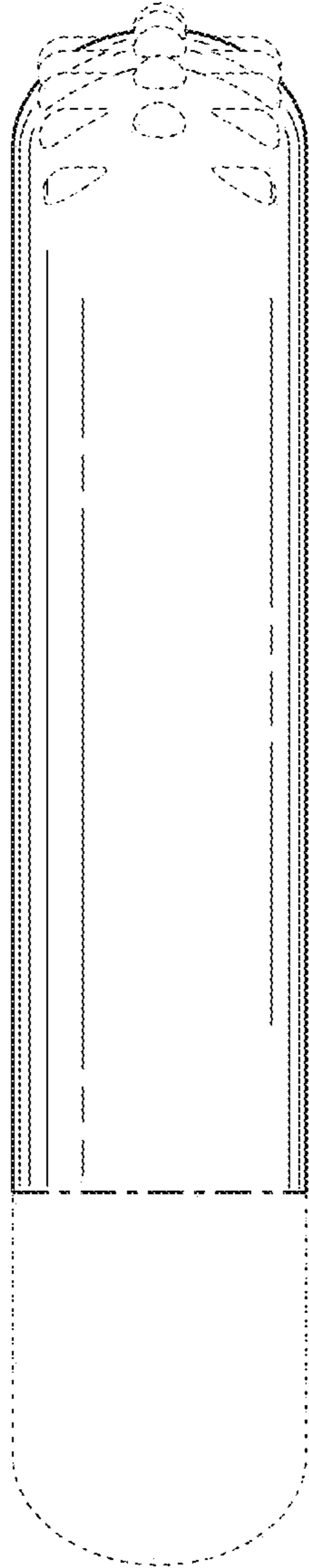

FIG. 19

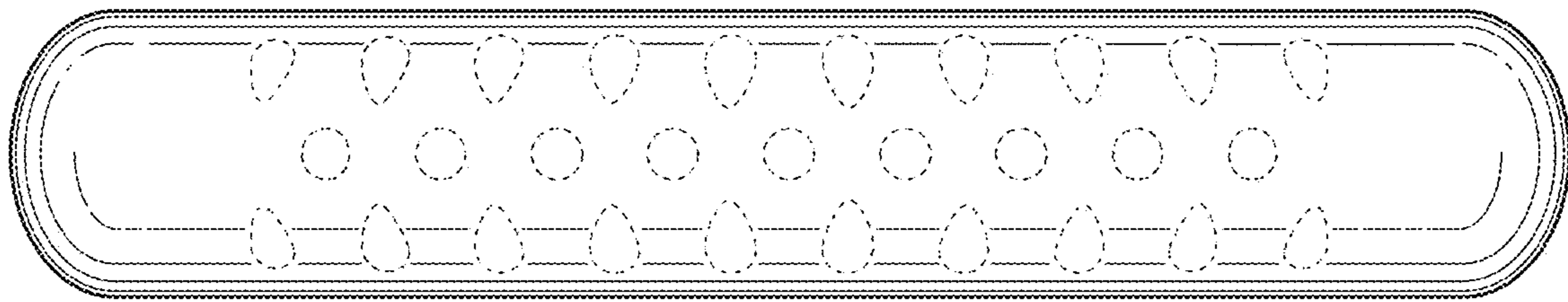

FIG. 20

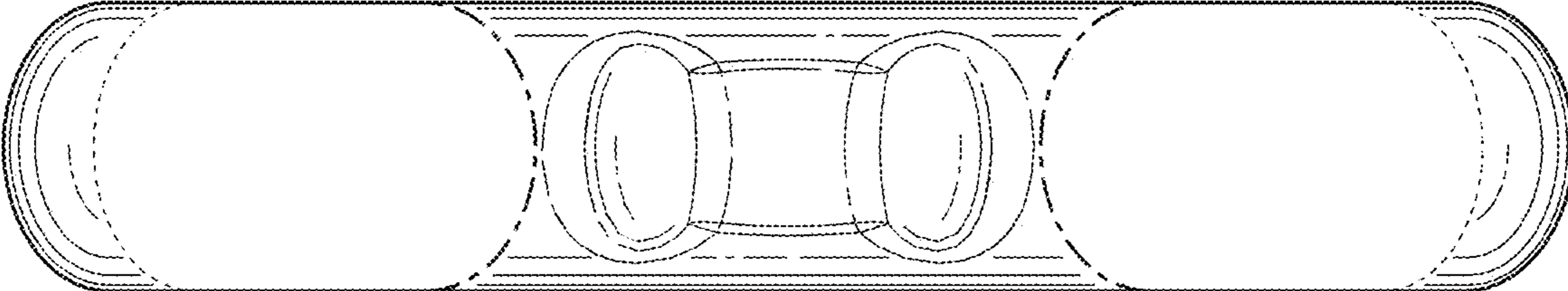

FIG. 21

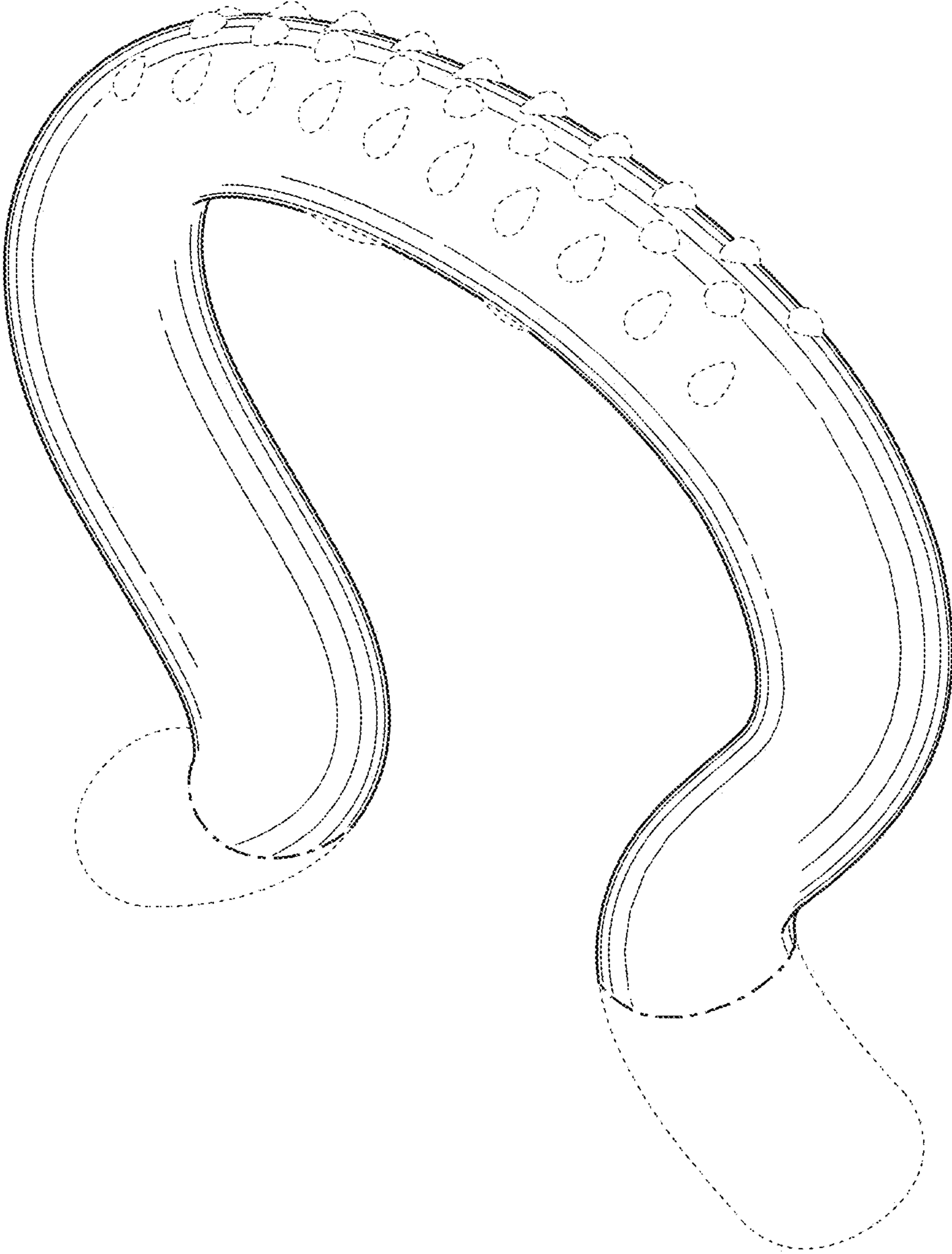

FIG. 22

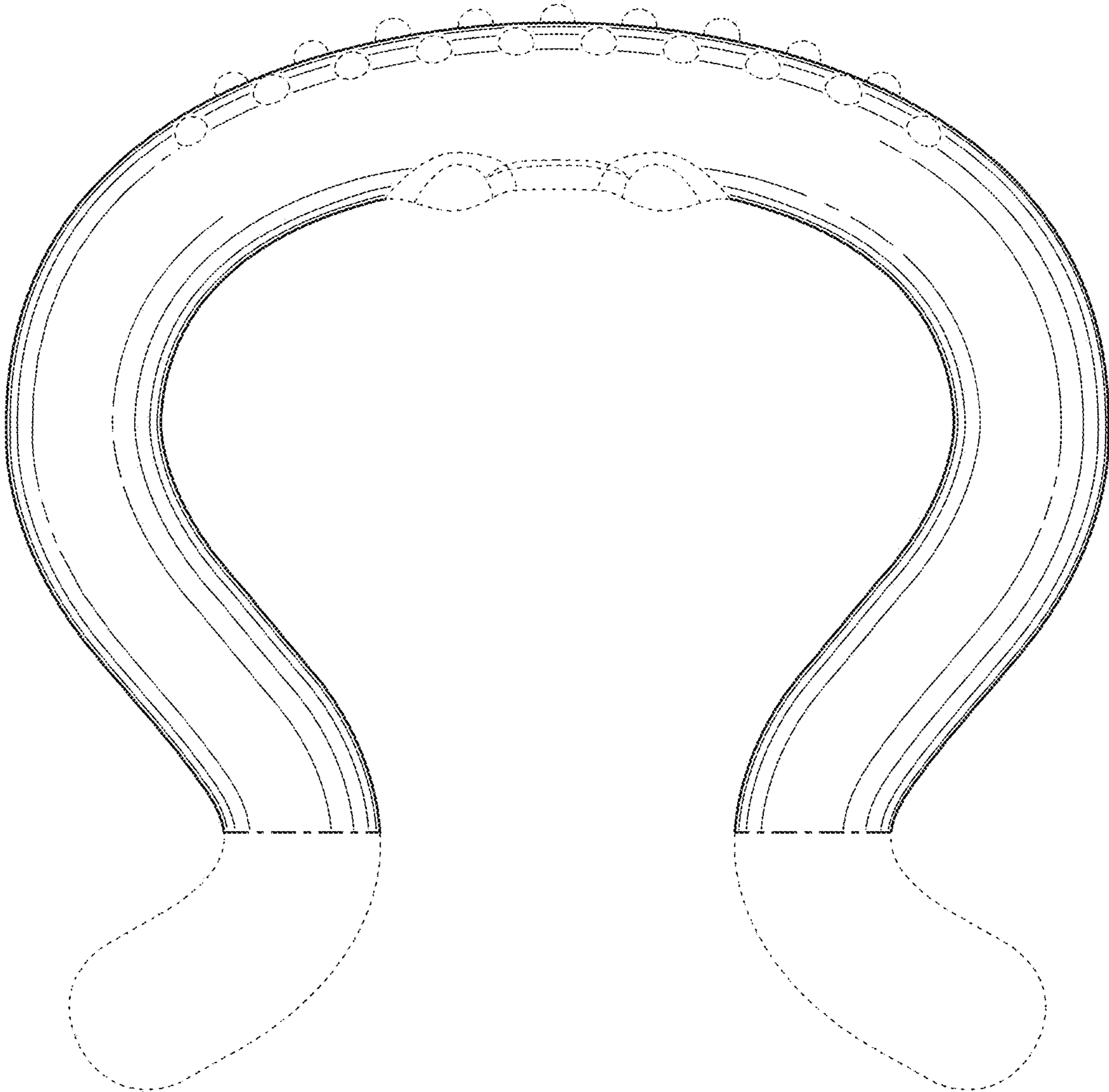

FIG. 23

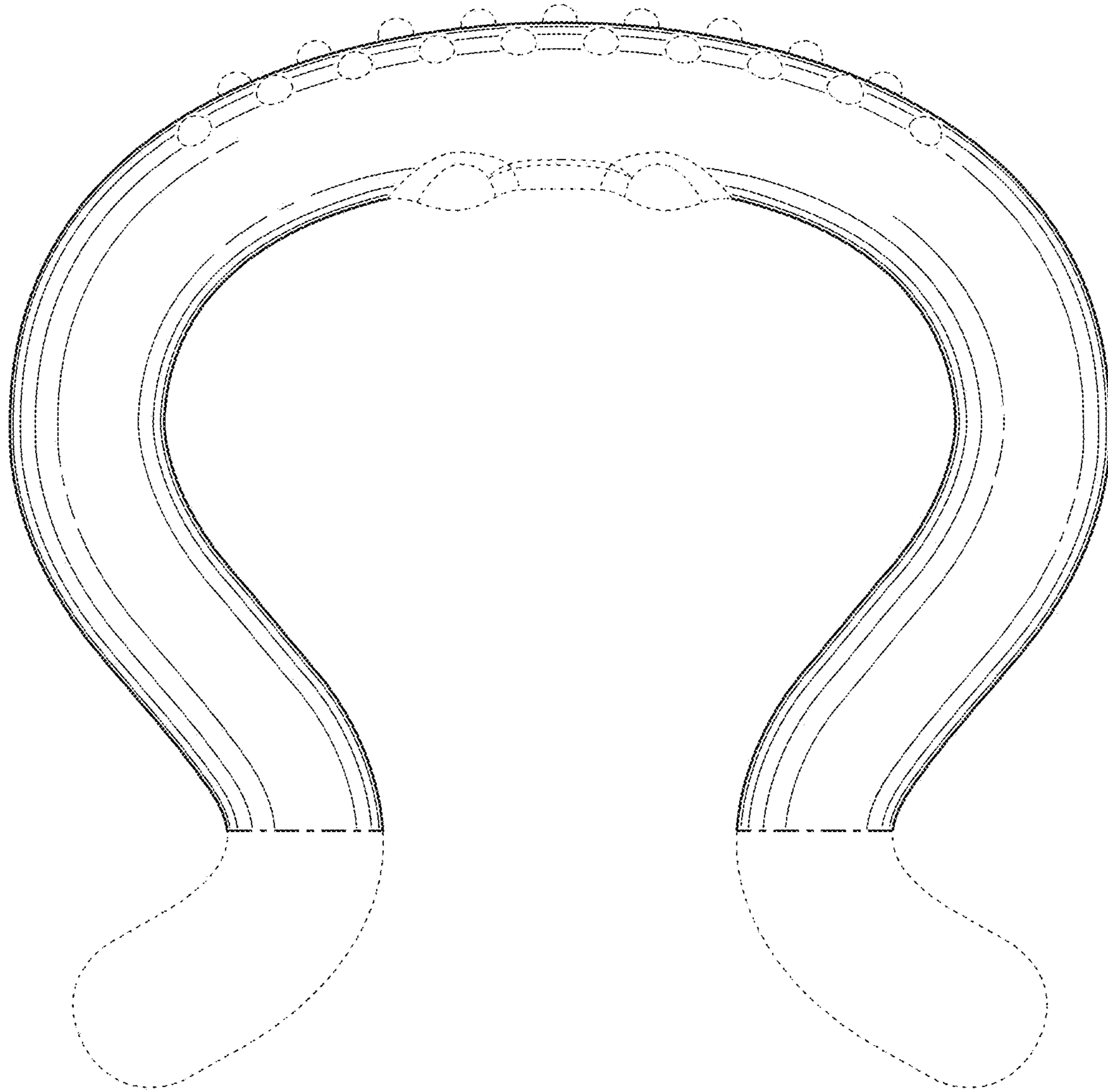

FIG. 24

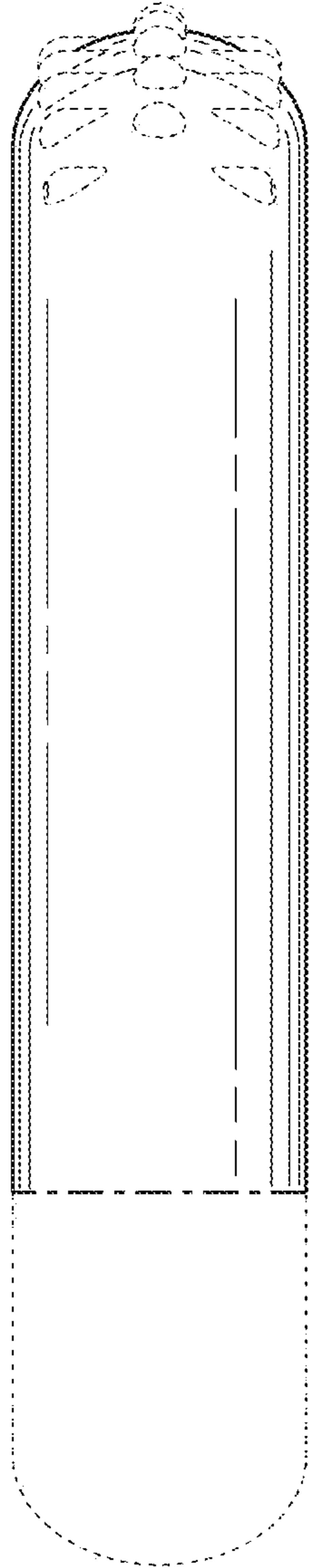

FIG. 25

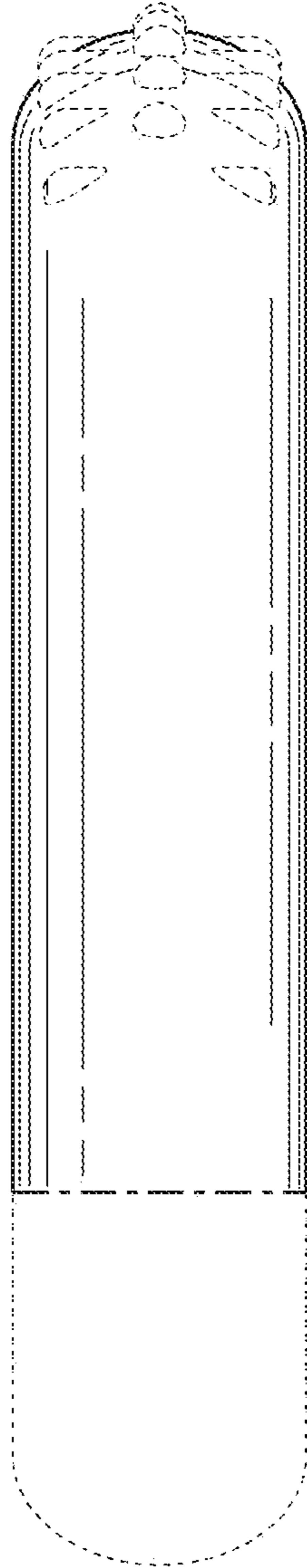

FIG. 26

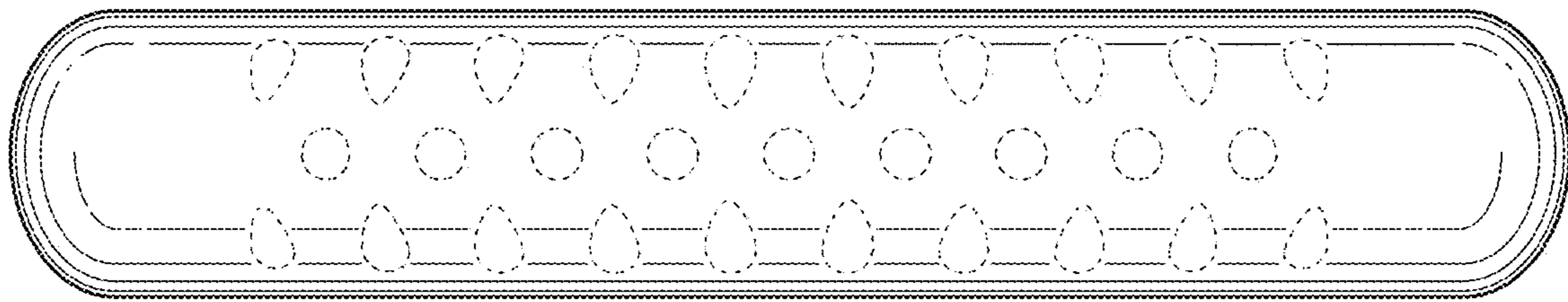

FIG. 27

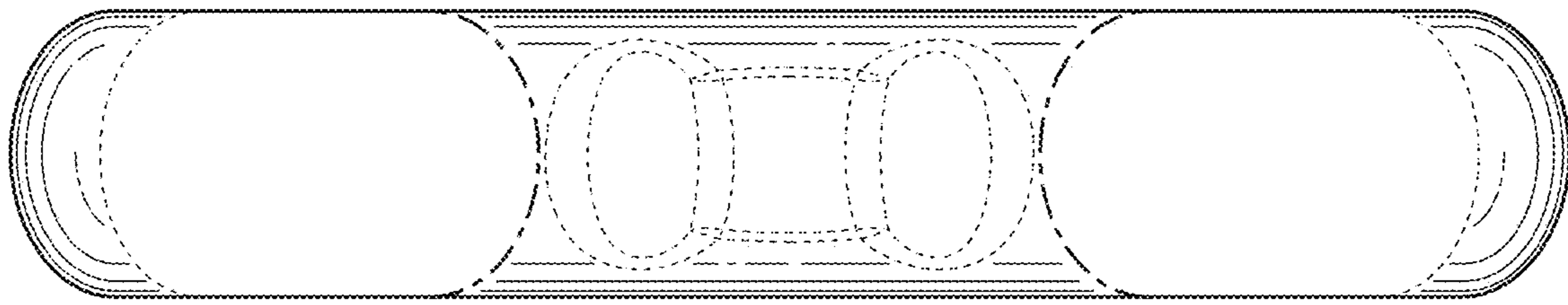

FIG. 28

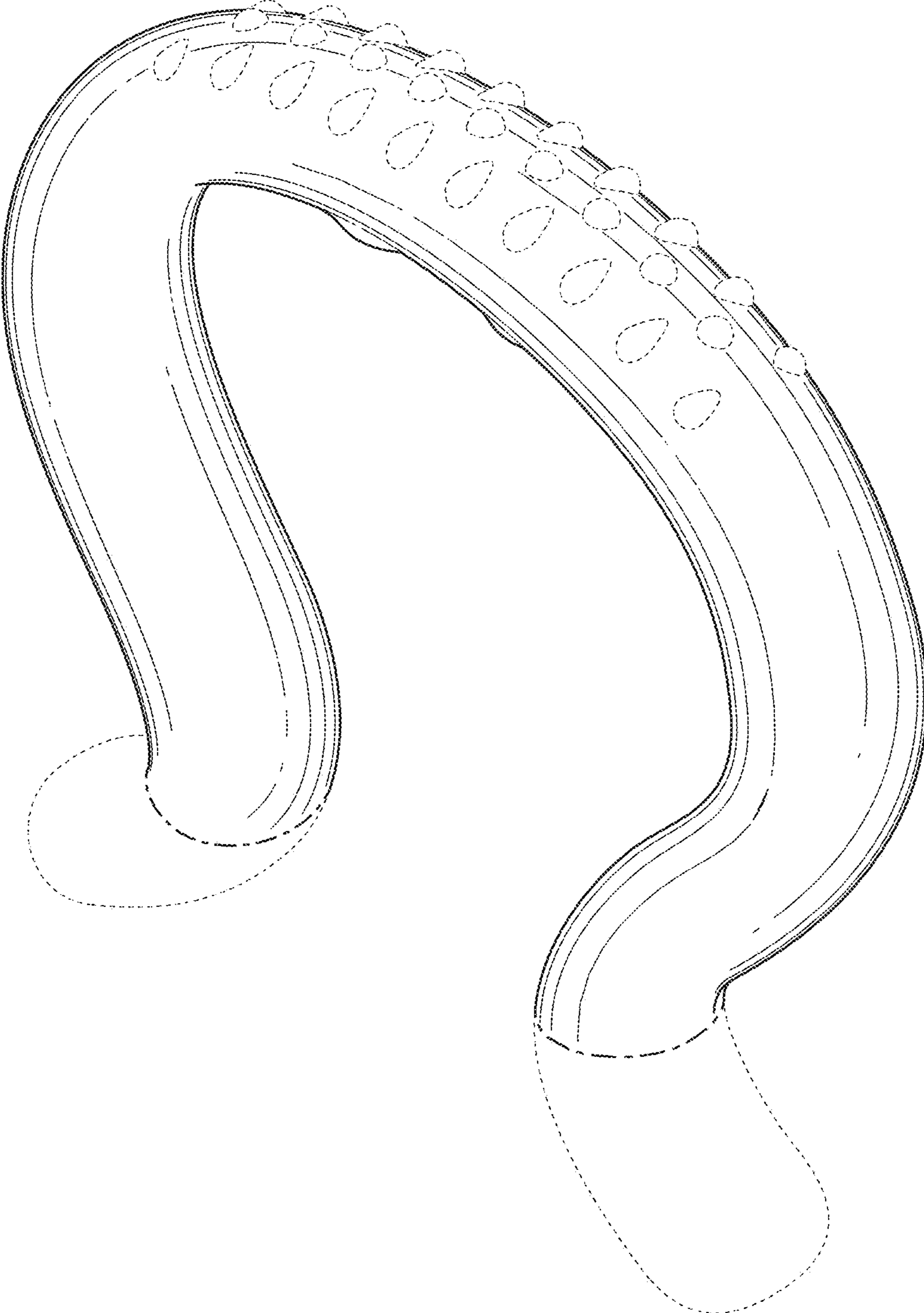

FIG. 29

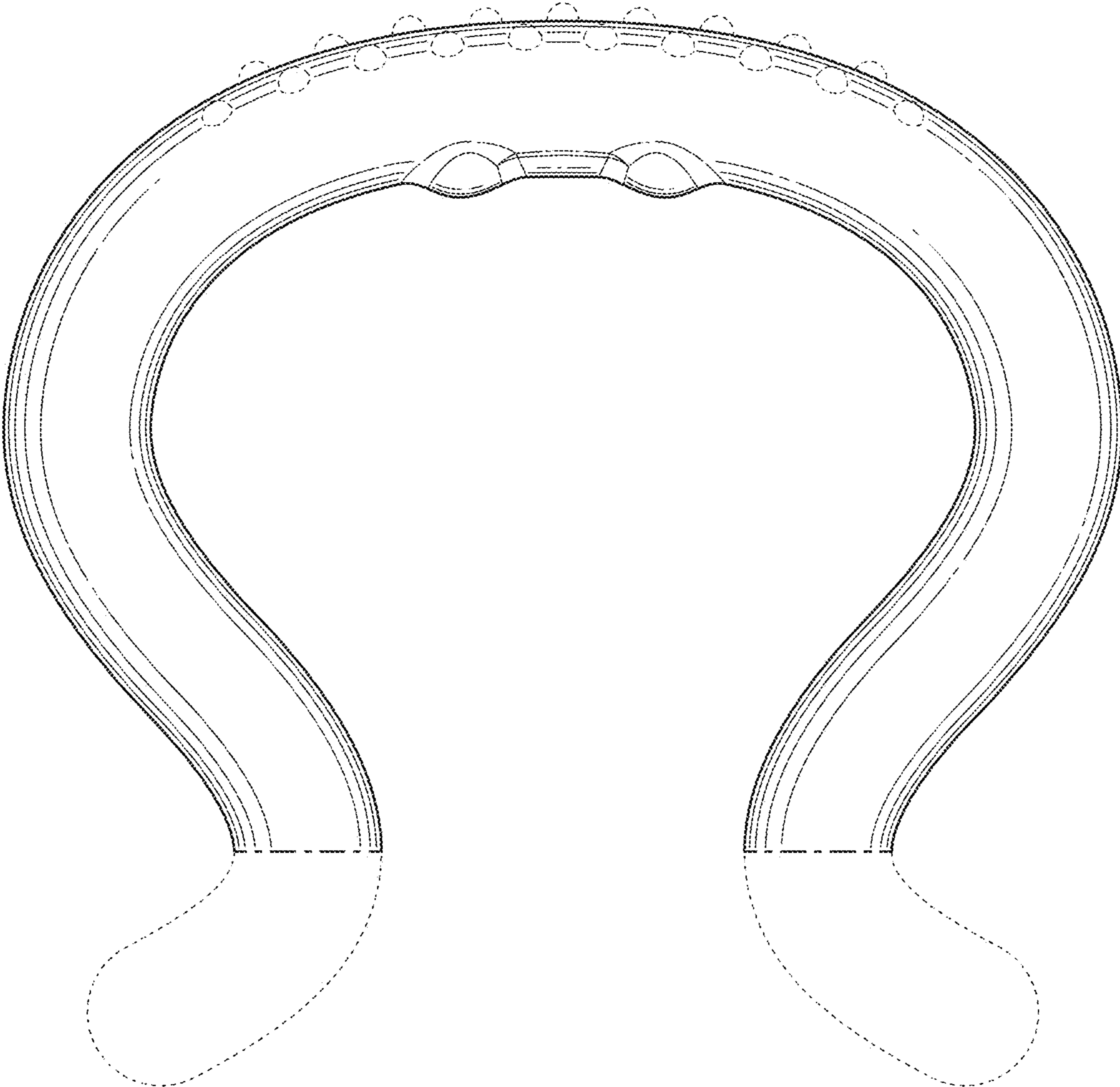

FIG. 30

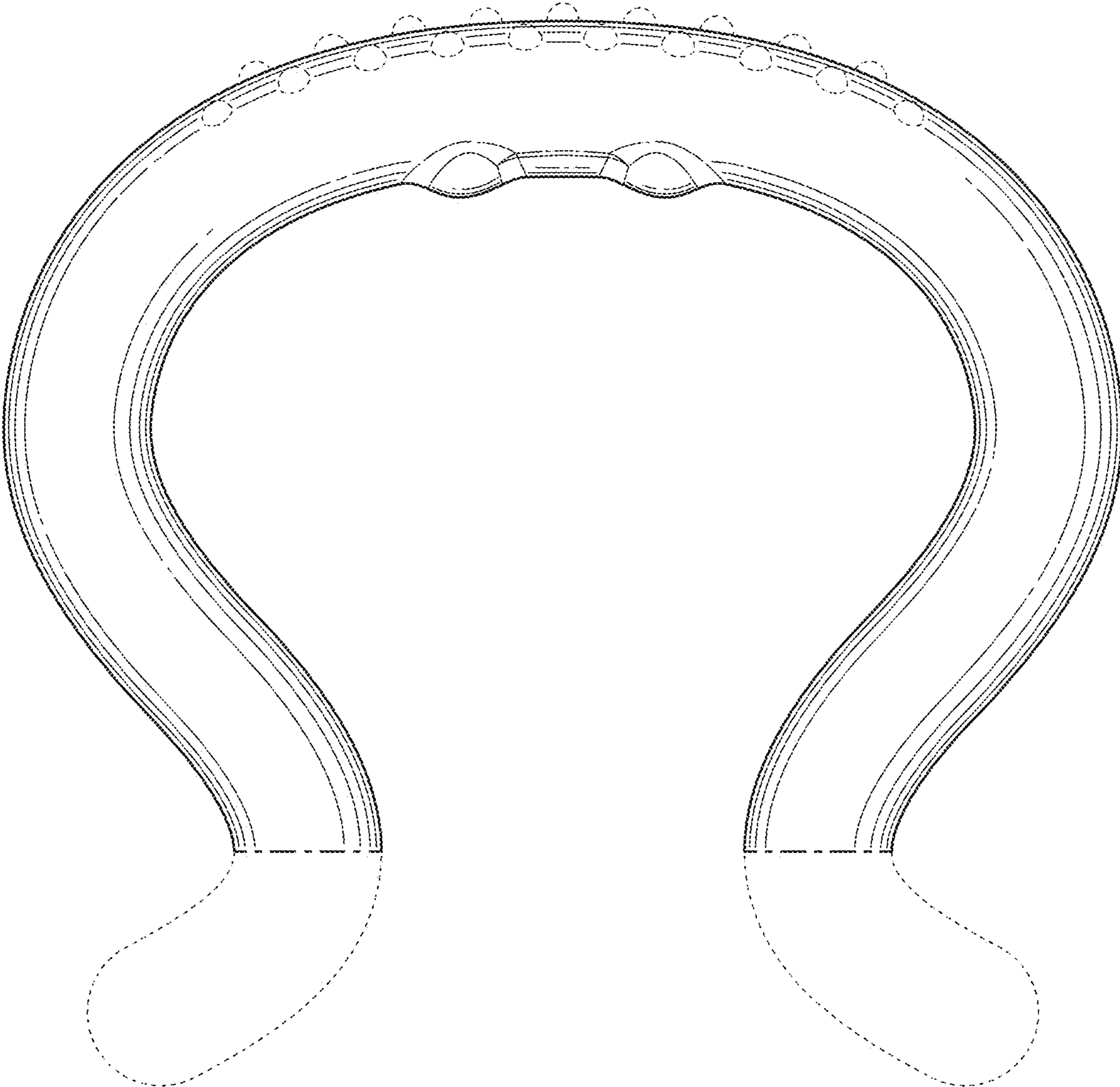

FIG. 31

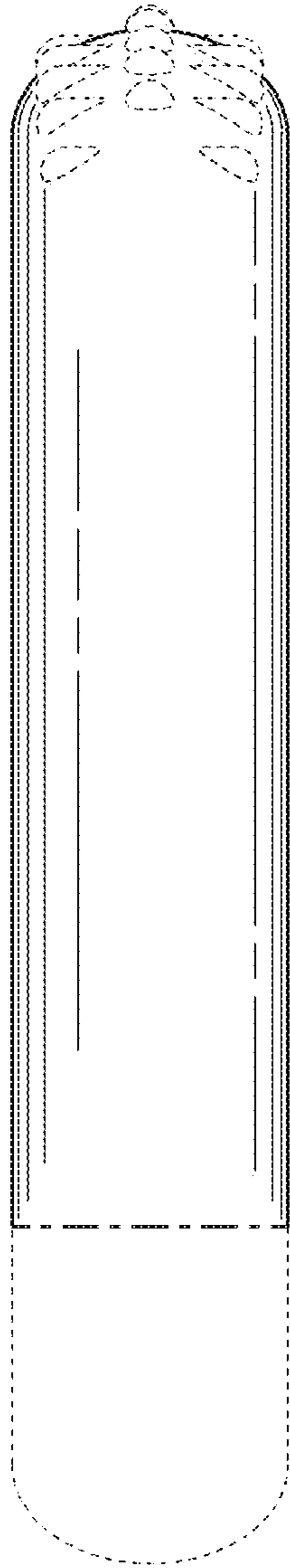

FIG. 32

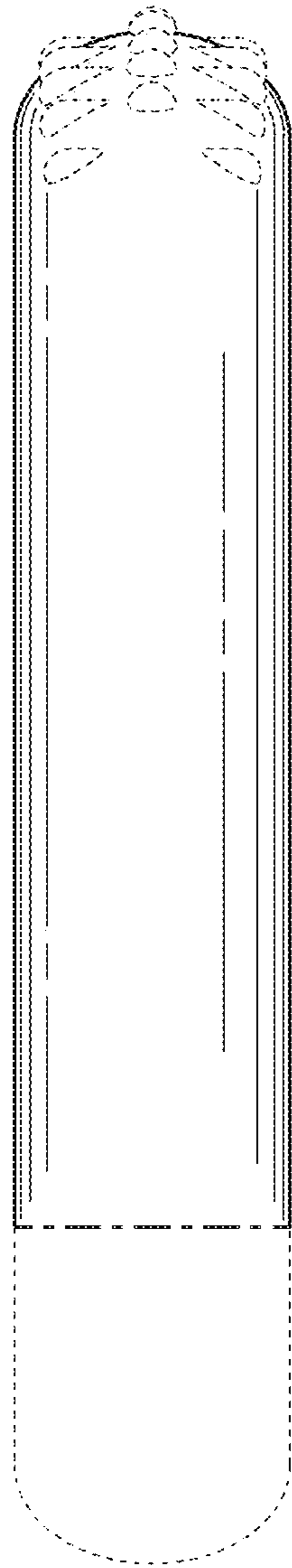

FIG. 33

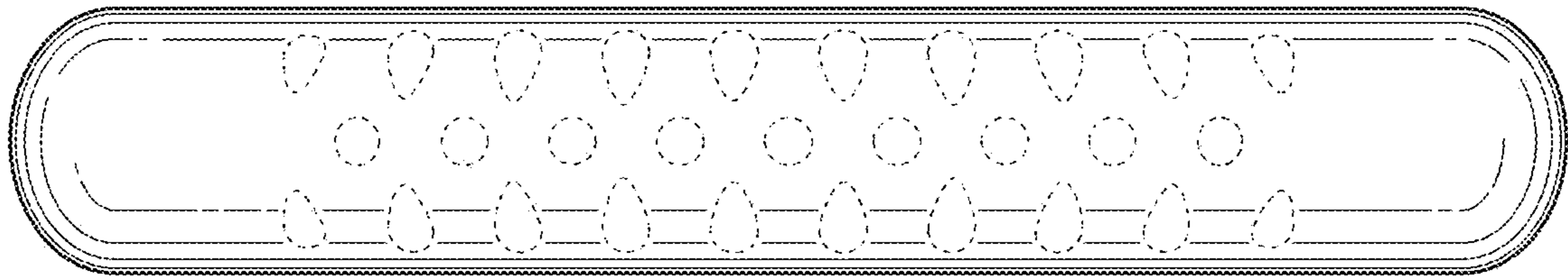

FIG. 34

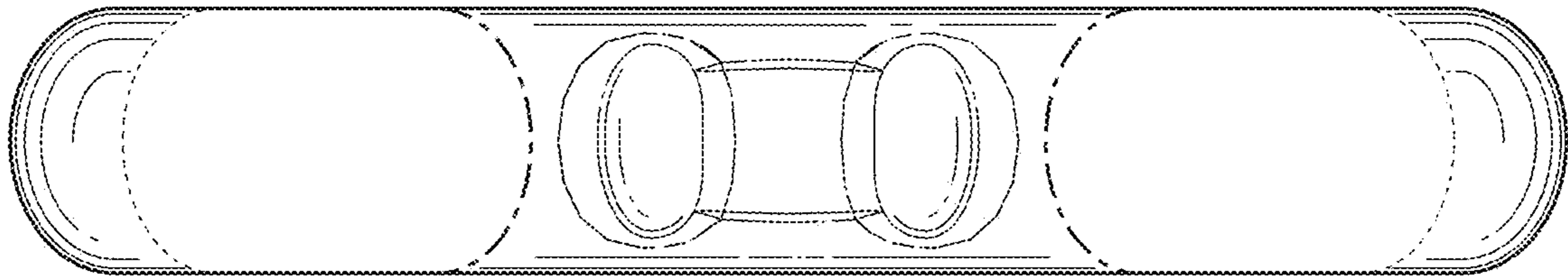

FIG. 35

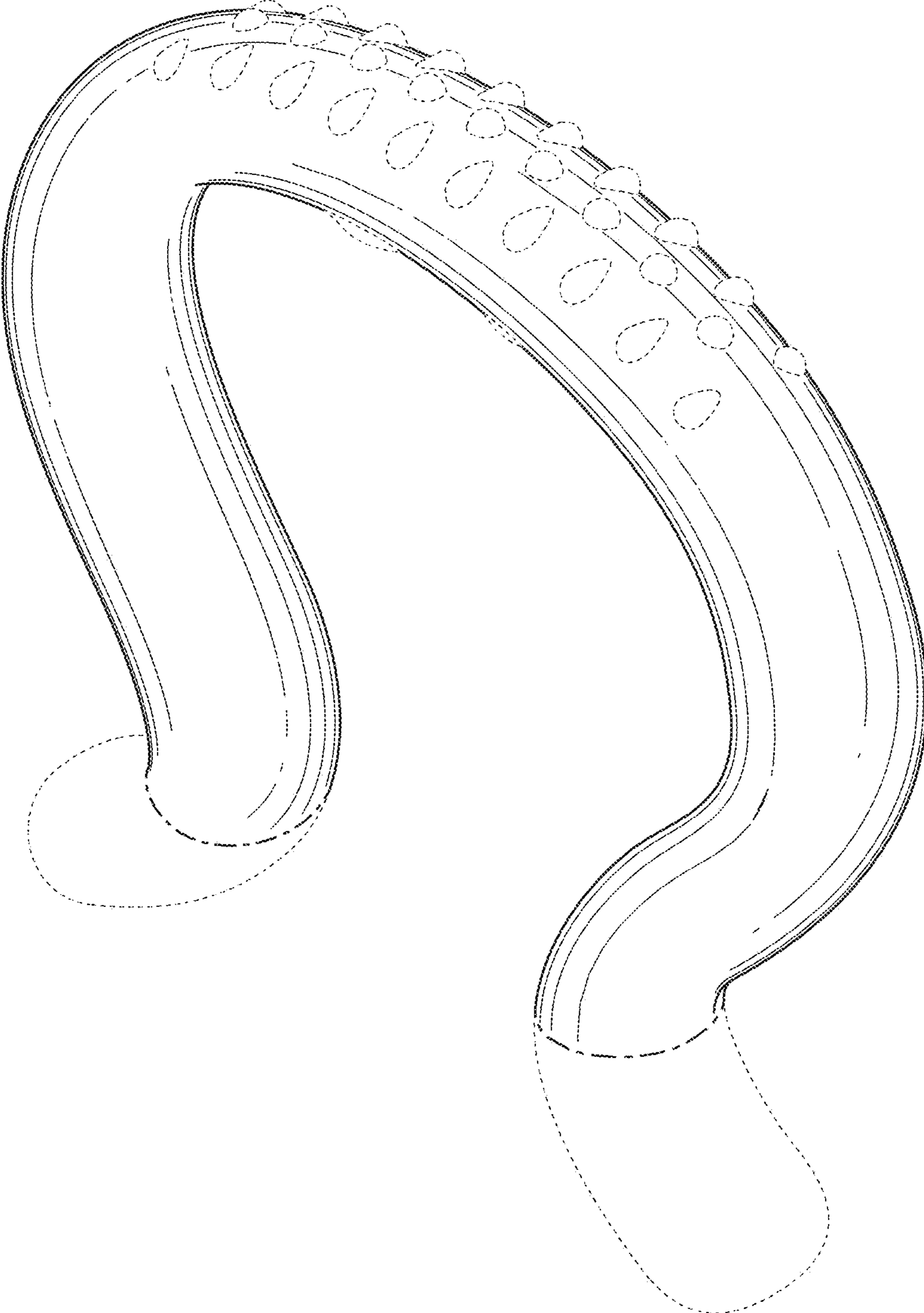

FIG. 36

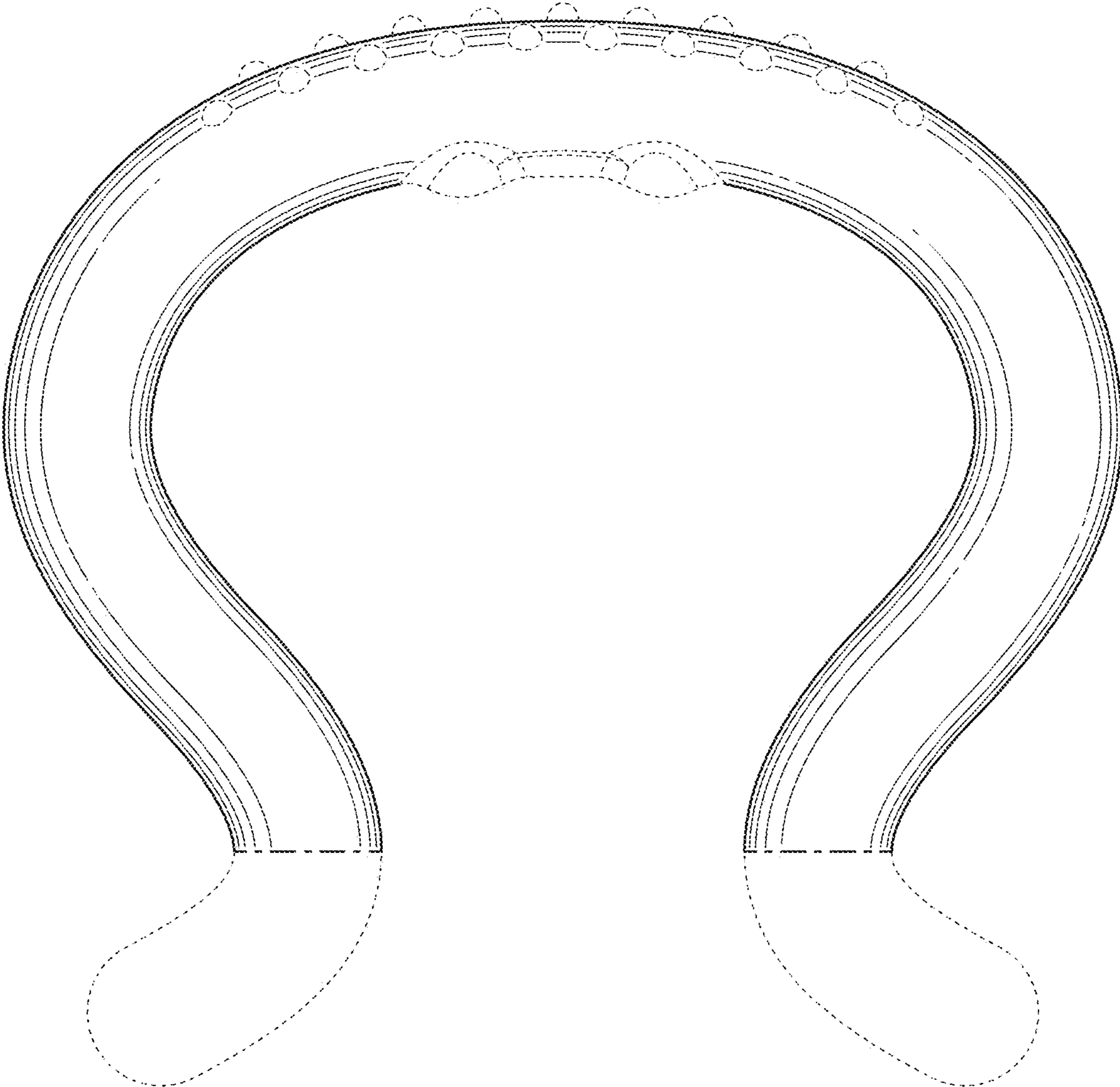

FIG. 37

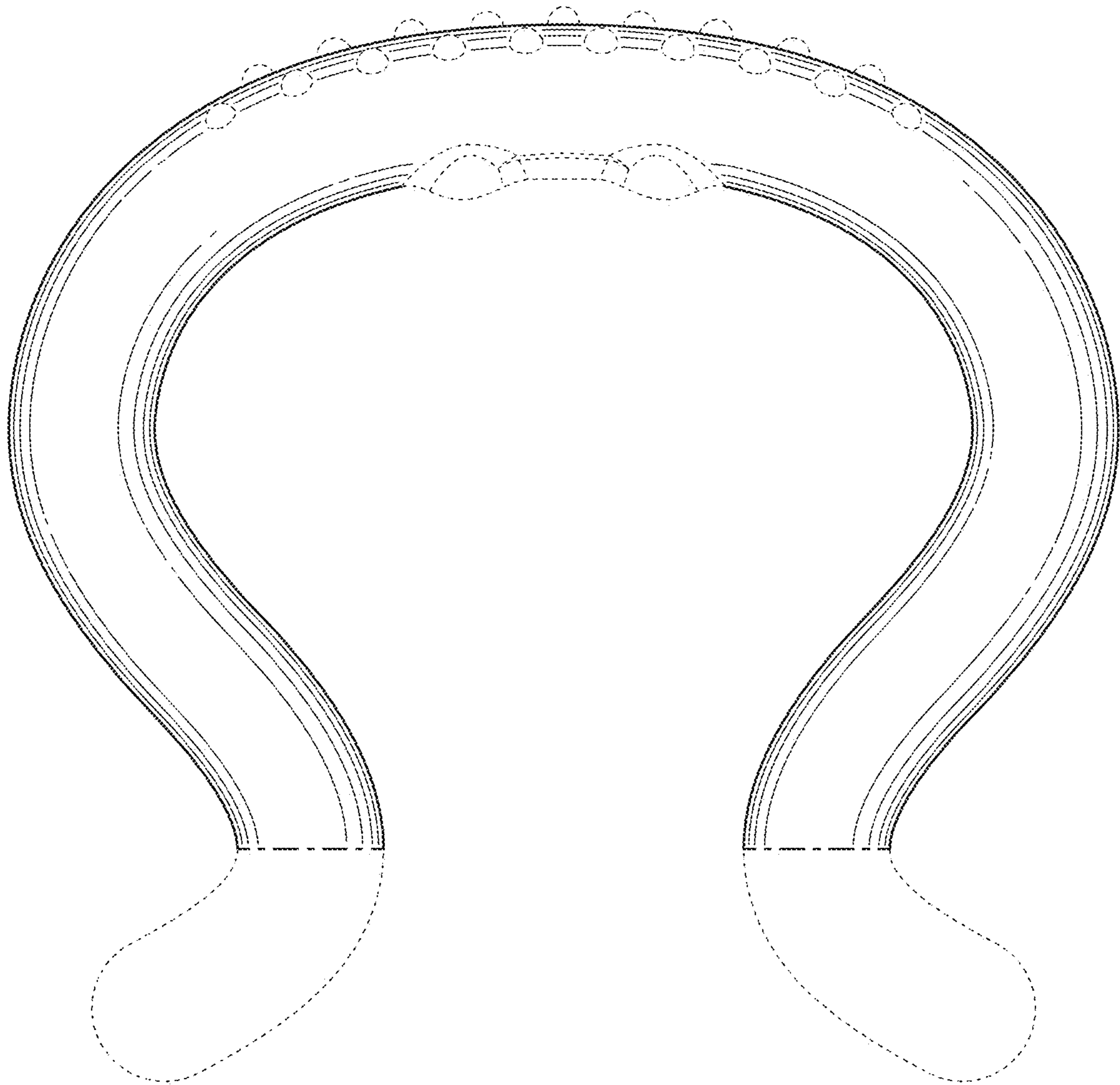

FIG. 38

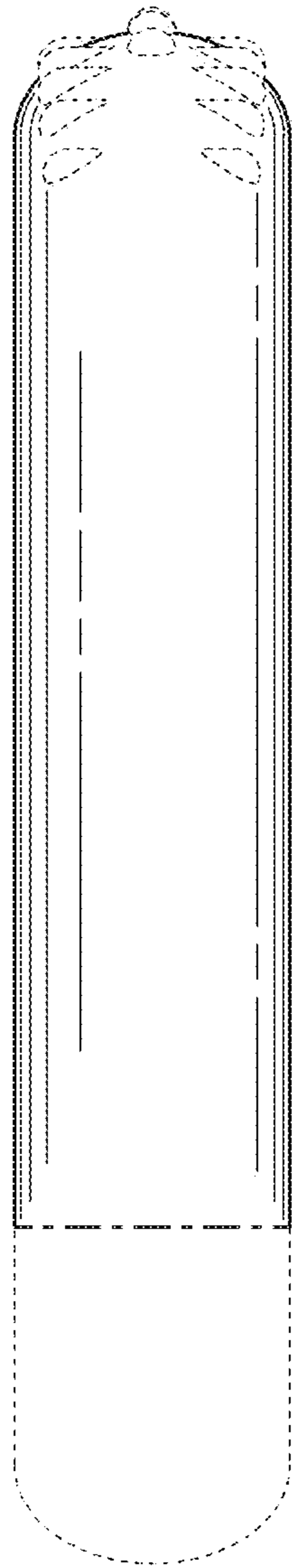

FIG. 39

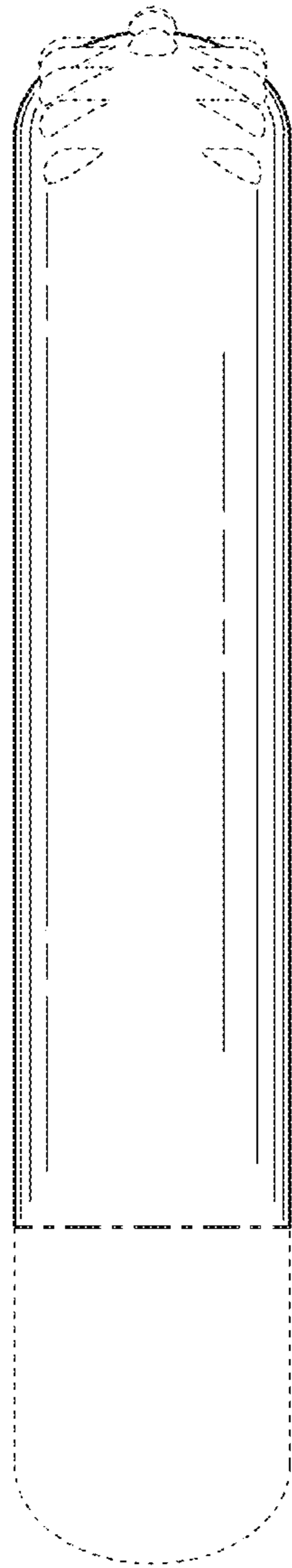

FIG. 40

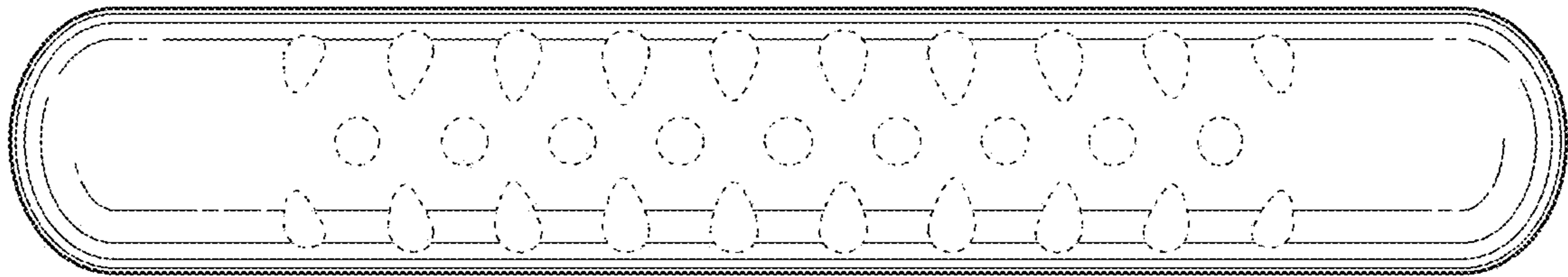

FIG. 41

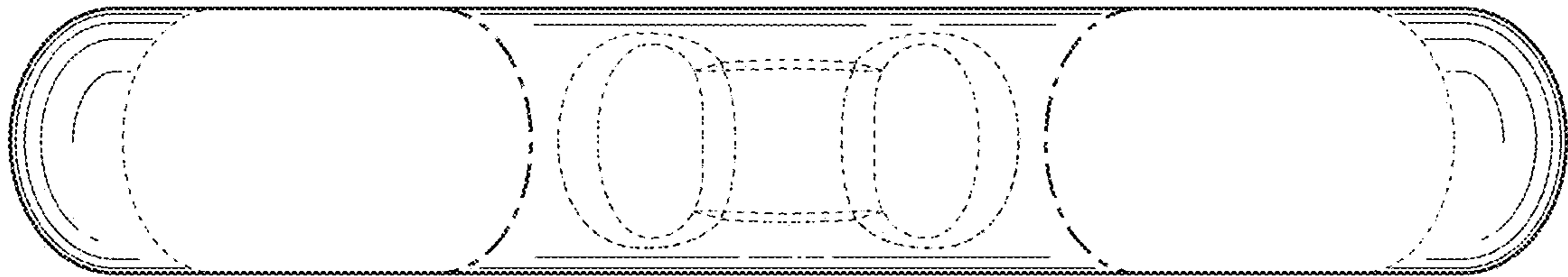

FIG. 42

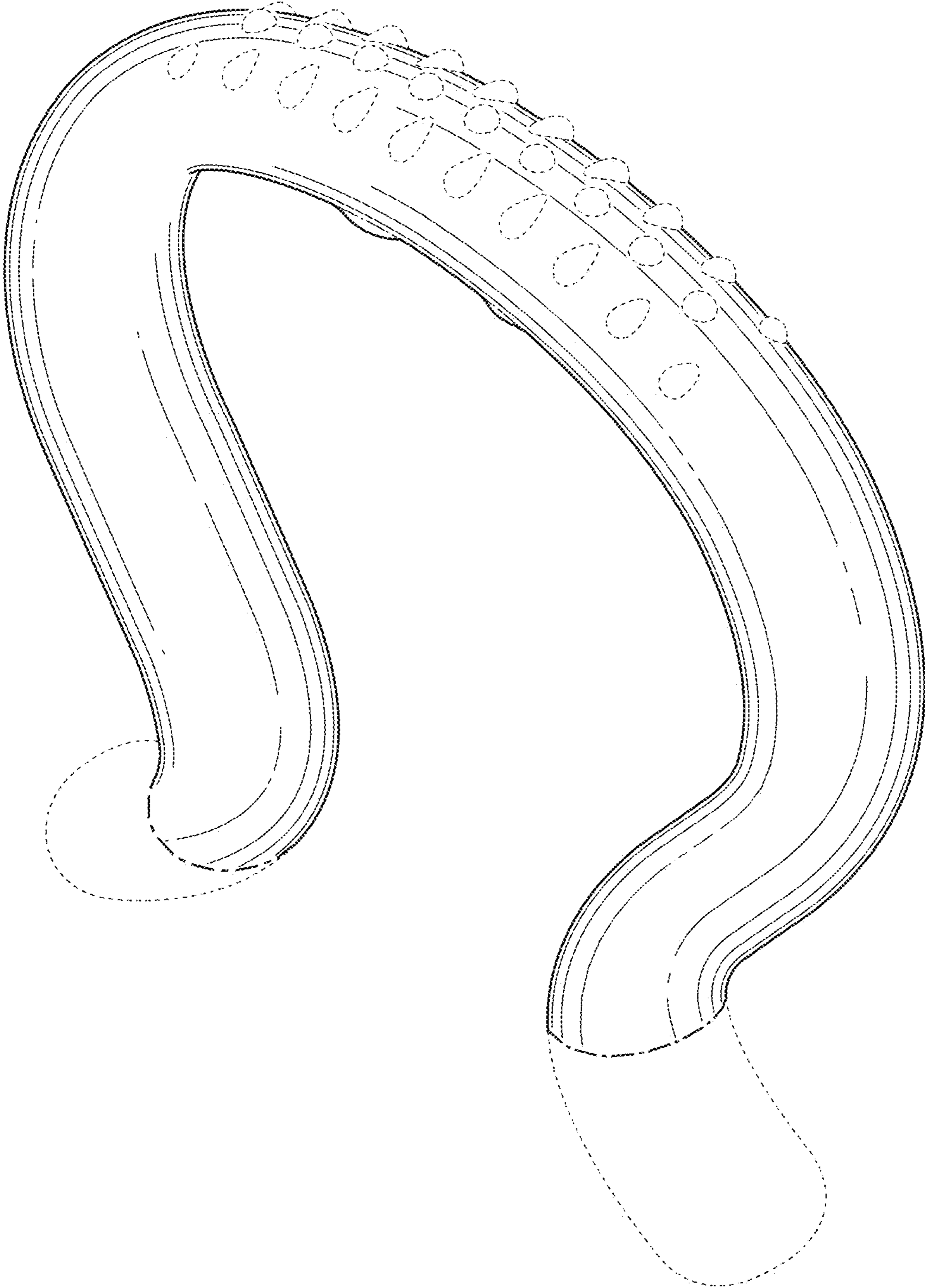

FIG. 43

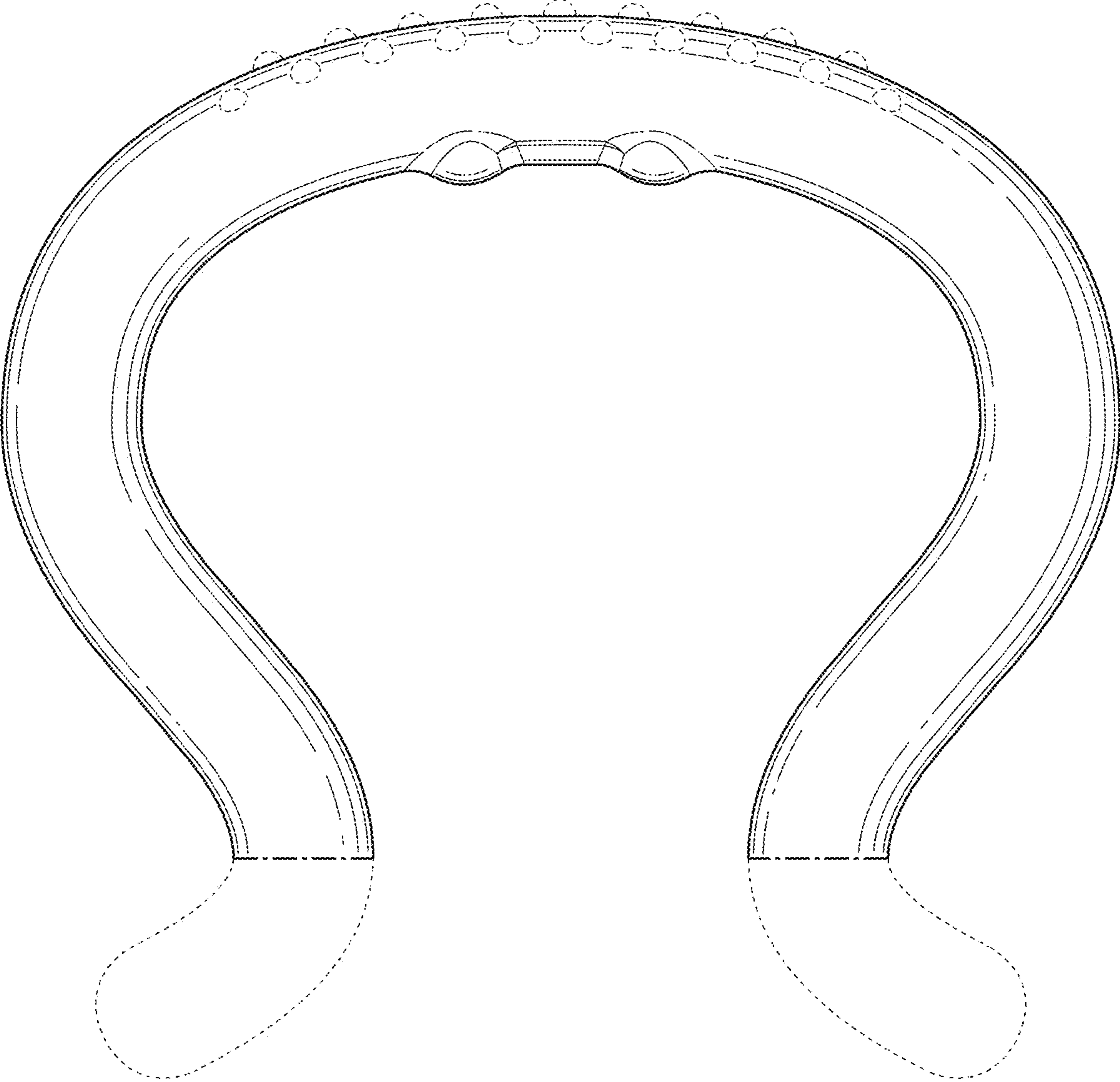

FIG. 44

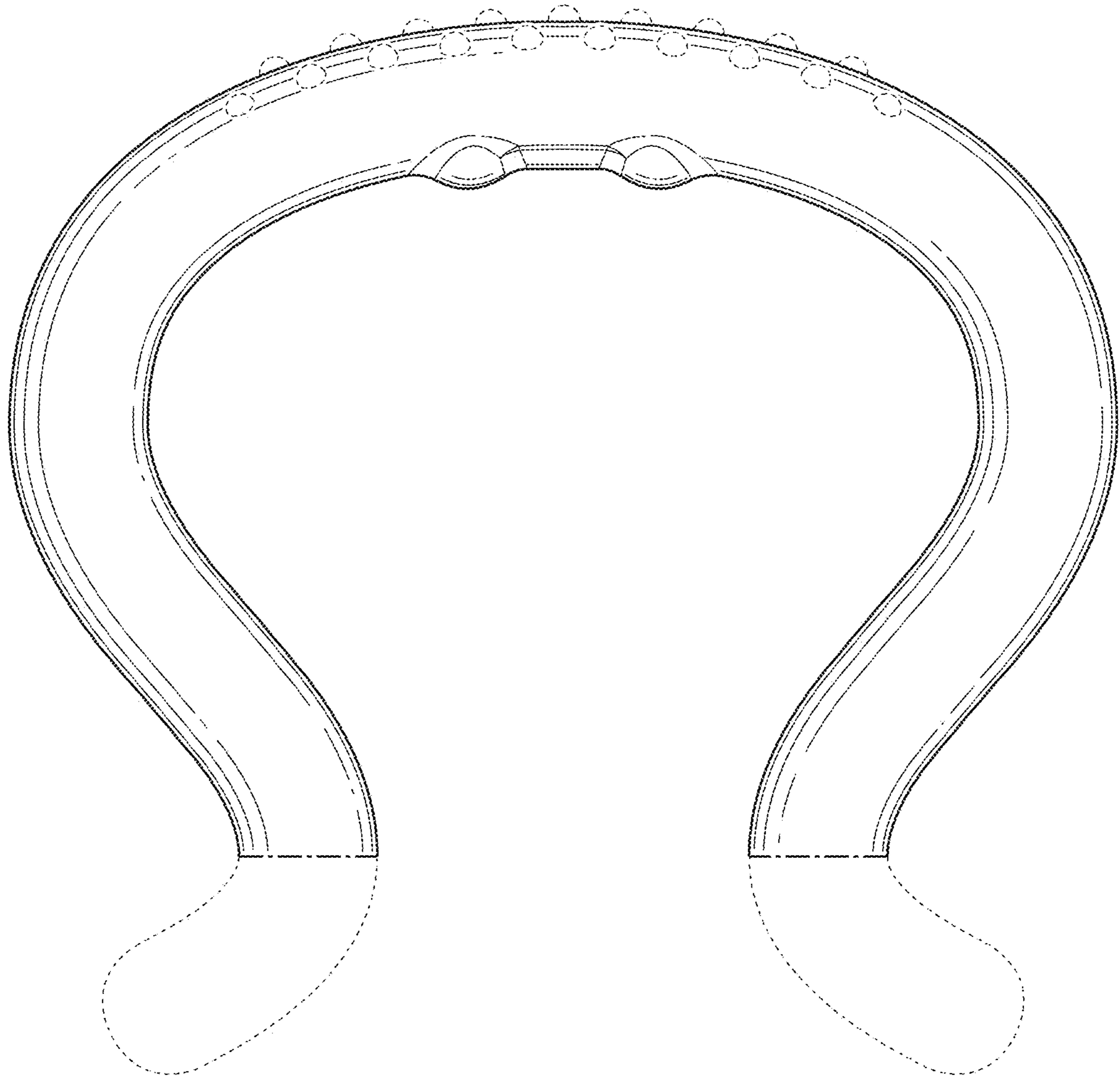

FIG. 45

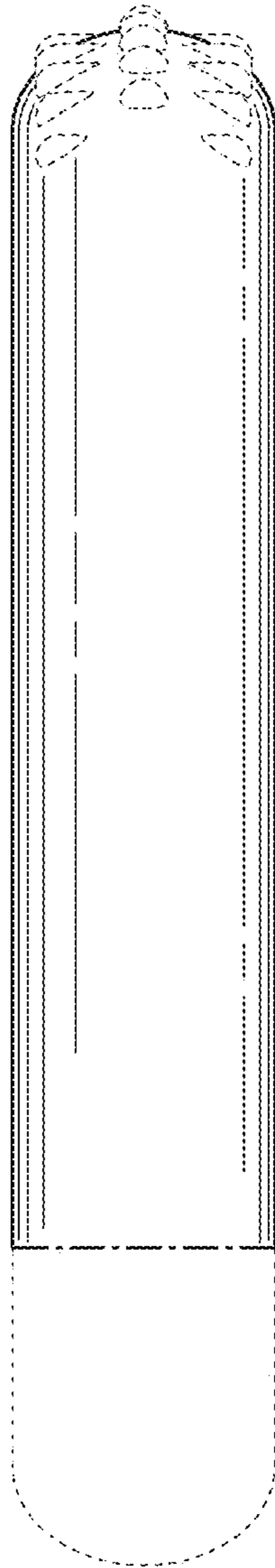

FIG. 46

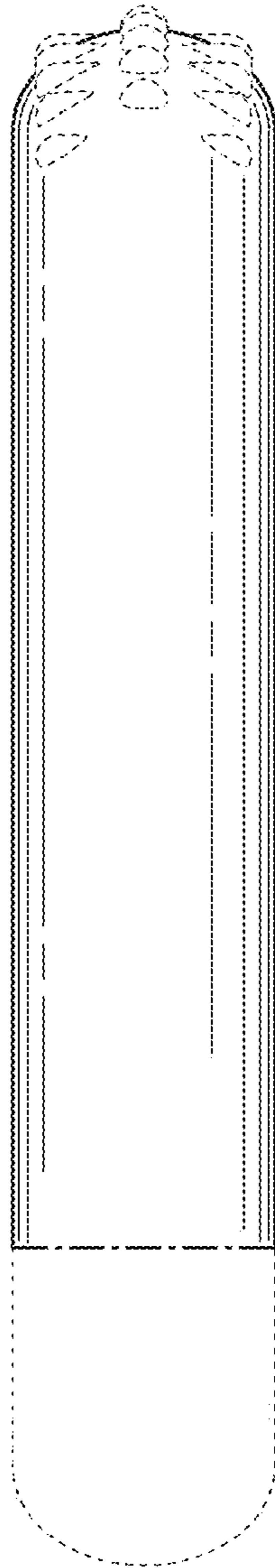

FIG. 47

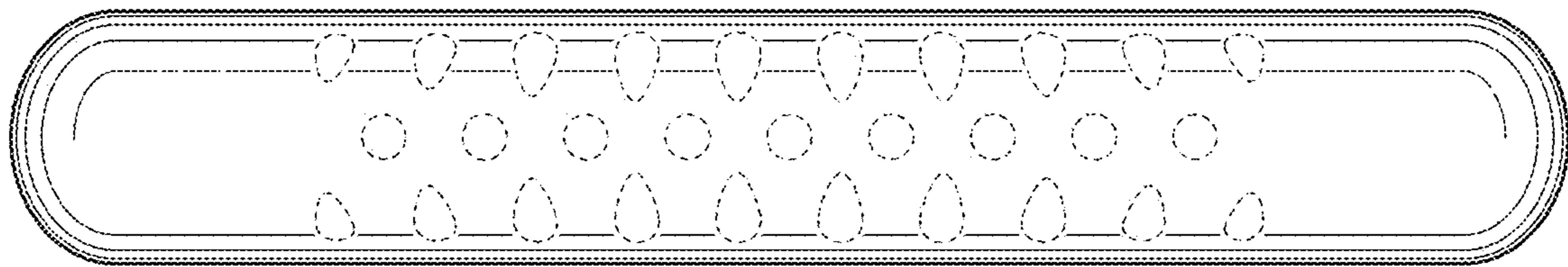

FIG. 48

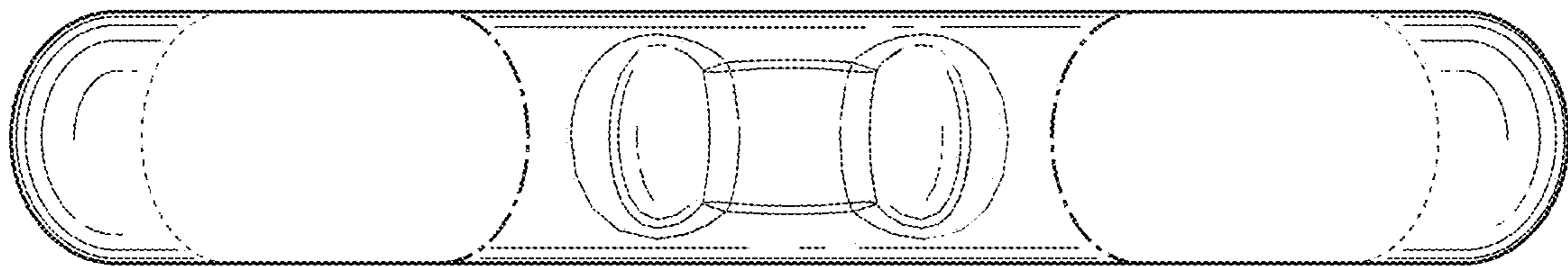

FIG. 49

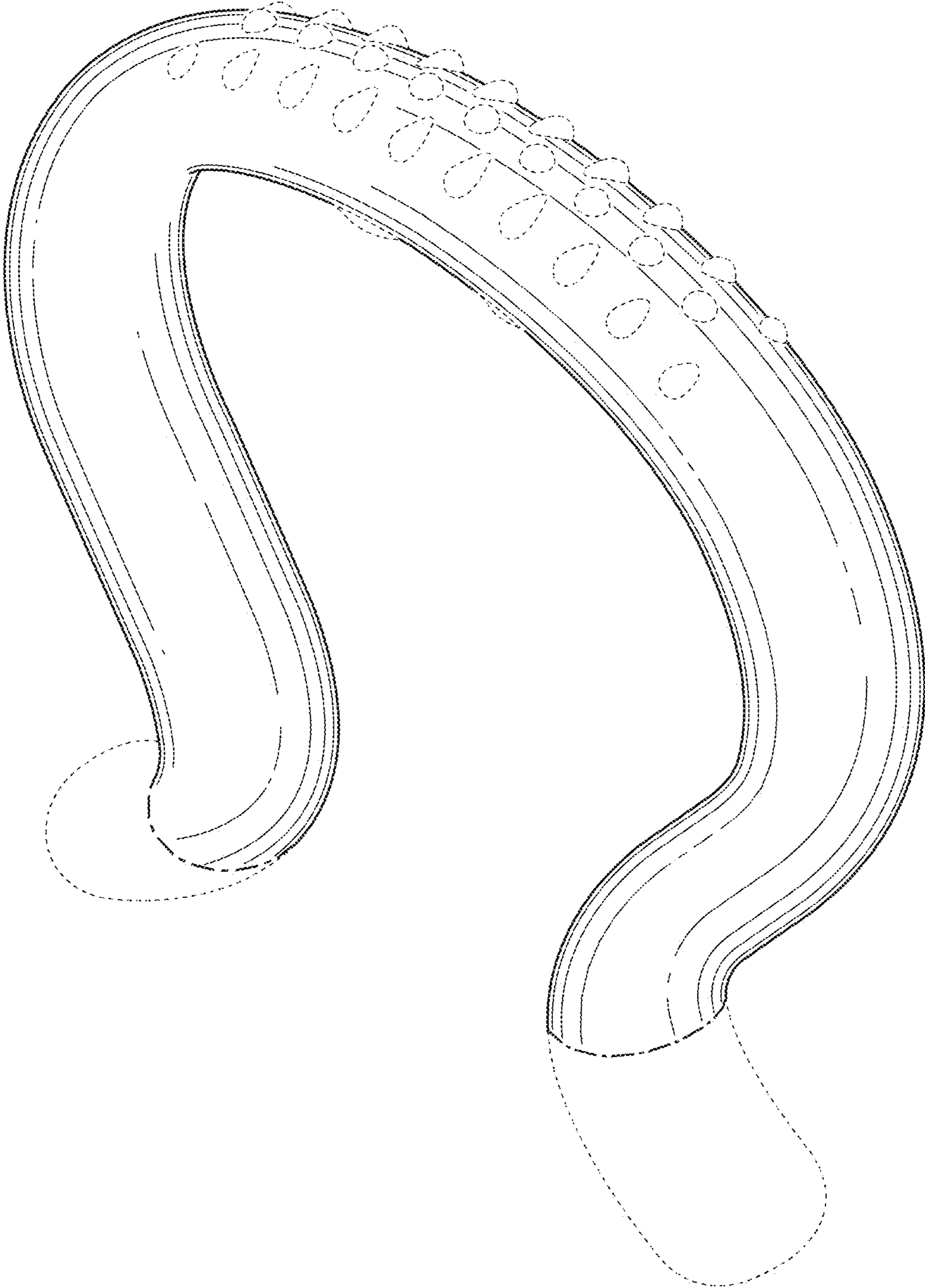

FIG. 50

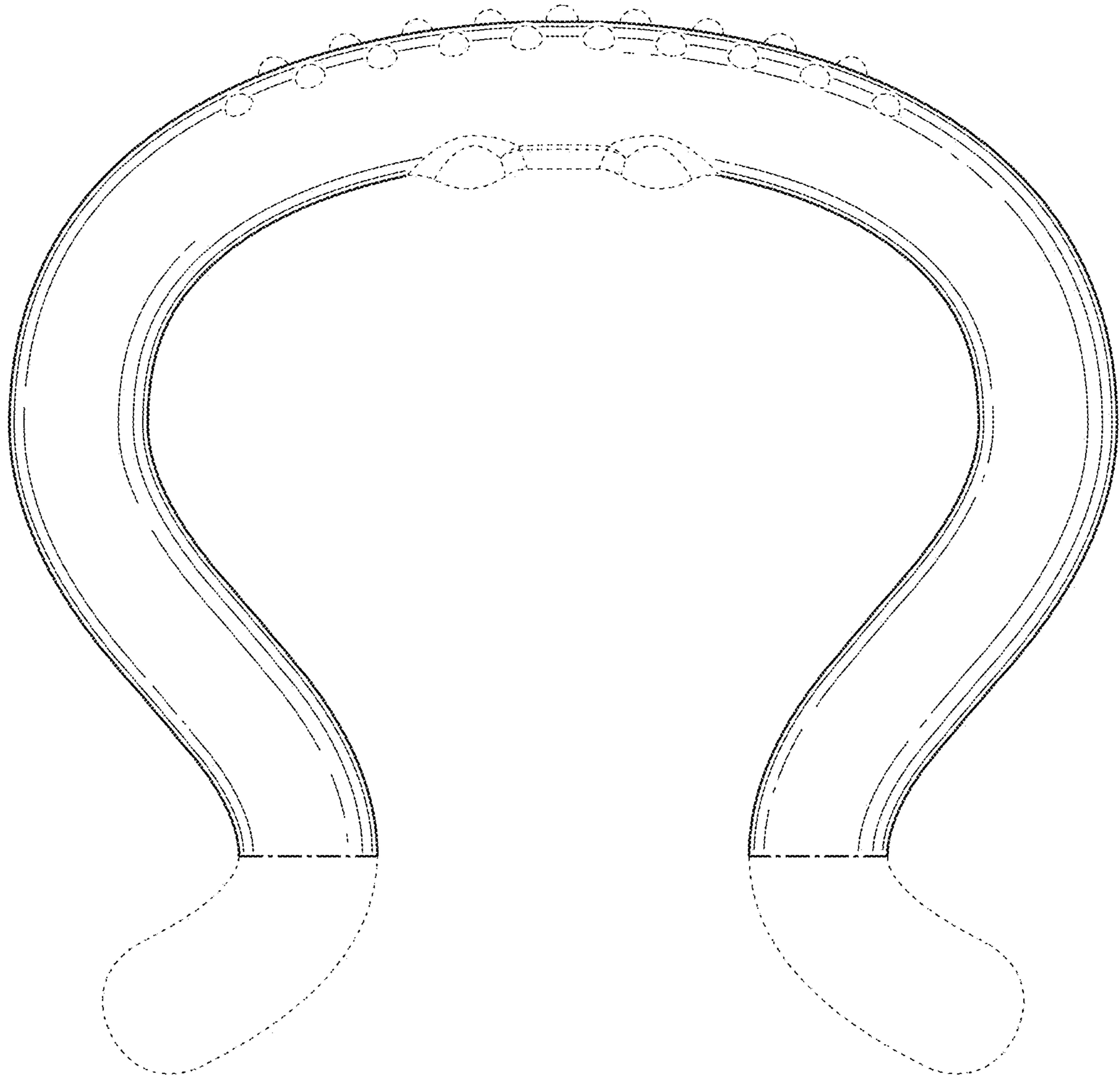

FIG. 51

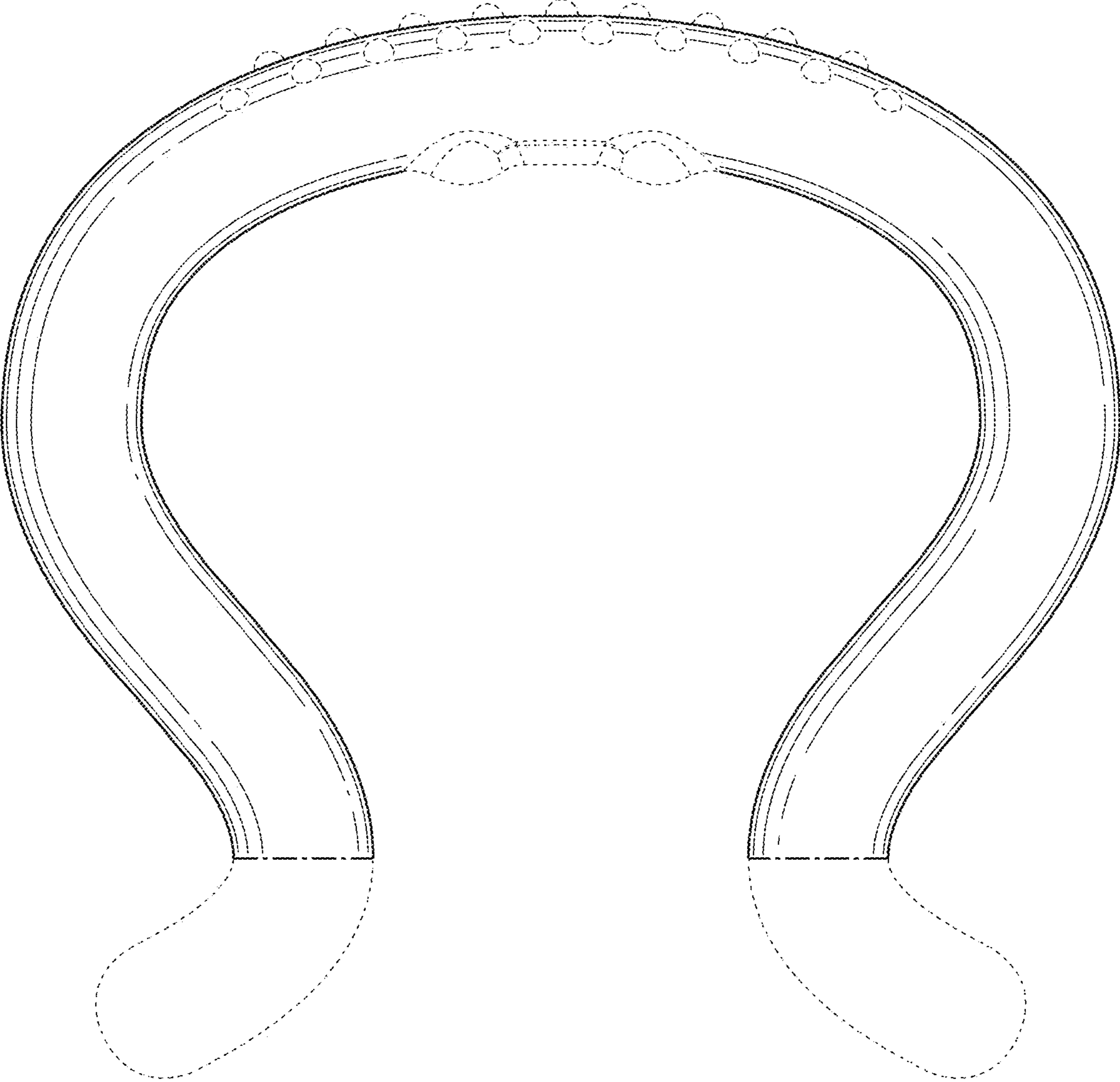

FIG. 52

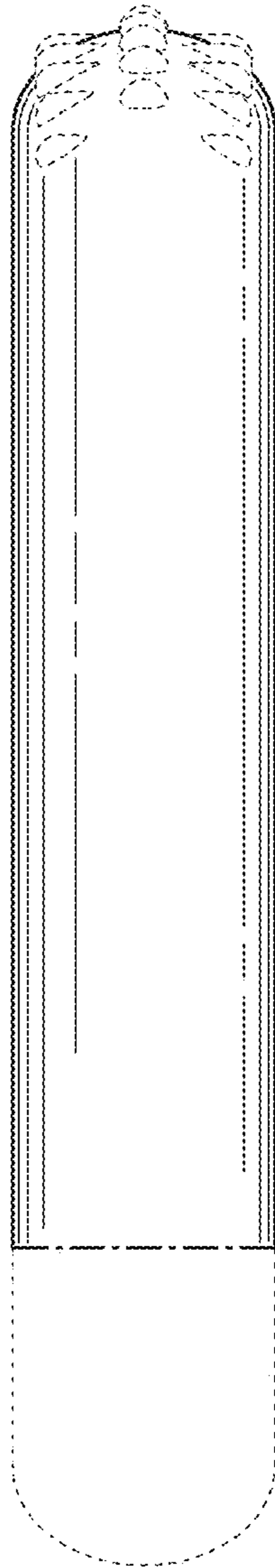

FIG. 53

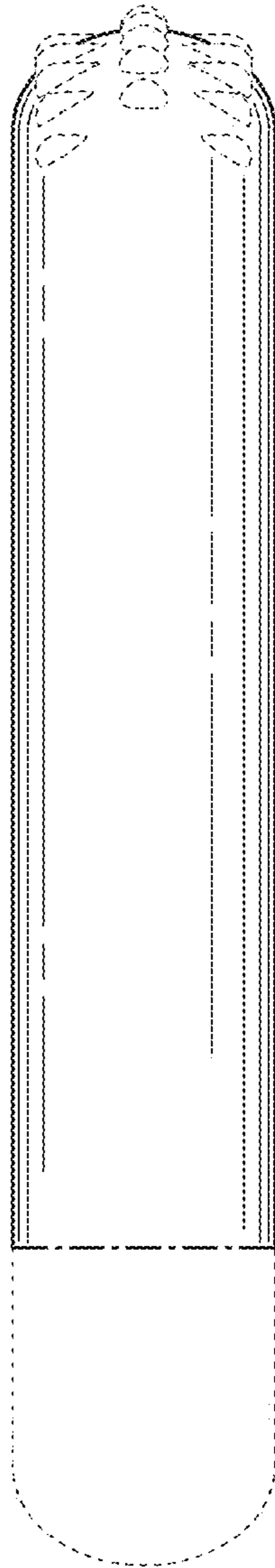

FIG. 54

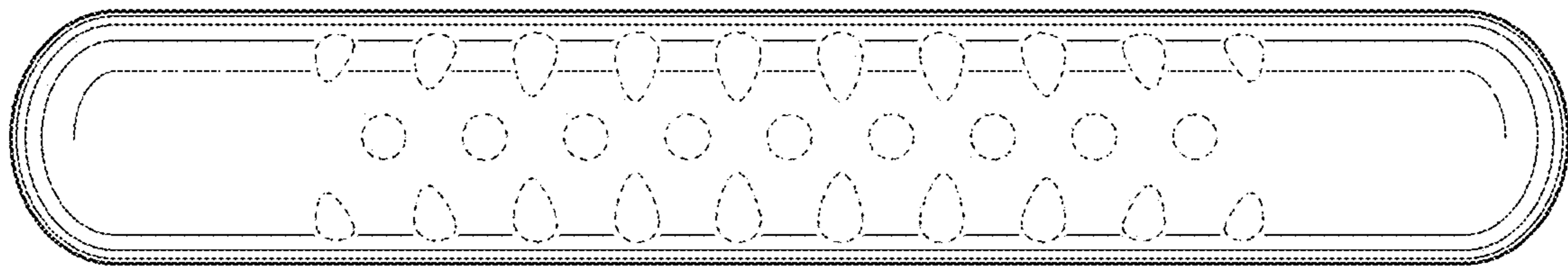

FIG. 55

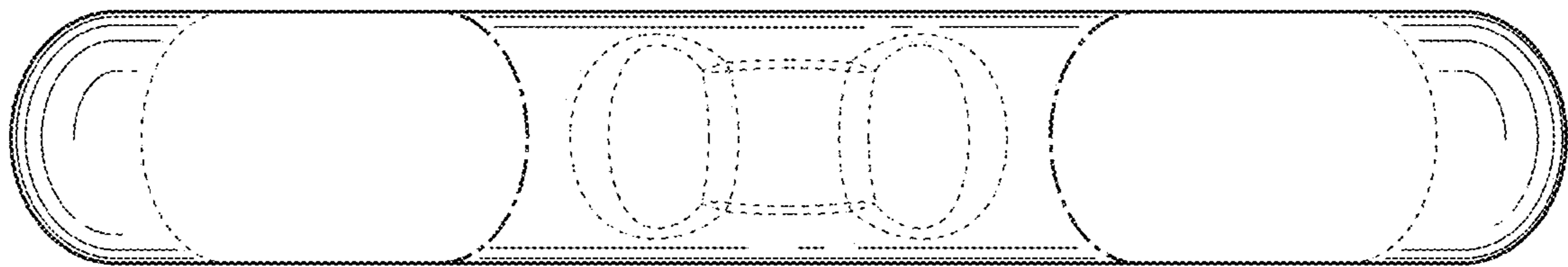

FIG. 56

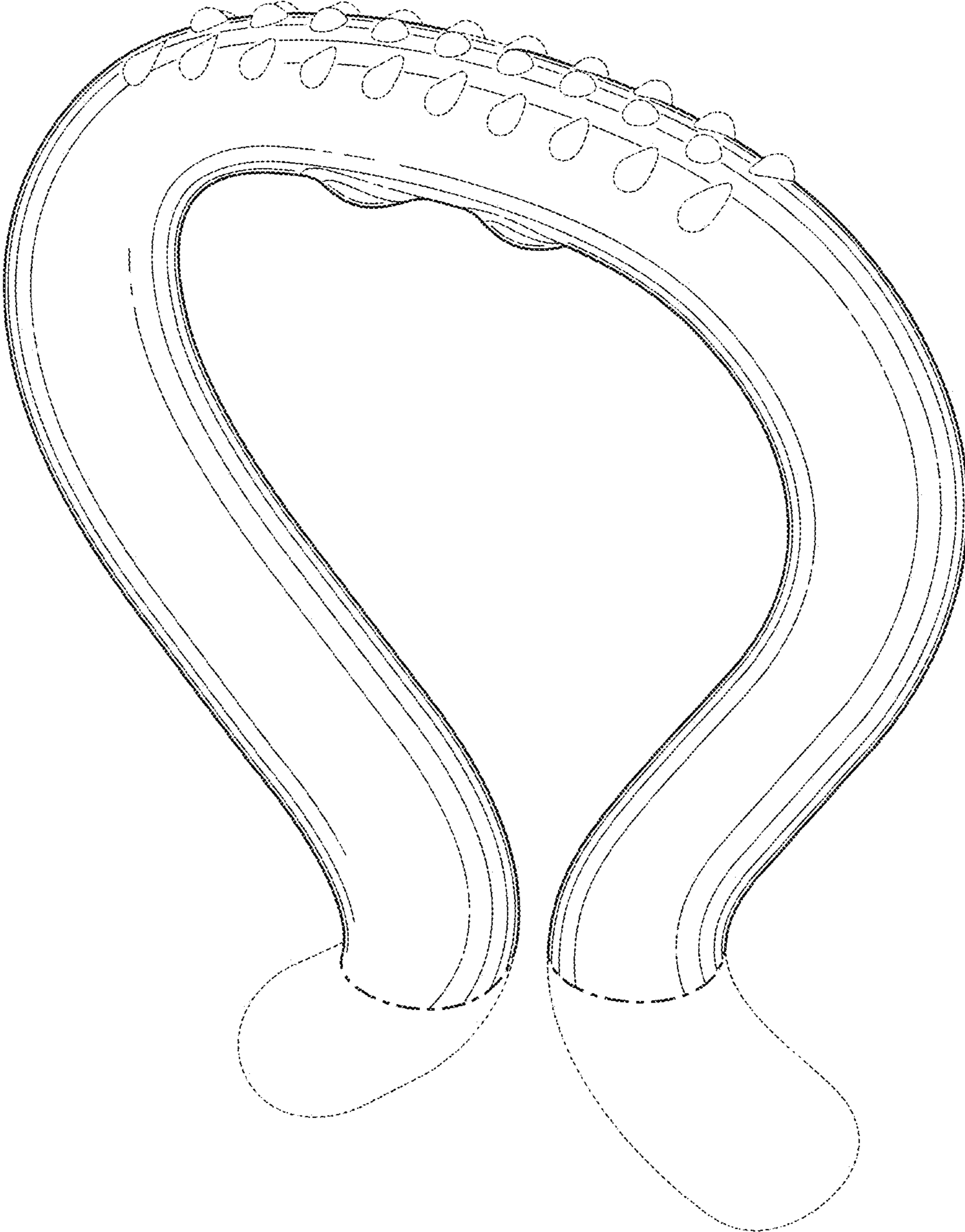

FIG. 57

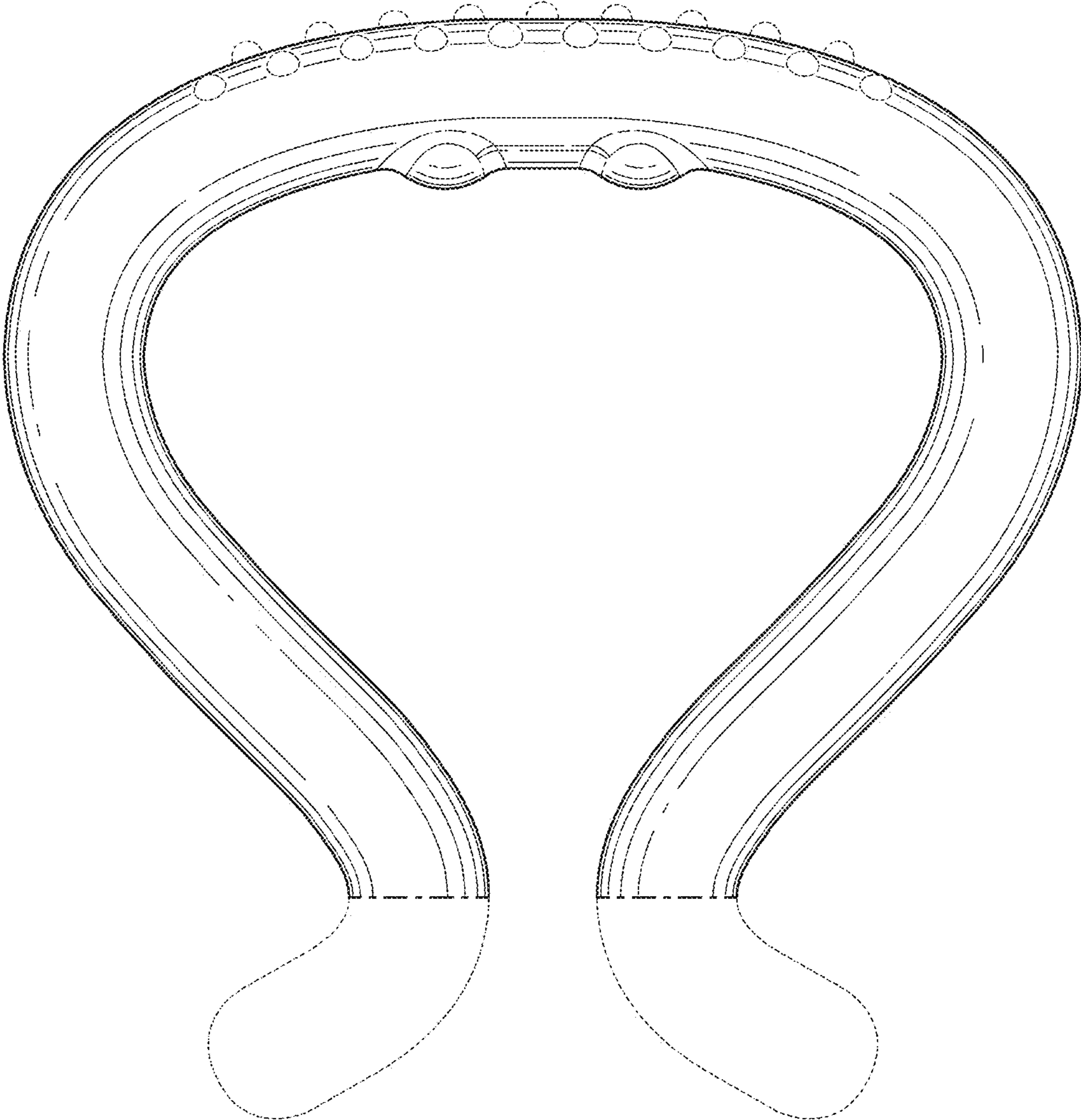

FIG. 58

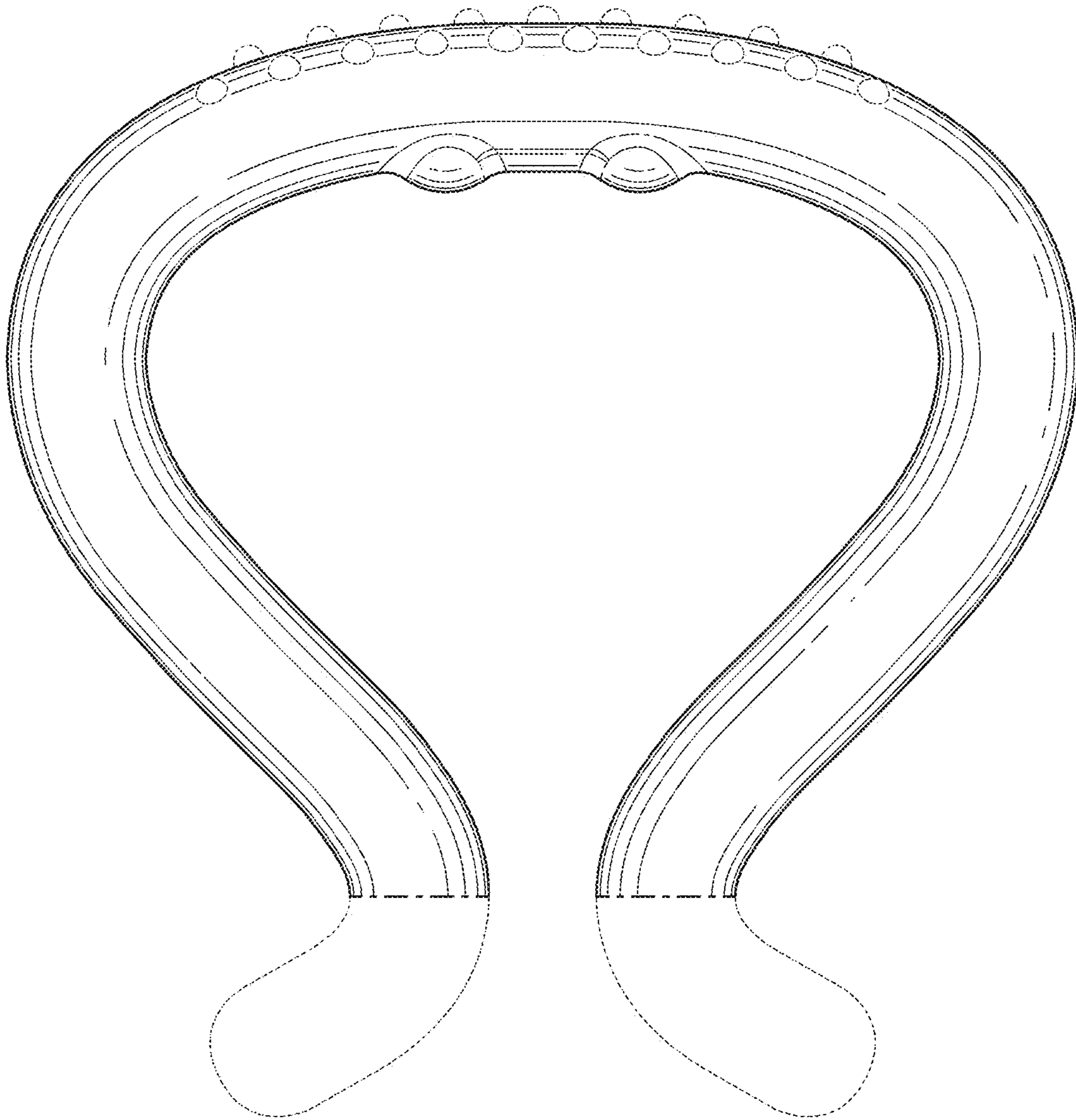

FIG. 59

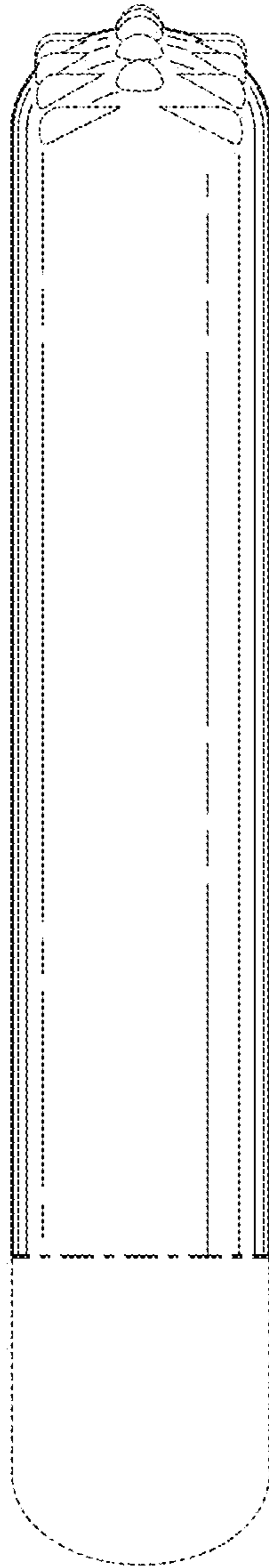

FIG. 60

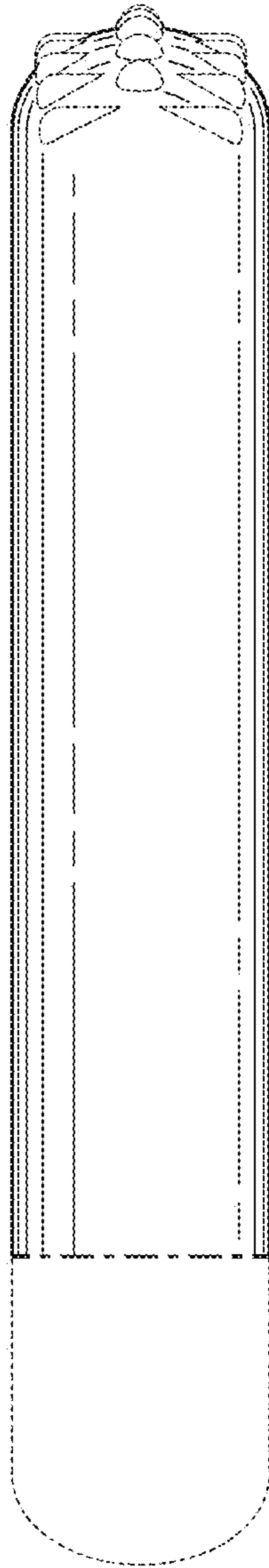

FIG. 61

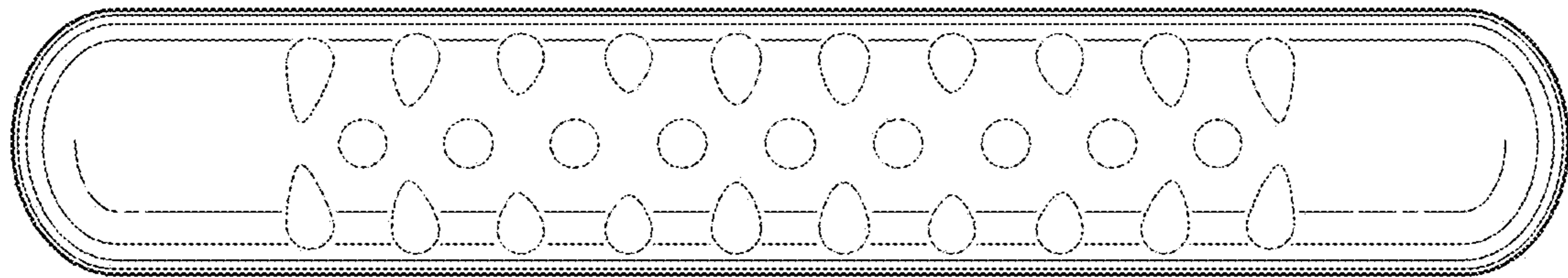

FIG. 62

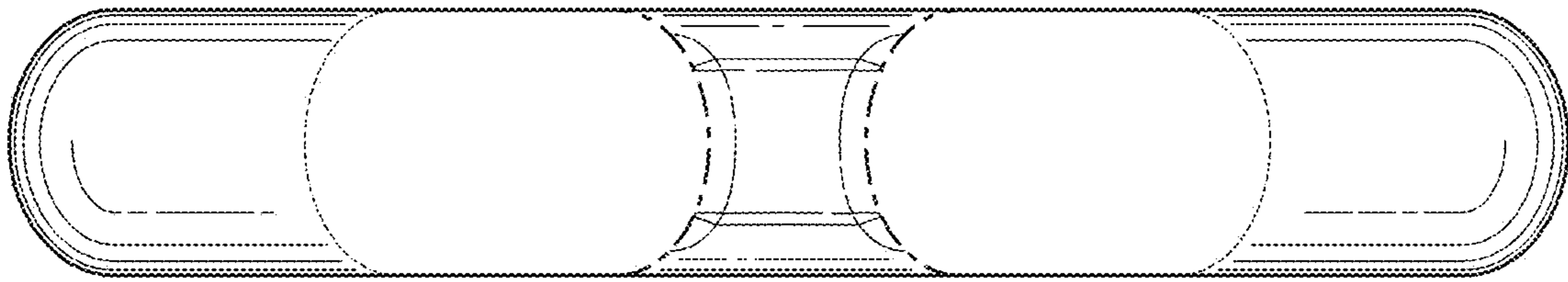

FIG. 63

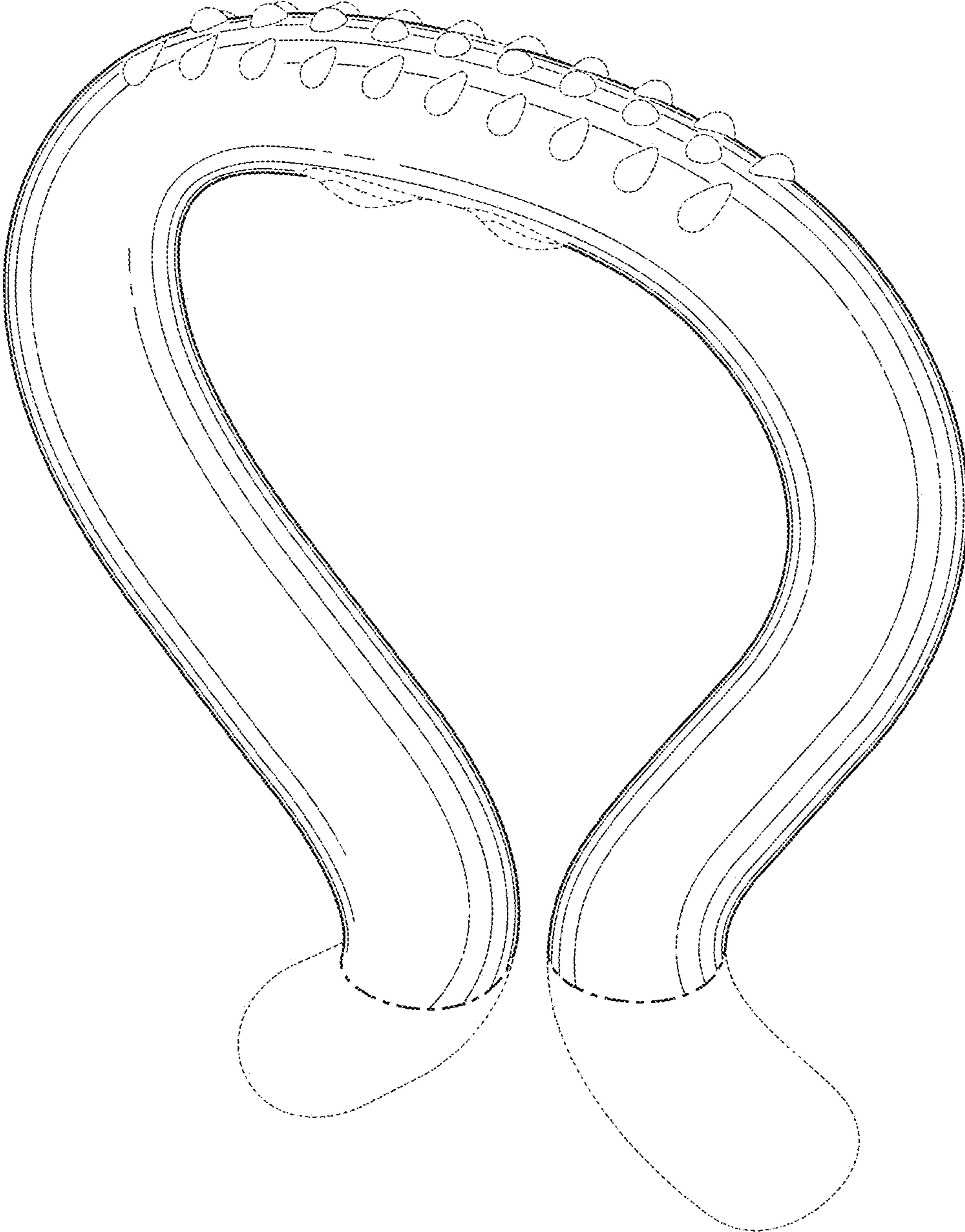

FIG. 64

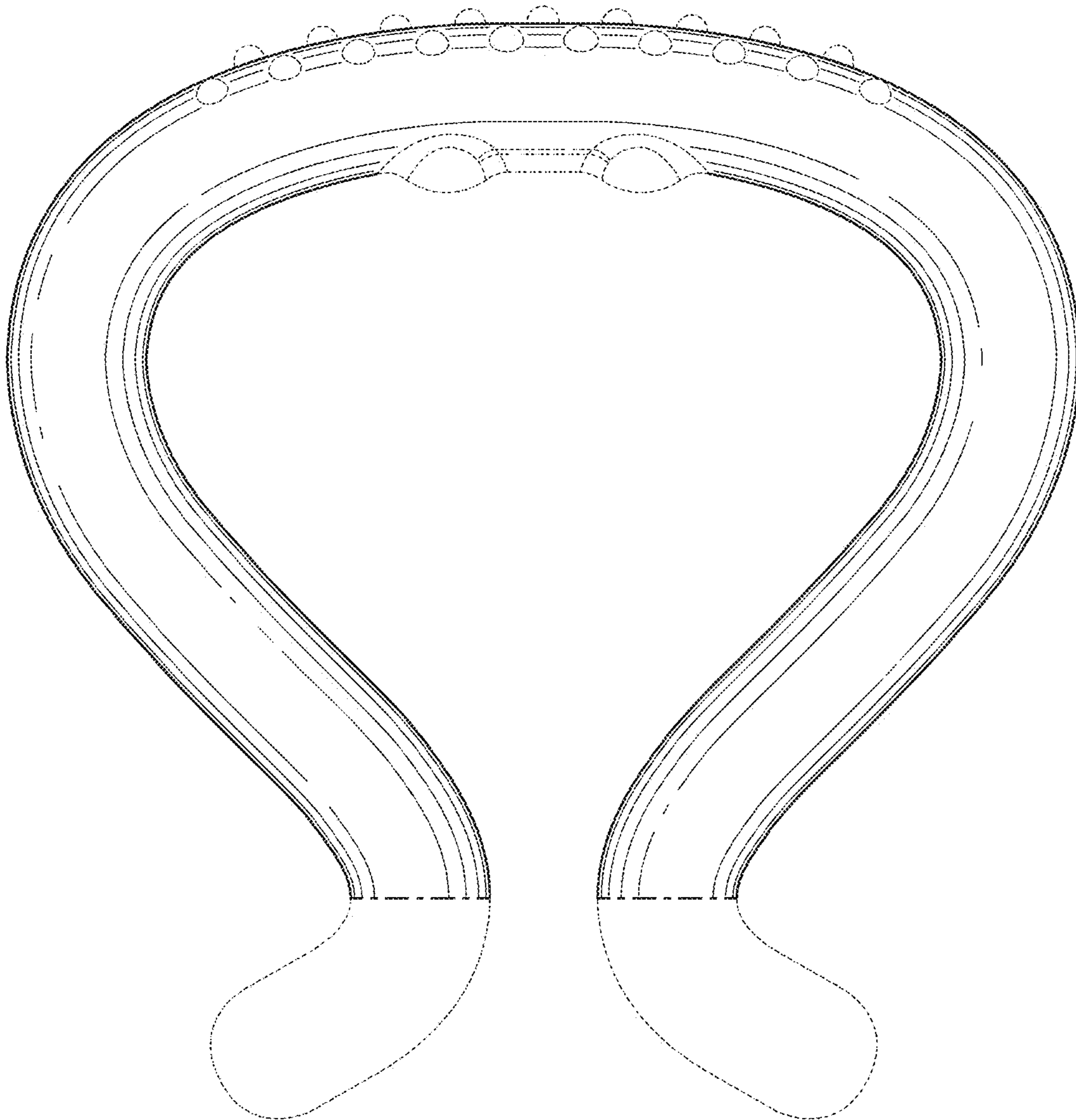

FIG. 65

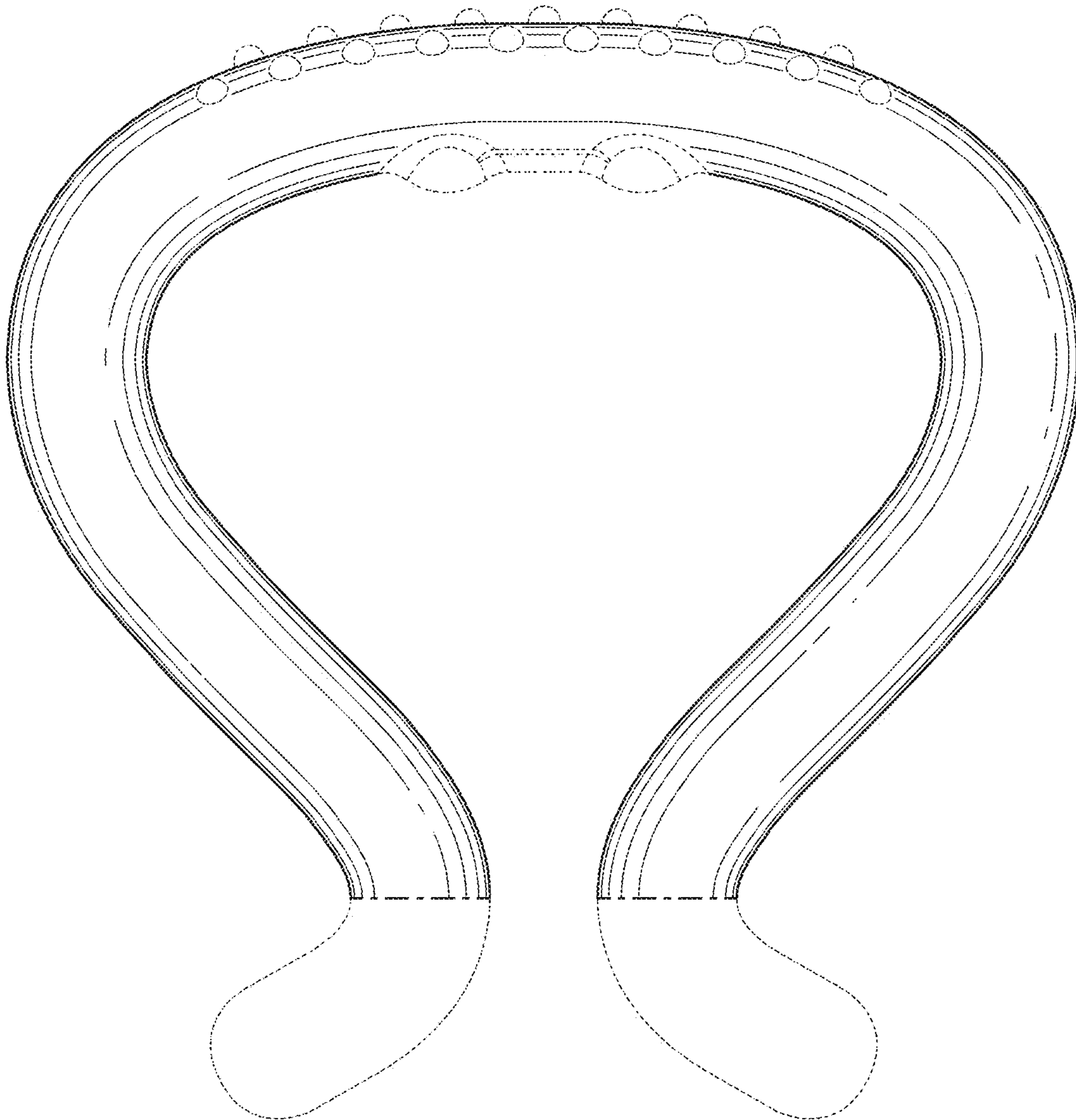

FIG. 66

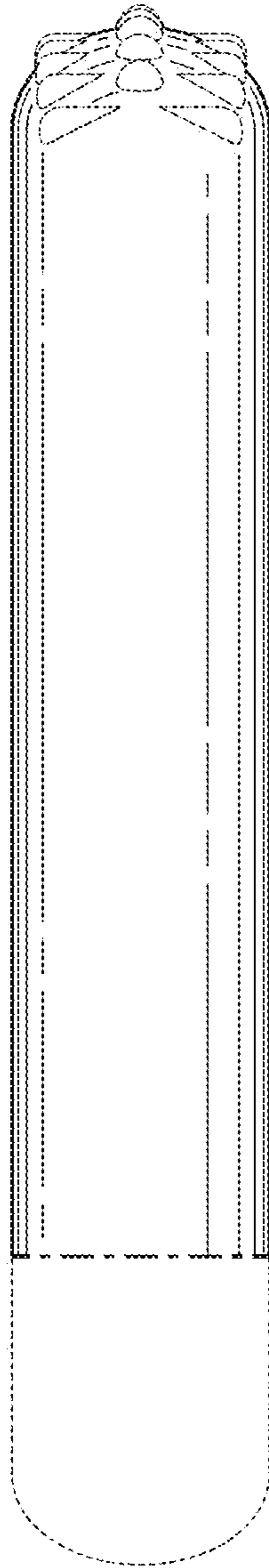

FIG. 67

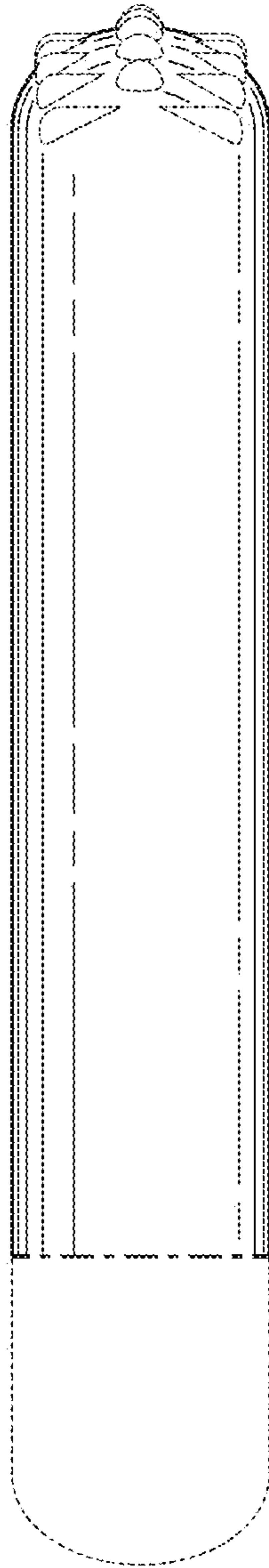

FIG. 68

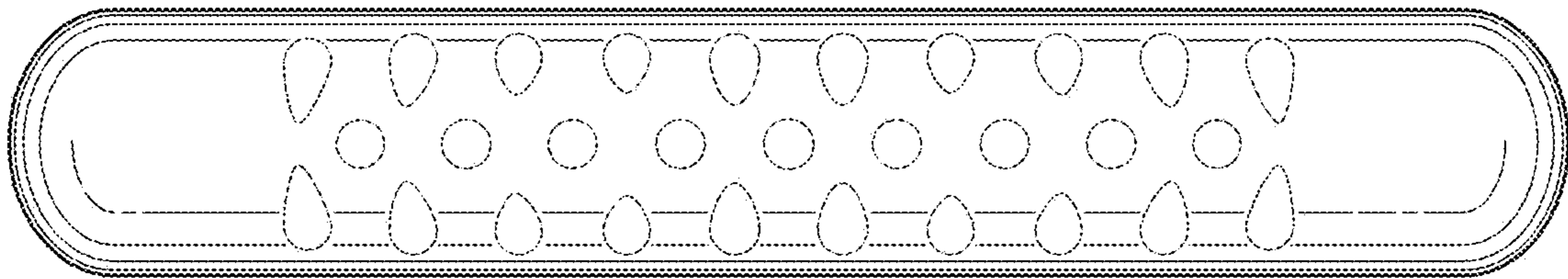

FIG. 69

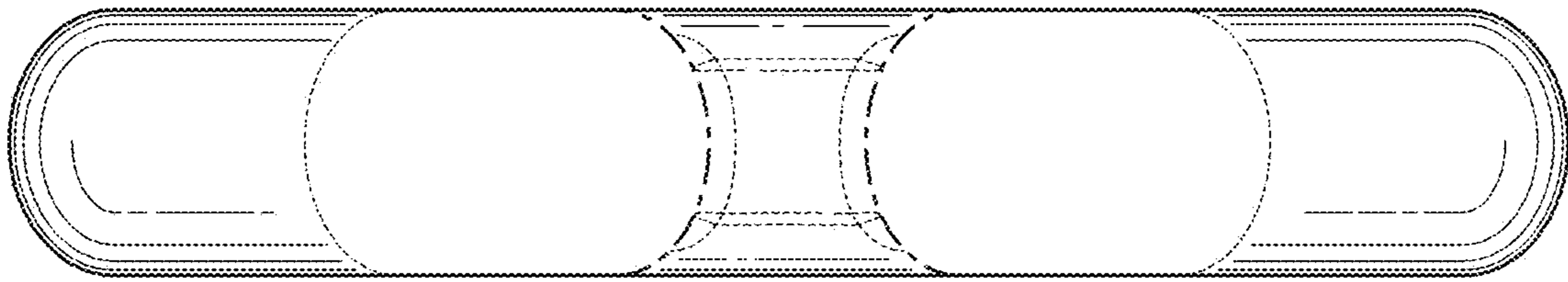

FIG. 70