



US00D983380S

(12) **United States Design Patent**
Lear et al.

(10) **Patent No.:** **US D983,380 S**

(45) **Date of Patent:** **** Apr. 11, 2023**

- (54) **WOUND CLOSURE DEVICE**
- (71) Applicants: **William Lear**, Corvallis, OR (US);
Daniel A Ladizinsky, Lake Oswego,
OR (US); **Jennifer Akeroyd**, Corvallis,
OR (US)
- (72) Inventors: **William Lear**, Corvallis, OR (US);
Daniel A Ladizinsky, Lake Oswego,
OR (US); **Jennifer Akeroyd**, Corvallis,
OR (US)
- (73) Assignee: **SUTUREGARD Medical Inc.**,
Corvallis, OR (US)

- D242,954 S * 1/1977 Rand D24/189
- D364,798 S * 12/1995 Bright D8/394
- D379,513 S * 5/1997 Ierulli D24/106
- 5,792,173 A * 8/1998 Breen A61B 17/135
606/1
- D461,007 S * 7/2002 Dunshee D24/189
- 6,652,559 B1 * 11/2003 Tetreault A61B 17/085
606/213
- D681,832 S * 5/2013 Samlaska D24/189
- D795,442 S * 8/2017 Arbesman D24/189
- D812,761 S * 3/2018 Heni D24/189
- D885,587 S * 5/2020 Park D24/189
- D936,846 S * 11/2021 Eaves, III D24/189
- D946,768 S * 3/2022 Kemper D24/189
- 2003/0220596 A1 * 11/2003 Dunshee A61L 15/58
602/42
- 2017/0065270 A1 * 3/2017 Lindh, Sr. A61B 17/0401
- 2019/0008516 A1 * 1/2019 Darling, IV A61B 17/085
- 2022/0167987 A1 * 6/2022 Locke A61B 17/083

(**) Term: **15 Years**

(21) Appl. No.: **29/722,088**

(22) Filed: **Jan. 27, 2020**

Related U.S. Application Data

(63) Continuation of application No. 16/576,907, filed on
Sep. 20, 2019, now Pat. No. 10,702,262.

(51) **LOC (14) Cl.** **24-02**

(52) **U.S. Cl.**
USPC **D24/189**

(58) **Field of Classification Search**
USPC D24/110, 112, 110.5, 108, 124, 125, 145,
D24/151, 180, 181, 187-190
See application file for complete search history.

(56) **References Cited**

U.S. PATENT DOCUMENTS

- 3,342,183 A * 9/1967 Edenbaum A61F 13/025
D24/189
- 3,547,120 A * 12/1970 Grossman A61F 13/0203
D24/189

* cited by examiner

Primary Examiner — Jennifer L Watkins

(74) *Attorney, Agent, or Firm* — Wei & Sleman LLP

(57) **CLAIM**

The ornamental design for the wound closure device, as
shown and described.

DESCRIPTION

FIG. 1 is a top plan view of a wound closure device showing
our new design;
FIG. 2 is a bottom view thereof;
FIG. 3 is a right side view thereof;
FIG. 4 is a left side view thereof;
FIG. 5 is a front view thereof;
FIG. 6 is a back view thereof; and,
FIG. 7 is a front perspective view thereof.

1 Claim, 1 Drawing Sheet

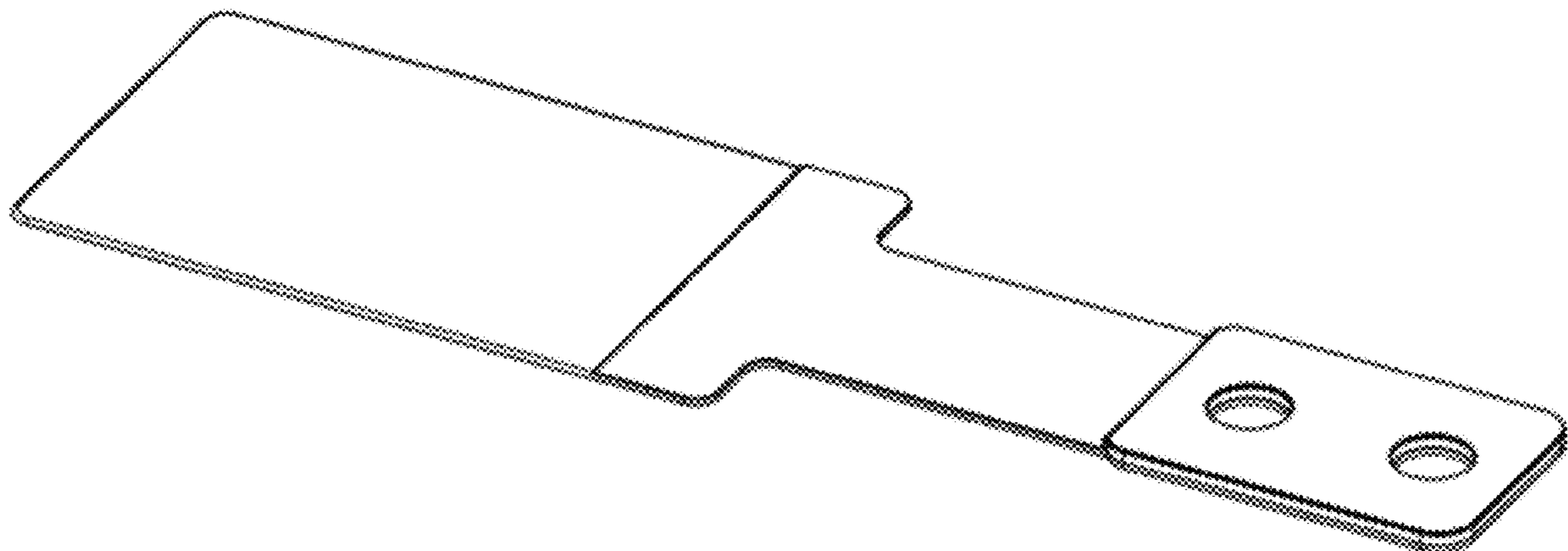

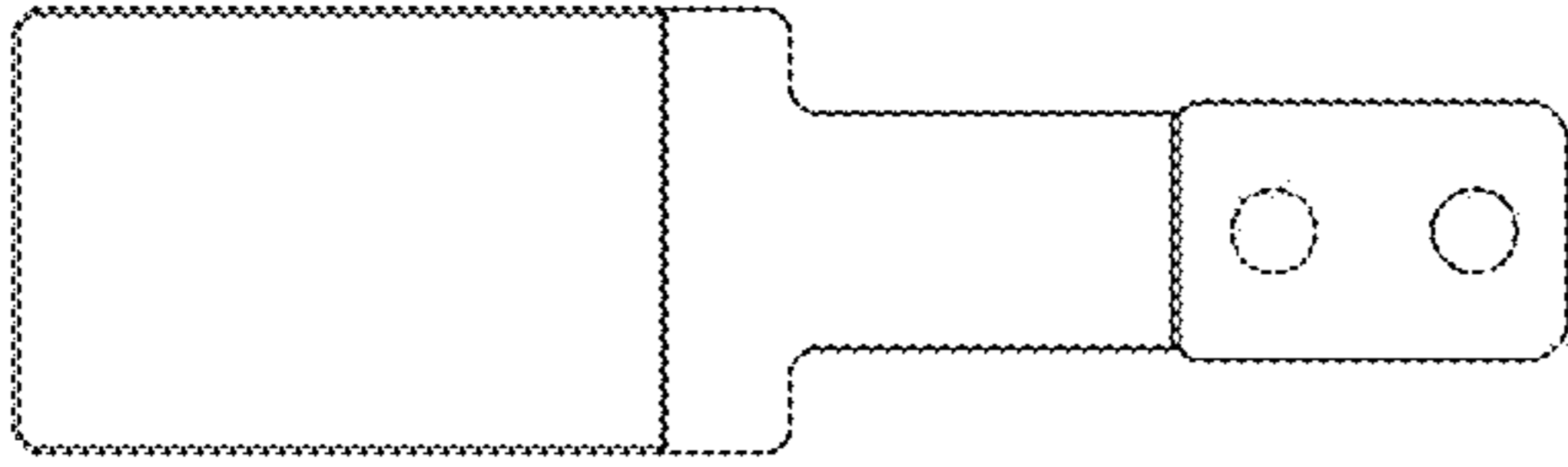

FIG. 1

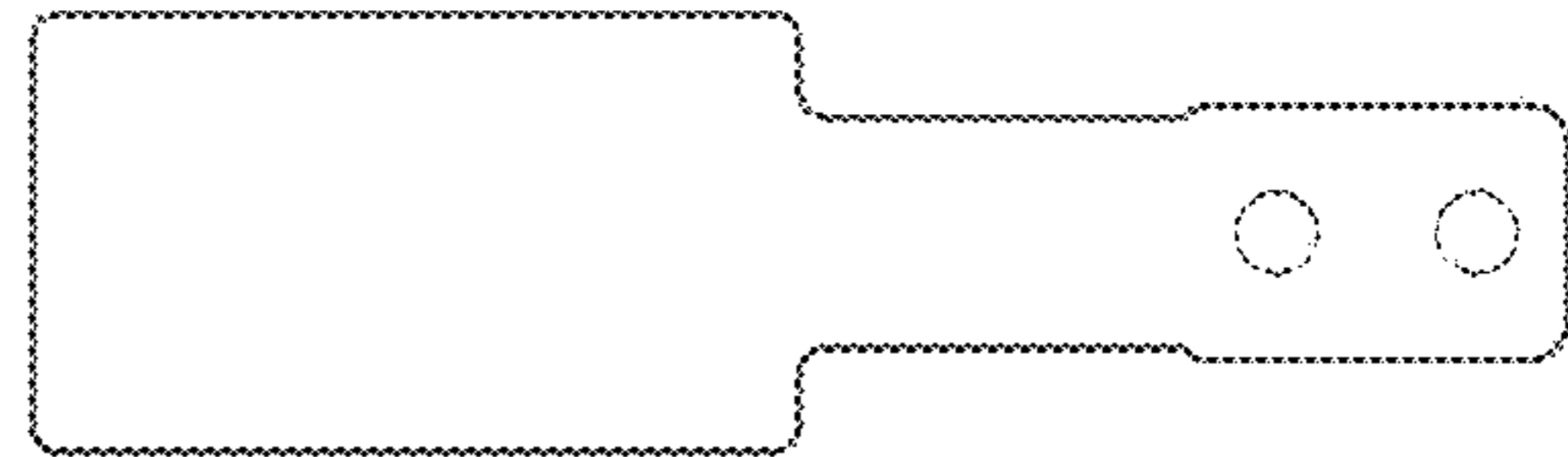

FIG. 2

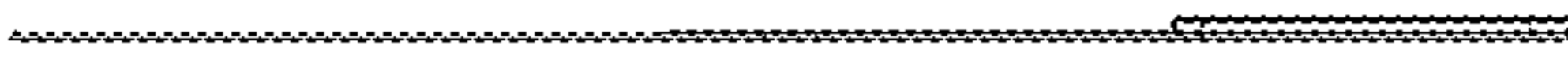

FIG. 3

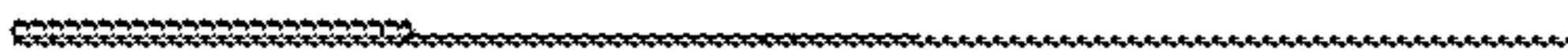

FIG. 4

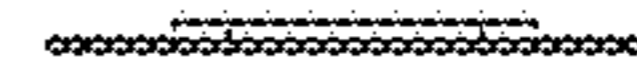

FIG. 5

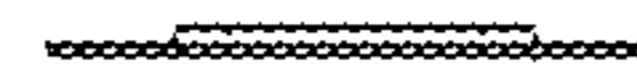

FIG. 6

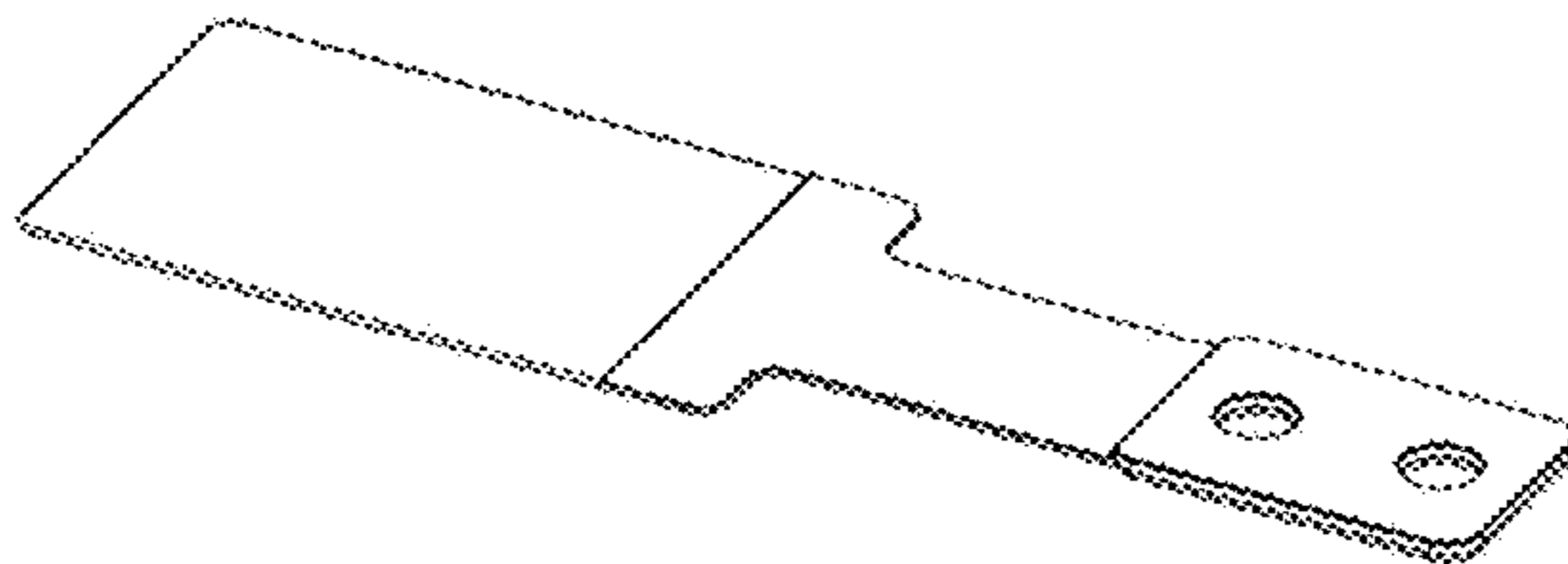

FIG. 7