



US00D983344S

(12) **United States Design Patent**
Lee

(10) **Patent No.:** **US D983,344 S**
(45) **Date of Patent:** **** Apr. 11, 2023**

(54) **AROMA DIFFUSER**
(71) Applicant: **BLOOMY LOTUS LIMITED**, Hong Kong (HK)
(72) Inventor: **Leander Lee**, New York, NY (US)
(73) Assignee: **BLOOMY LOTUS LIMITED**, Hong Kong (HK)

D917,686 S * 4/2021 Lee D23/366
D920,494 S * 5/2021 Shah D23/366
D922,558 S * 6/2021 Lee D23/366
D925,719 S * 7/2021 Lee D23/366
D926,305 S * 7/2021 Lee D23/366
D939,680 S * 12/2021 Luo D23/356
D941,448 S * 1/2022 Liu D23/356
2019/0134246 A1 5/2019 Sevy

(**) Term: **15 Years**
(21) Appl. No.: **29/782,926**
(22) Filed: **May 10, 2021**

FOREIGN PATENT DOCUMENTS

(30) **Foreign Application Priority Data**
Nov. 9, 2020 (CN) 202030673365.7
Nov. 9, 2020 (HK) 2017048.4
Feb. 10, 2021 (CN) 202130096124.5
Feb. 10, 2021 (CN) 202130096125.X
Feb. 10, 2021 (CN) 202130096128.3
Feb. 10, 2021 (CN) 202130096129.8
Feb. 10, 2021 (CN) 202130096161.6

CN 302484632 S 6/2013
CN 303424713 S 10/2015
CN 303481392 S 12/2015
CN 303971001 S 12/2016
CN 304381350 S 3/2017
CN 304206652 S 7/2017
CN 304210586 S 7/2017
CN 304328656 S 10/2017
CN 304345815 S 11/2017
CN 304376278 11/2017
CN 304395248 S 12/2017
CN 304584734 S 4/2018
CN 304706632 S 6/2018
CN 305088238 S 9/2018
CN 304843192 S 10/2018
CN 304858973 S 10/2018
CN 304894666 S 11/2018
CN 304913934 S 11/2018
CN 304947186 S 12/2018
CN 305015114 S 1/2019
CN 305403367 S 10/2019
CN 305511288 S 12/2019
CN 305614169 S 2/2020
CN 305782380 S 5/2020
CN 305795945 S 5/2020
CN 306144998 S 5/2020
CN 305982962 S 8/2020
EM 000099031-0001 2/2004
EP 004688521-0002 2/2018
EP 005802618-0001 10/2018
JP D1653983 3/2020
WO D202095-0002 2/2019

(51) **LOC (14) Cl.** **23-04**
(52) **U.S. Cl.**
USPC **D23/366**
(58) **Field of Classification Search**
USPC D23/209, 355, 356, 358, 359, 360, 364,
D23/365, 366, 367
CPC . A61L 9/03; A61L 9/012; A61L 9/015; A61L
9/037; F41J 1/01
See application file for complete search history.

(56) **References Cited**
U.S. PATENT DOCUMENTS
D489,802 S * 5/2004 Osbern D23/366
D641,261 S * 7/2011 Diss D9/556
D662,652 S * 6/2012 Browder D26/134
D717,769 S * 11/2014 Wong D14/216
D735,164 S * 7/2015 Lin D14/216
D751,682 S * 3/2016 Nechita D23/366
D762,279 S * 7/2016 Flournoy D23/207
D842,446 S * 3/2019 Wen D23/366
D845,458 S * 4/2019 Fang D23/365
D893,011 S * 8/2020 Lin D23/366
D912,798 S * 3/2021 Oura D23/366

OTHER PUBLICATIONS

“Lyngby vase midnight blue matte—25 cm”; Saved by: Joe Cranberry; Pinterest.ch; <https://www.pinterest.ch/pin/832180837394235954/>; Located via Google Images on Feb. 15, 2015.

* cited by examiner

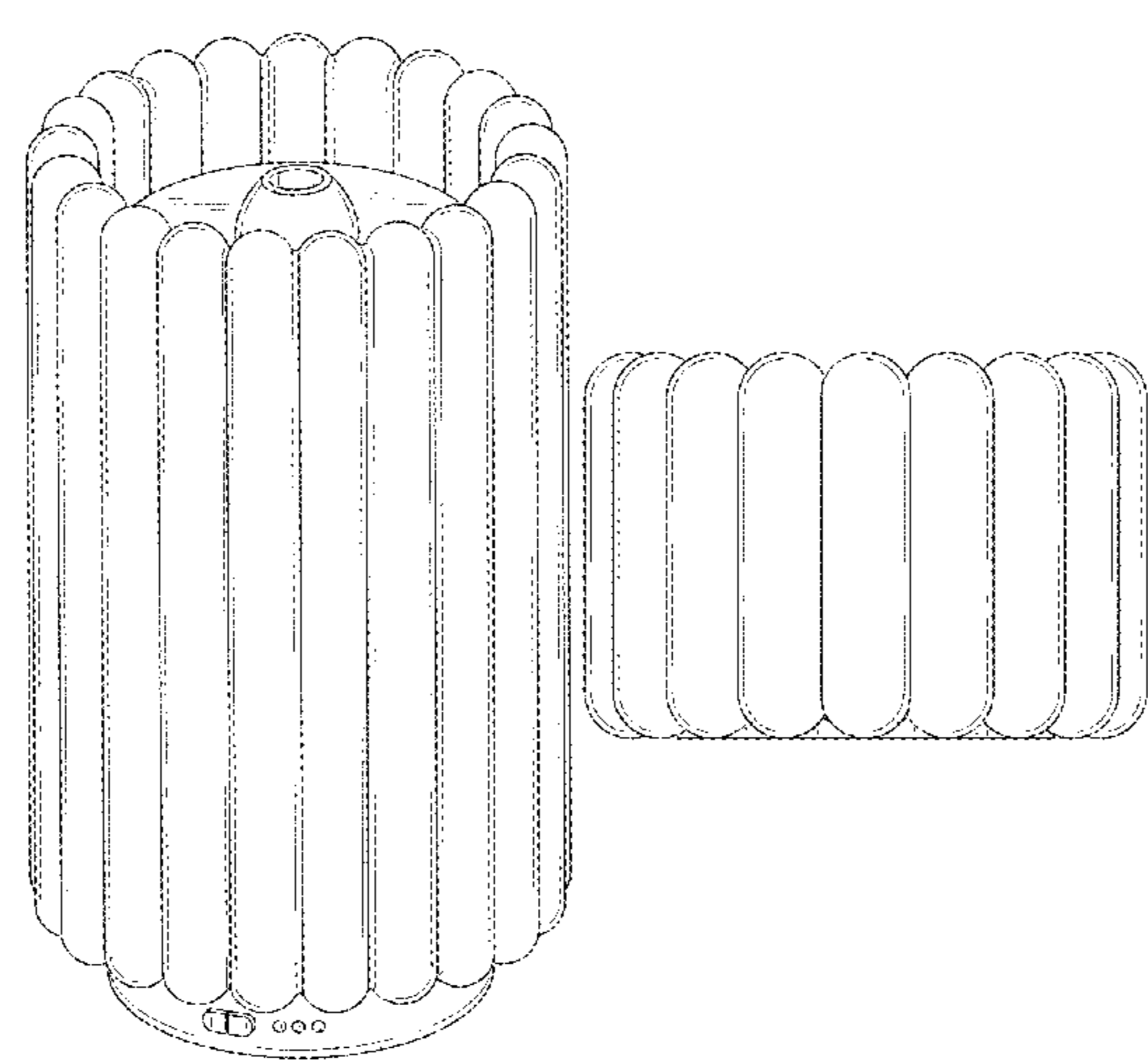

Primary Examiner — John A Voytek
 (74) Attorney, Agent, or Firm — Hamre, Schumann,
 Mueller & Larson, P.C.

(57) **CLAIM**

The ornamental design for an aroma diffuser, as shown and described.

DESCRIPTION

FIG. 1 is a top view of an aroma diffuser.
 FIG. 2 is a bottom view of the diffuser of FIG. 1.
 FIG. 3 is a front view of the diffuser of FIG. 1.
 FIG. 4 is a rear view of the diffuser of FIG. 1.
 FIG. 5 is a left side view of the diffuser of FIG. 1.
 FIG. 6 is a right side view of the diffuser of FIG. 1.
 FIG. 7 is an orthographic view of the upper end of the diffuser of FIG. 1.
 FIG. 8 is an orthographic view of the lower end of the diffuser of FIG. 1.
 FIG. 9 is a top view of an aroma diffuser.
 FIG. 10 is a bottom view of the diffuser of FIG. 9.
 FIG. 11 is a front view of the diffuser of FIG. 9.
 FIG. 12 is a rear view of the diffuser of FIG. 9.
 FIG. 13 is a left side view of the diffuser of FIG. 9.
 FIG. 14 is a right side view of the diffuser of FIG. 9.
 FIG. 15 is an orthographic view of the upper end of the diffuser of FIG. 9.
 FIG. 16 is an orthographic view of the lower end of the diffuser of FIG. 9.
 FIG. 17 is a top view of an aroma diffuser.
 FIG. 18 is a bottom view of the diffuser of FIG. 17.
 FIG. 19 is a front view of the diffuser of FIG. 17.
 FIG. 20 is a rear view of the diffuser of FIG. 17.
 FIG. 21 is a left side view of the diffuser of FIG. 17.
 FIG. 22 is a right side view of the diffuser of FIG. 17.
 FIG. 23 is an orthographic view of the upper end of the diffuser of FIG. 17.
 FIG. 24 is an orthographic view of the lower end of the diffuser of FIG. 17.
 FIG. 25 is a top view of an aroma diffuser.
 FIG. 26 is a bottom view of the diffuser of FIG. 25.
 FIG. 27 is a front view of the diffuser of FIG. 25.
 FIG. 28 is a rear view of the diffuser of FIG. 25.
 FIG. 29 is a left side view of the diffuser of FIG. 25.
 FIG. 30 is a right side view of the diffuser of FIG. 25.
 FIG. 31 is an orthographic view of the upper end of the diffuser of FIG. 25.
 FIG. 32 is an orthographic view of the lower end of the diffuser of FIG. 25.
 FIG. 33 is a top view of an aroma diffuser.
 FIG. 34 is a bottom view of the diffuser of FIG. 33.
 FIG. 35 is a front view of the diffuser of FIG. 33.
 FIG. 36 is a rear view of the diffuser of FIG. 33.
 FIG. 36 is a left side view of the diffuser of FIG. 33.
 FIG. 38 is a right side view of the diffuser of FIG. 33.
 FIG. 39 is an orthographic view of the upper end of the diffuser of FIG. 33.
 FIG. 40 is an orthographic view of the lower end of the diffuser of FIG. 33.
 FIG. 41 is a top view of an aroma diffuser.
 FIG. 42 is a bottom view of the diffuser of FIG. 41.
 FIG. 43 is a front view of the diffuser of FIG. 41.
 FIG. 44 is a rear view of the diffuser of FIG. 41.
 FIG. 45 is a left side view of the diffuser of FIG. 41.

FIG. 46 is a right side view of the diffuser of FIG. 41.
 FIG. 47 is an orthographic view of the upper end of the diffuser of FIG. 41.
 FIG. 48 is an orthographic view of the lower end of the diffuser of FIG. 41.
 FIG. 49 is a top view of an aroma diffuser.
 FIG. 50 is a bottom view of the diffuser of FIG. 49.
 FIG. 51 is a front view of the diffuser of FIG. 49.
 FIG. 52 is a rear view of the diffuser of FIG. 49.
 FIG. 53 is a left side view of the diffuser of FIG. 49.
 FIG. 54 is a right side view of the diffuser of FIG. 49.
 FIG. 55 is an orthographic view of the upper end of the diffuser of FIG. 49.
 FIG. 56 is an orthographic view of the lower end of the diffuser of FIG. 49.
 FIG. 57 is a top view of an aroma diffuser.
 FIG. 58 is a bottom view of the diffuser of FIG. 57.
 FIG. 59 is a front view of the diffuser of FIG. 57.
 FIG. 60 is a rear view of the diffuser of FIG. 57.
 FIG. 61 is a left side view of the diffuser of FIG. 57.
 FIG. 62 is a right side view of the diffuser of FIG. 57.
 FIG. 63 is an orthographic view of the upper end of the diffuser of FIG. 57.
 FIG. 64 is an orthographic view of the lower end of the diffuser of FIG. 57.
 FIG. 65 is a top view of an aroma diffuser.
 FIG. 66 is a bottom view of the diffuser of FIG. 65.
 FIG. 67 is a front view of the diffuser of FIG. 65.
 FIG. 68 is a rear view of the diffuser of FIG. 65.
 FIG. 69 is a left side view of the diffuser of FIG. 65.
 FIG. 70 is a right side view of the diffuser of FIG. 65.
 FIG. 71 is an orthographic view of the upper end of the diffuser of FIG. 65.
 FIG. 72 is an orthographic view of the lower end of the diffuser of FIG. 65.
 FIG. 73 is a top view of an aroma diffuser.
 FIG. 74 is a bottom view of the diffuser of FIG. 73.
 FIG. 75 is a front view of the diffuser of FIG. 73.
 FIG. 76 is a rear view of the diffuser of FIG. 73.
 FIG. 77 is a left side view of the diffuser of FIG. 73.
 FIG. 78 is a right side view of the diffuser of FIG. 73.
 FIG. 79 is an orthographic view of the upper end of the diffuser of FIG. 73.
 FIG. 80 is an orthographic view of the lower end of the diffuser of FIG. 73.
 FIG. 81 is a top view of an aroma diffuser.
 FIG. 82 is a bottom view of the diffuser of FIG. 81.
 FIG. 83 is a front view of the diffuser of FIG. 81.
 FIG. 84 is a rear view of the diffuser of FIG. 81.
 FIG. 85 is a left side view of the diffuser of FIG. 81.
 FIG. 86 is a right side view of the diffuser of FIG. 81.
 FIG. 87 is an orthographic view of the upper end of the diffuser of FIG. 81.
 FIG. 88 is an orthographic view of the lower end of the diffuser of FIG. 81.
 FIG. 89 is a top view of an aroma diffuser.
 FIG. 90 is a bottom view of the diffuser of FIG. 89.
 FIG. 91 is a front view of the diffuser of FIG. 89.
 FIG. 92 is a rear view of the diffuser of FIG. 89.
 FIG. 93 is a left side view of the diffuser of FIG. 89.
 FIG. 94 is a right side view of the diffuser of FIG. 89.
 FIG. 95 is an orthographic view of the upper end of the diffuser of FIG. 89.
 FIG. 96 is an orthographic view of the lower end of the diffuser of FIG. 89.

FIG. 97 is a top view of an aroma diffuser.
 FIG. 98 is a bottom view of the diffuser of FIG. 97.
 FIG. 99 is a front view of the diffuser of FIG. 97.
 FIG. 100 is a rear view of the diffuser of FIG. 97.
 FIG. 101 is a left side view of the diffuser of FIG. 97.
 FIG. 102 is a right side view of the diffuser of FIG. 97.
 FIG. 103 is an orthographic view of the upper end of the diffuser of FIG. 97.
 FIG. 104 is an orthographic view of the lower end of the diffuser of FIG. 97.
 FIG. 105 is a top view of an aroma diffuser.
 FIG. 106 is a bottom view of the diffuser of FIG. 105.
 FIG. 107 is a front view of the diffuser of FIG. 105.
 FIG. 108 is a rear view of the diffuser of FIG. 105.
 FIG. 109 is a left side view of the diffuser of FIG. 105.
 FIG. 110 is a right side view of the diffuser of FIG. 105.
 FIG. 111 is an orthographic view of the upper end of the diffuser of FIG. 105.
 FIG. 112 is an orthographic view of the lower end of the diffuser of FIG. 105.
 FIG. 113 is a top view of an aroma diffuser.
 FIG. 114 is a bottom view of the diffuser of FIG. 113.
 FIG. 115 is a front view of the diffuser of FIG. 113.
 FIG. 116 is a rear view of the diffuser of FIG. 113.
 FIG. 117 is a left side view of the diffuser of FIG. 113.
 FIG. 118 is a right side view of the diffuser of FIG. 113.
 FIG. 119 is an orthographic view of the upper end of the diffuser of FIG. 113.
 FIG. 120 is an orthographic view of the lower end of the diffuser of FIG. 113.
 FIG. 121 is a top view of an aroma diffuser.
 FIG. 122 is a bottom view of the diffuser of FIG. 121.
 FIG. 123 is a front view of the diffuser of FIG. 121.
 FIG. 124 is a rear view of the diffuser of FIG. 121.
 FIG. 125 is a left side view of the diffuser of FIG. 121.
 FIG. 126 is a right side view of the diffuser of FIG. 121.
 FIG. 127 is an orthographic view of the upper end of the diffuser of FIG. 121.
 FIG. 128 is an orthographic view of the lower end of the diffuser of FIG. 121.
 FIG. 129 is a top view of an aroma diffuser.
 FIG. 130 is a bottom view of the diffuser of FIG. 129.
 FIG. 131 is a front view of the diffuser of FIG. 129.
 FIG. 132 is a rear view of the diffuser of FIG. 129.
 FIG. 133 is a left side view of the diffuser of FIG. 129.
 FIG. 134 is a right side view of the diffuser of FIG. 129.
 FIG. 135 is an orthographic view of the upper end of the diffuser of FIG. 129.
 FIG. 136 is an orthographic view of the lower end of the diffuser of FIG. 129.
 FIG. 137 is a top view of an aroma diffuser.
 FIG. 138 is a bottom view of the diffuser of FIG. 137.

FIG. 139 is a front view of the diffuser of FIG. 137.
 FIG. 140 is a rear view of the diffuser of FIG. 137.
 FIG. 141 is a left side view of the diffuser of FIG. 137.
 FIG. 142 is a right side view of the diffuser of FIG. 137.
 FIG. 143 is an orthographic view of the upper end of the diffuser of FIG. 137.
 FIG. 144 is an orthographic view of the lower end of the diffuser of FIG. 137.
 FIG. 145 is a top view of an aroma diffuser.
 FIG. 146 is a bottom view of the diffuser of FIG. 145.
 FIG. 147 is a front view of the diffuser of FIG. 145.
 FIG. 148 is a rear view of the diffuser of FIG. 145.
 FIG. 149 is a left side view of the diffuser of FIG. 145.
 FIG. 150 is a right side view of the diffuser of FIG. 145.
 FIG. 151 is an orthographic view of the upper end of the diffuser of FIG. 145.
 FIG. 152 is an orthographic view of the lower end of the diffuser of FIG. 145.
 FIG. 153 is a top view of an aroma diffuser.
 FIG. 154 is a bottom view of the diffuser of FIG. 153.
 FIG. 155 is a front view of the diffuser of FIG. 153.
 FIG. 156 is a rear view of the diffuser of FIG. 153.
 FIG. 157 is a left side view of the diffuser of FIG. 153.
 FIG. 158 is a right side view of the diffuser of FIG. 153.
 FIG. 159 is an orthographic view of the upper end of the diffuser of FIG. 153.
 FIG. 160 is an orthographic view of the lower end of the diffuser of FIG. 153.
 FIG. 161 is a top view of an aroma diffuser.
 FIG. 162 is a bottom view of the diffuser of FIG. 161.
 FIG. 163 is a front view of the diffuser of FIG. 161.
 FIG. 164 is a rear view of the diffuser of FIG. 161.
 FIG. 165 is a left side view of the diffuser of FIG. 161.
 FIG. 166 is a right side view of the diffuser of FIG. 161.
 FIG. 167 is an orthographic view of the upper end of the diffuser of FIG. 161.
 FIG. 168 is an orthographic view of the lower end of the diffuser of FIG. 161.
 FIG. 169 is a top view of an aroma diffuser.
 FIG. 170 is a bottom view of the diffuser of FIG. 169.
 FIG. 171 is a front view of the diffuser of FIG. 169.
 FIG. 172 is a rear view of the diffuser of FIG. 169.
 FIG. 173 is a left side view of the diffuser of FIG. 169.
 FIG. 174 is a right side view of the diffuser of FIG. 169.
 FIG. 175 is an orthographic view of the upper end of the diffuser of FIG. 169; and,
 FIG. 176 is an orthographic view of the lower end of the diffuser of FIG. 169.
 Any broken lines shown in the figures are for the purpose of illustrating boundaries or environmental structure and form no part of the claimed design.

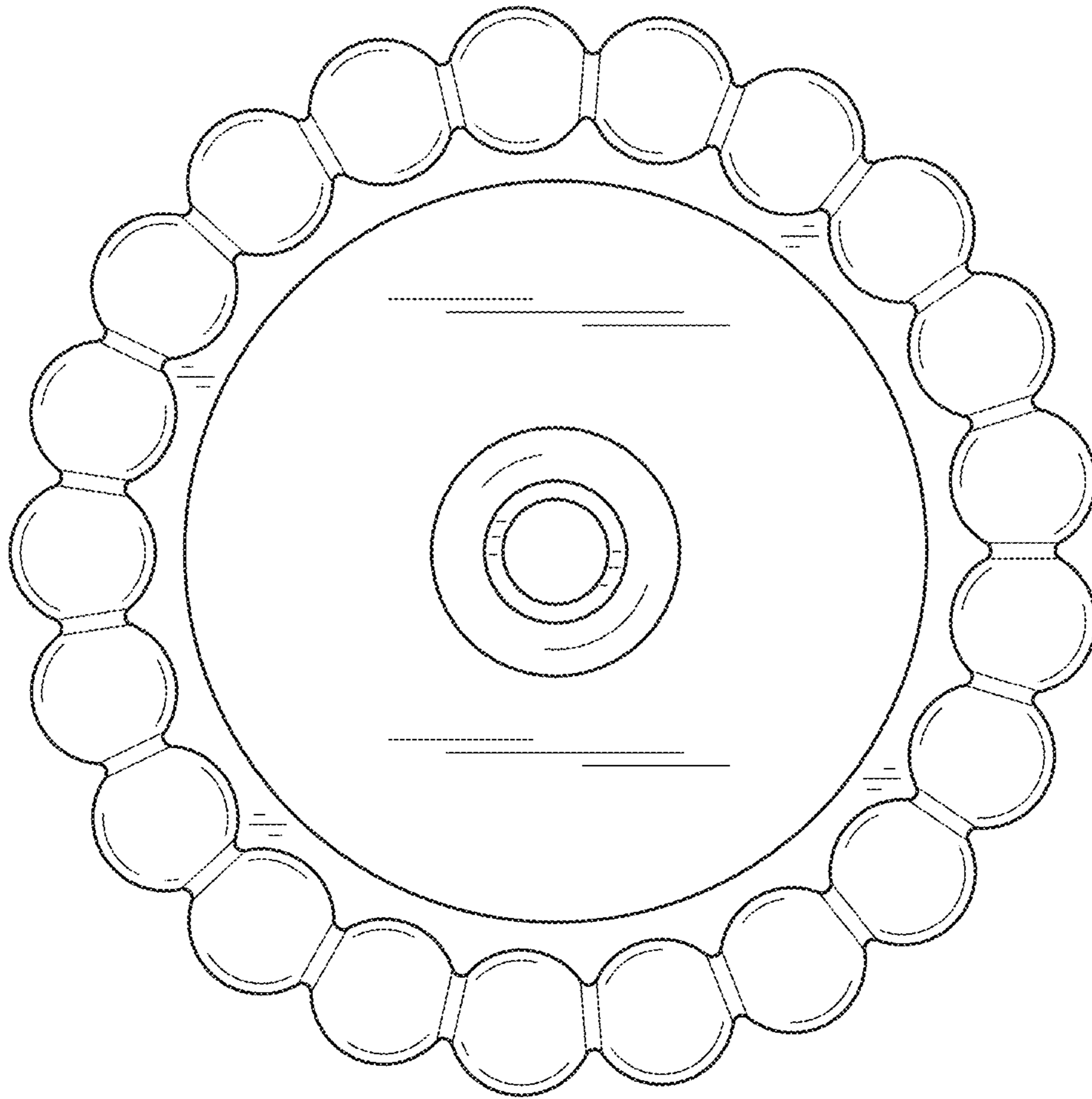

FIG. 1

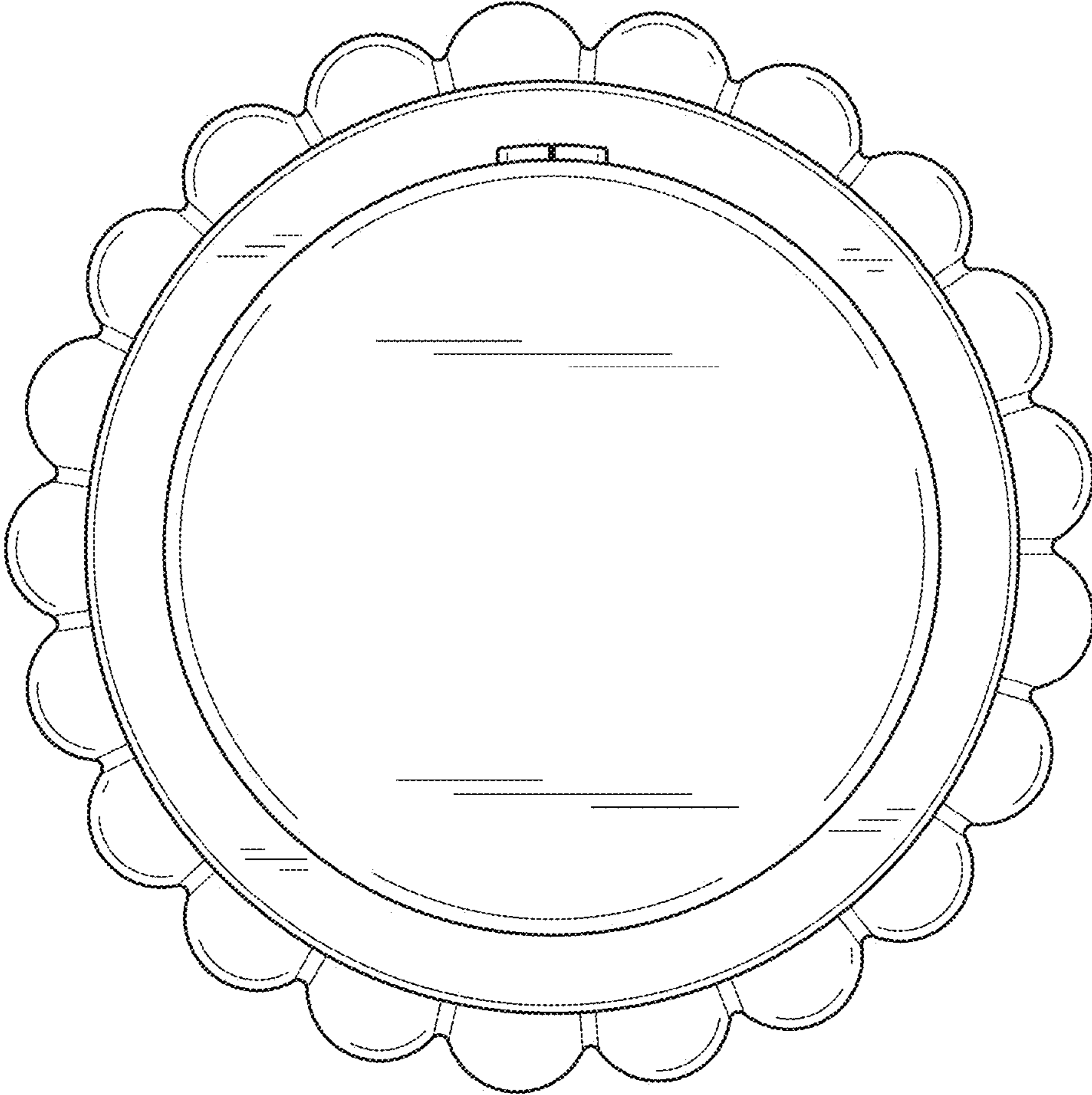

FIG. 2

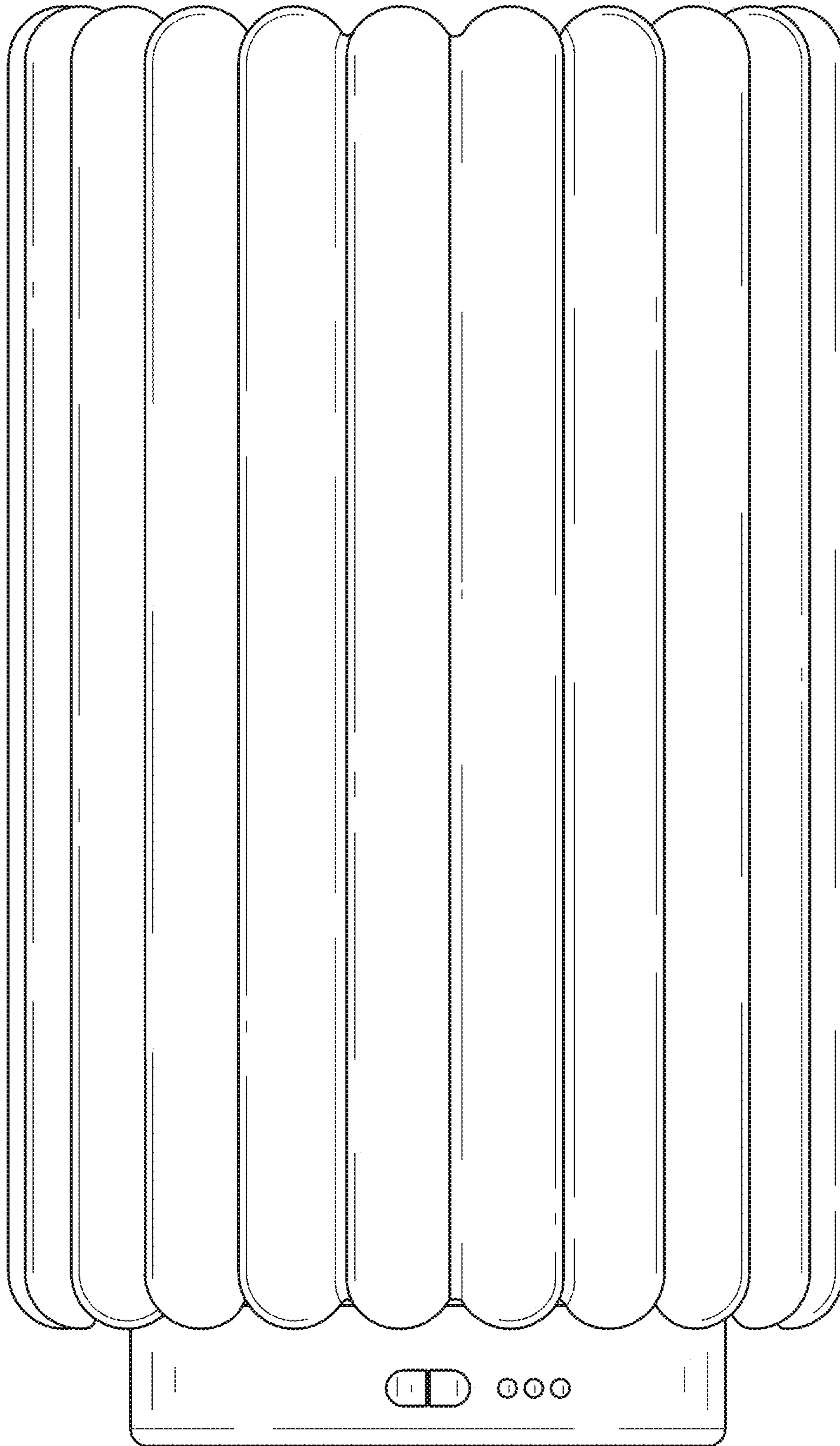

FIG. 3

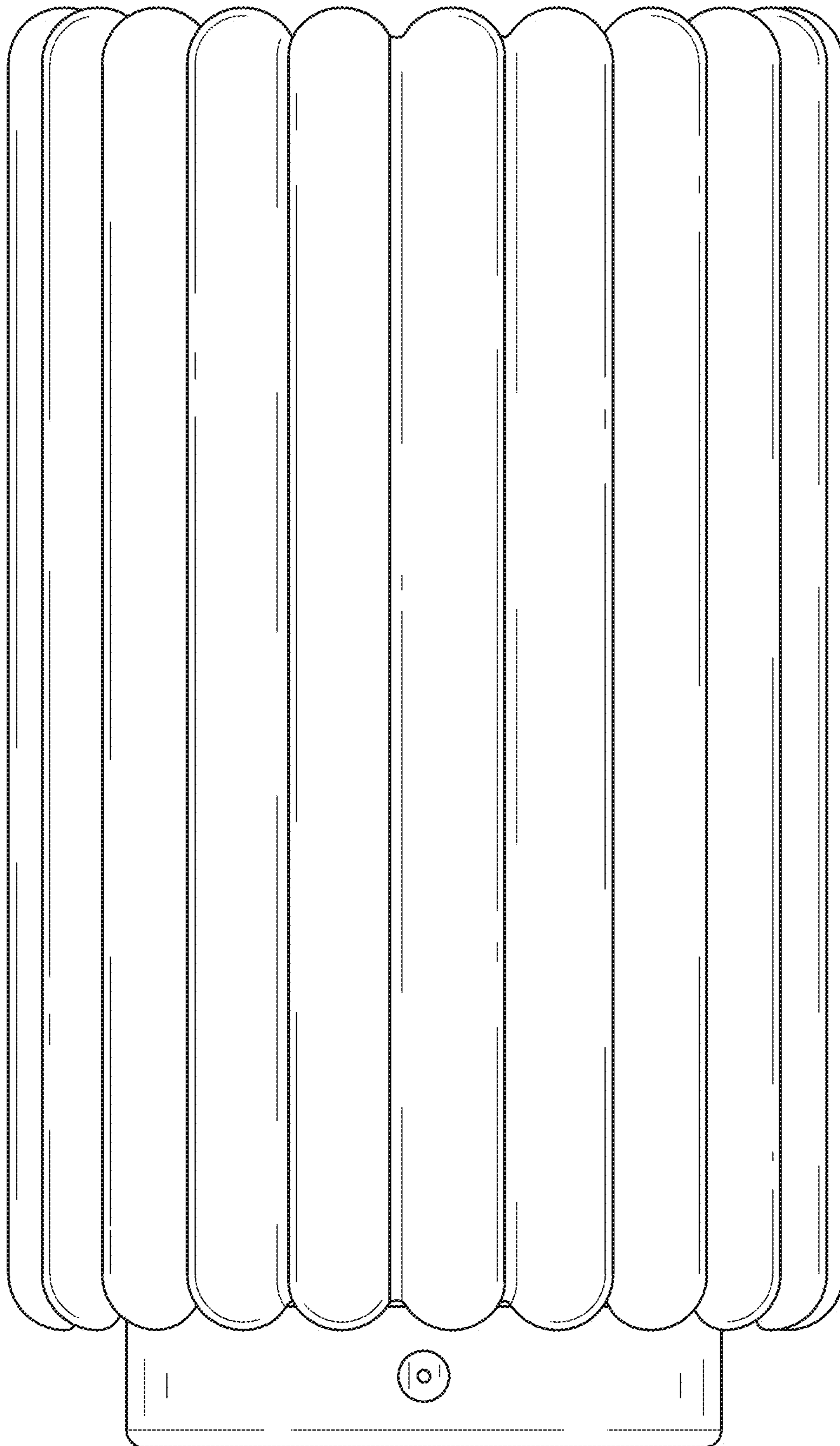

FIG. 4

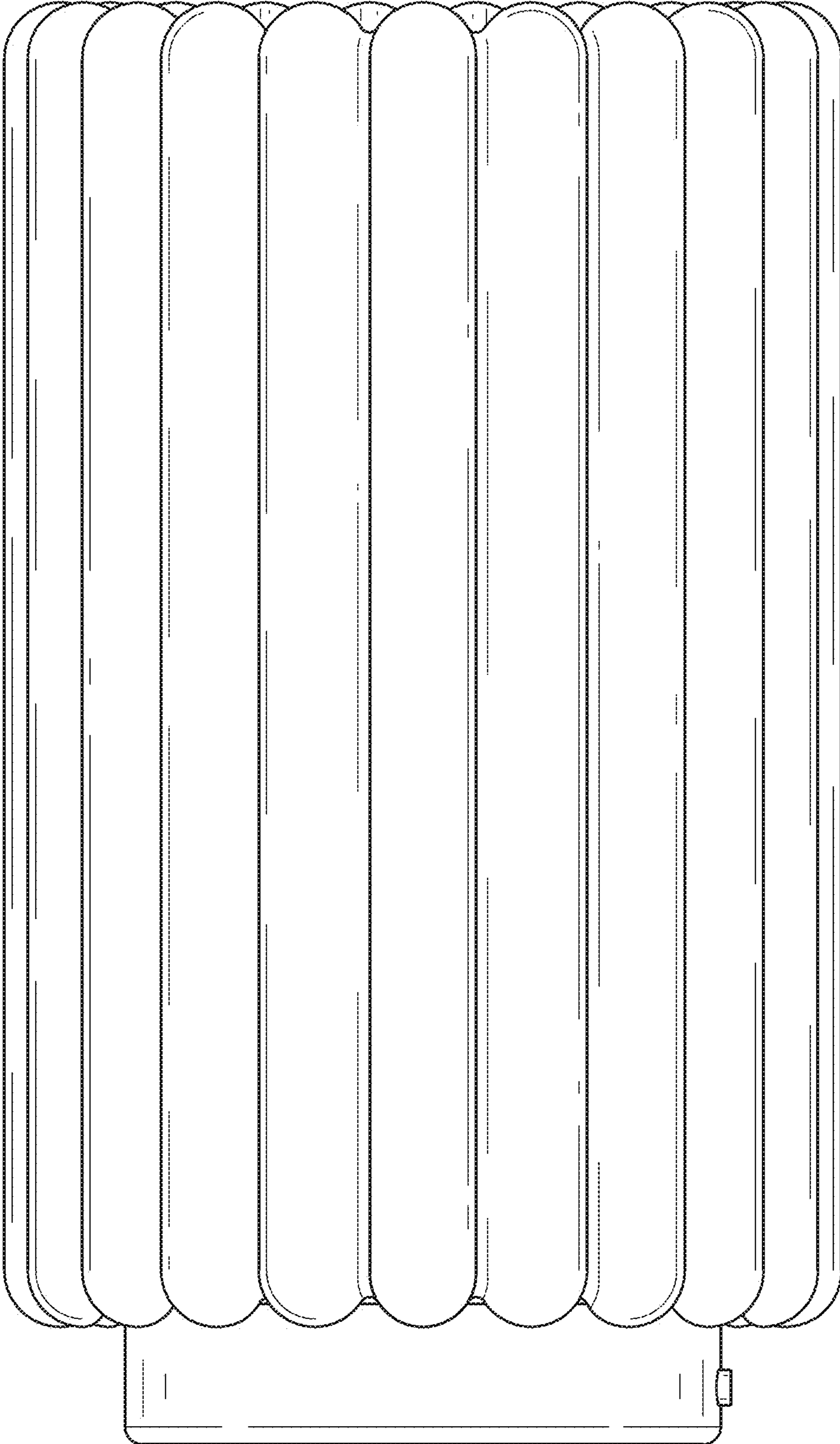

FIG. 5

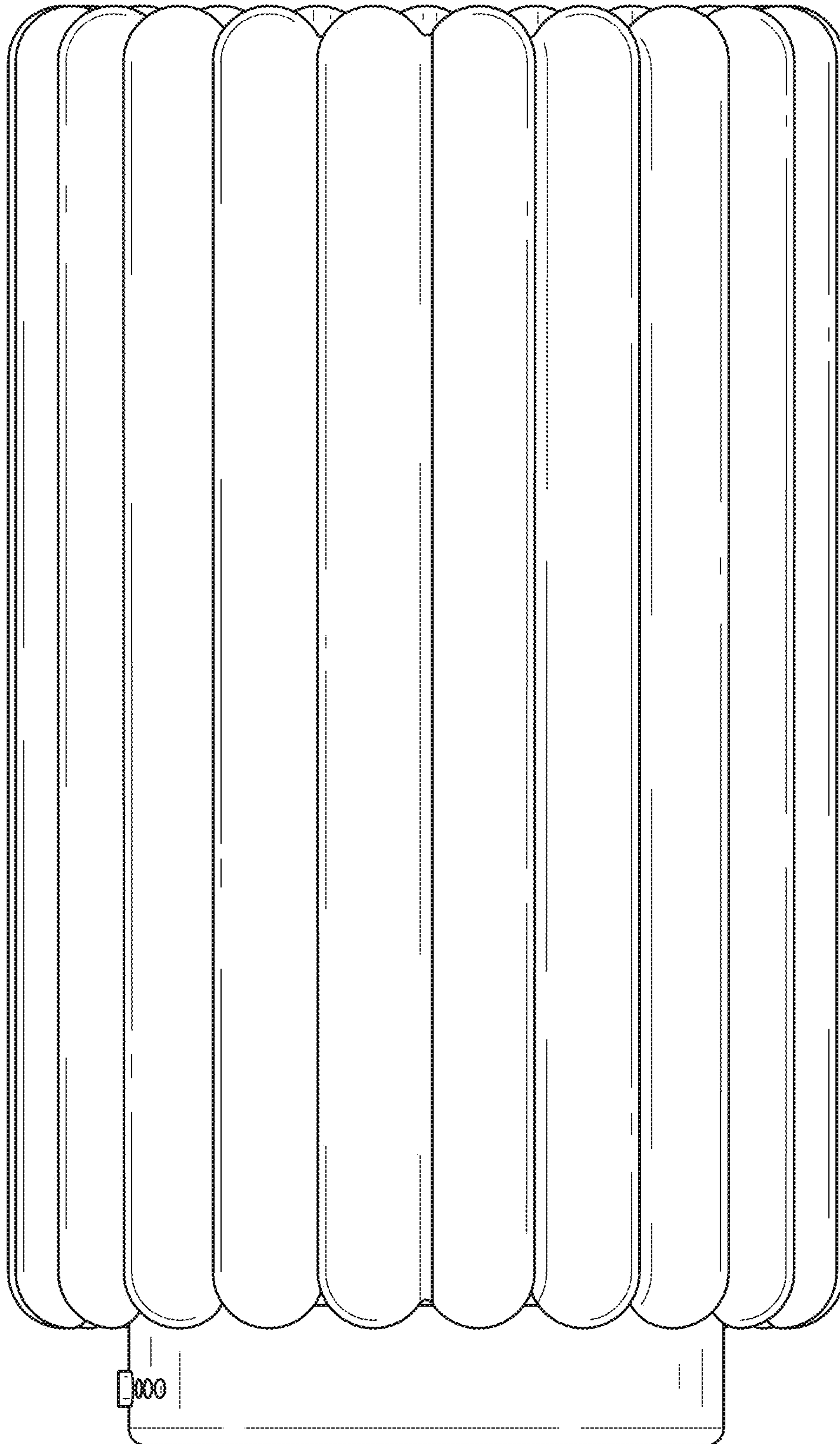

FIG. 6

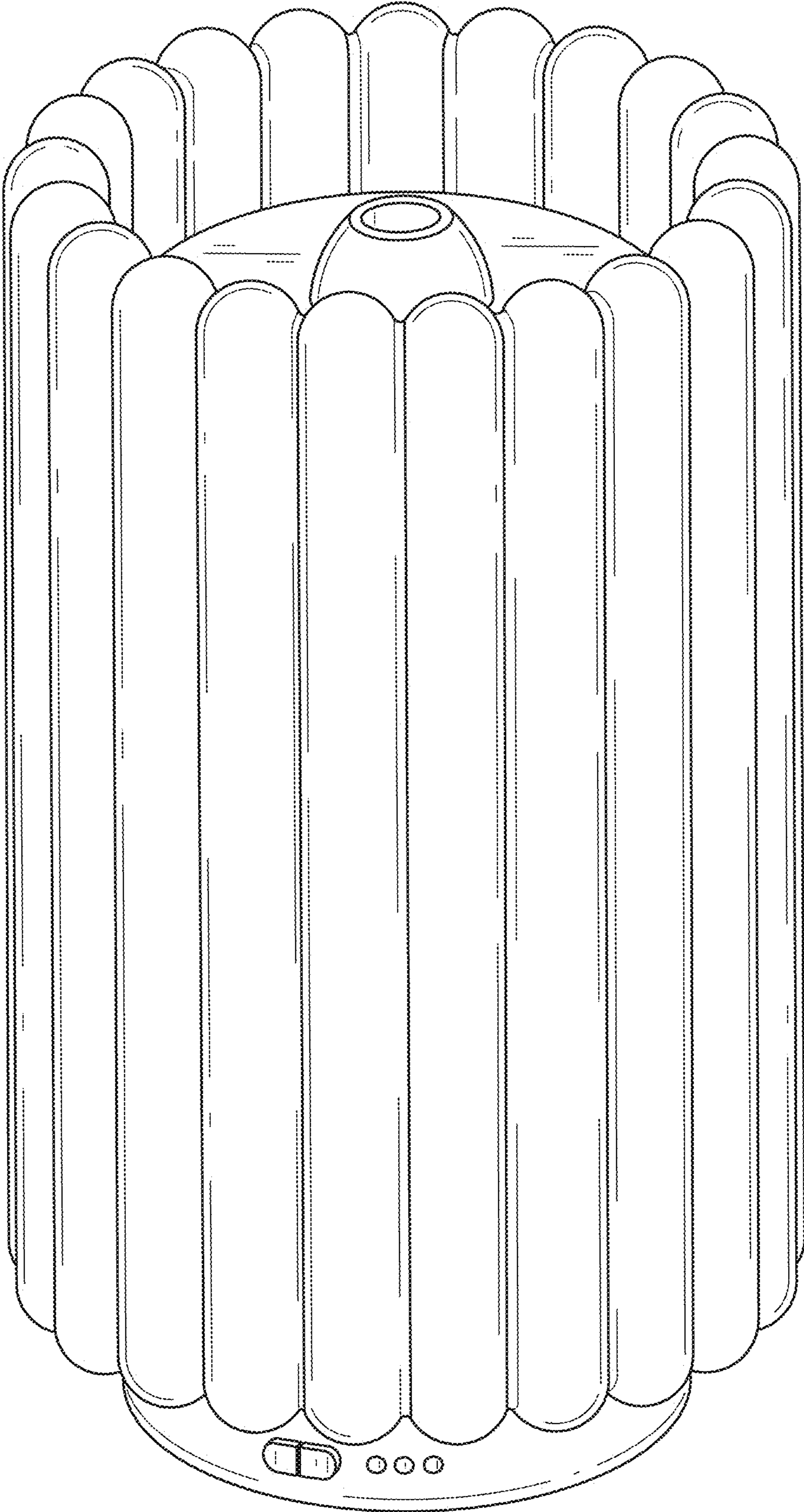

FIG. 7

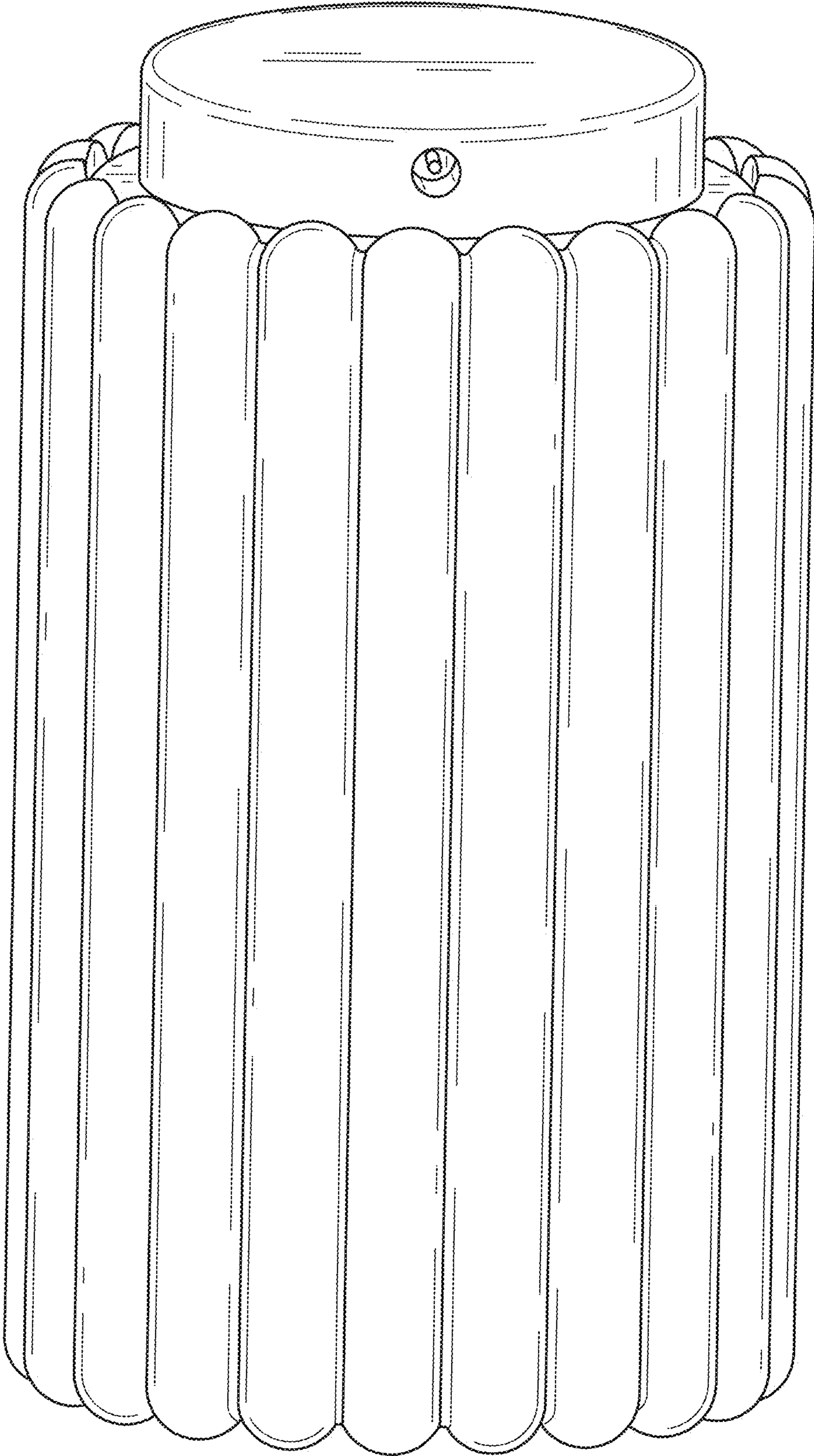

FIG. 8

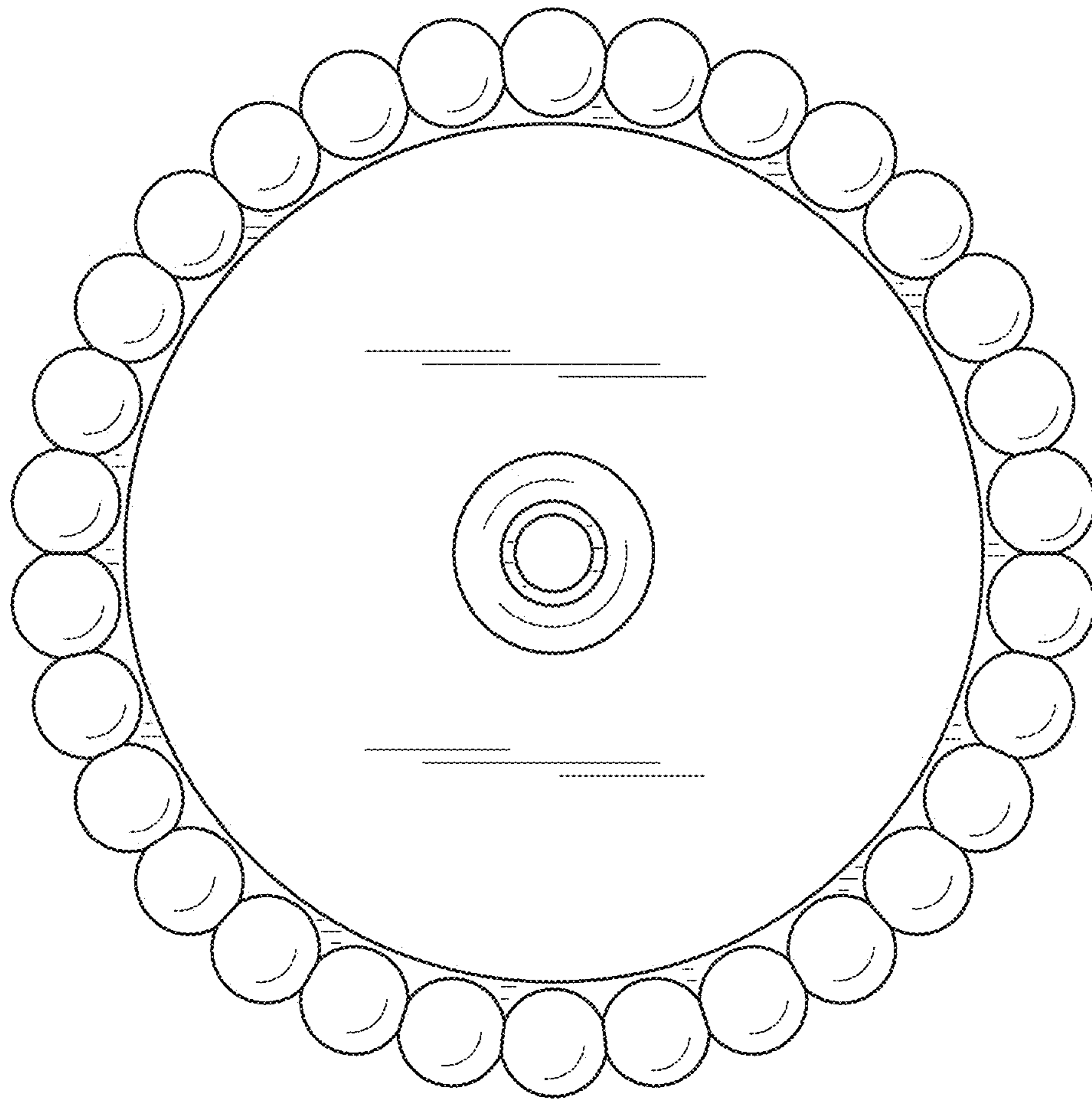

FIG. 9

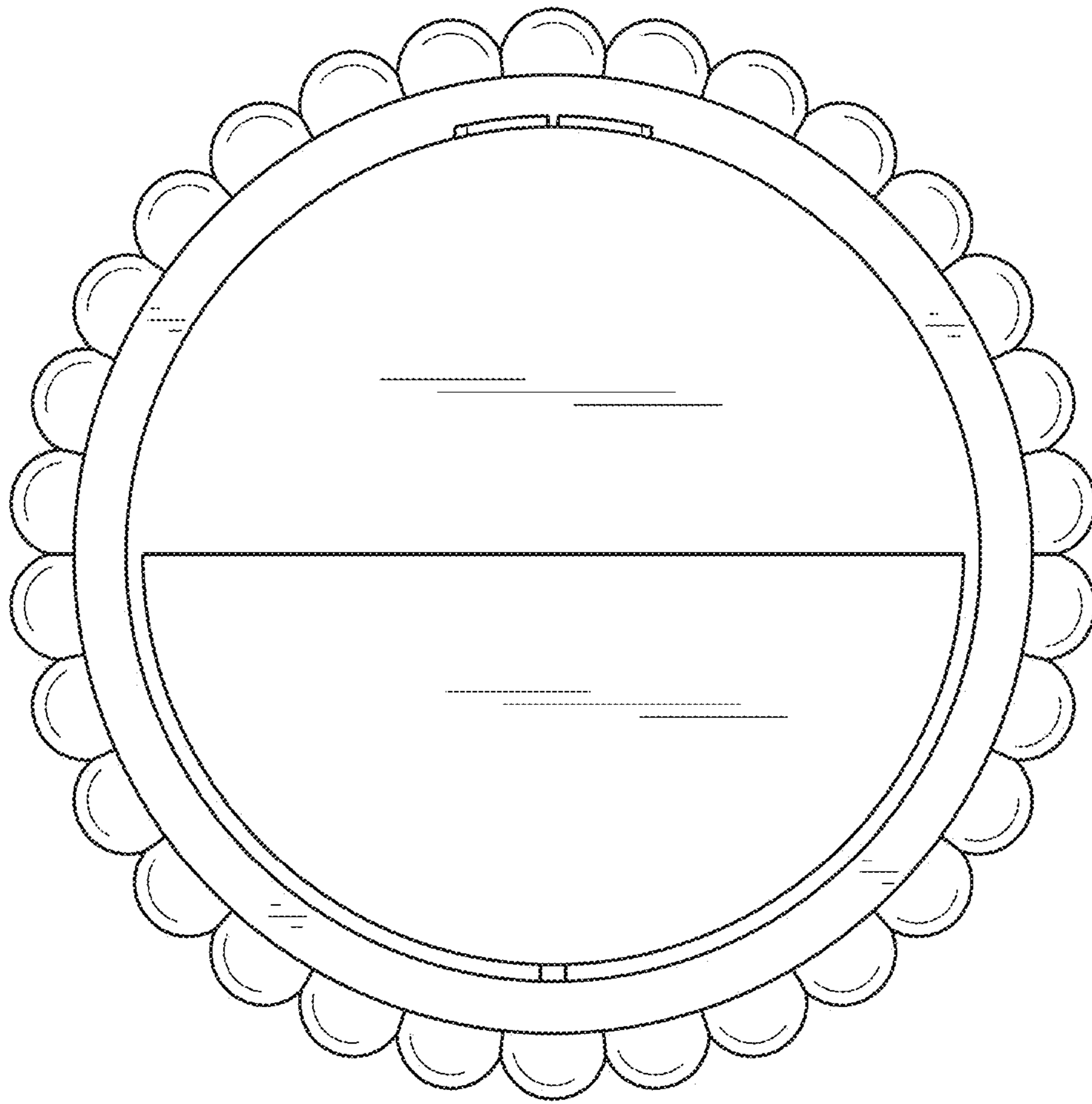

FIG. 10

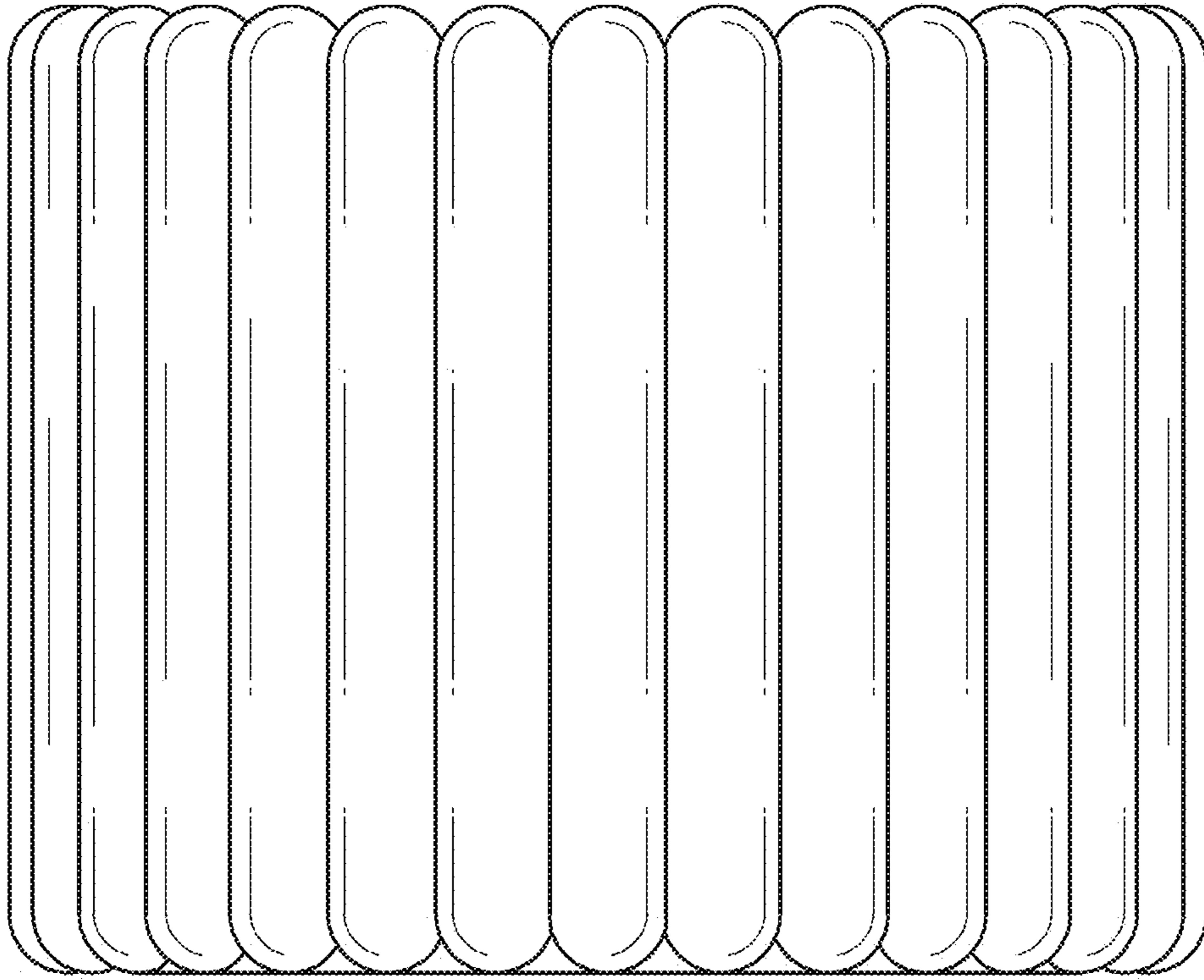

FIG. 11

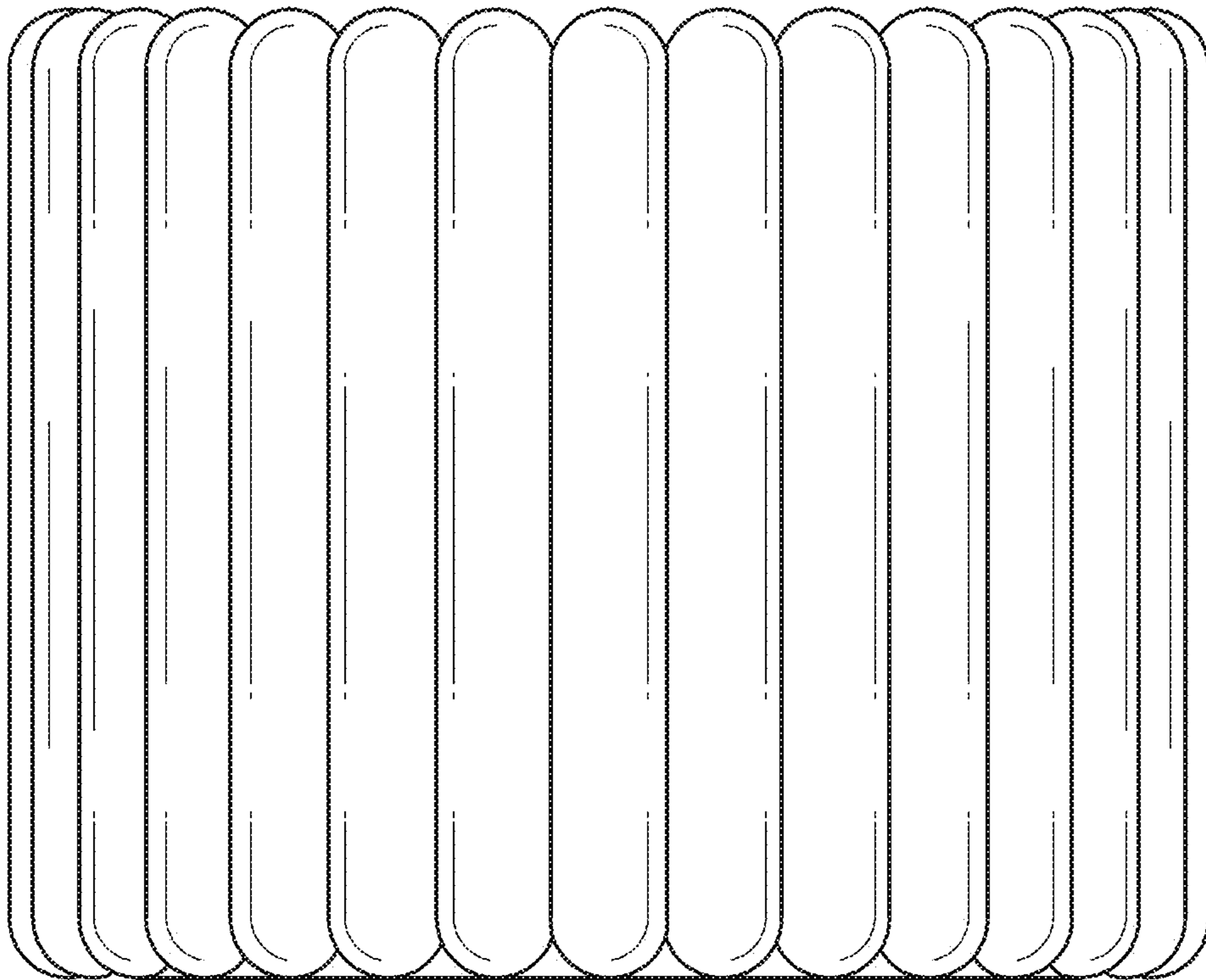

FIG. 12

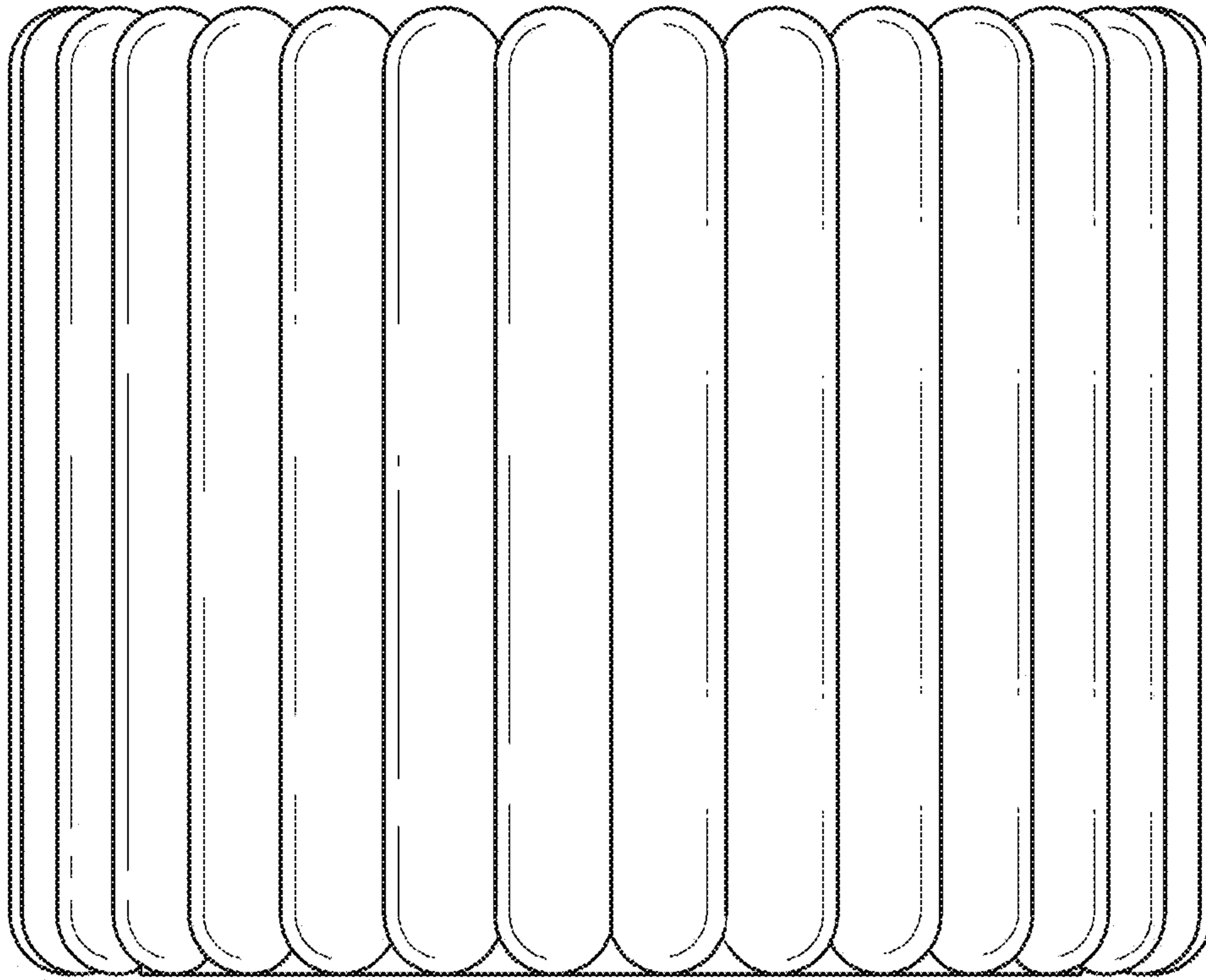

FIG. 13

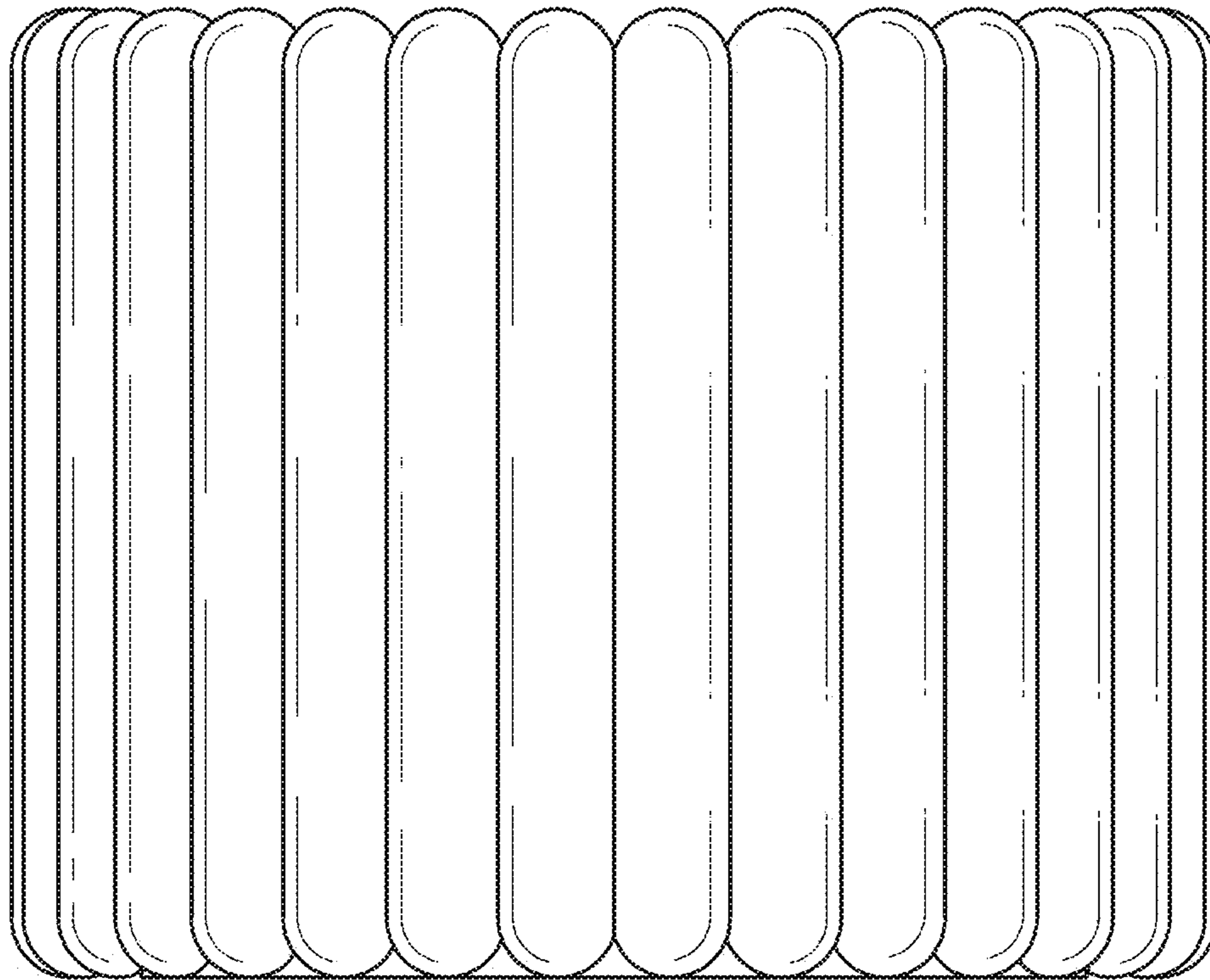

FIG. 14

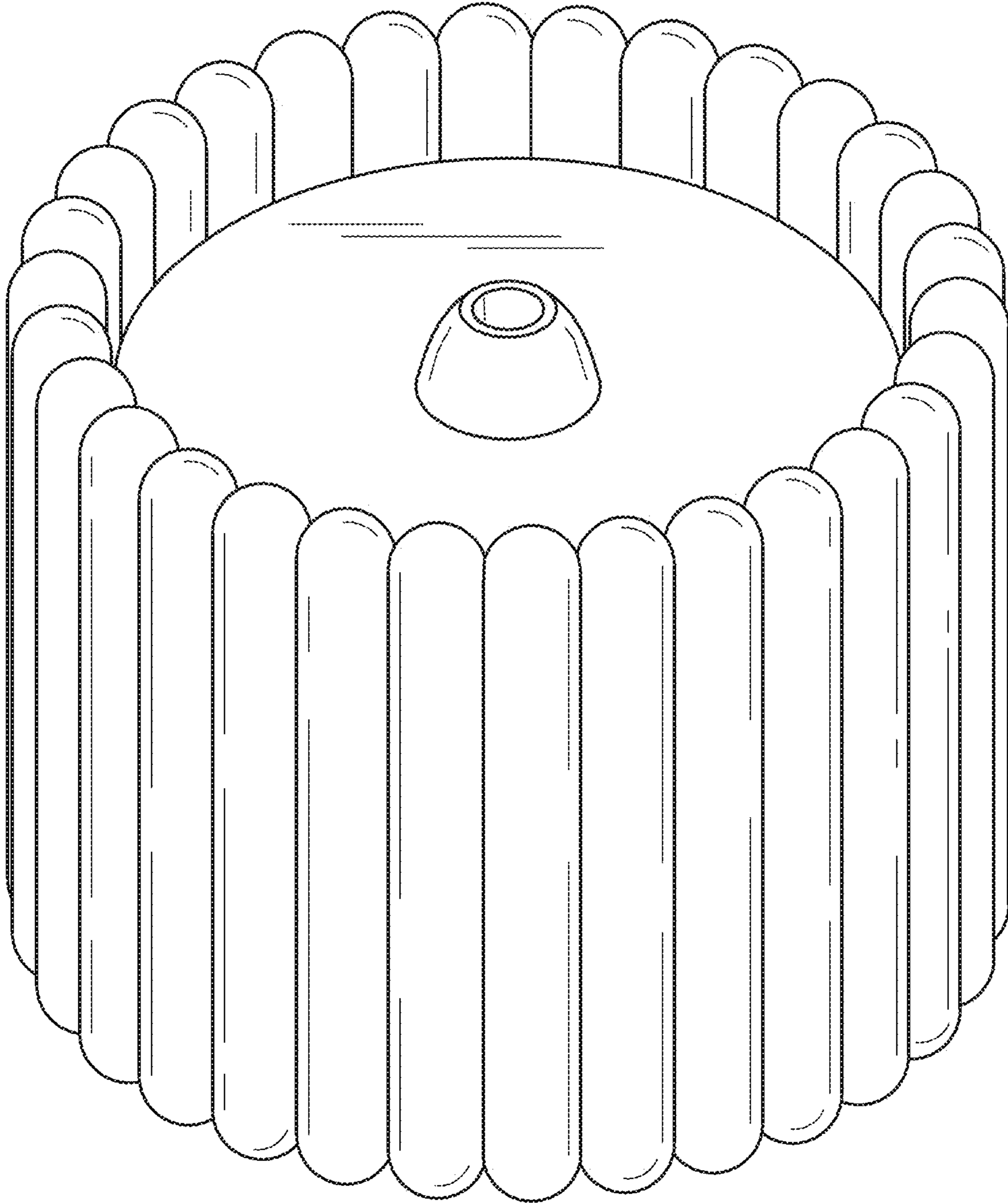

FIG. 15

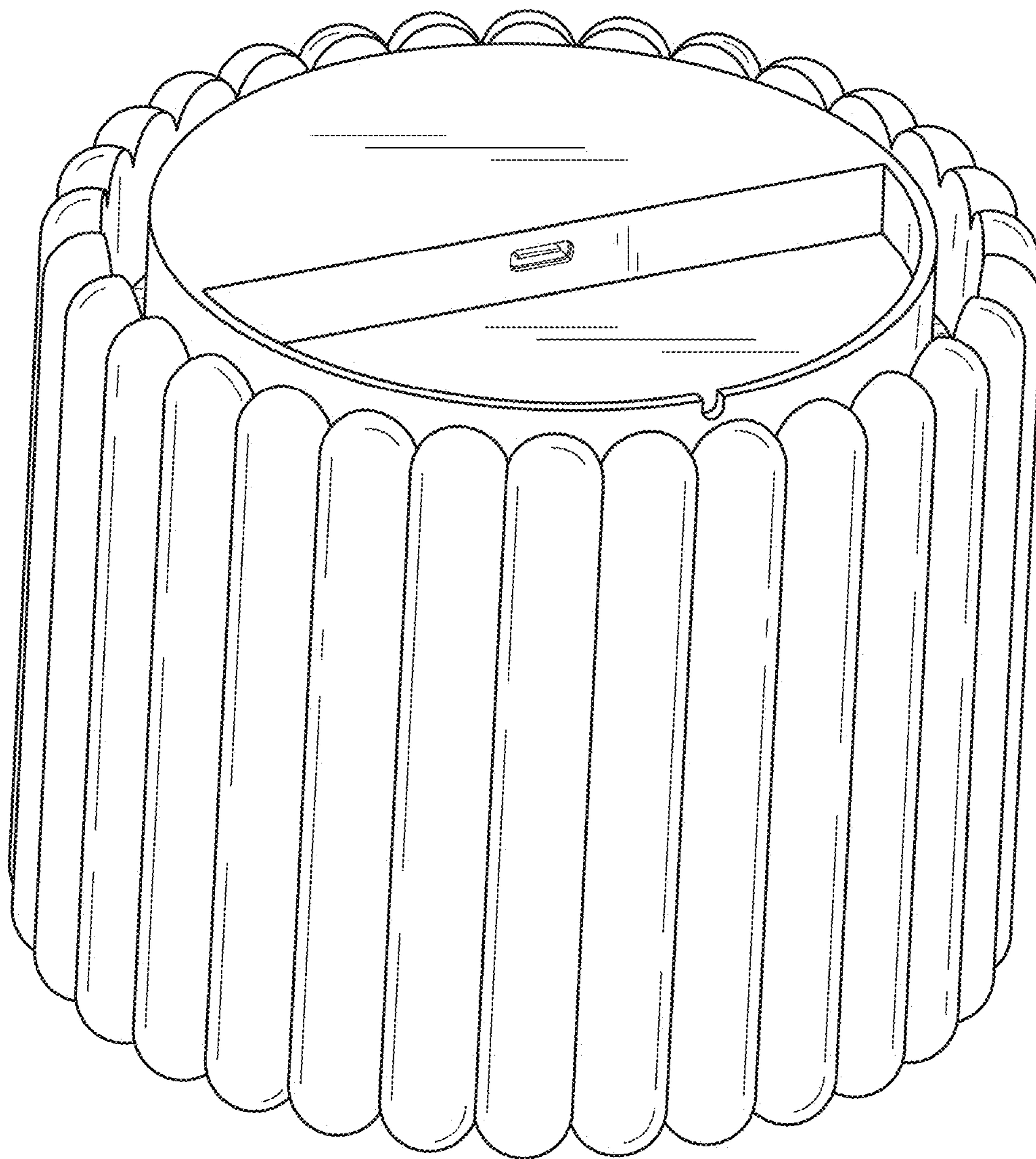

FIG. 16

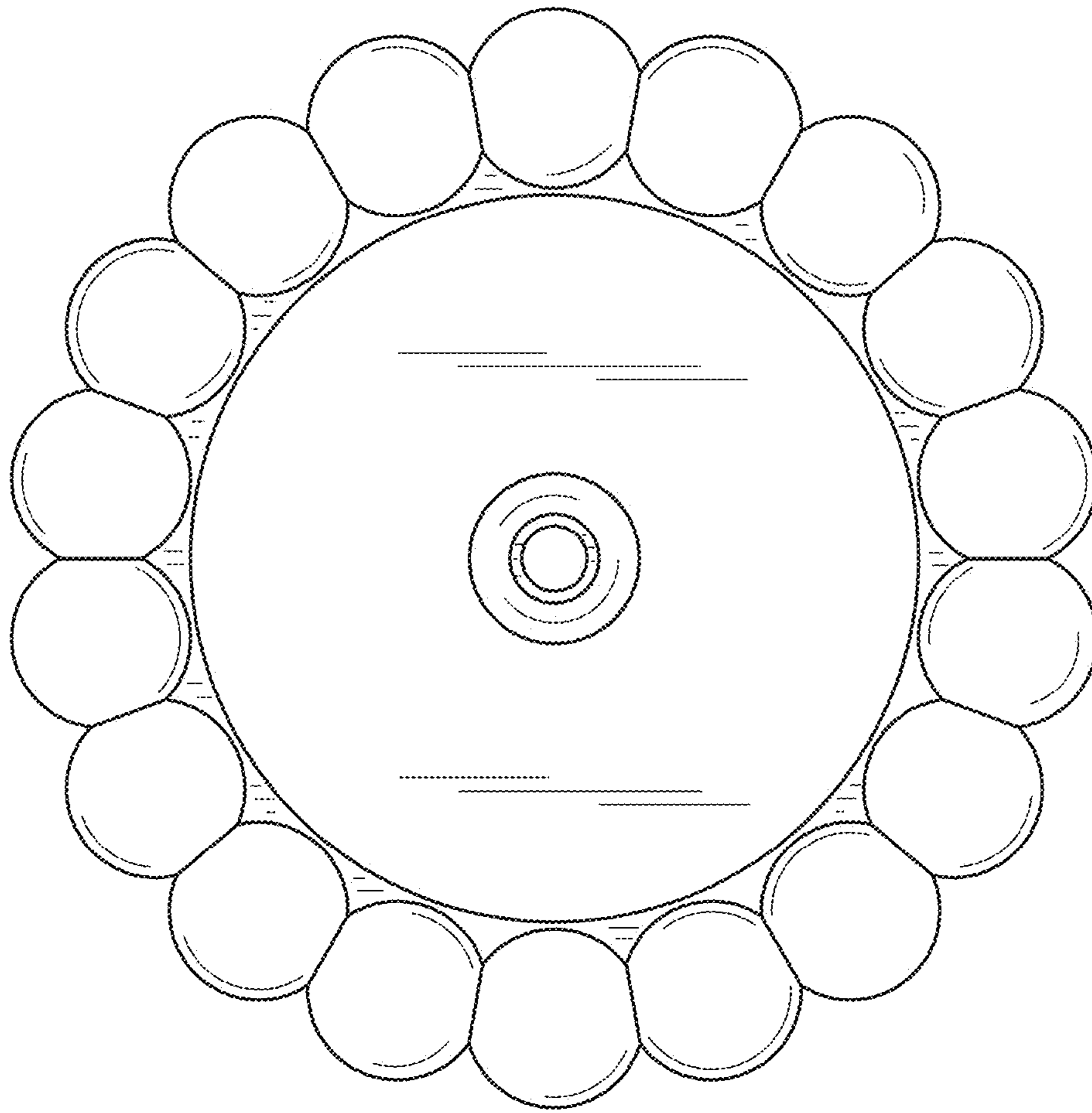

FIG. 17

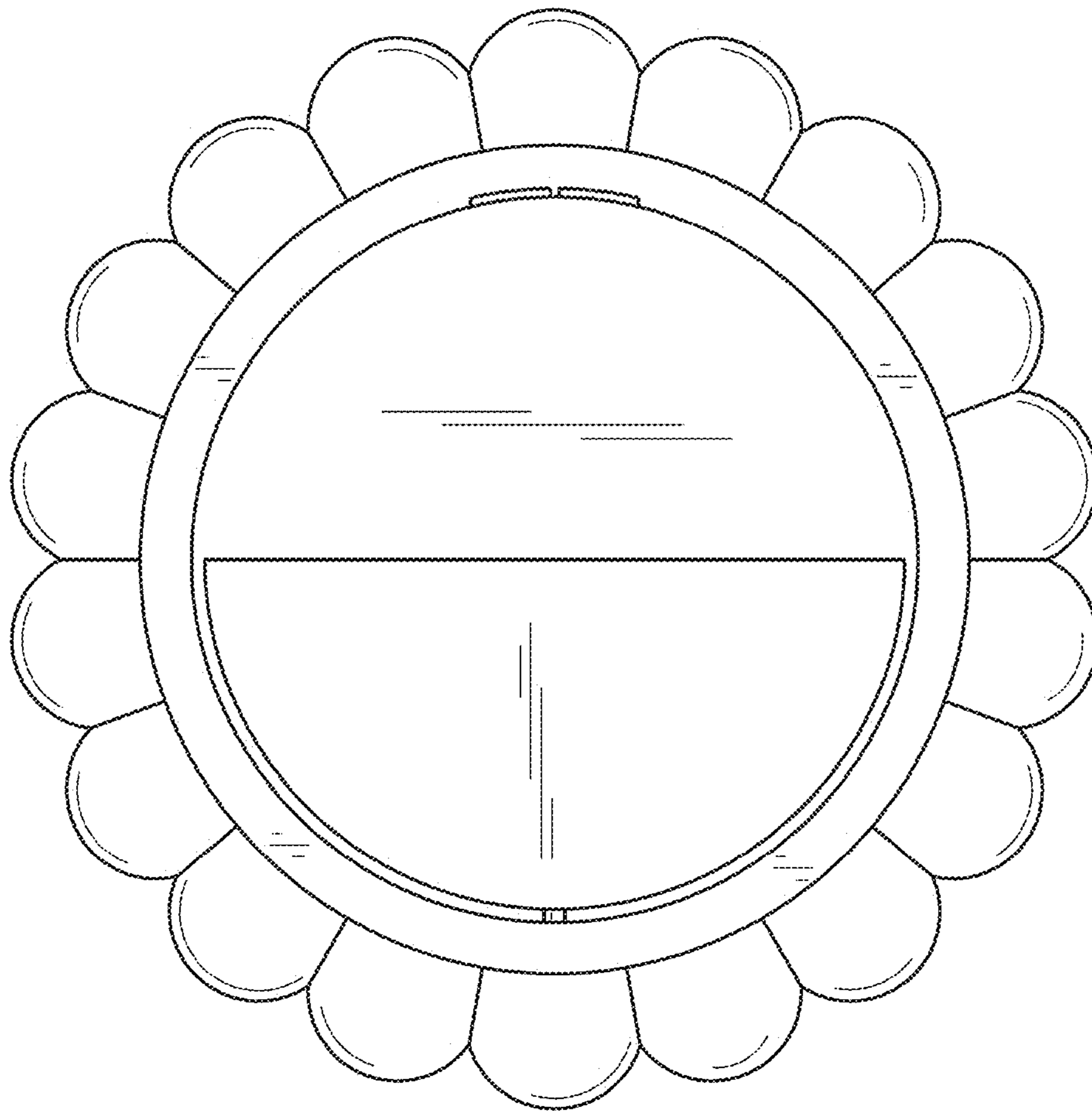

FIG. 18

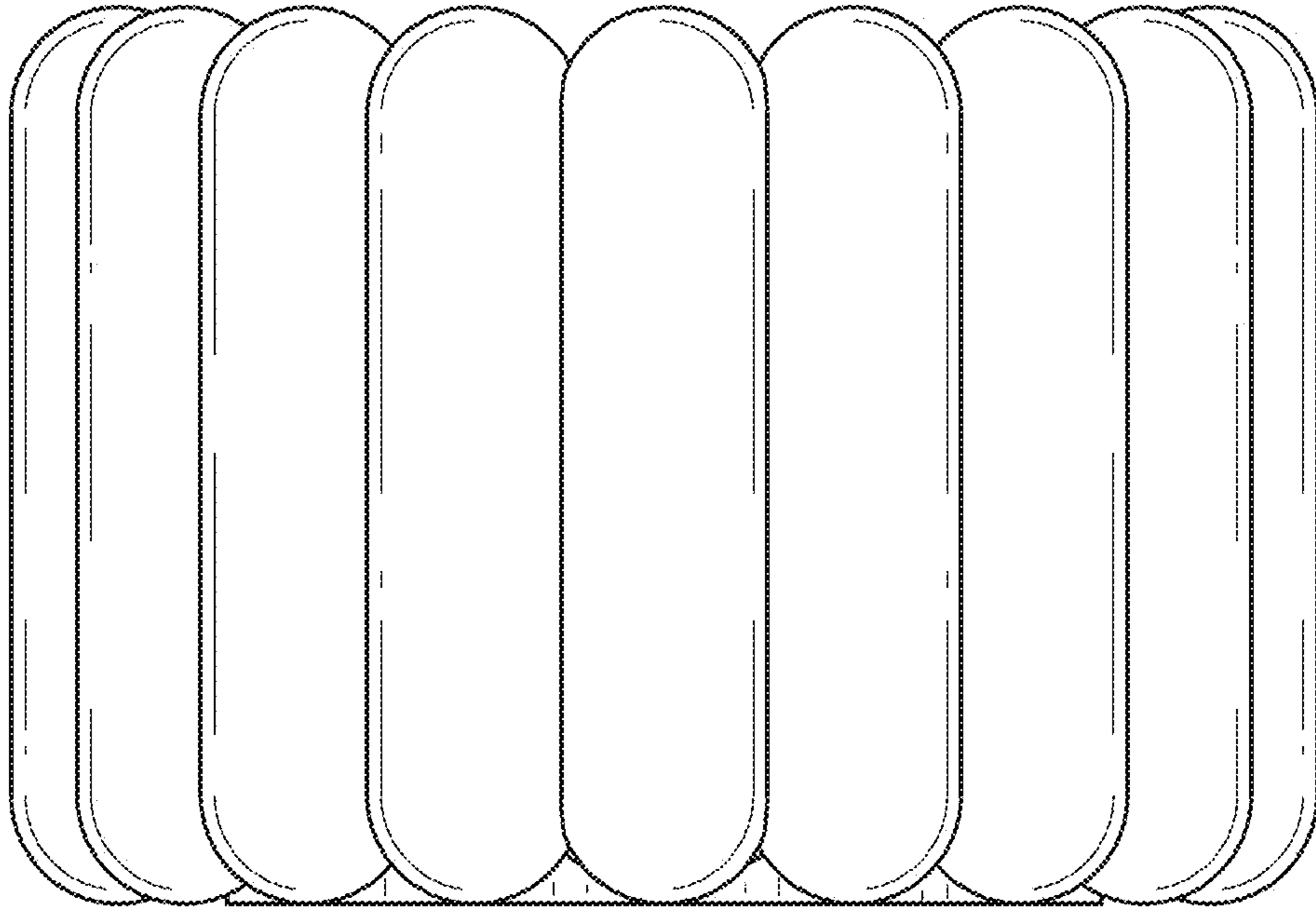

FIG. 19

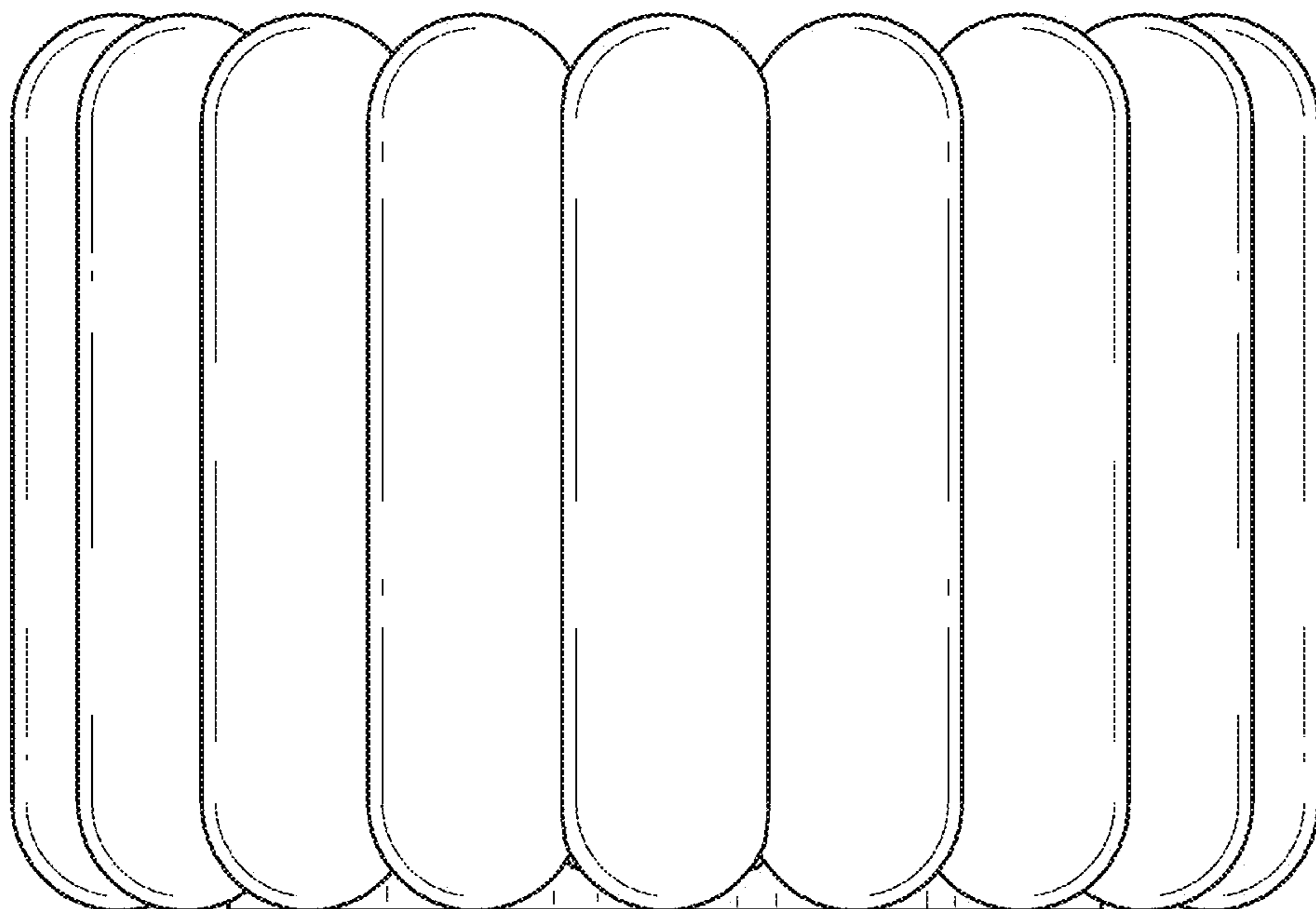

FIG. 20

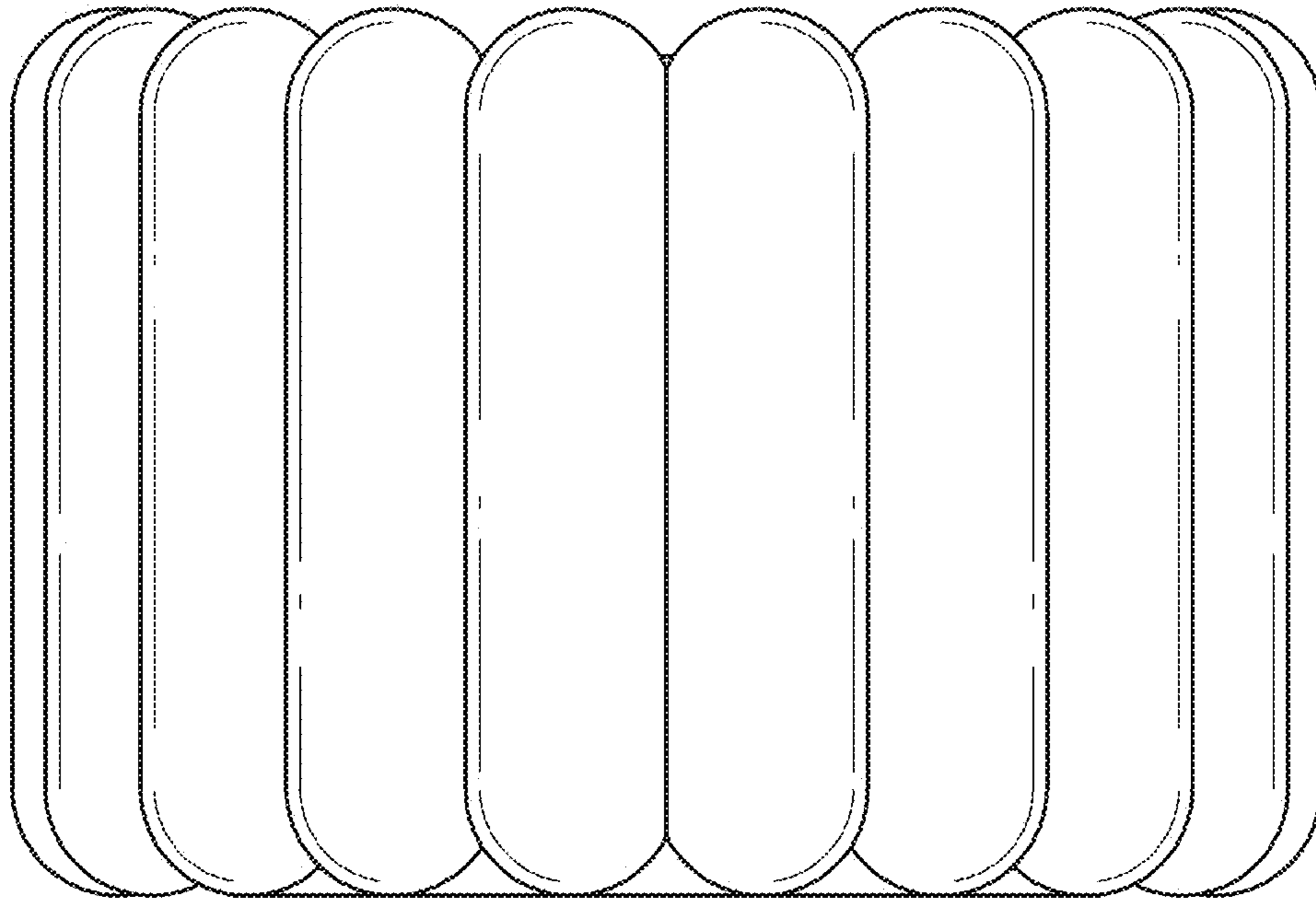

FIG. 21

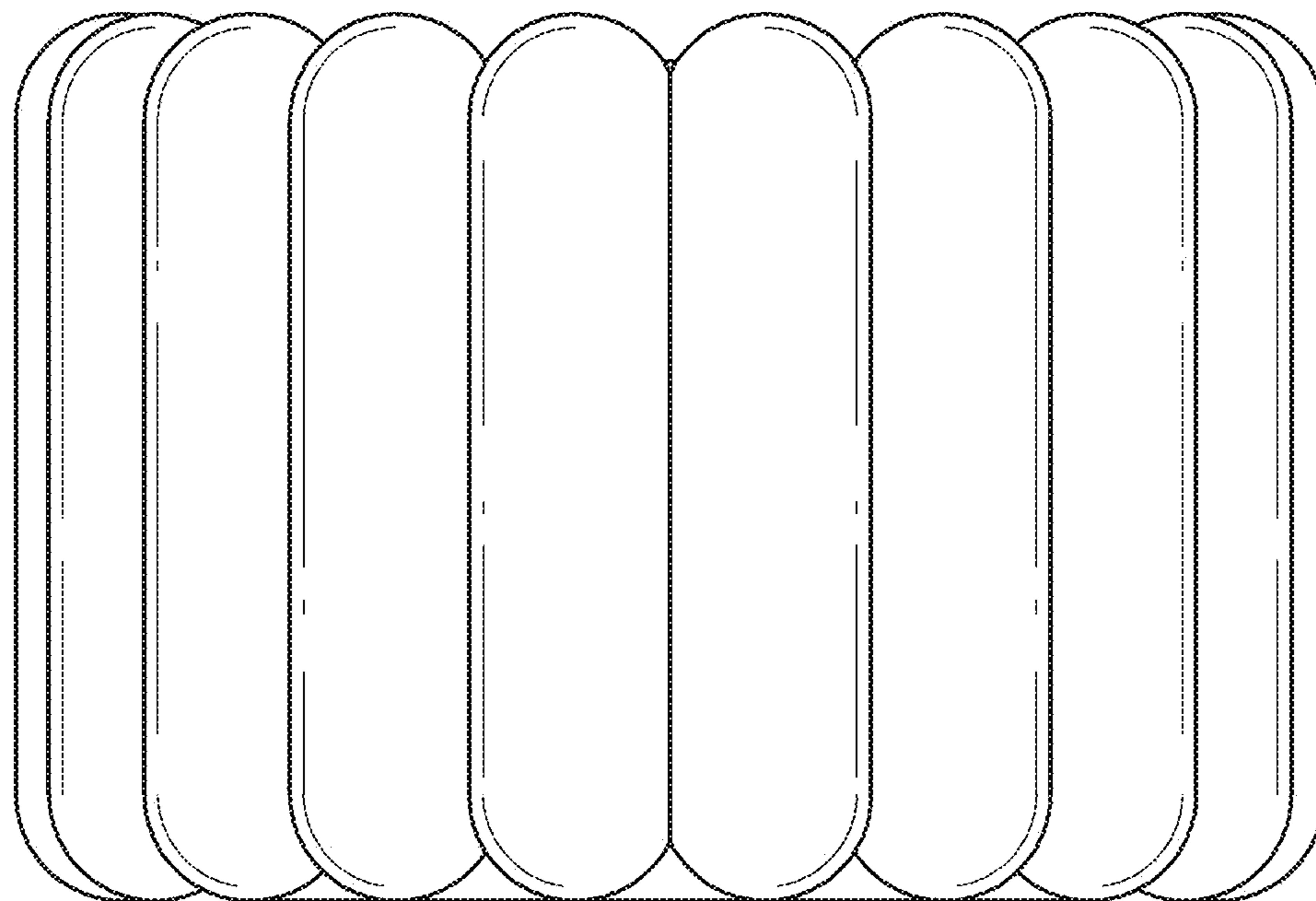

FIG. 22

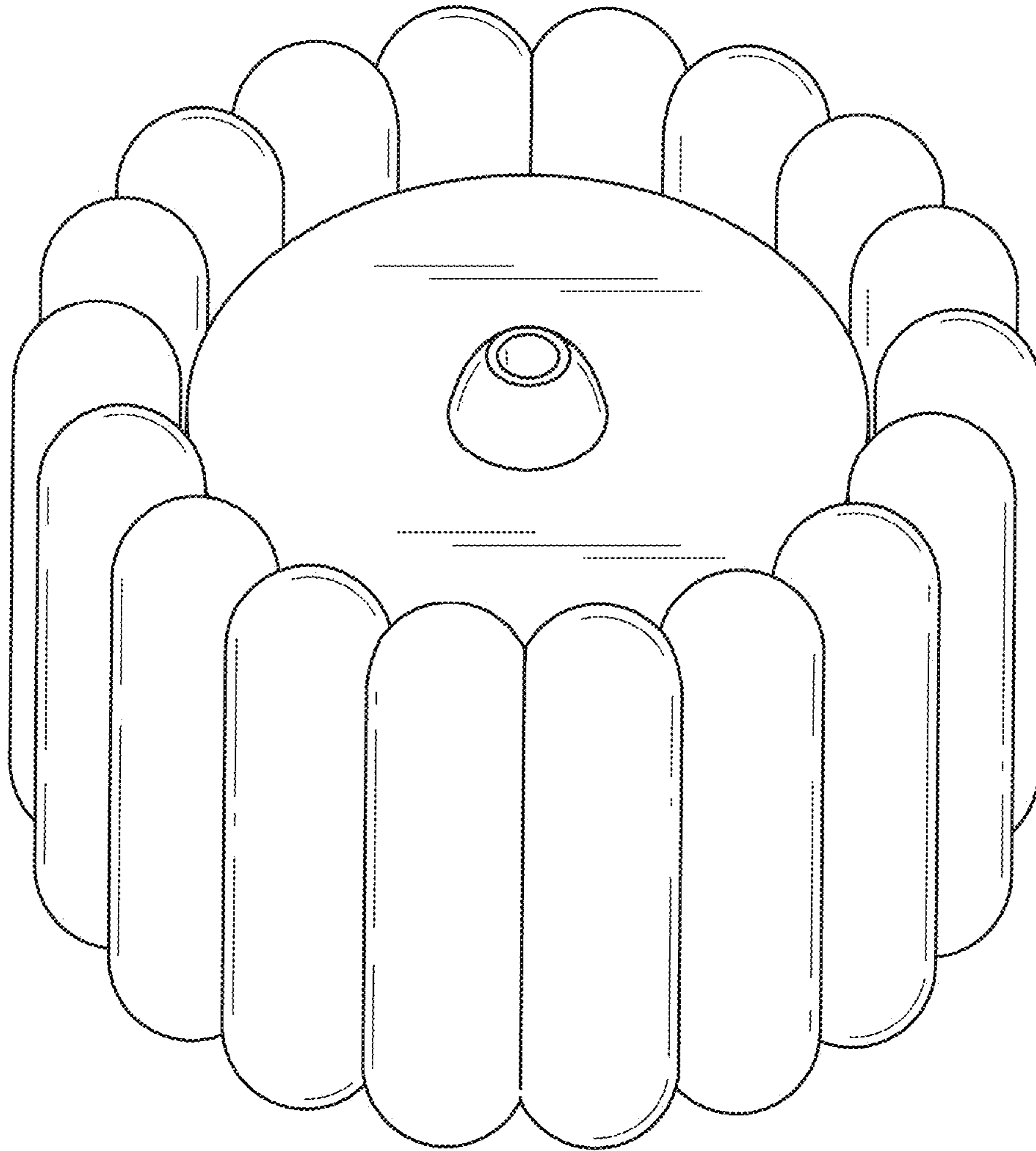

FIG. 23

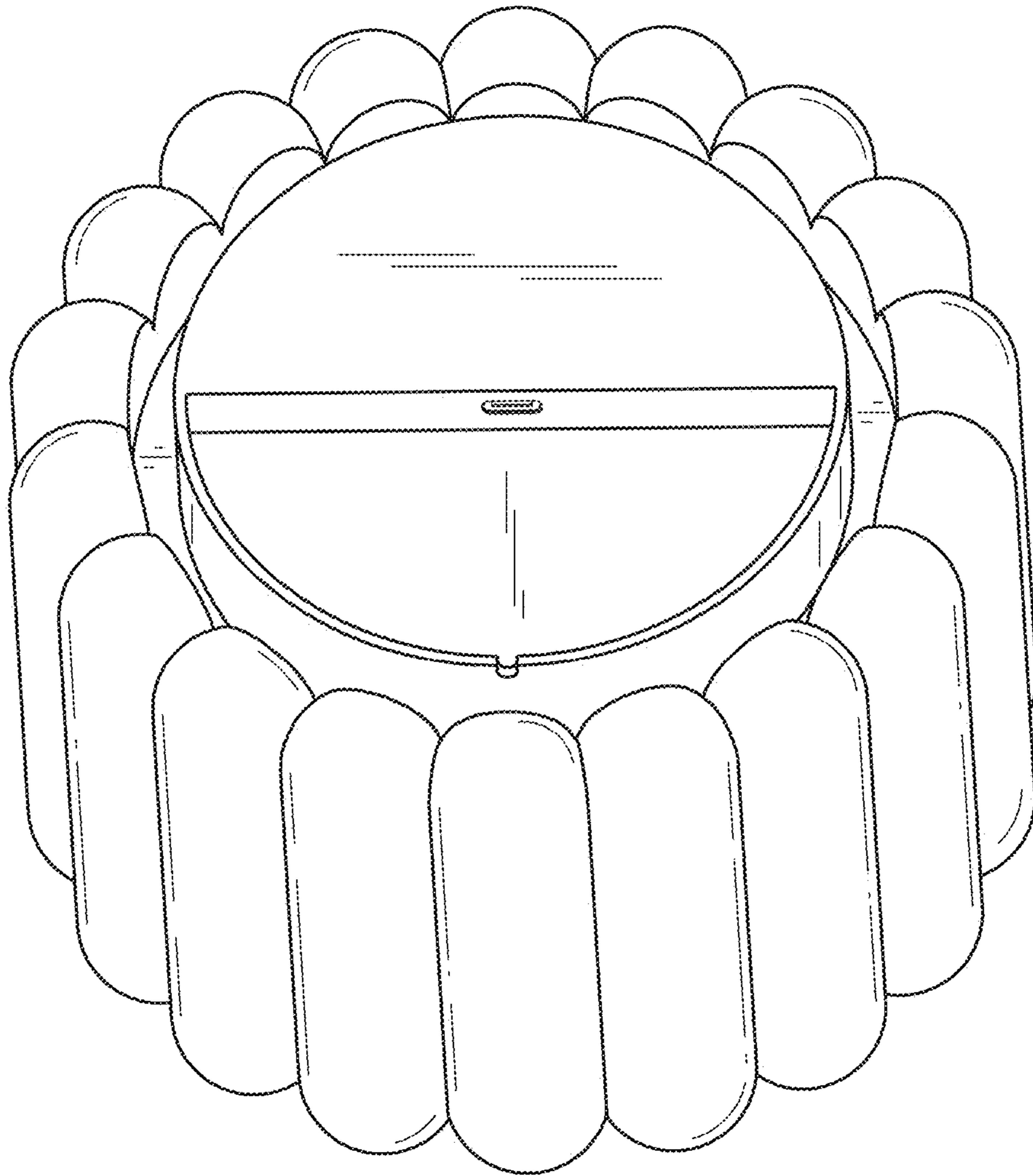

FIG. 24

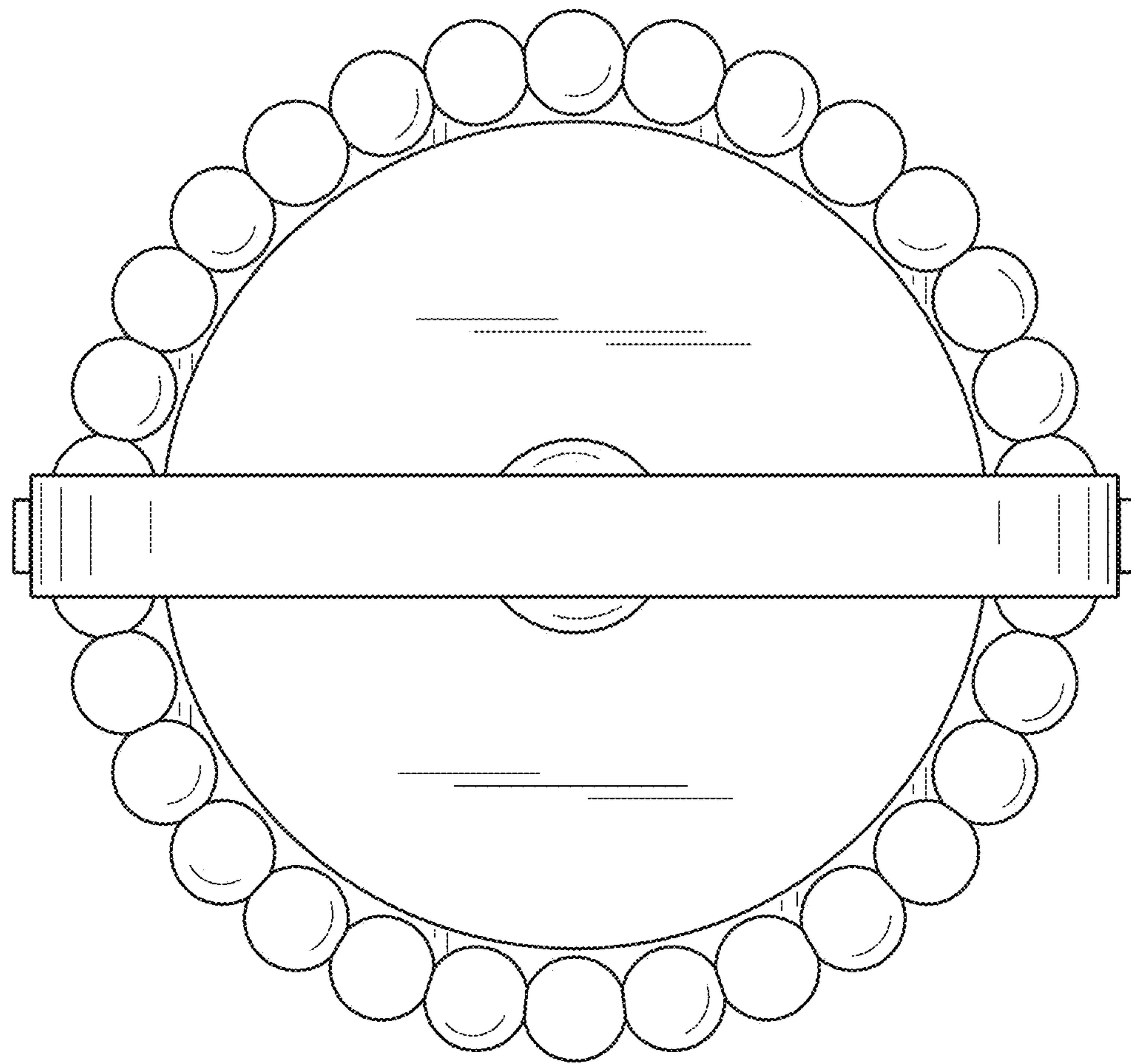

FIG. 25

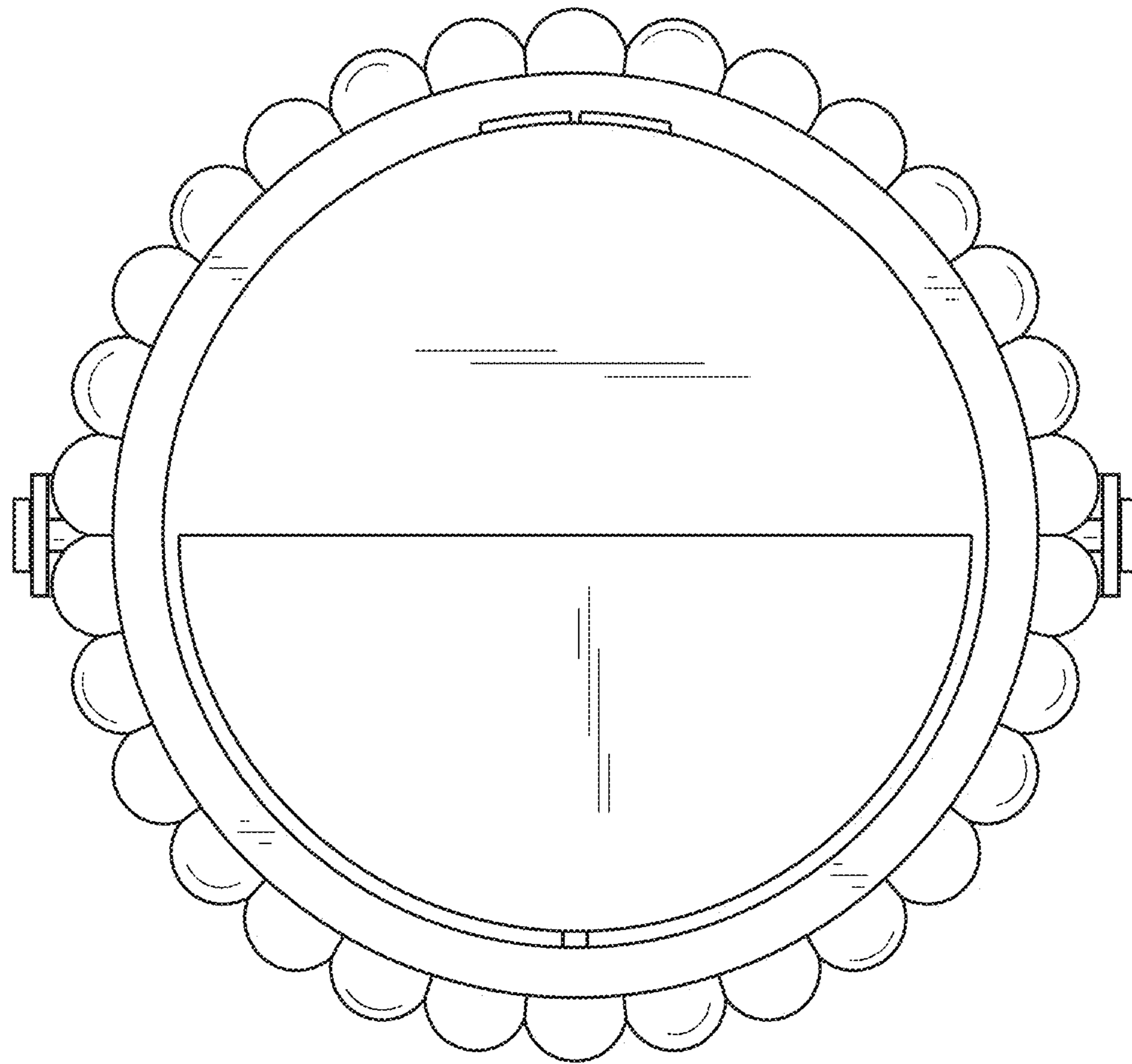

FIG. 26

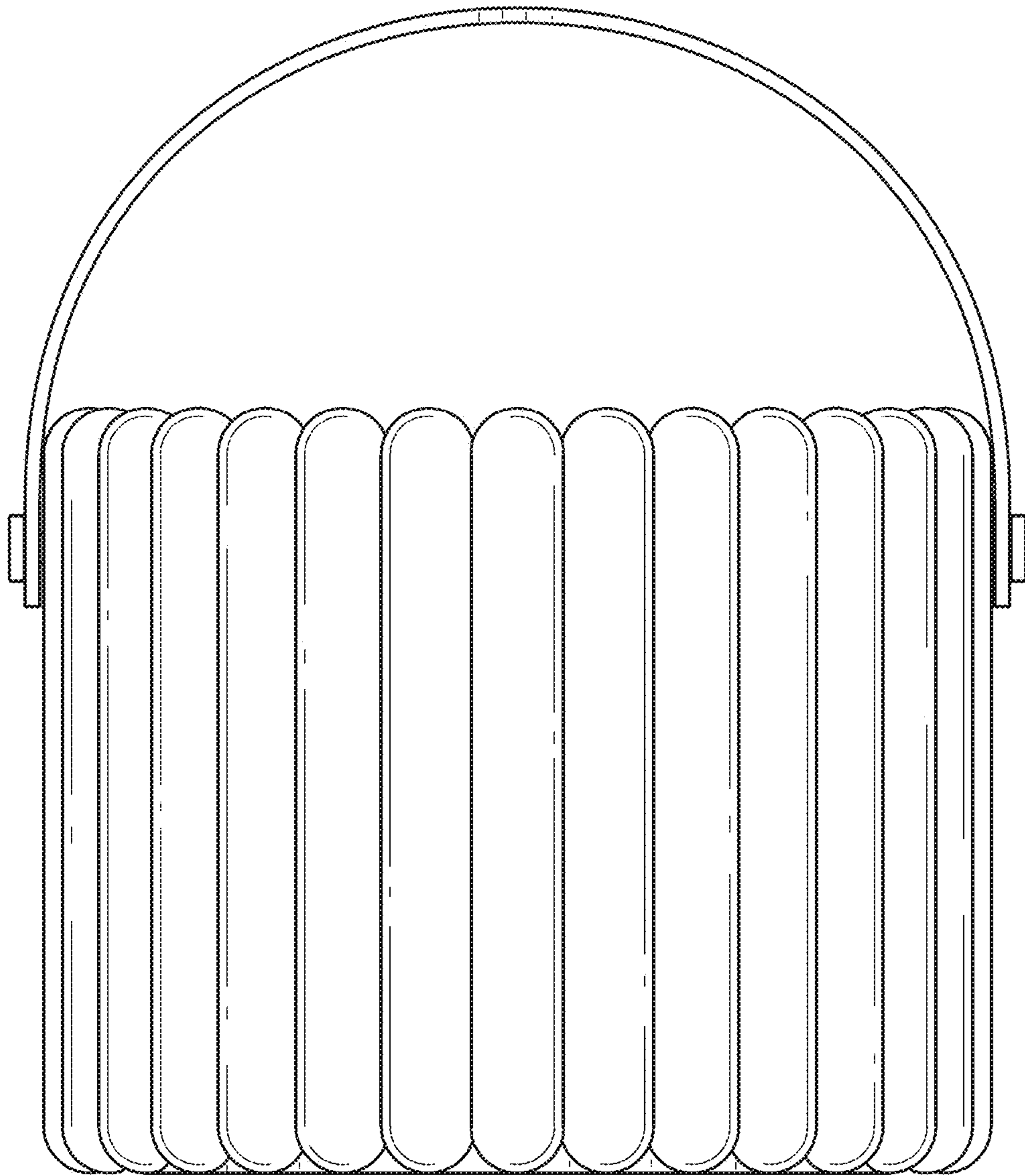

FIG. 27

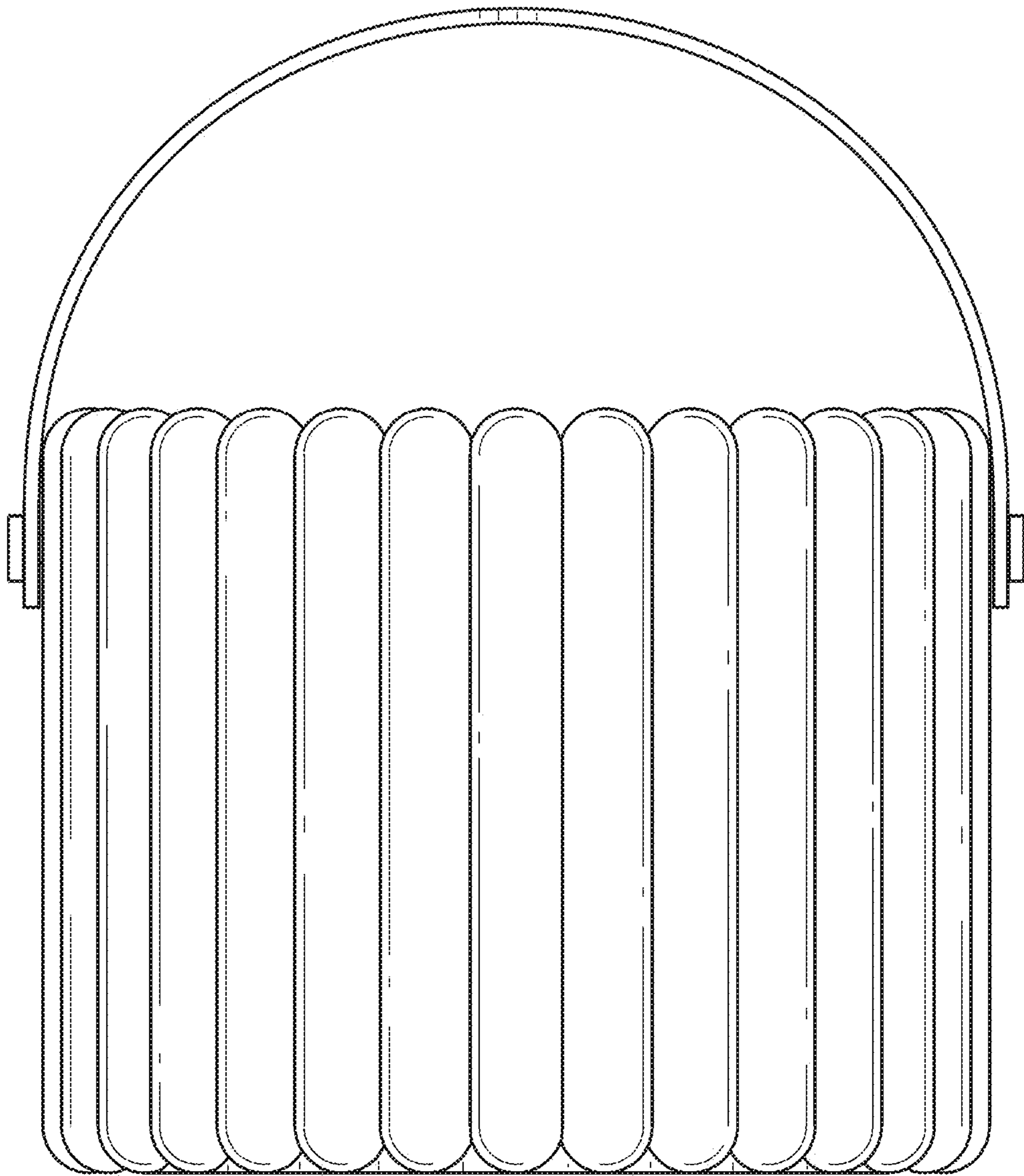

FIG. 28

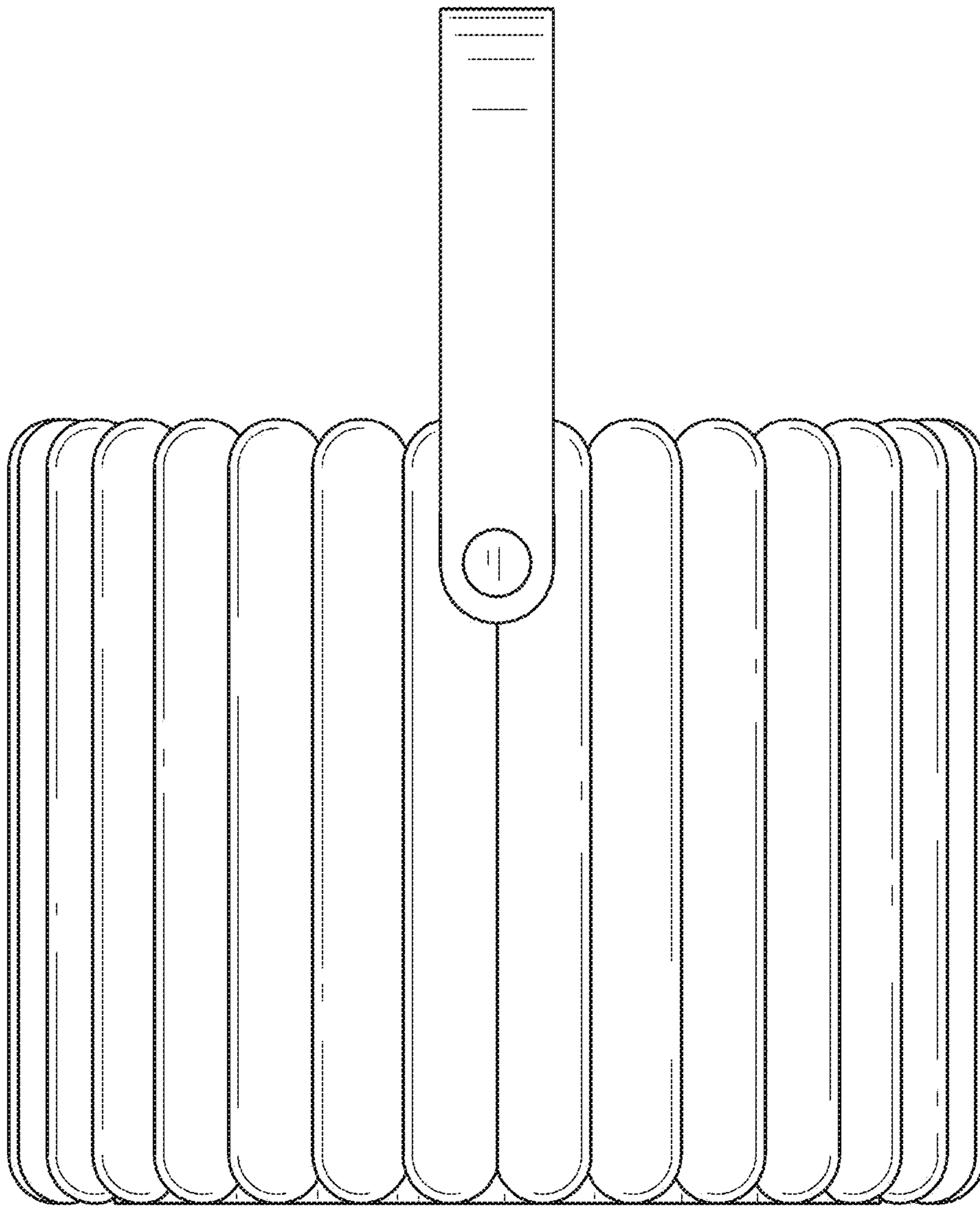

FIG. 29

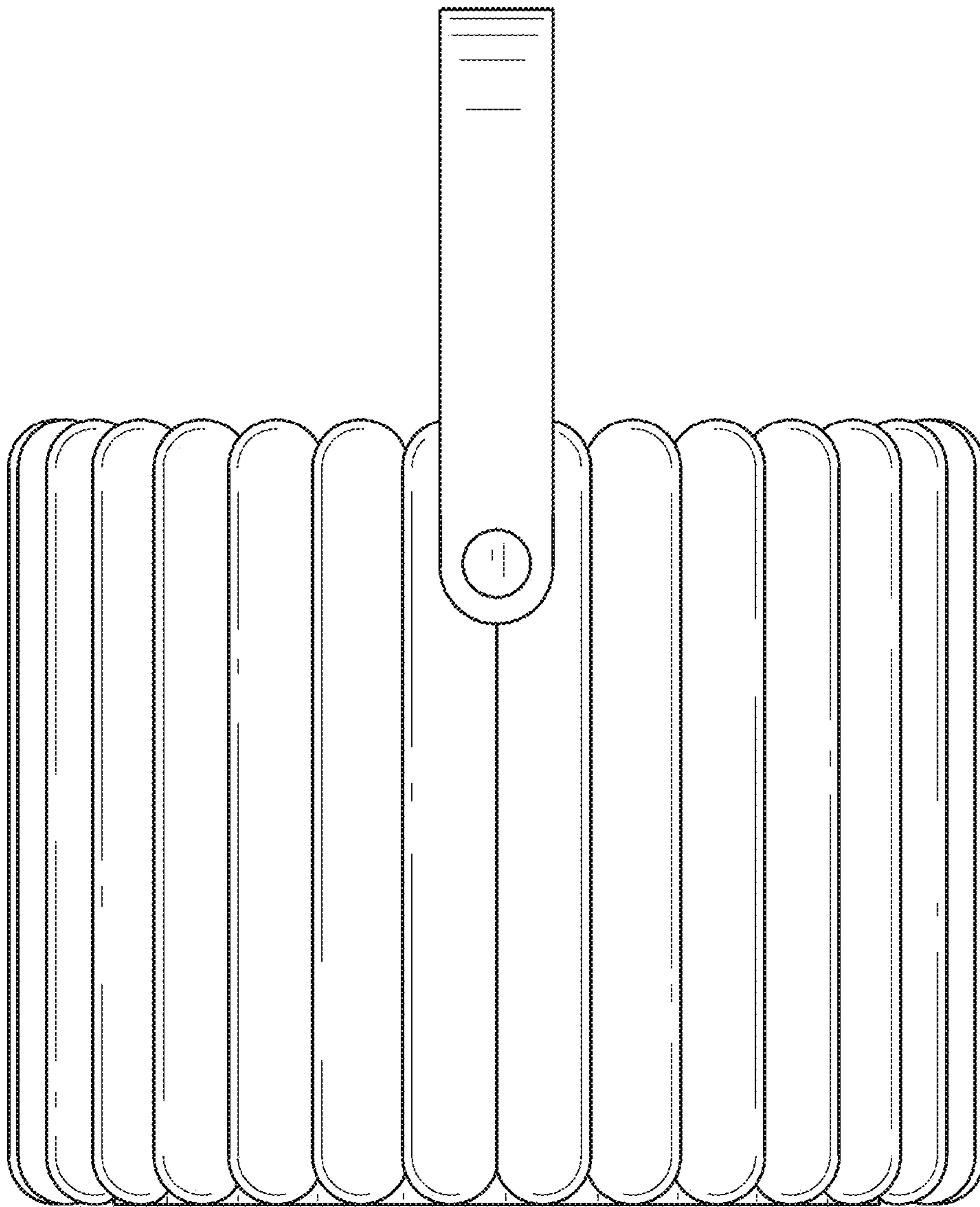

FIG. 30

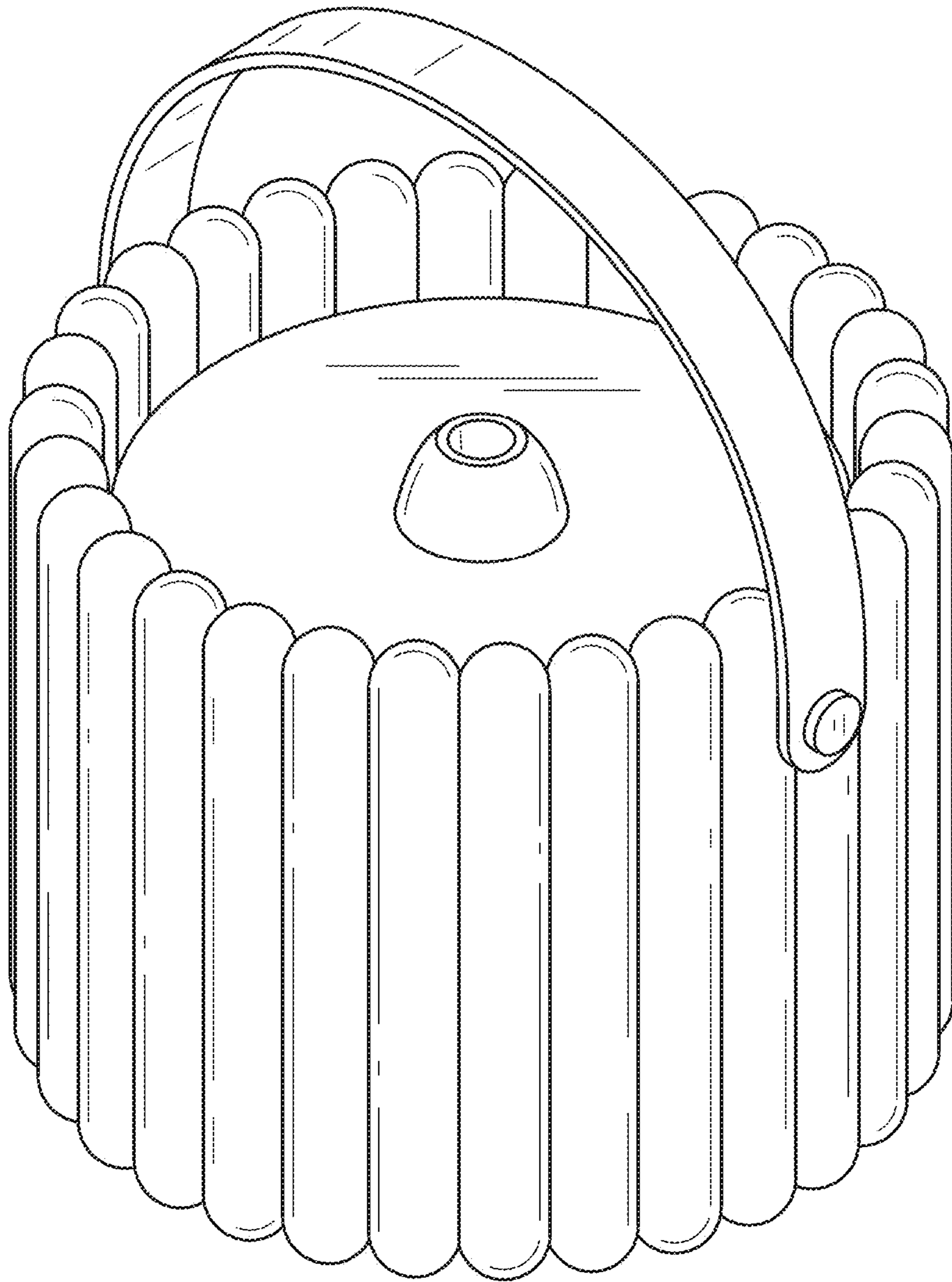

FIG. 31

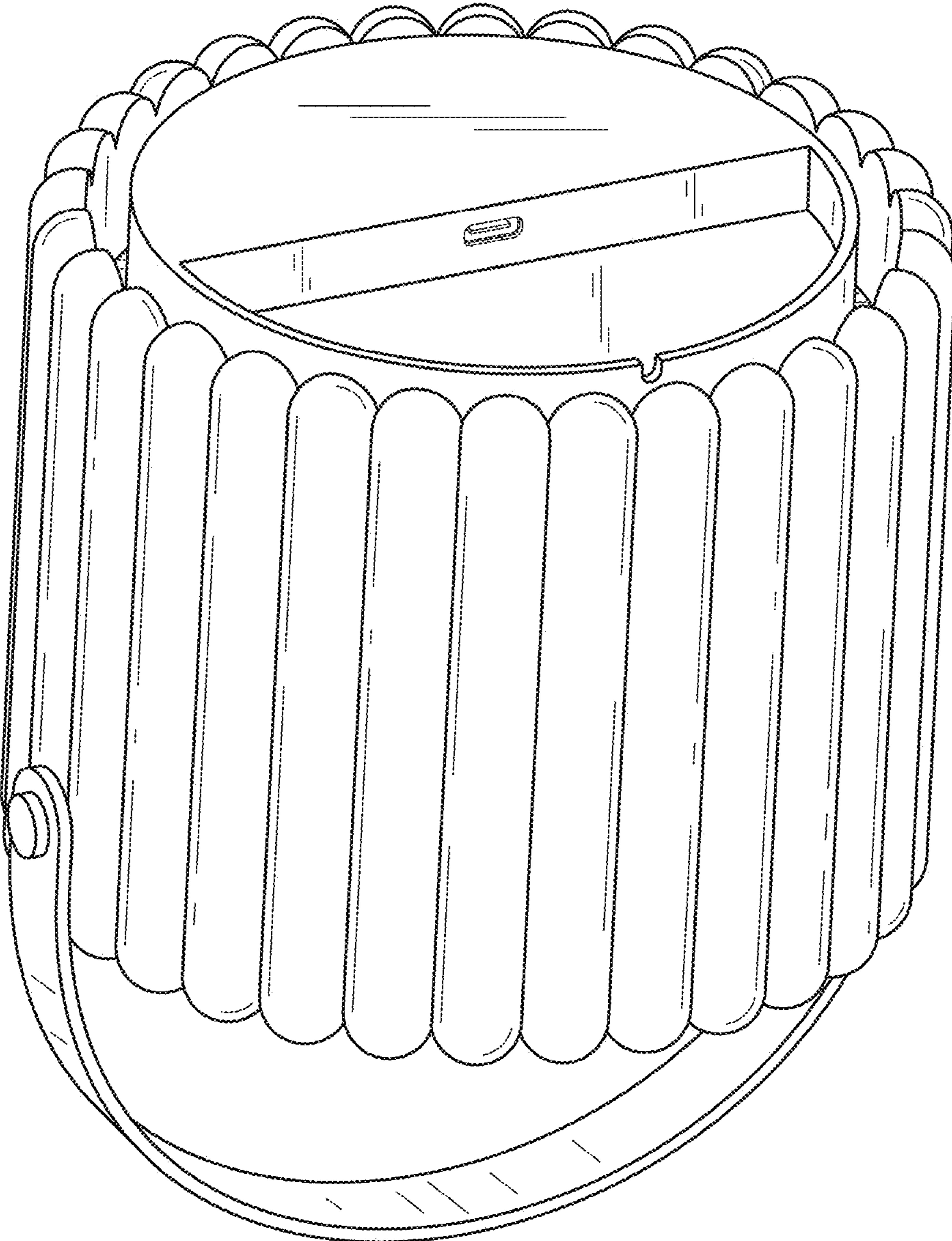

FIG. 32

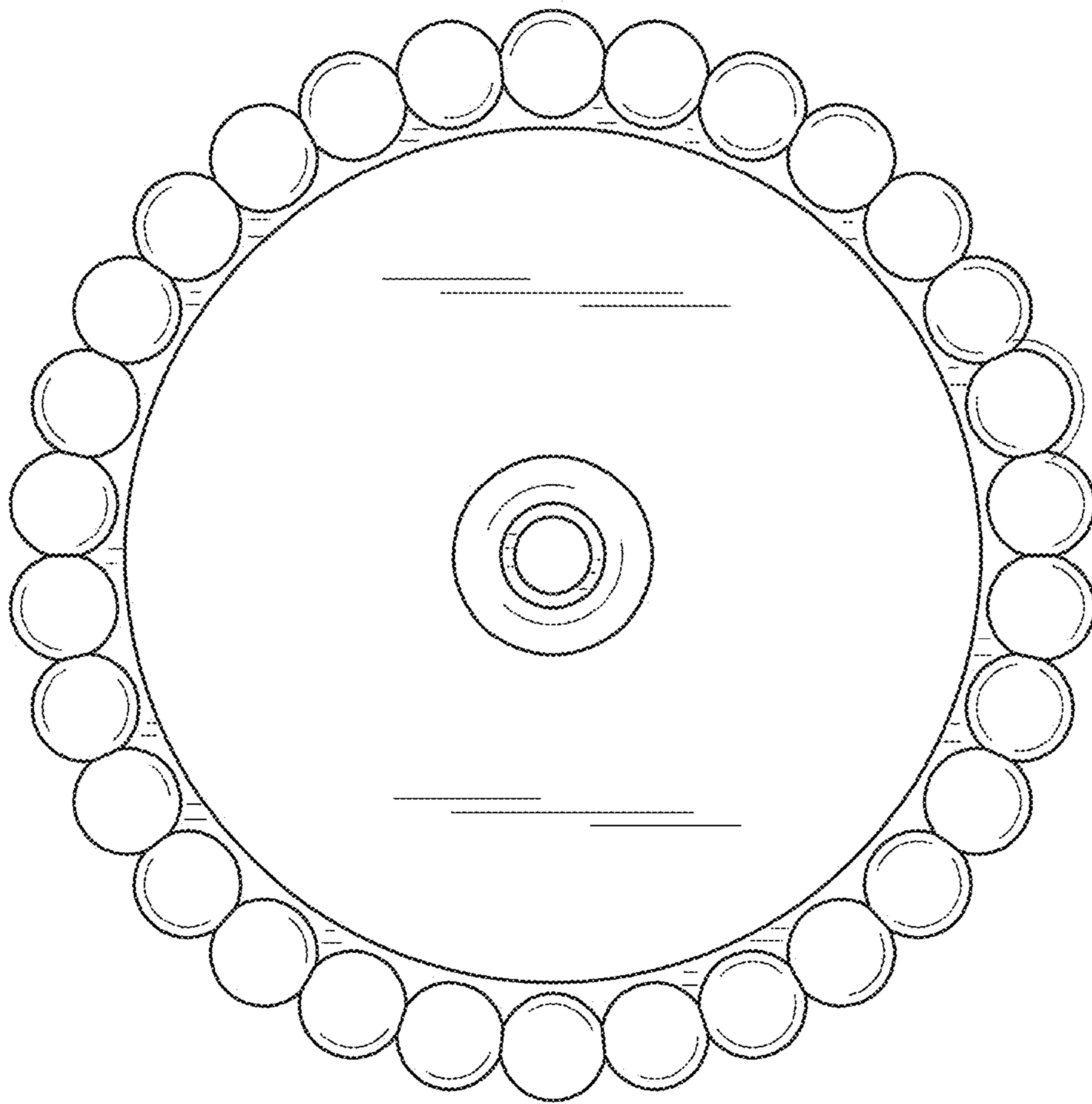

FIG. 33

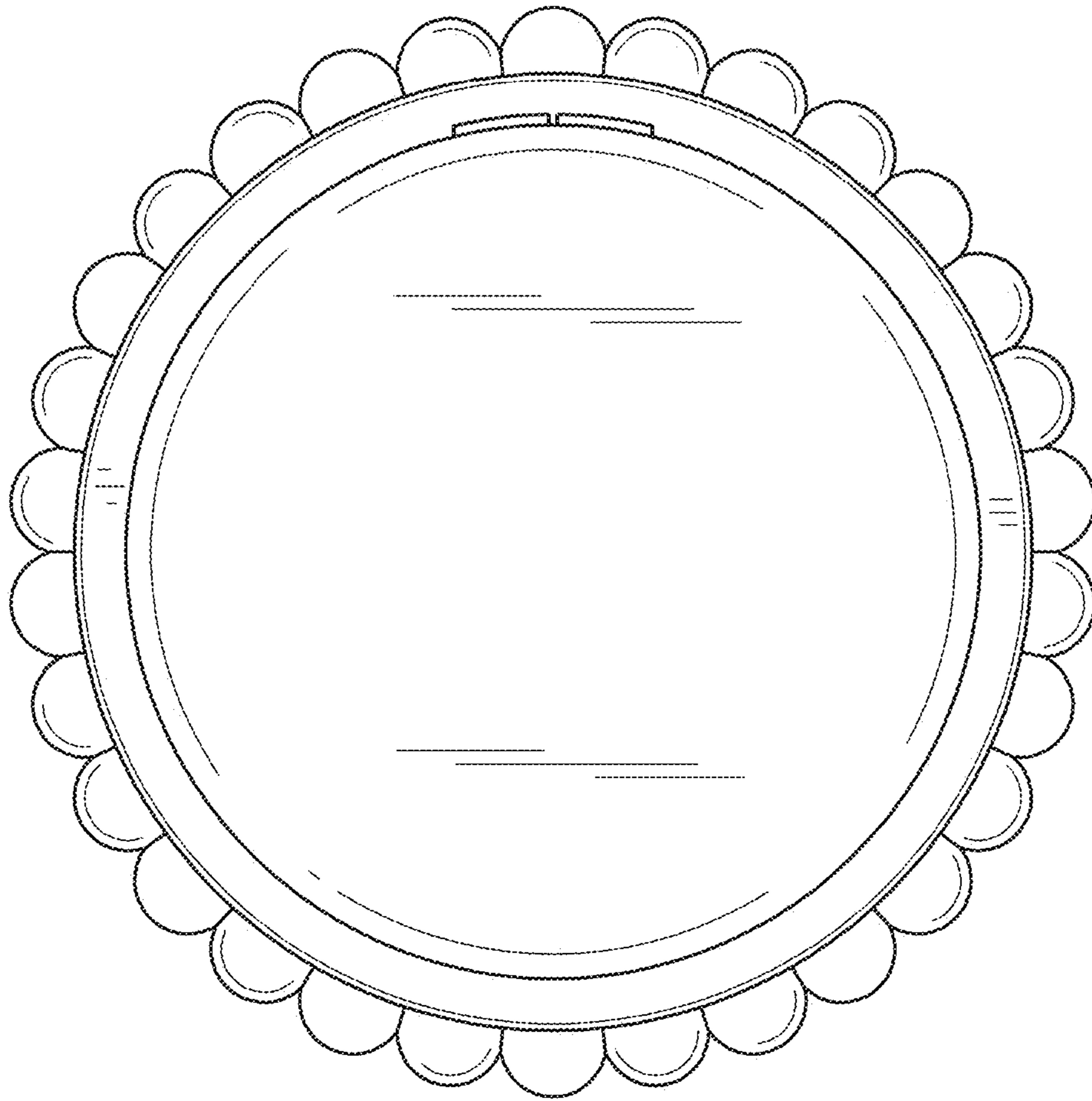

FIG. 34

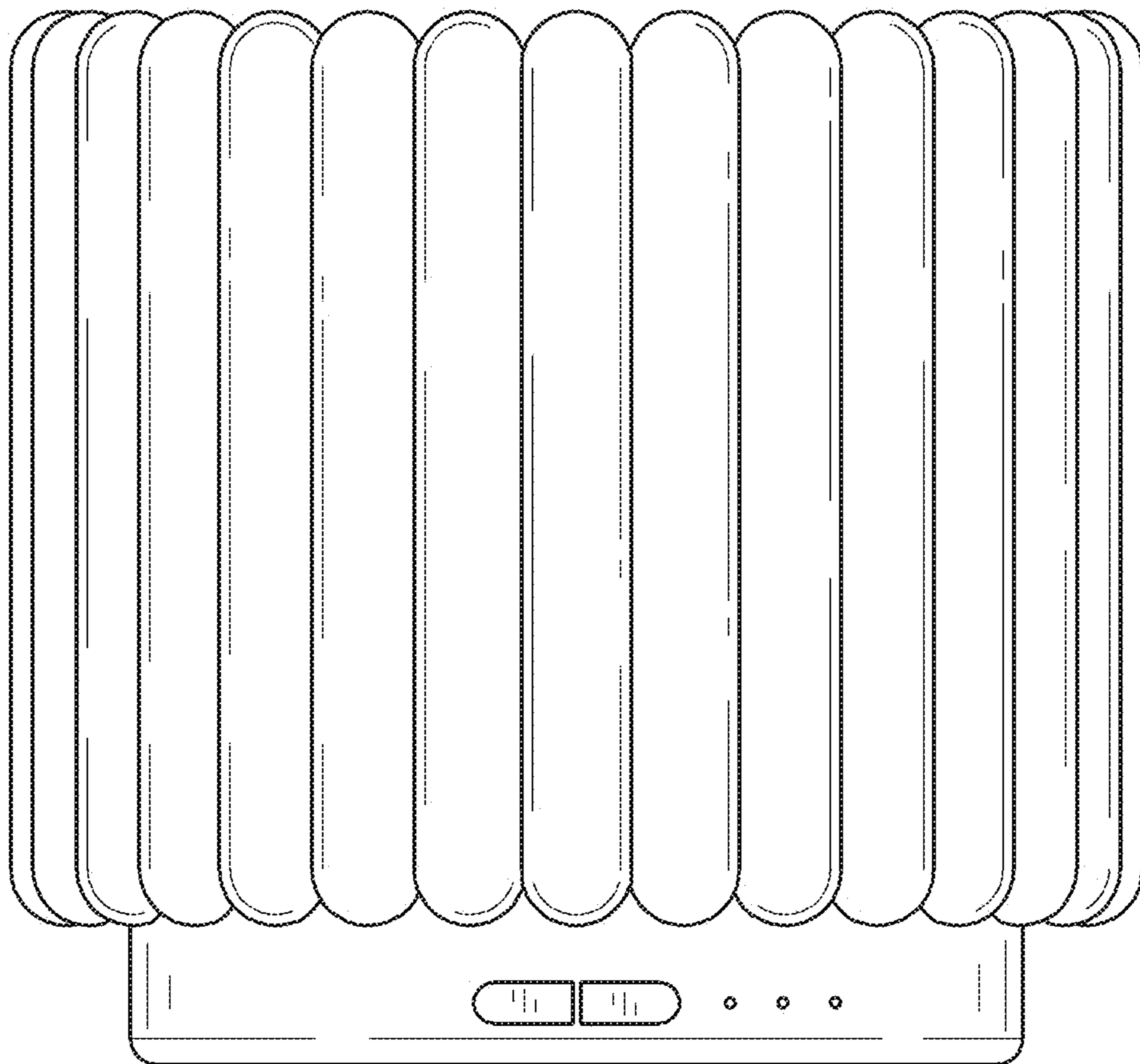

FIG. 35

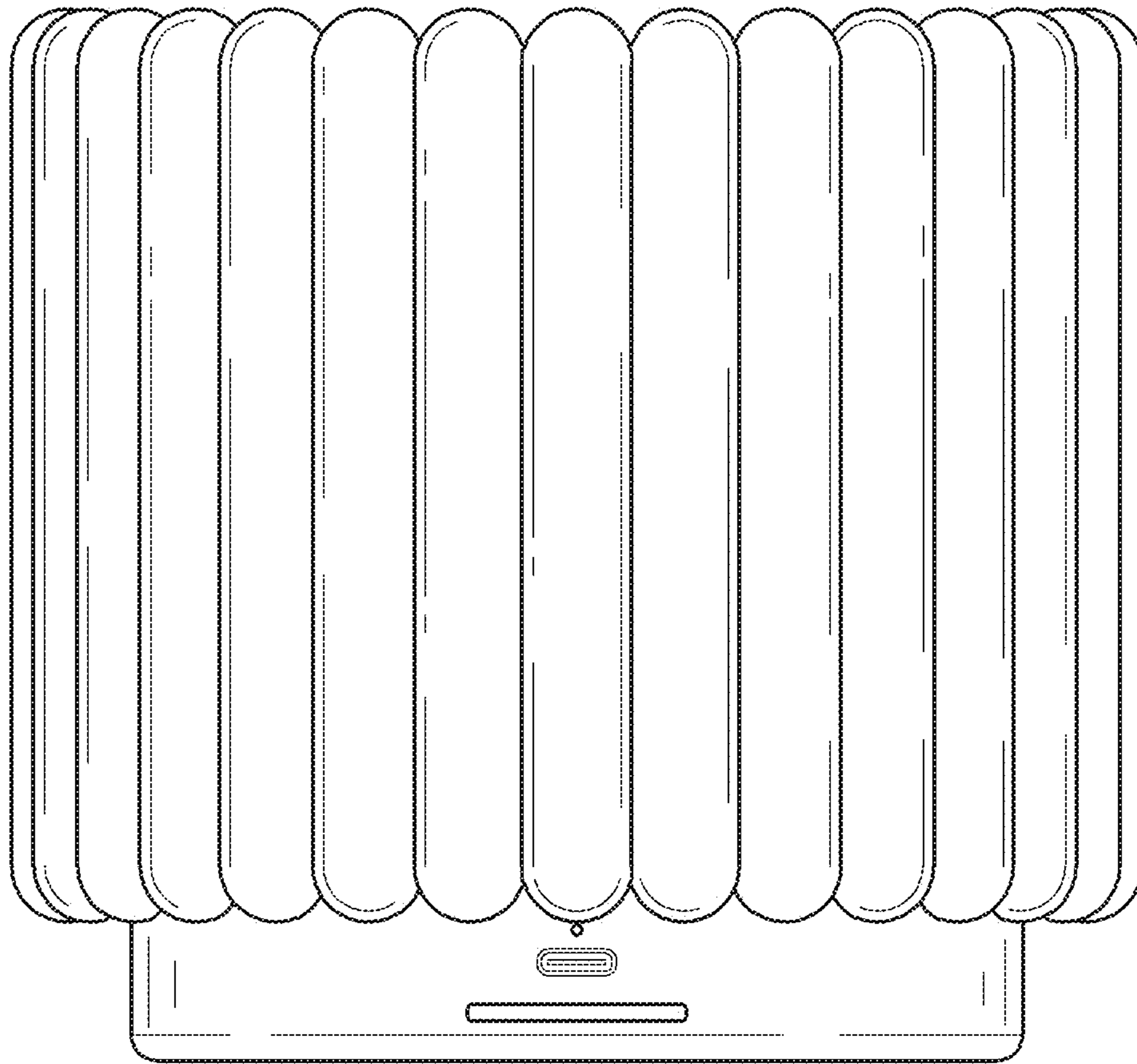

FIG. 36

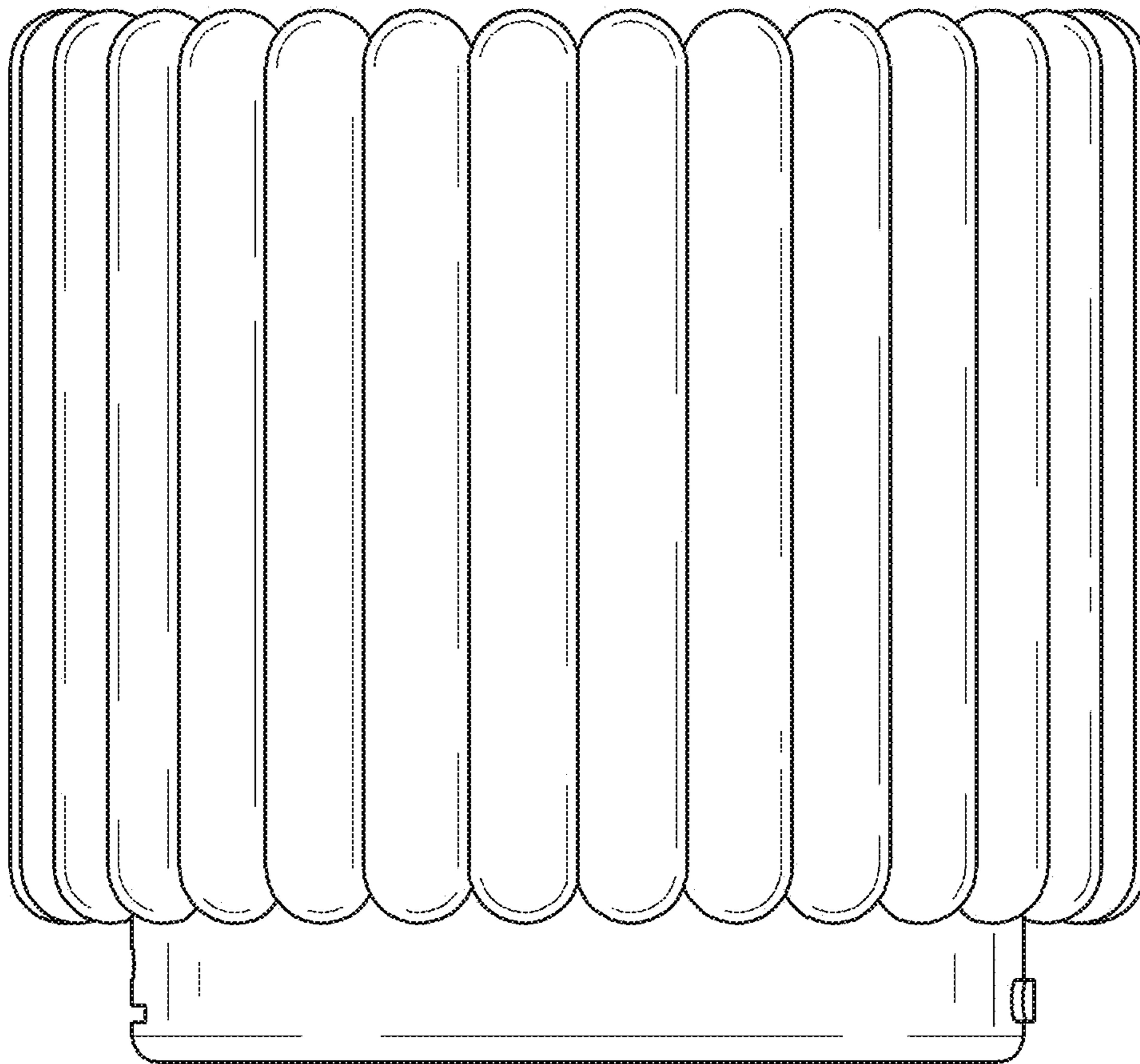

FIG. 37

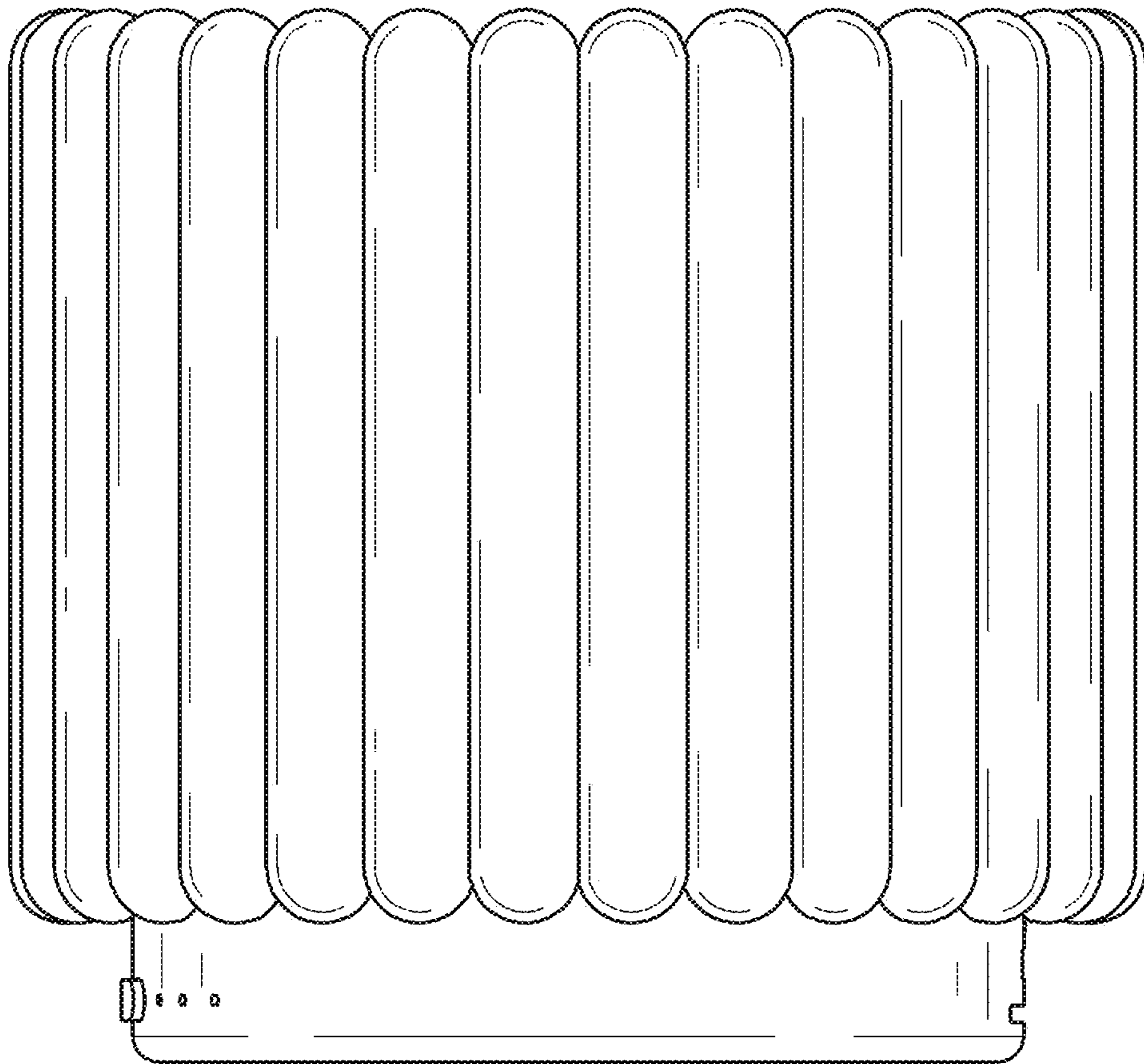

FIG. 38

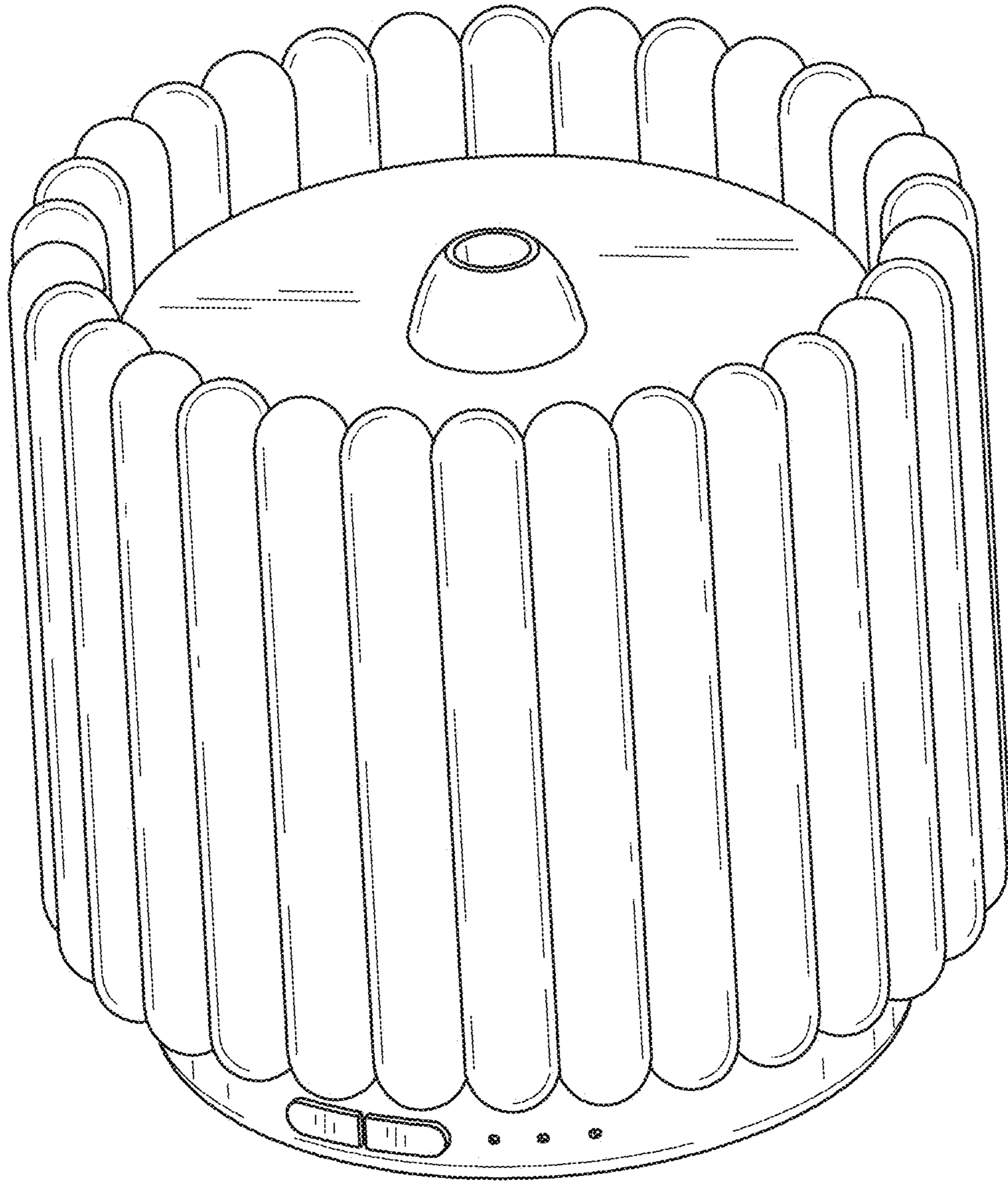

FIG. 39

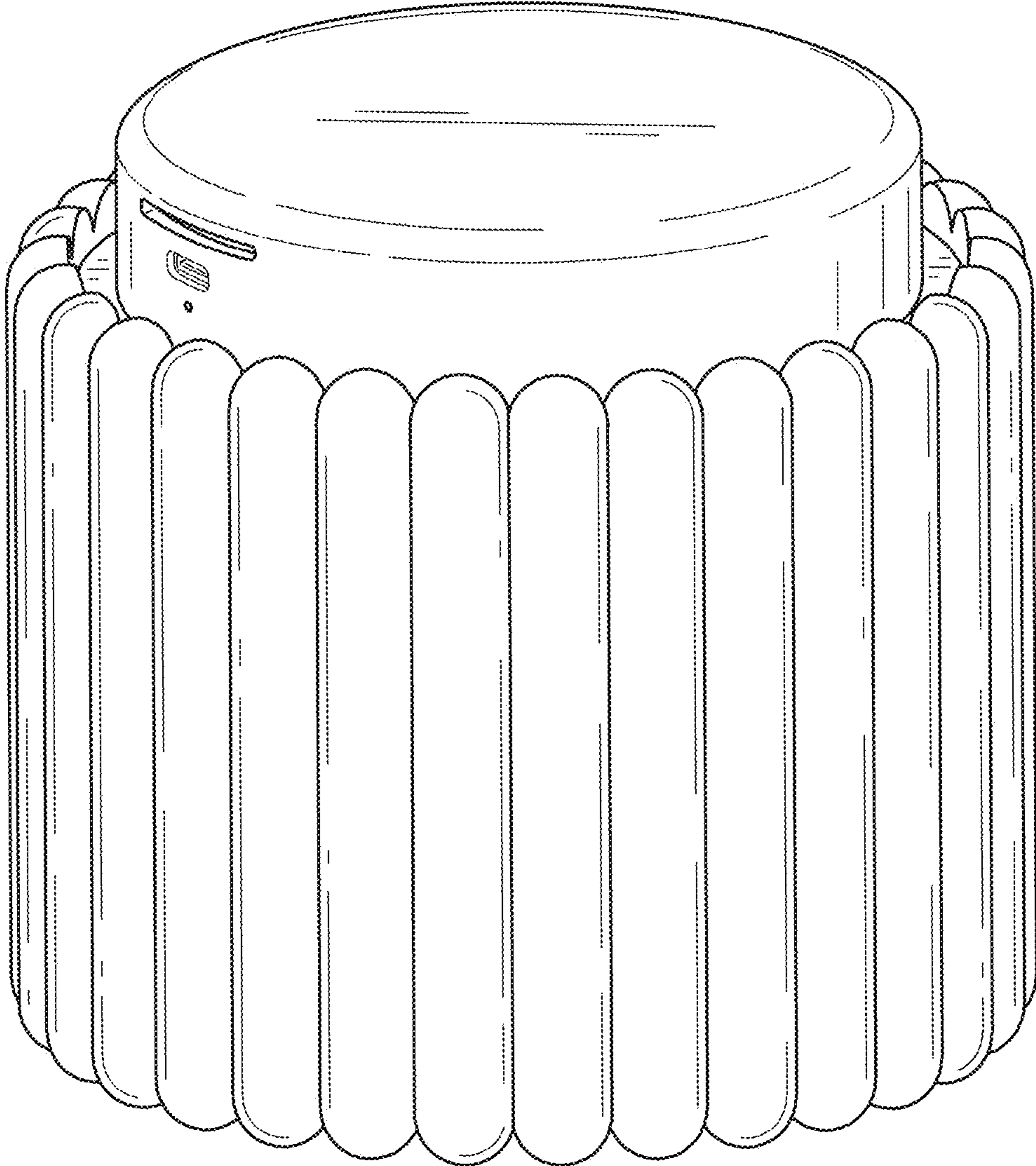

FIG. 40

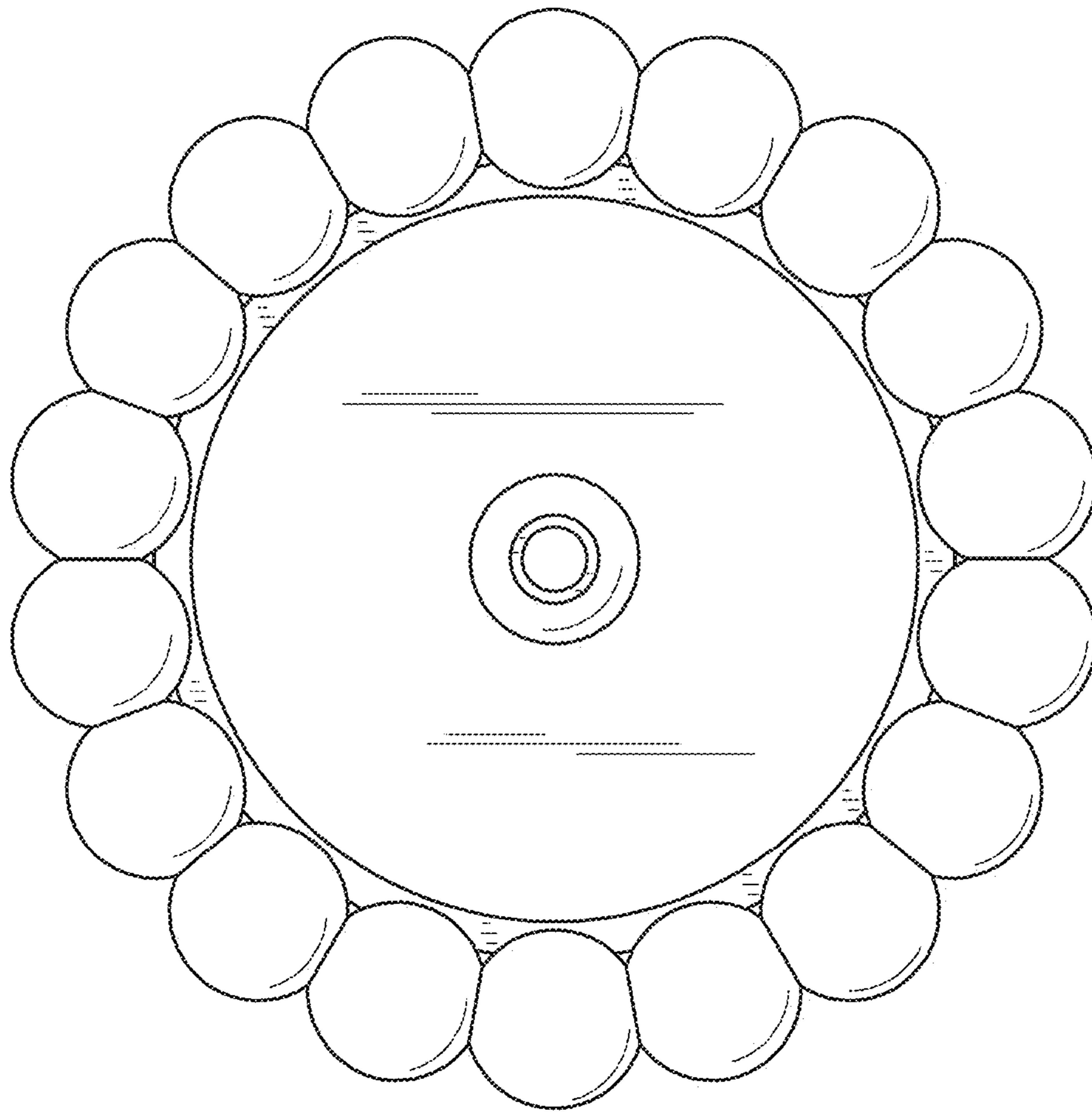

FIG. 41

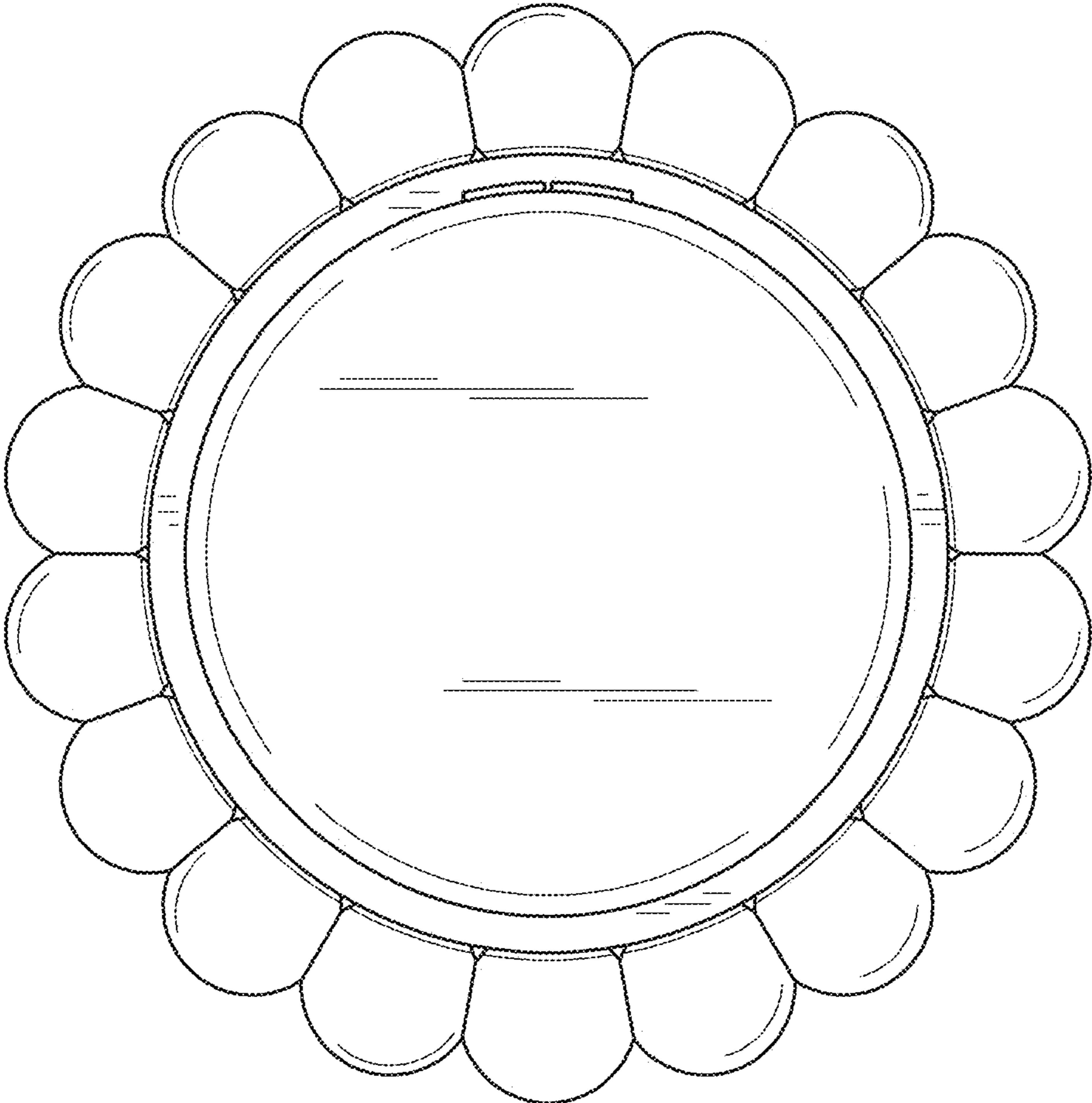

FIG. 42

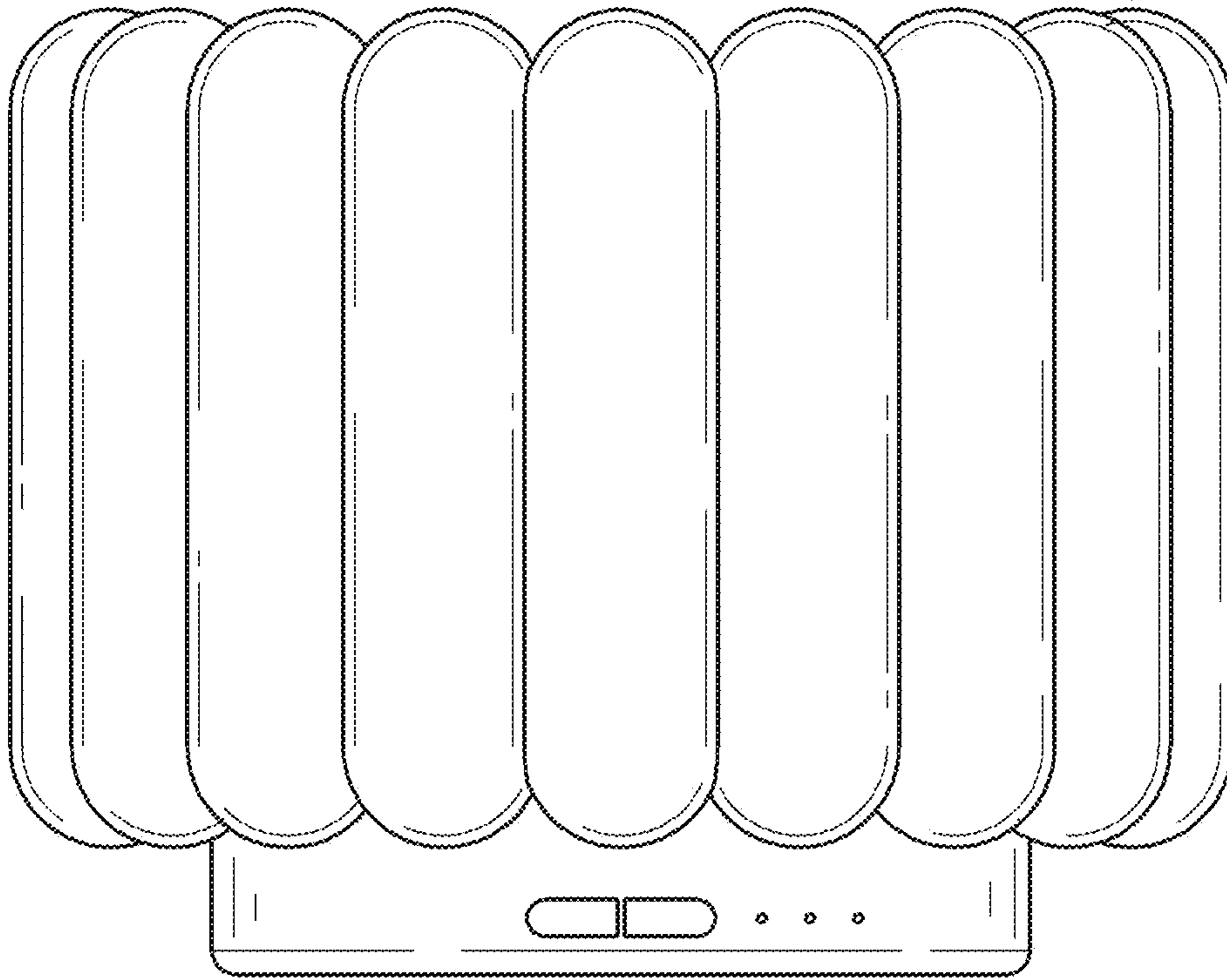

FIG. 43

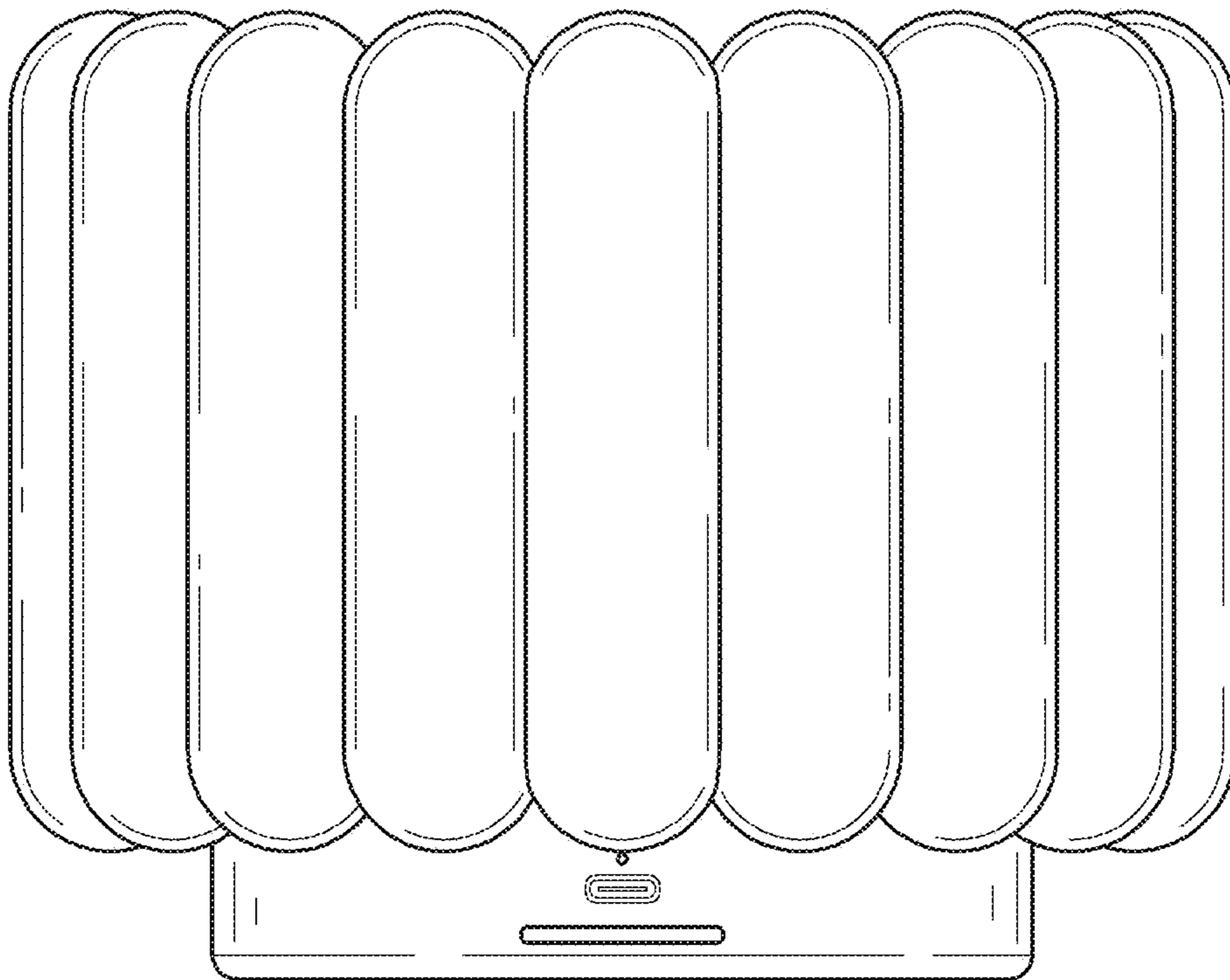

FIG. 44

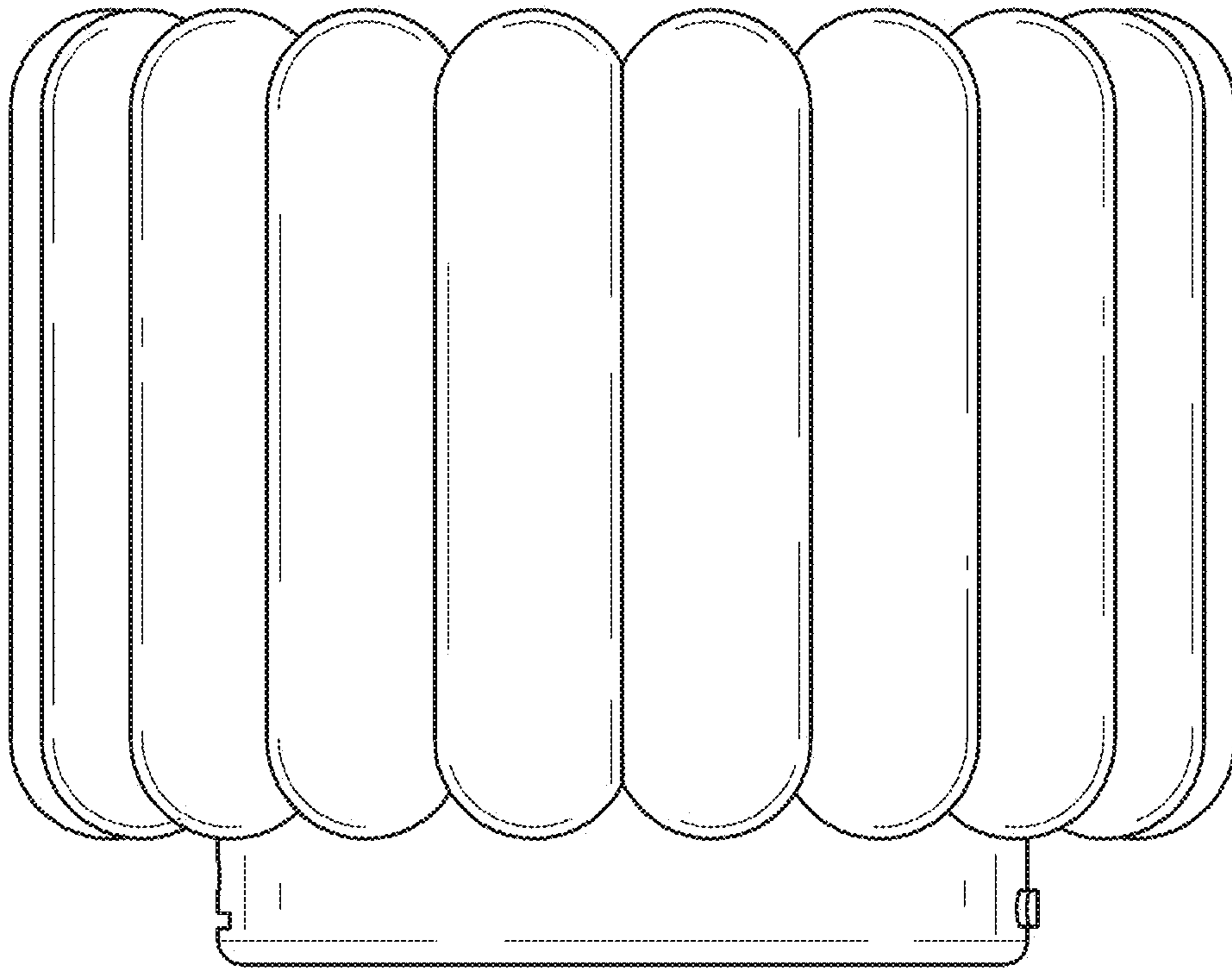

FIG. 45

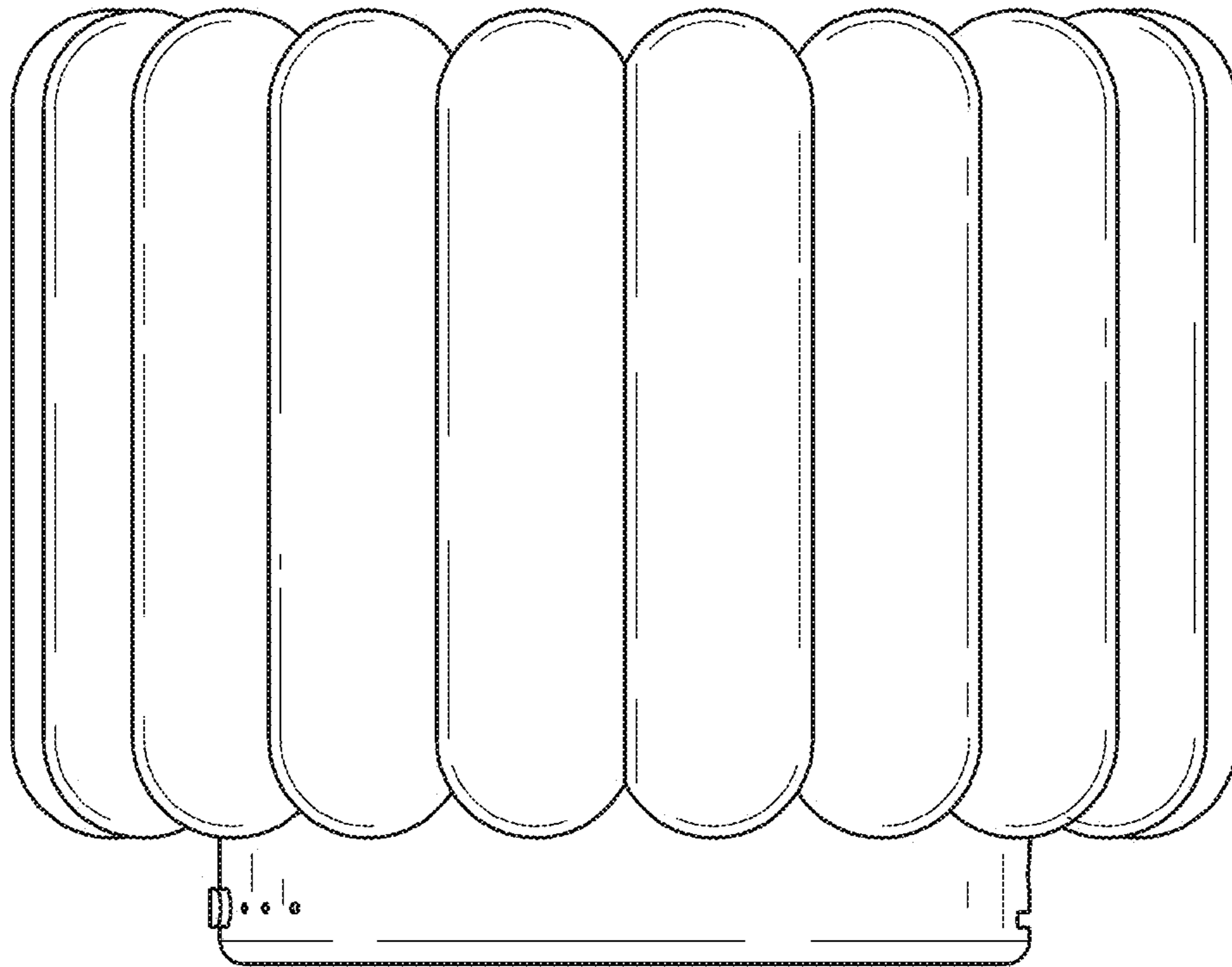

FIG. 46

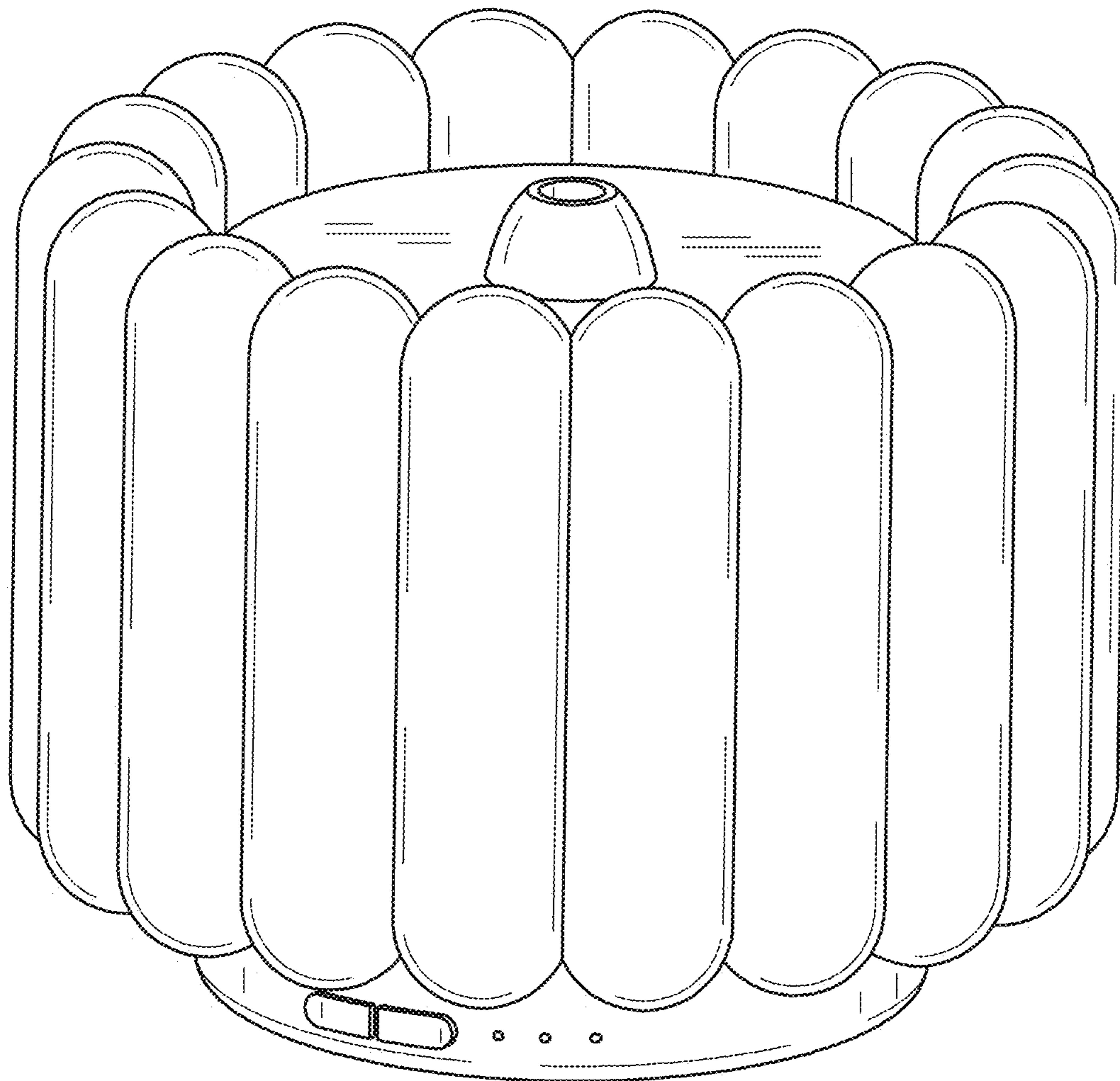

FIG. 47

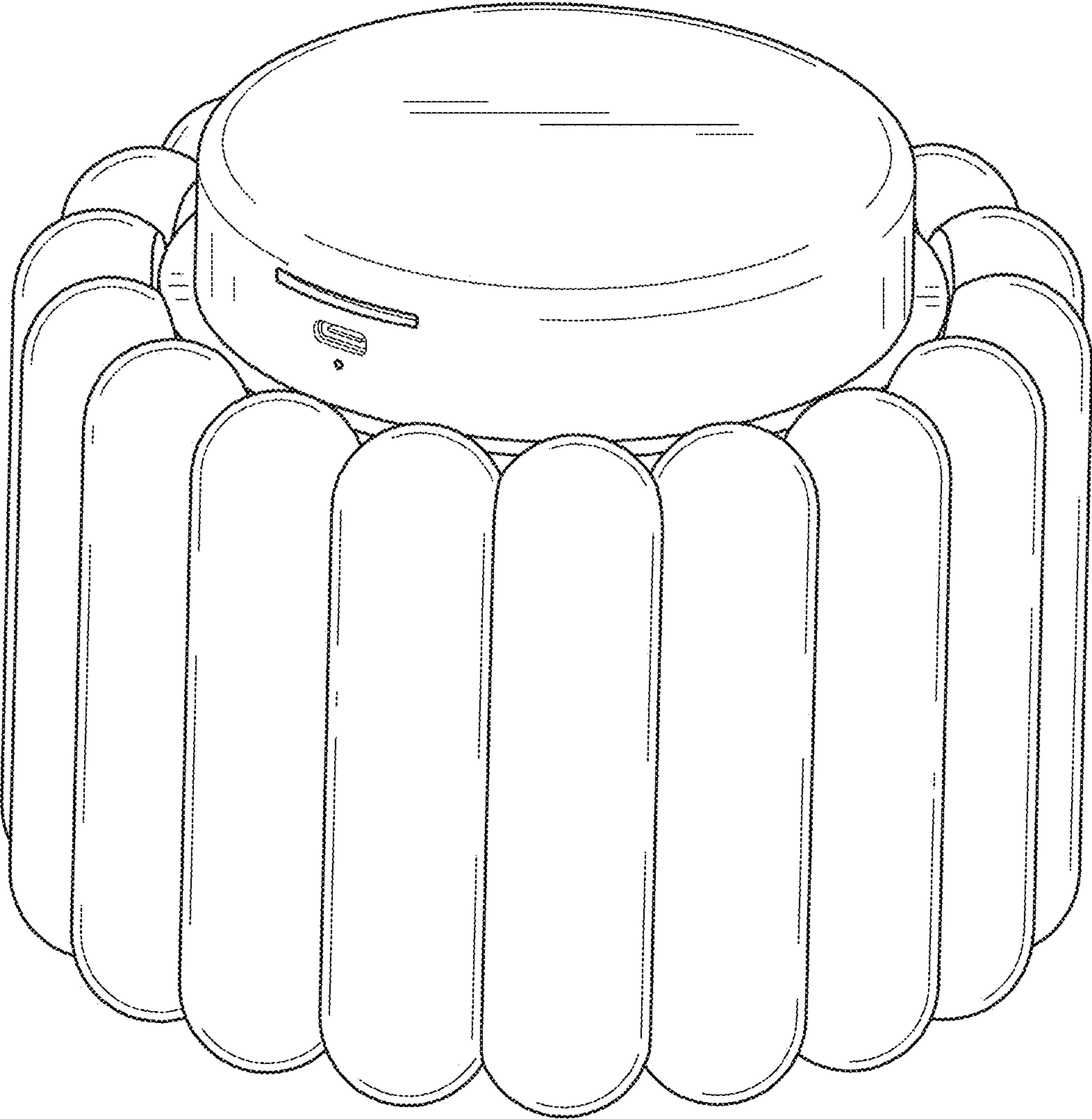

FIG. 48

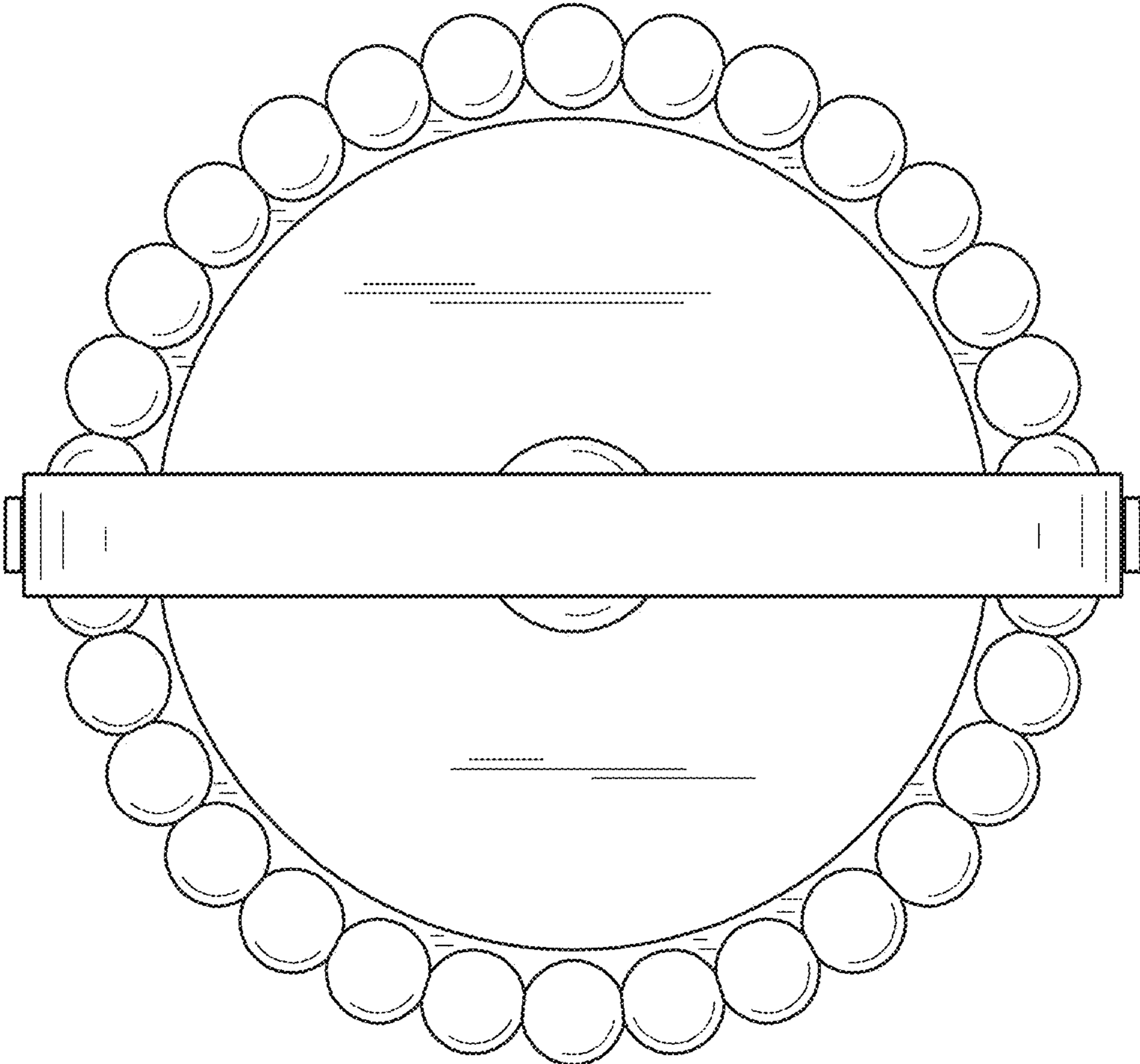

FIG. 49

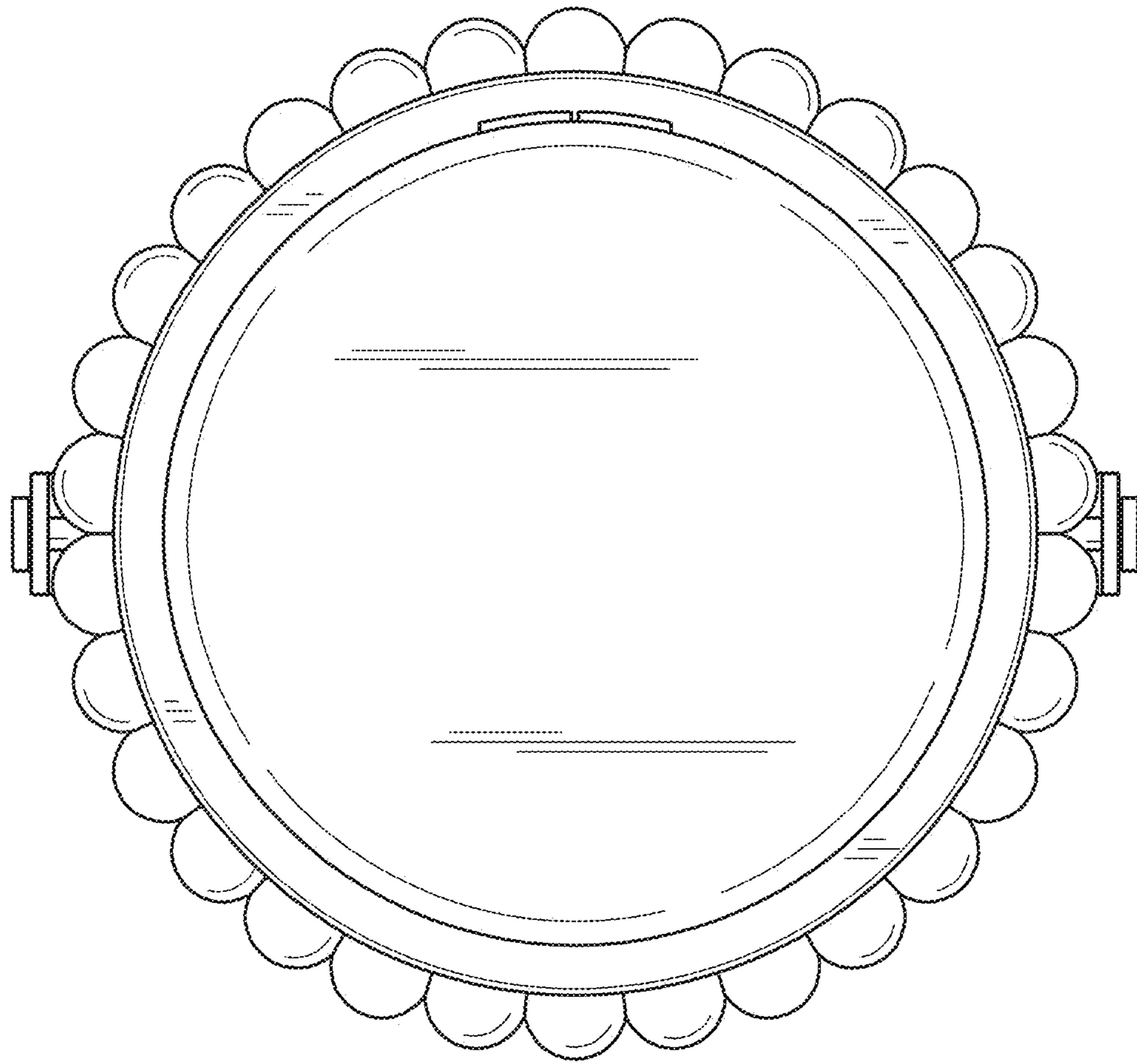

FIG. 50

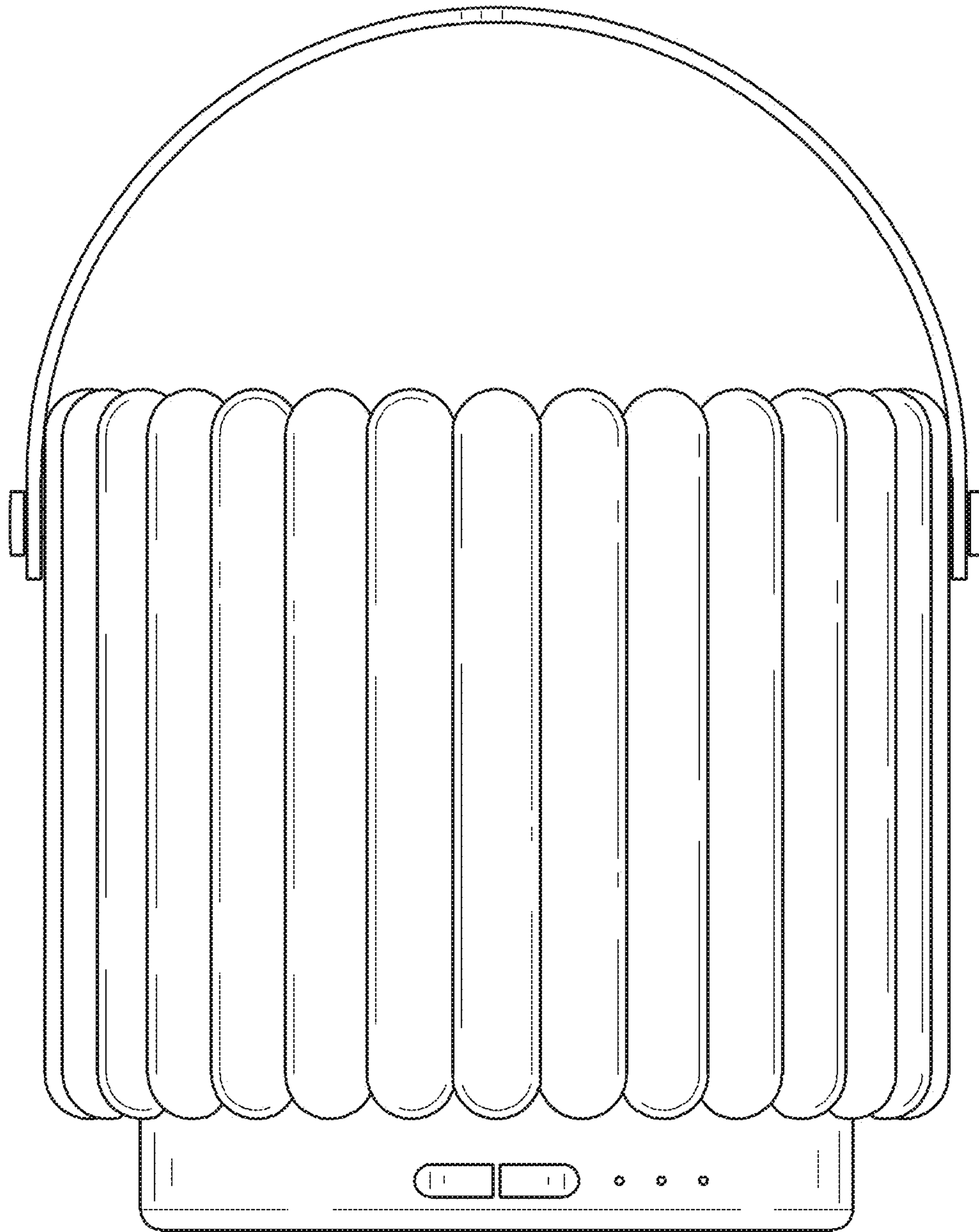

FIG. 51

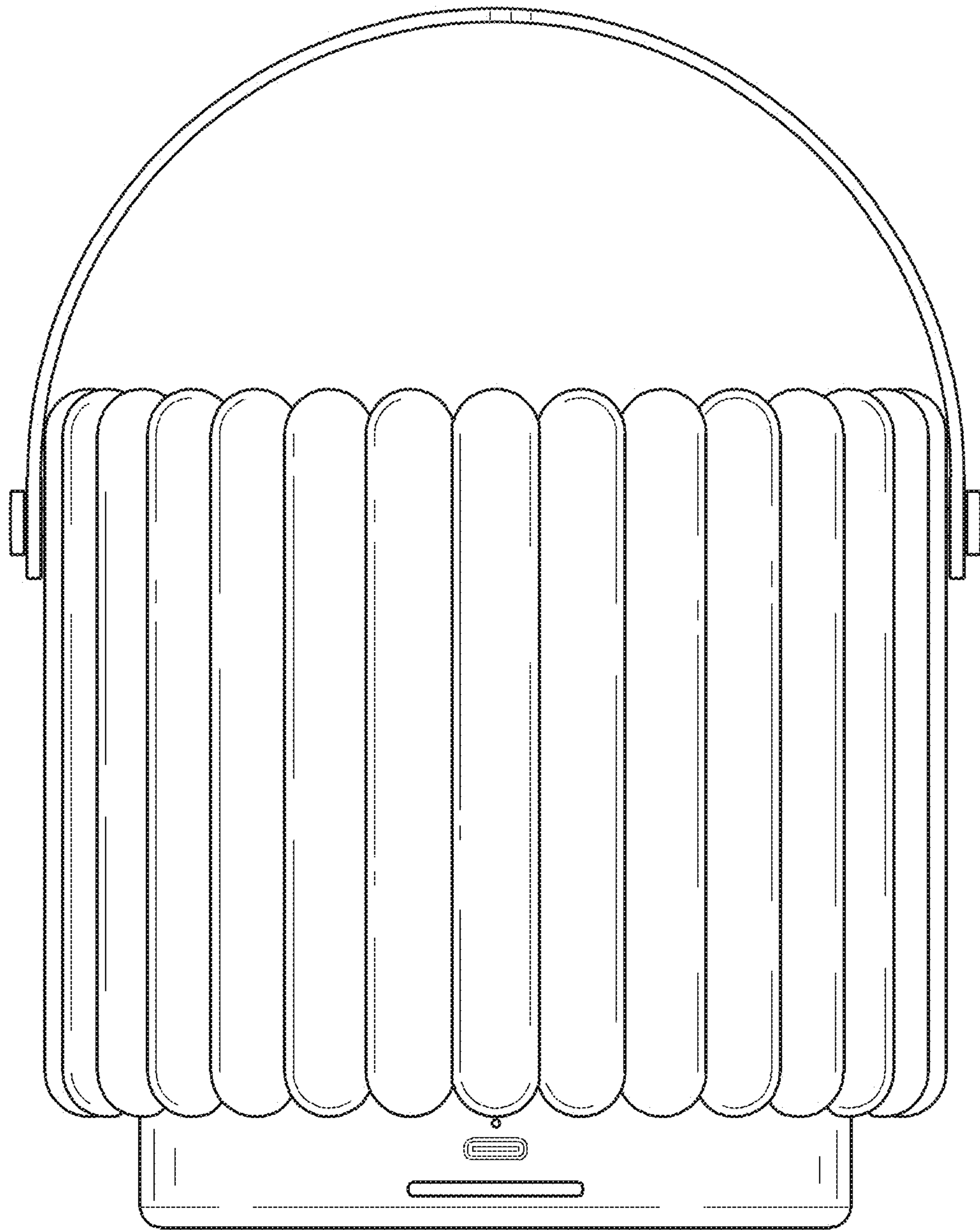

FIG. 52

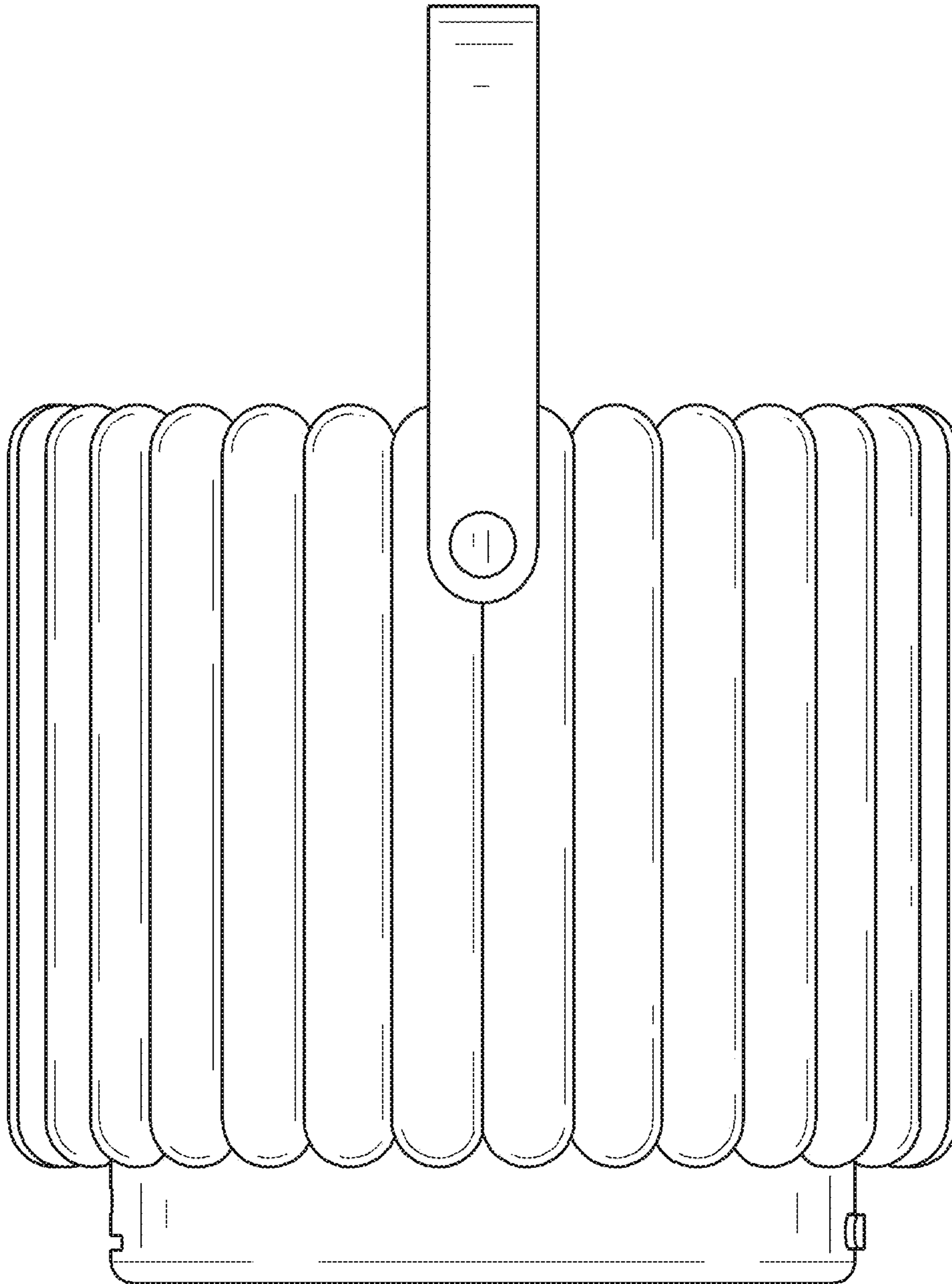

FIG. 53

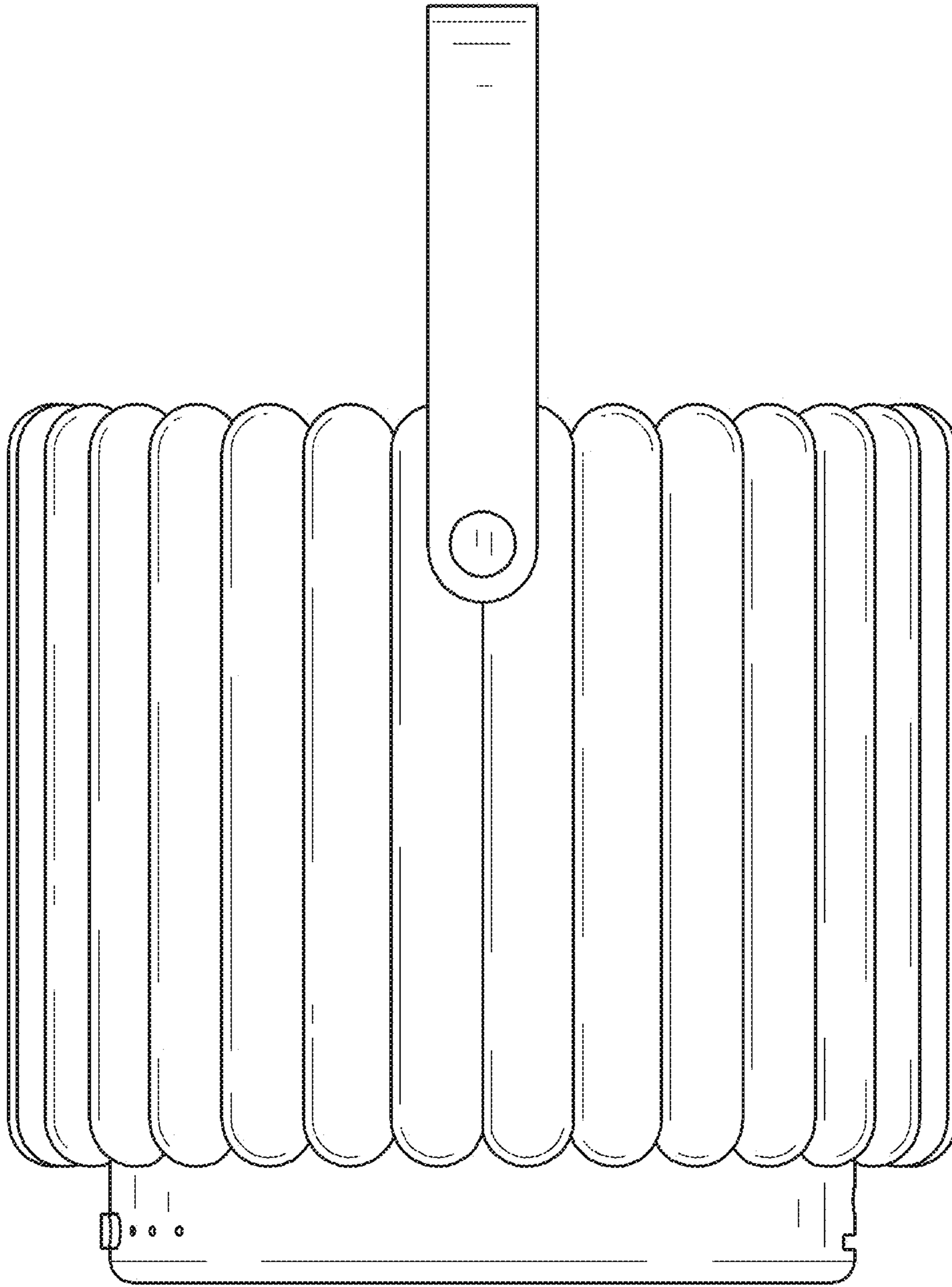

FIG. 54

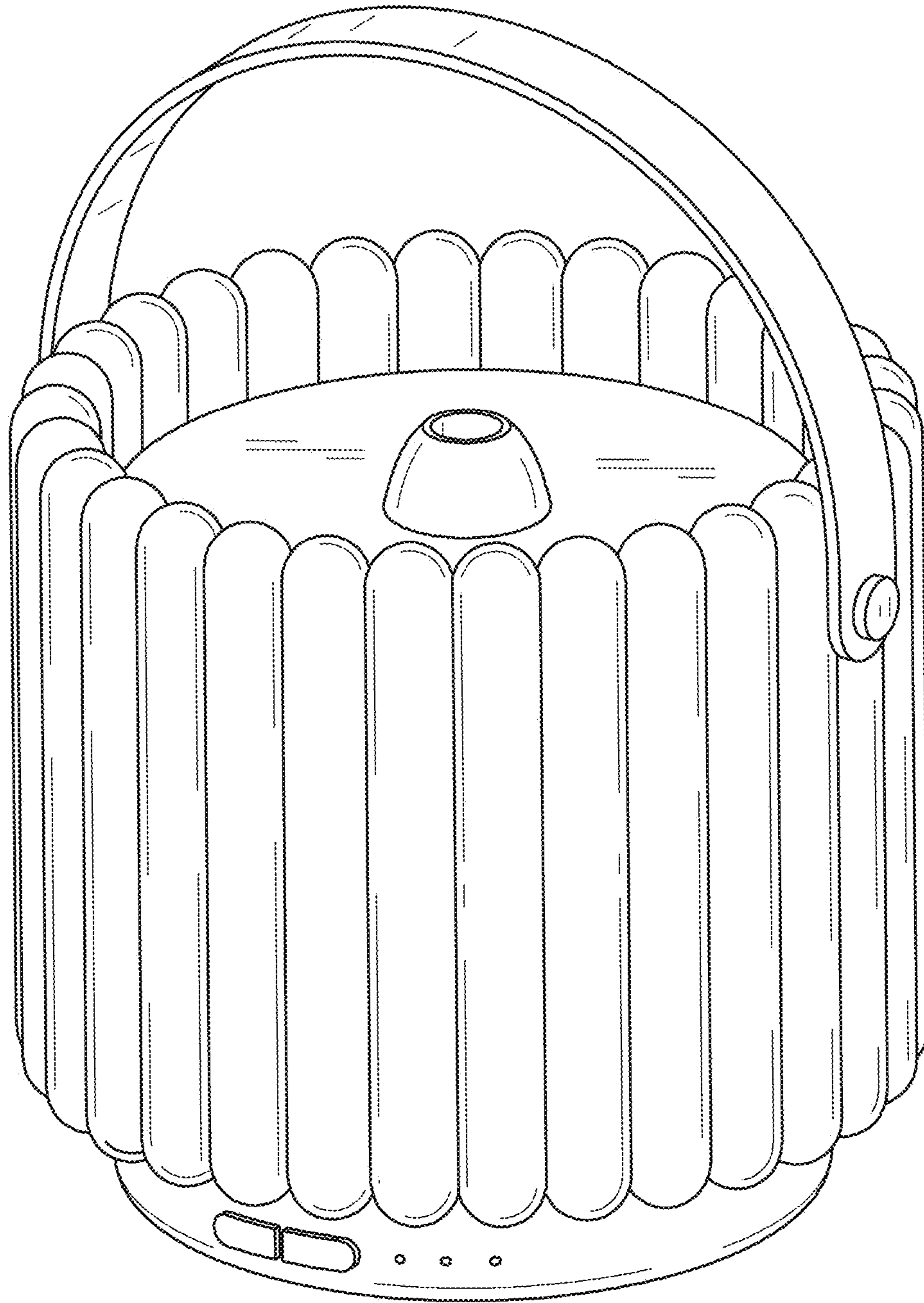

FIG. 55

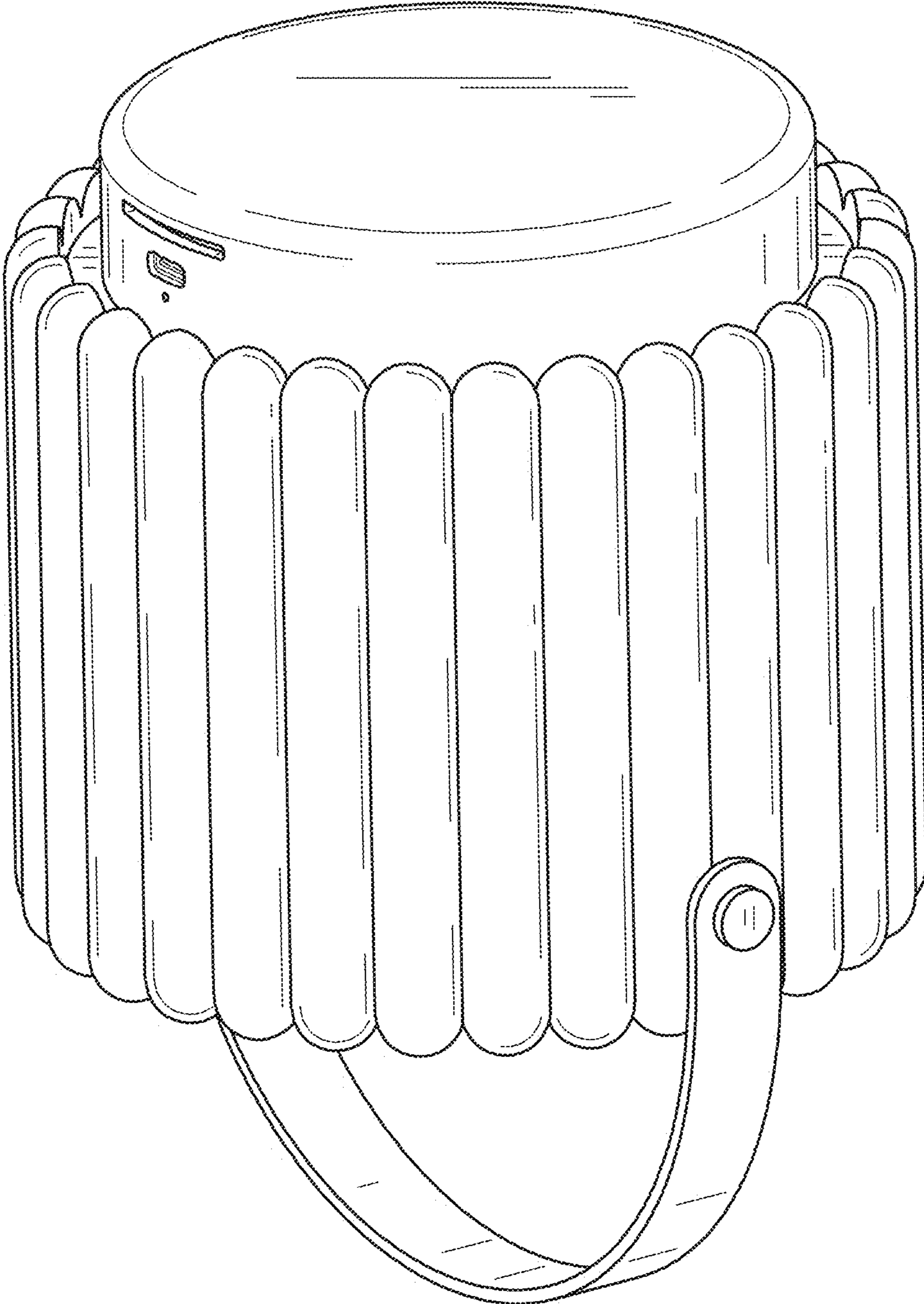

FIG. 56

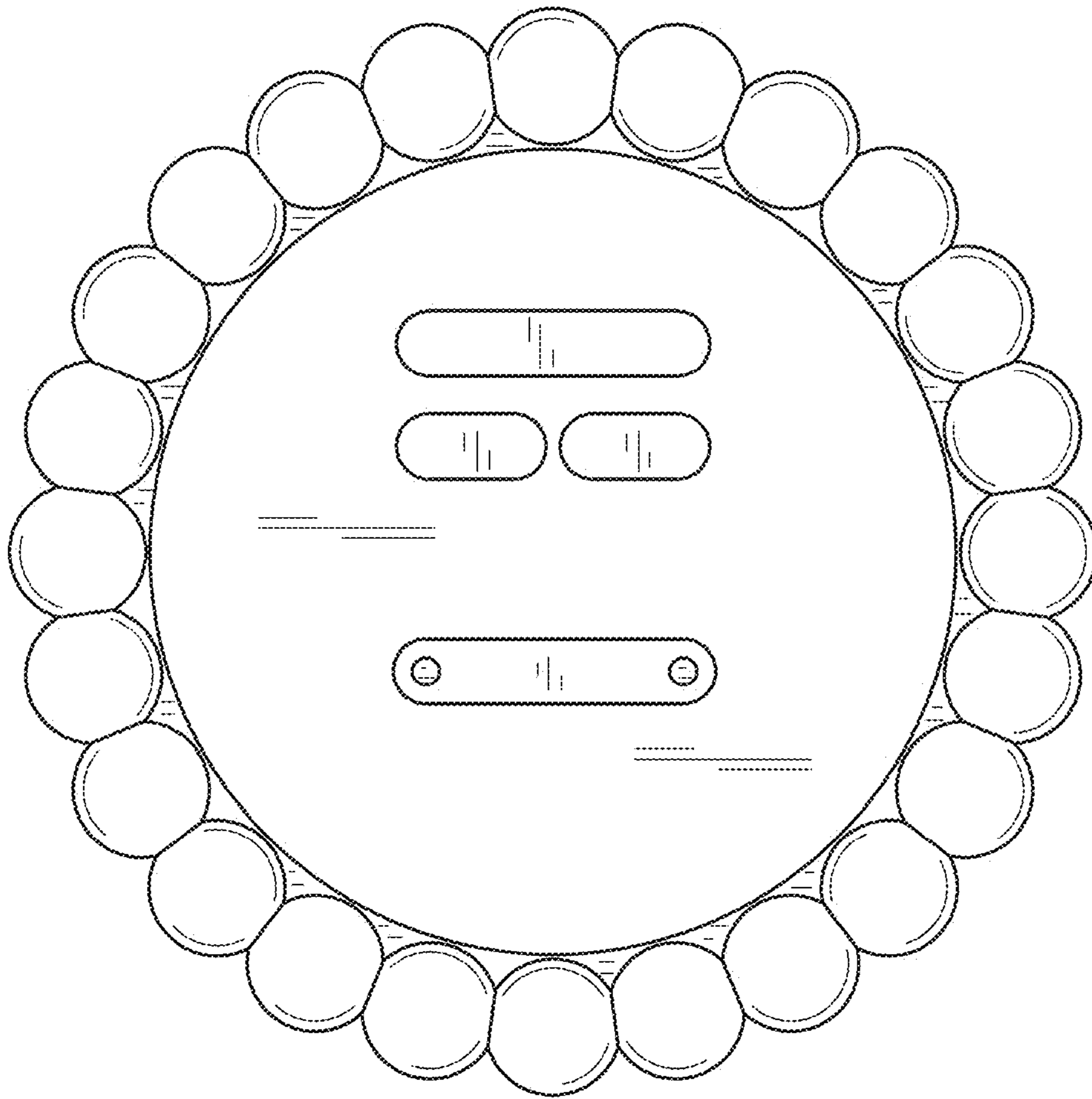

FIG. 57

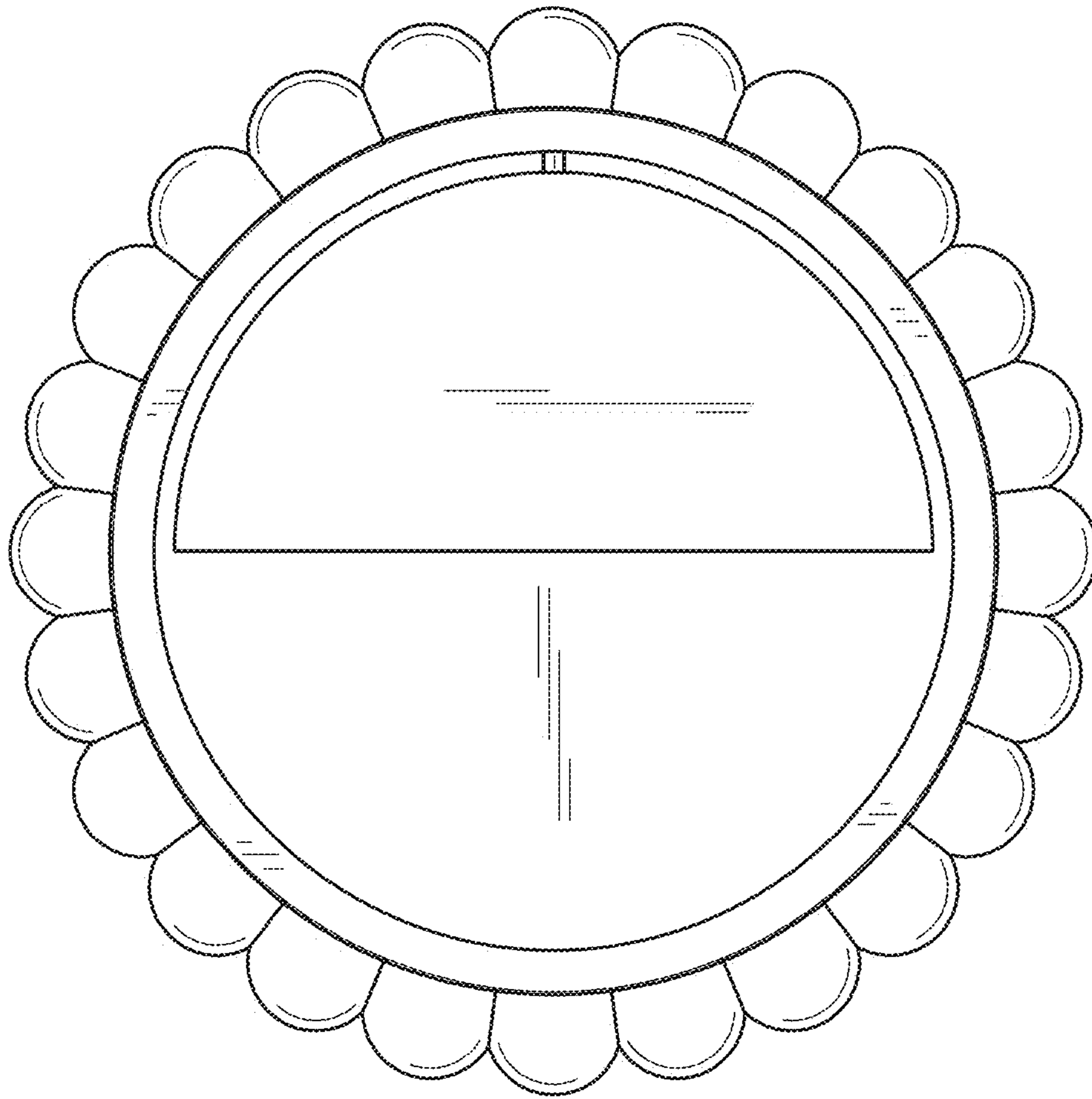

FIG. 58

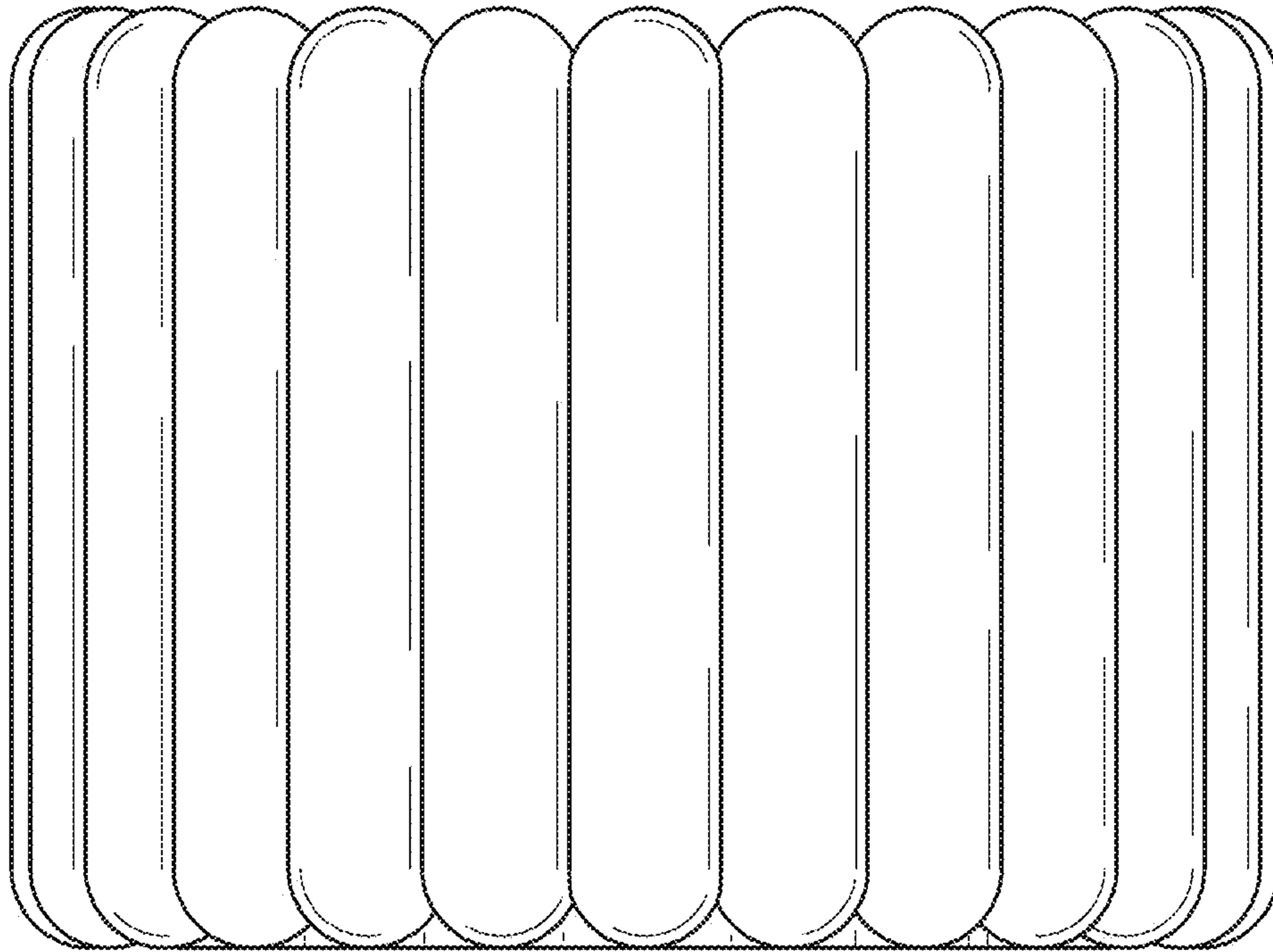

FIG. 59

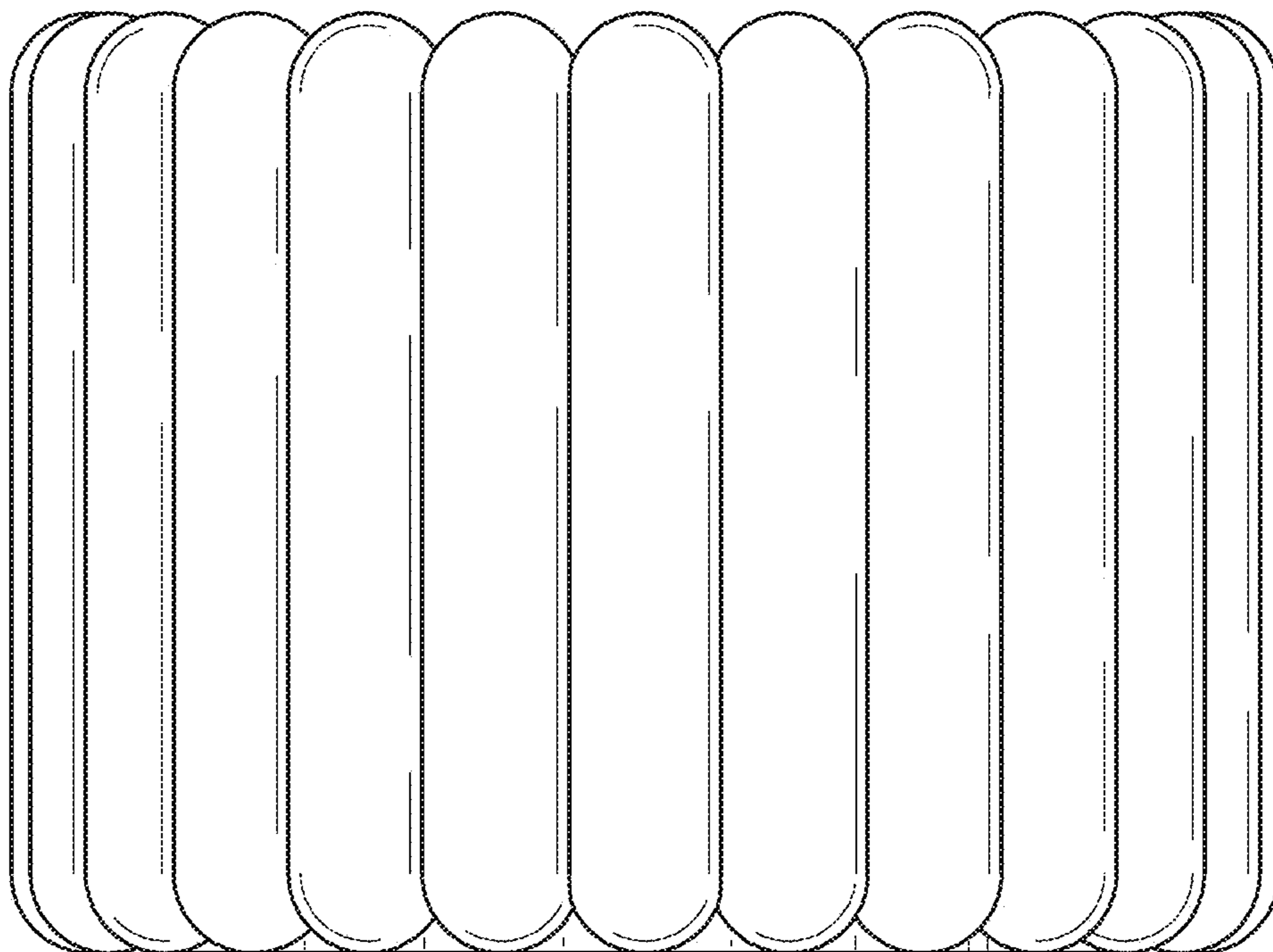

FIG. 60

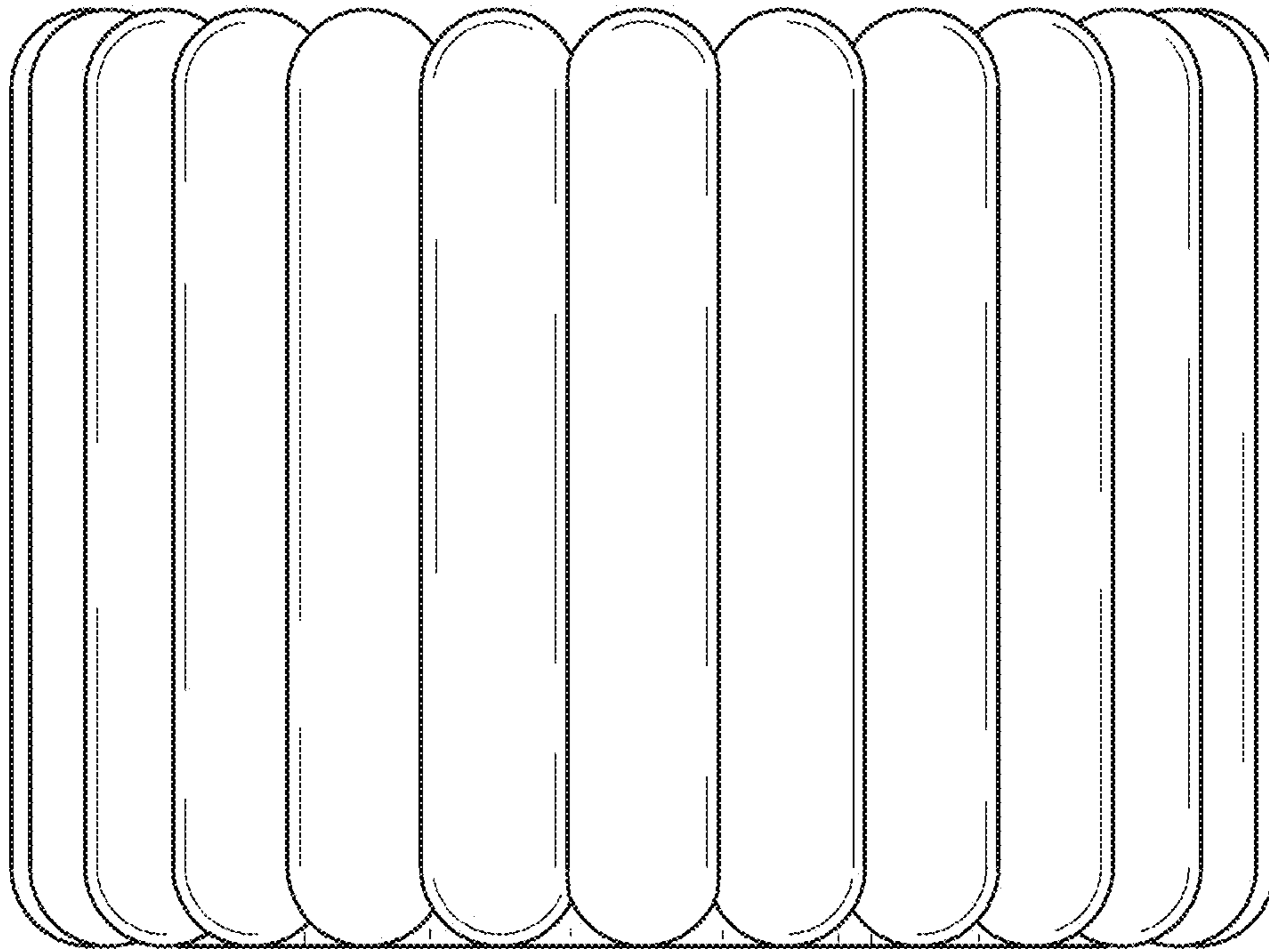

FIG. 61

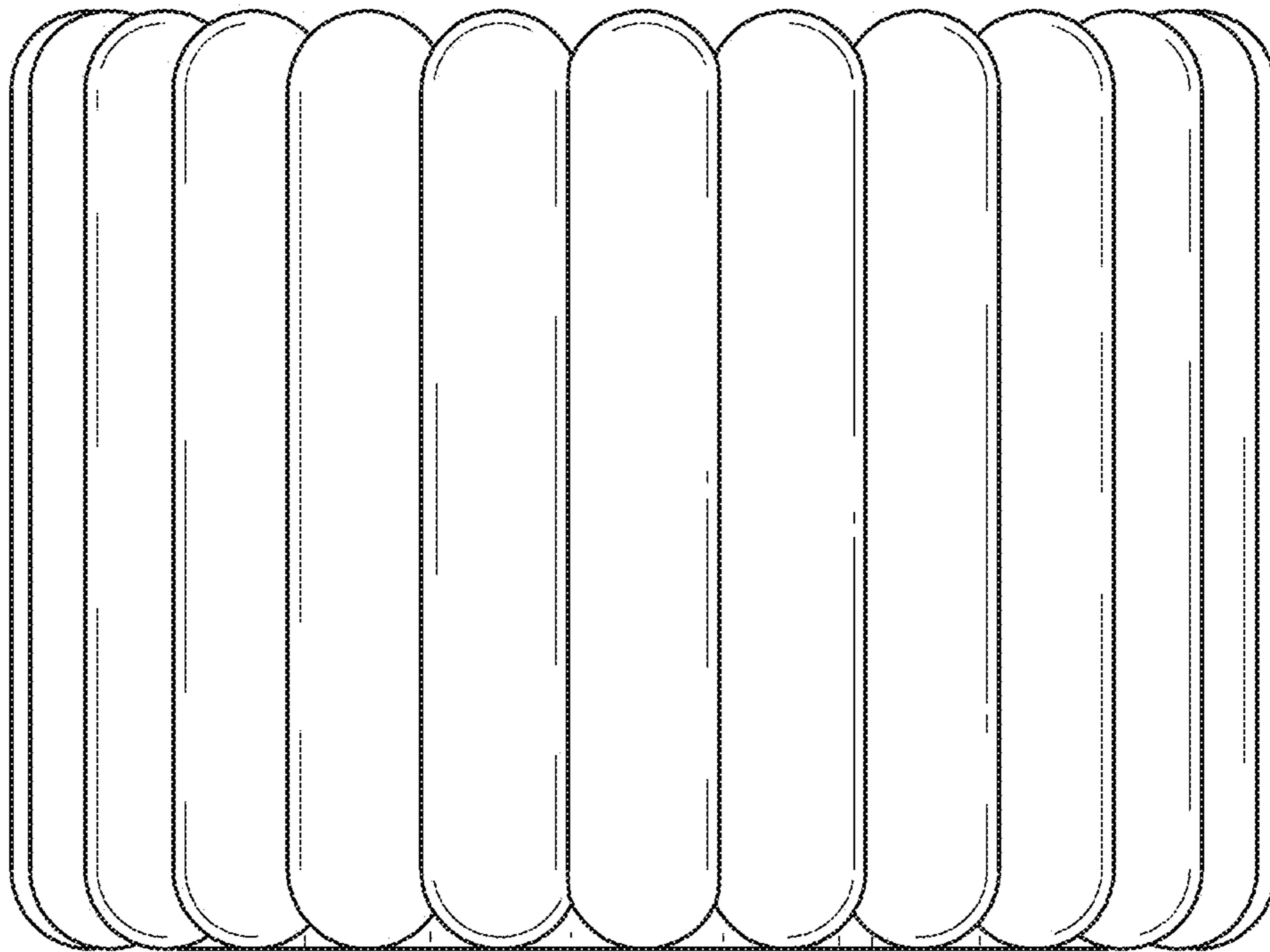

FIG. 62

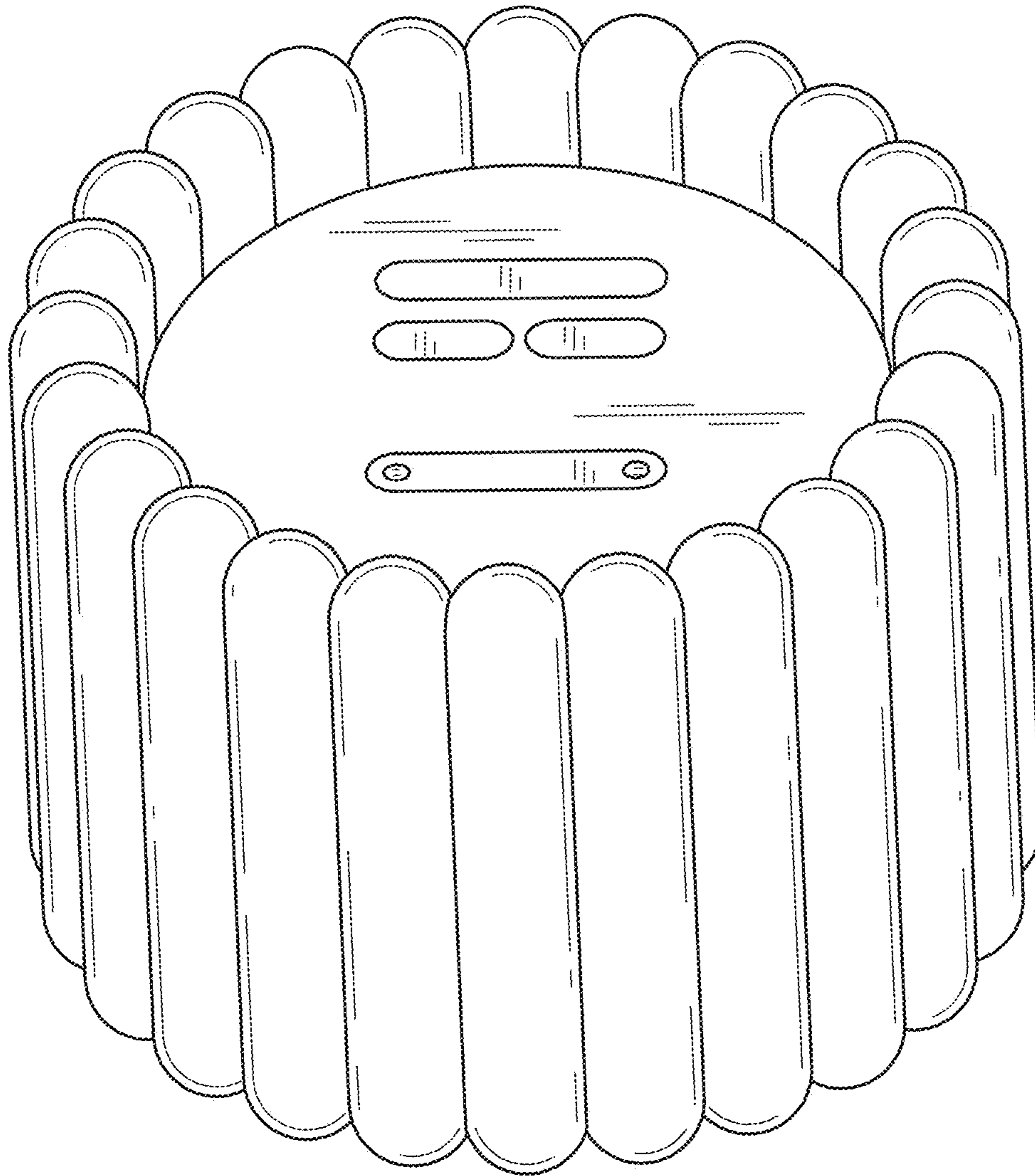

FIG. 63

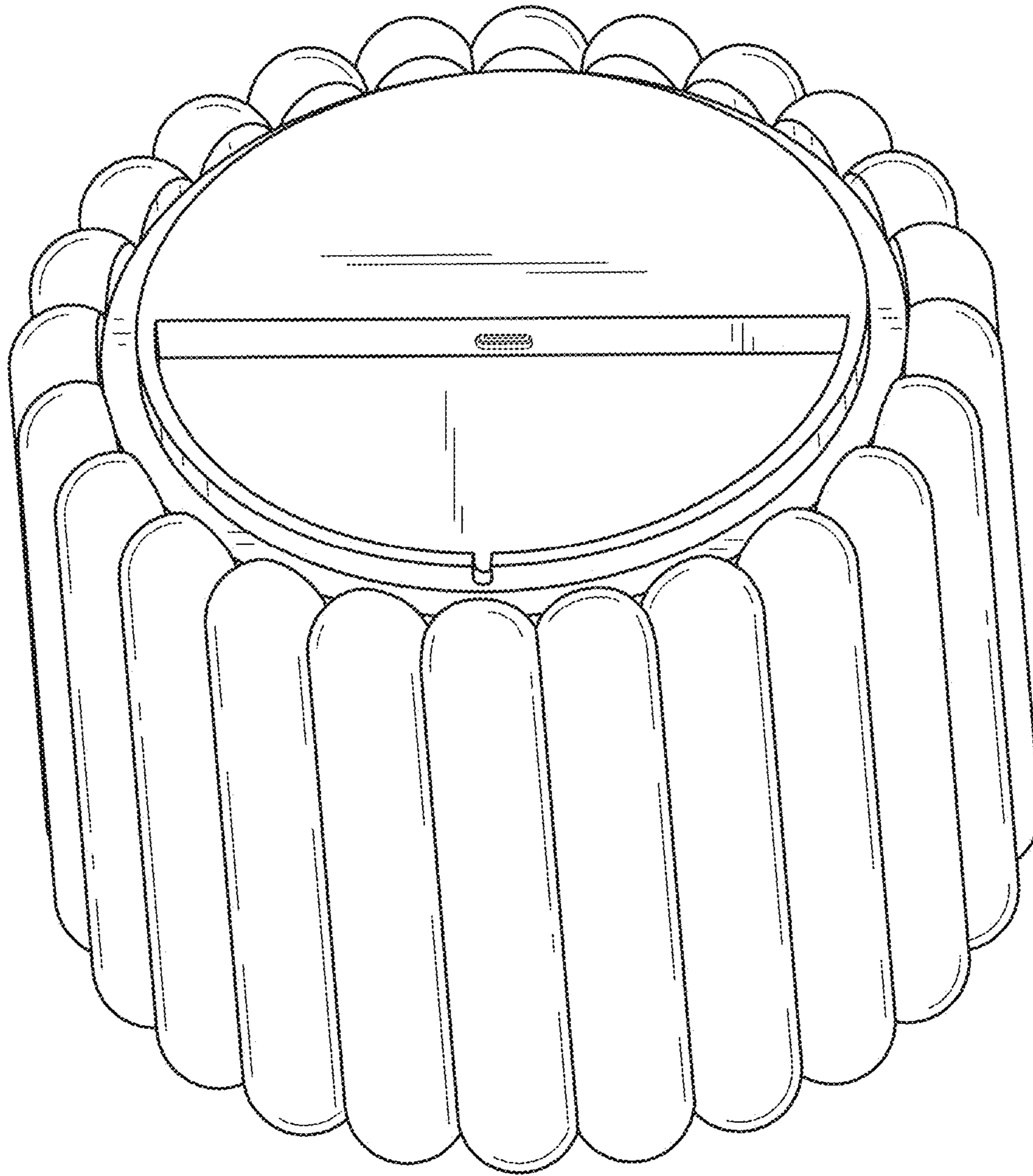

FIG. 64

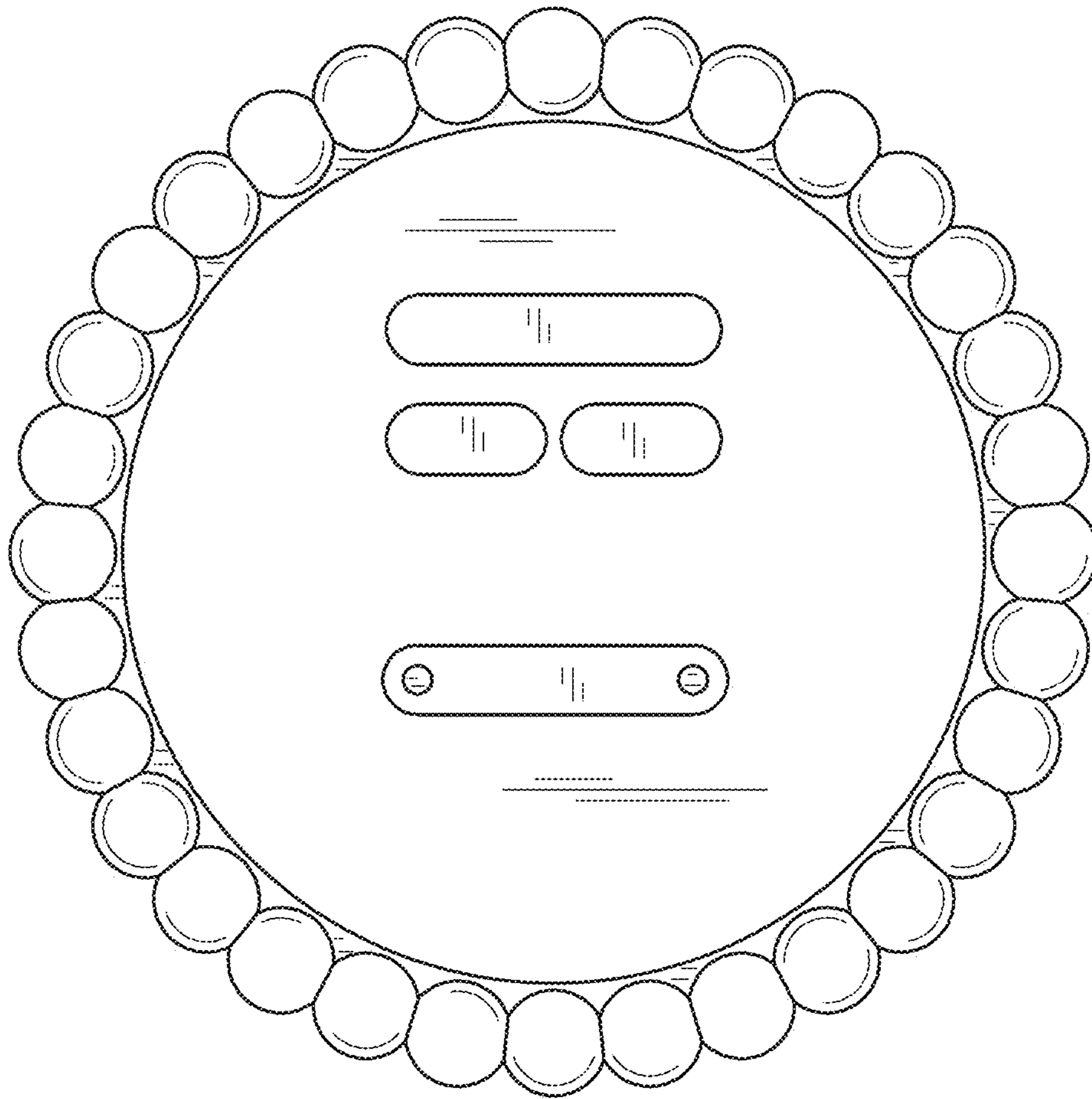

FIG. 65

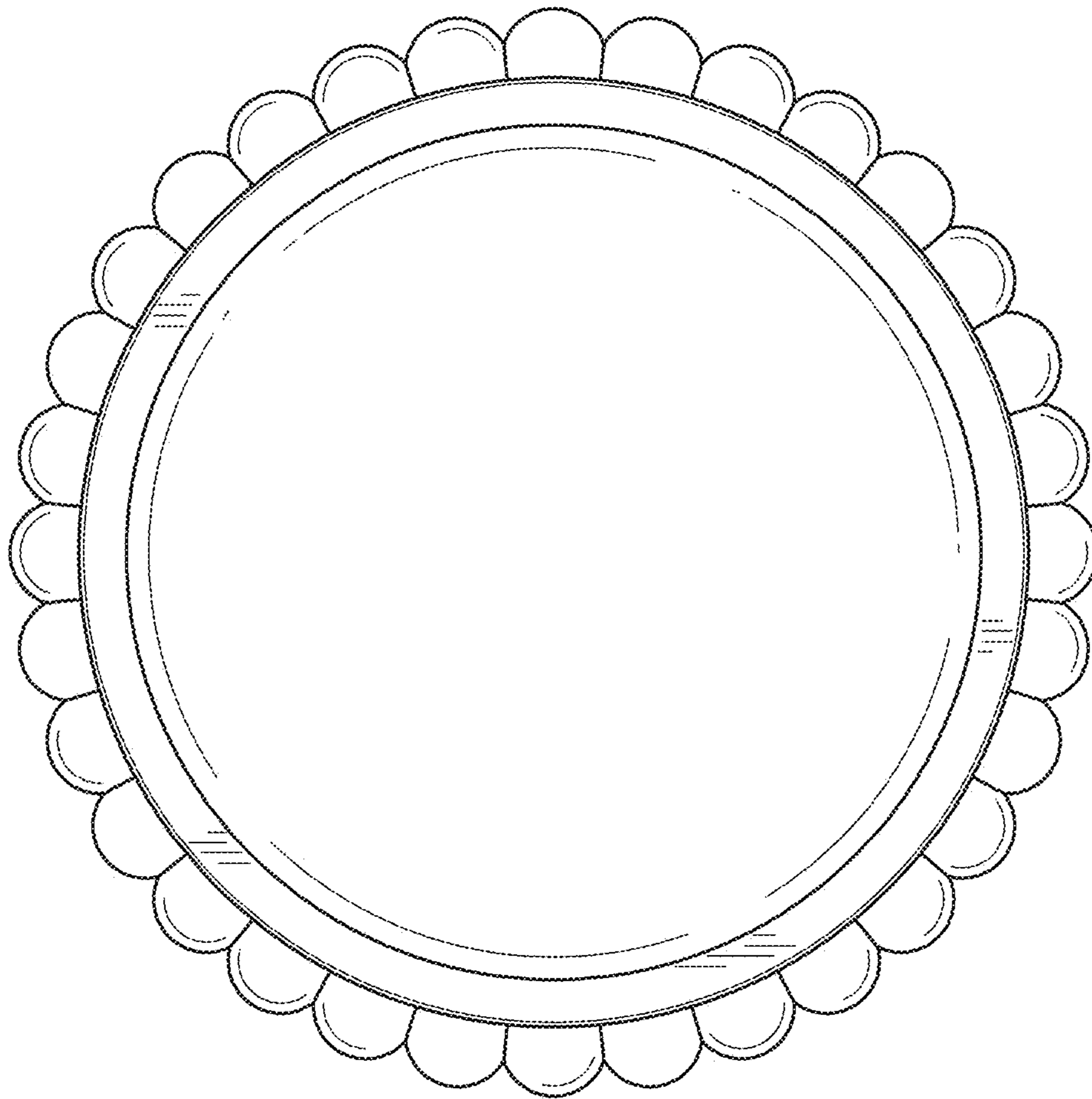

FIG. 66

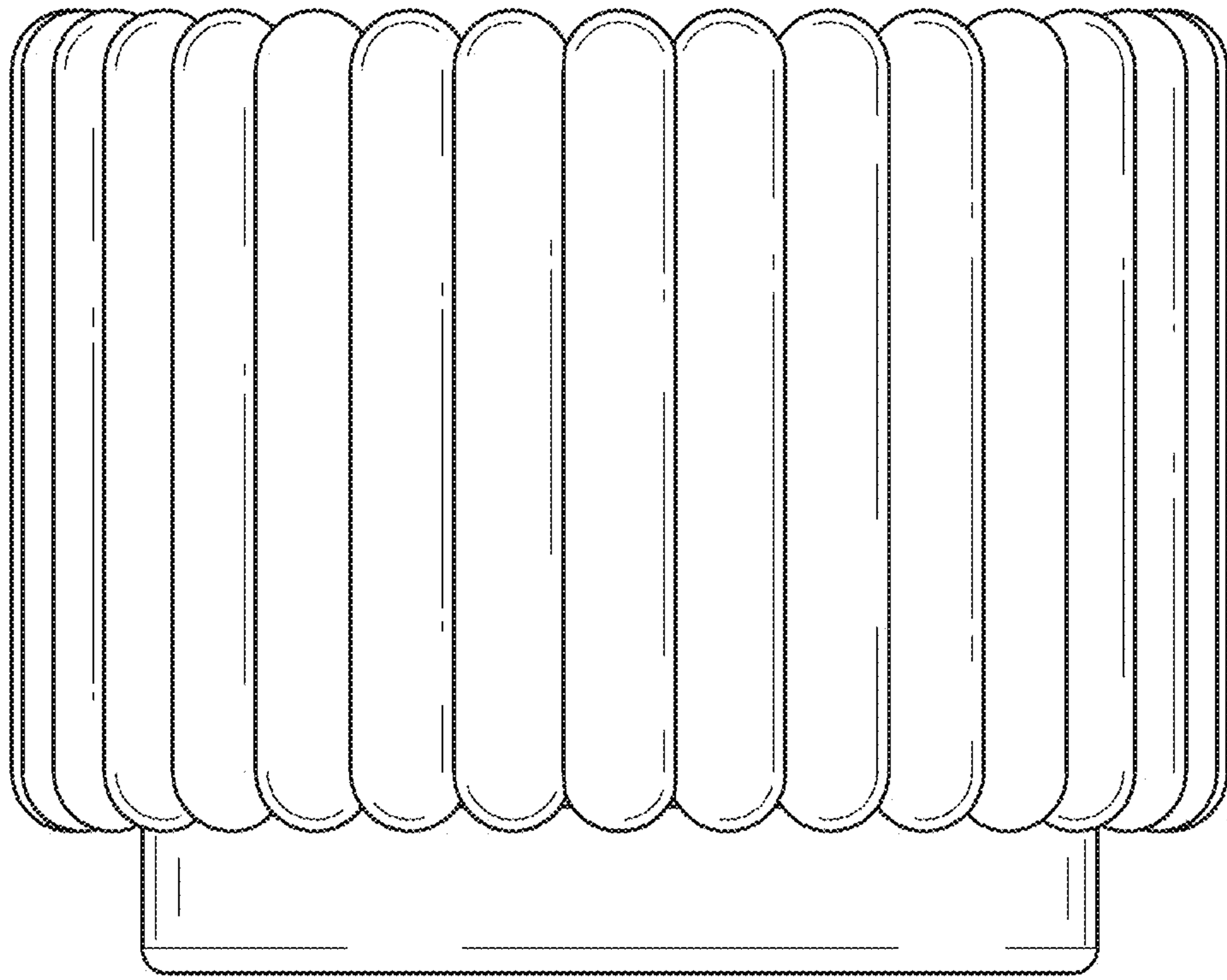

FIG. 67

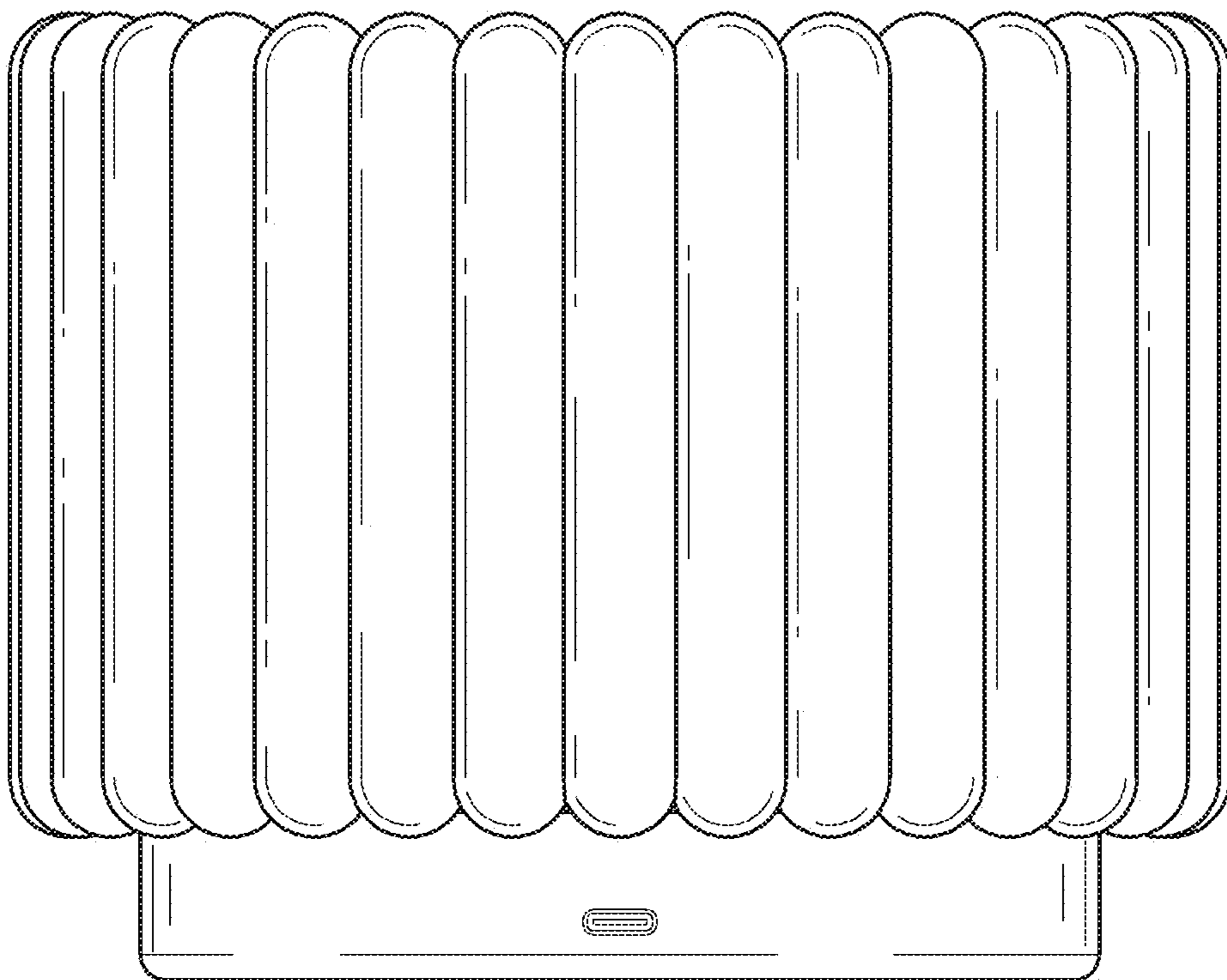

FIG. 68

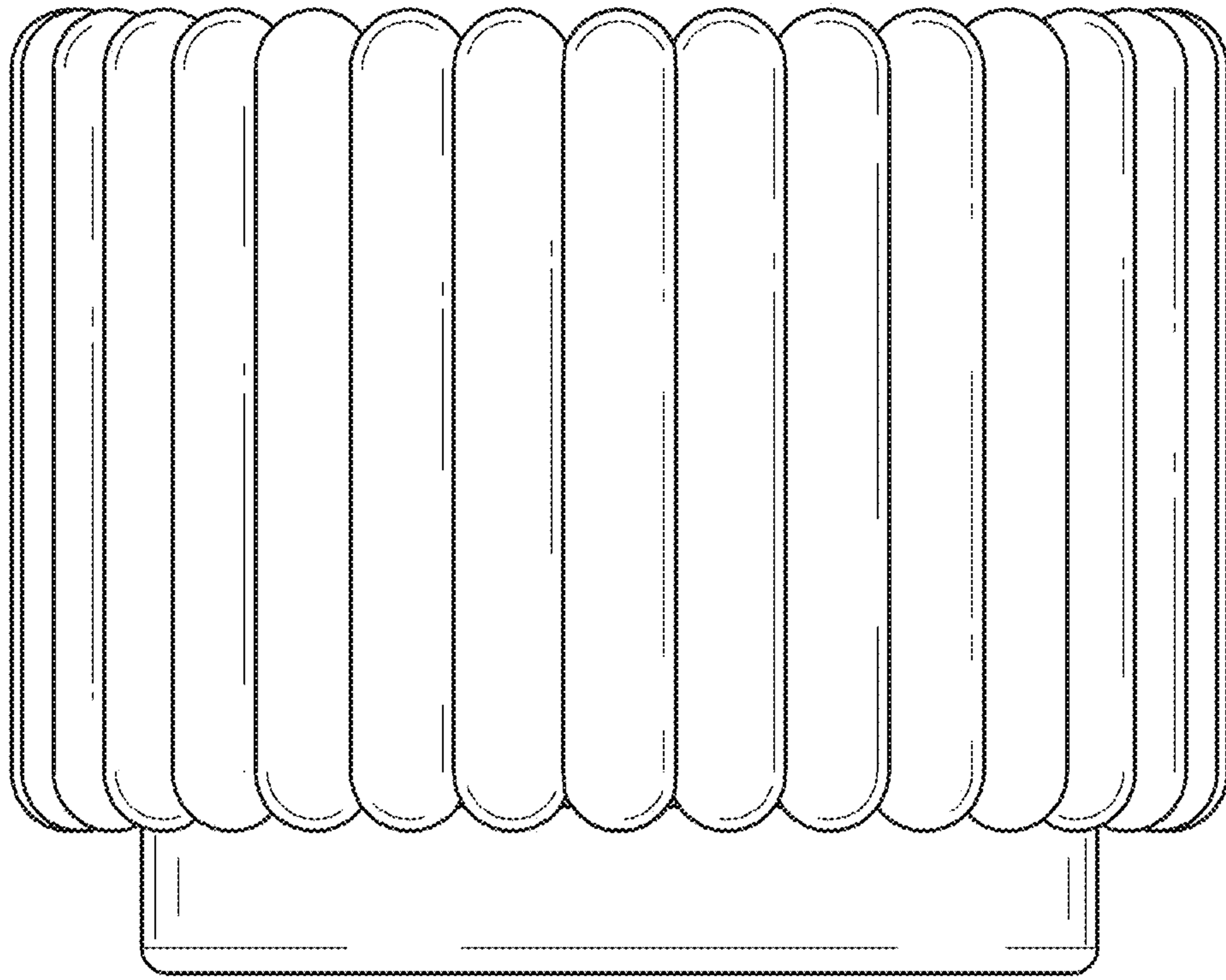

FIG. 69

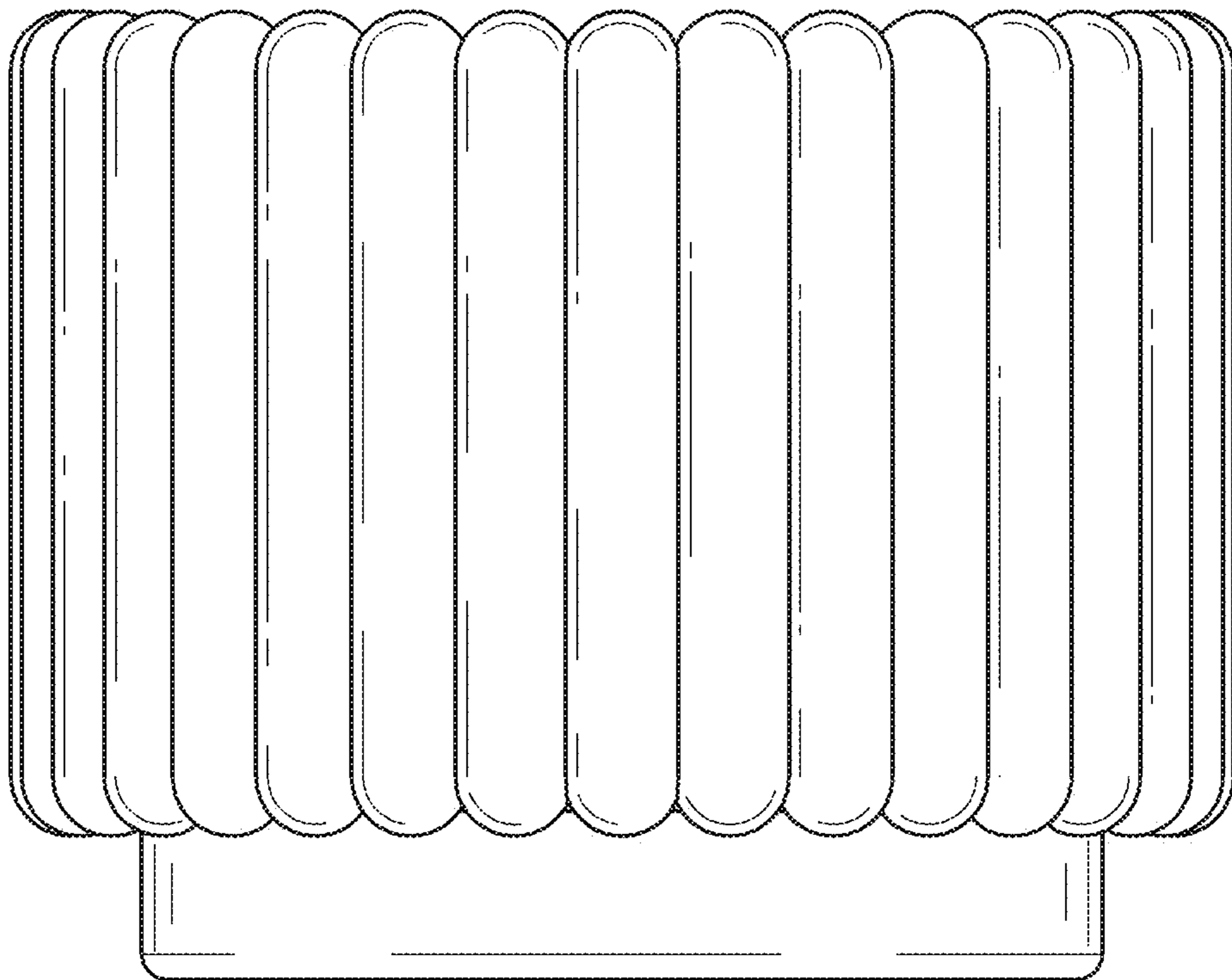

FIG. 70

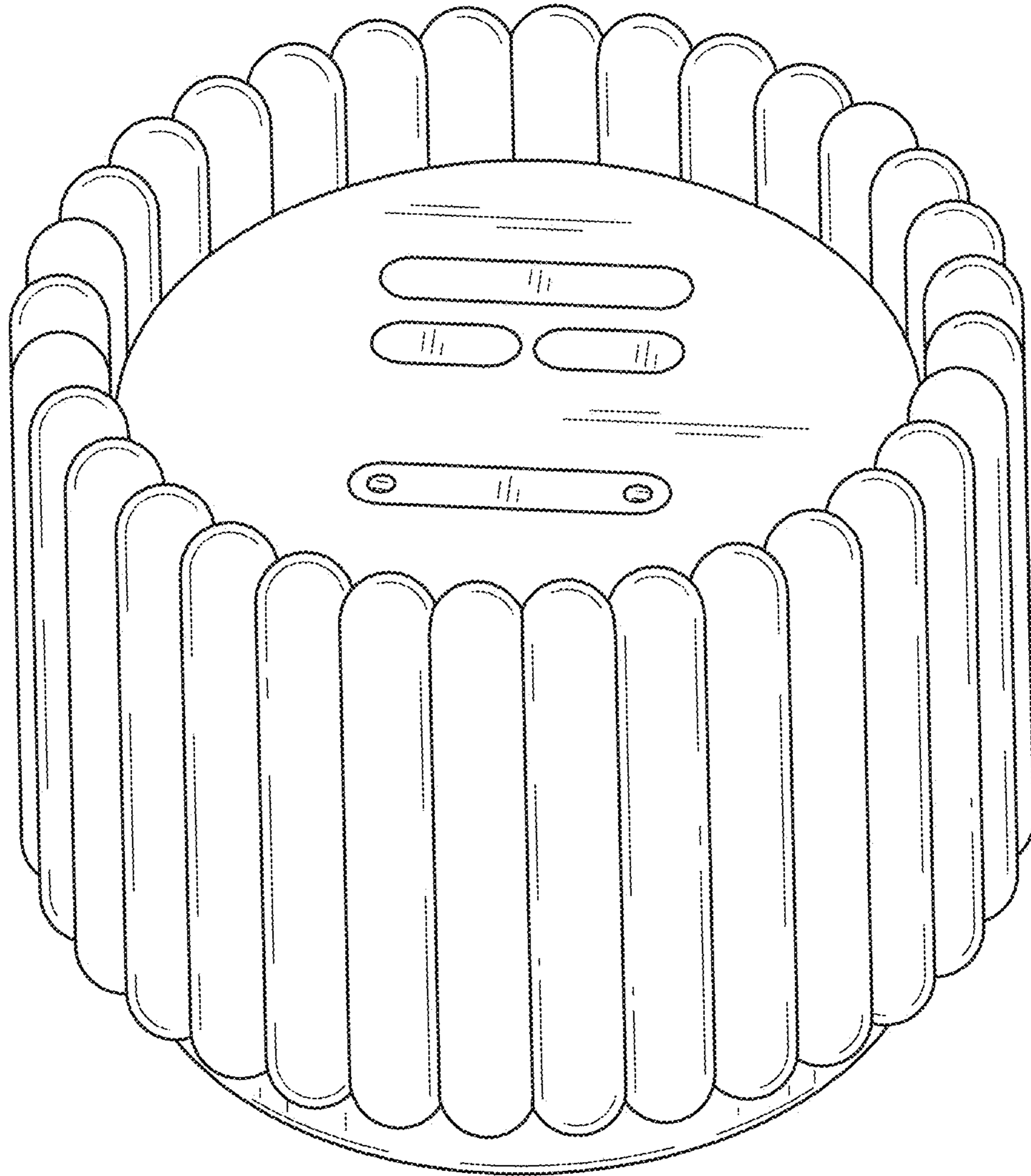

FIG. 71

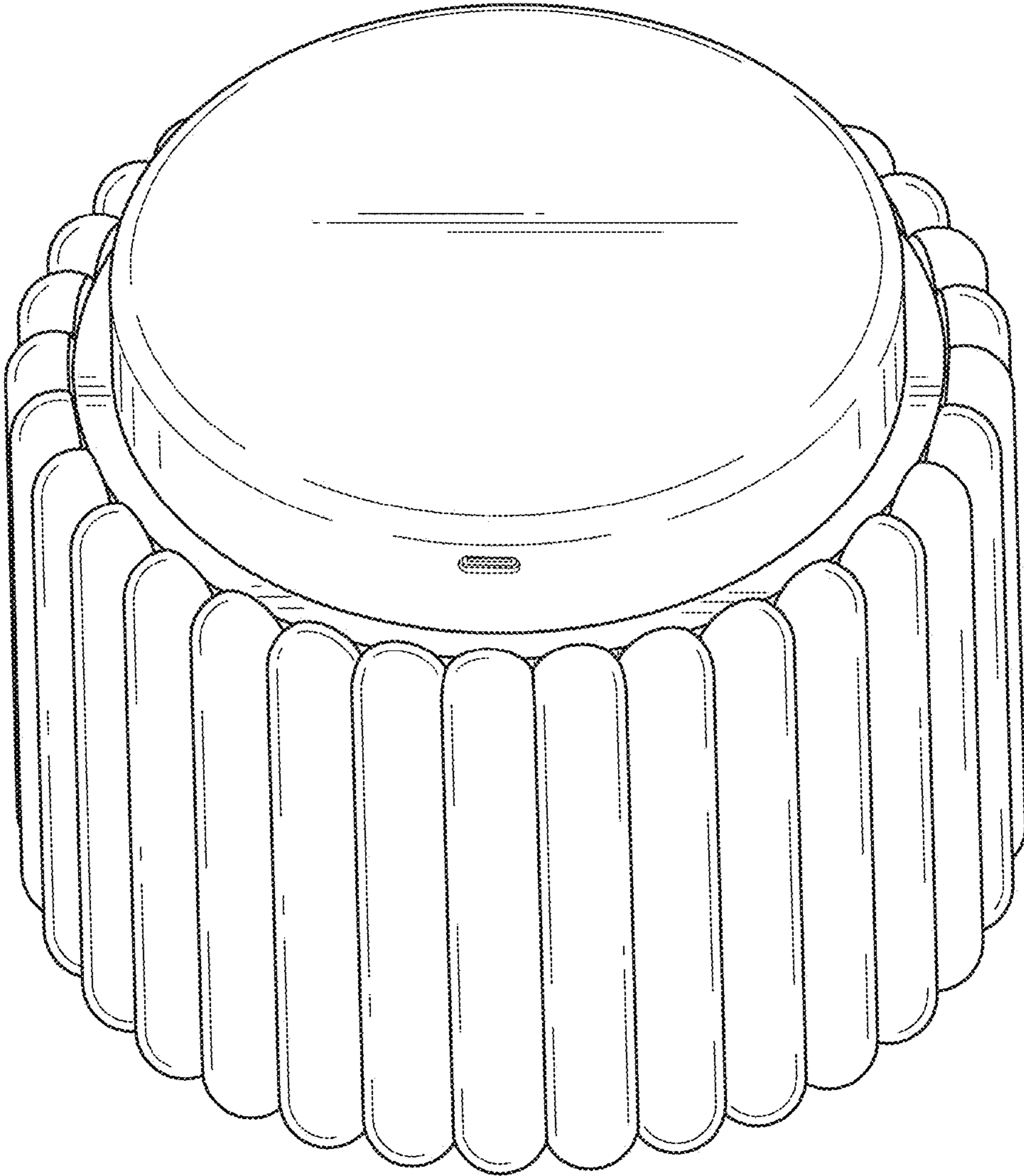

FIG. 72

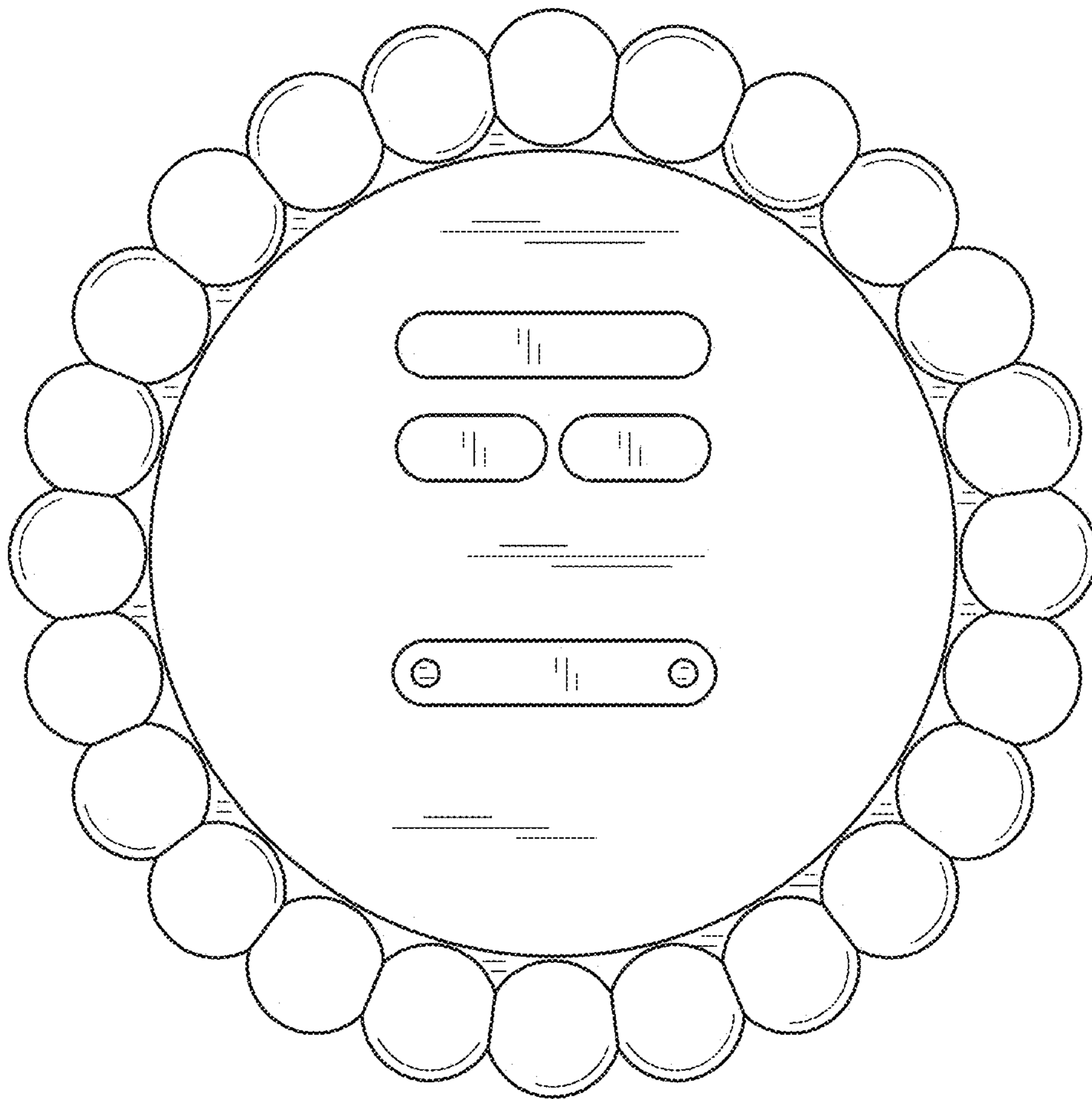

FIG. 73

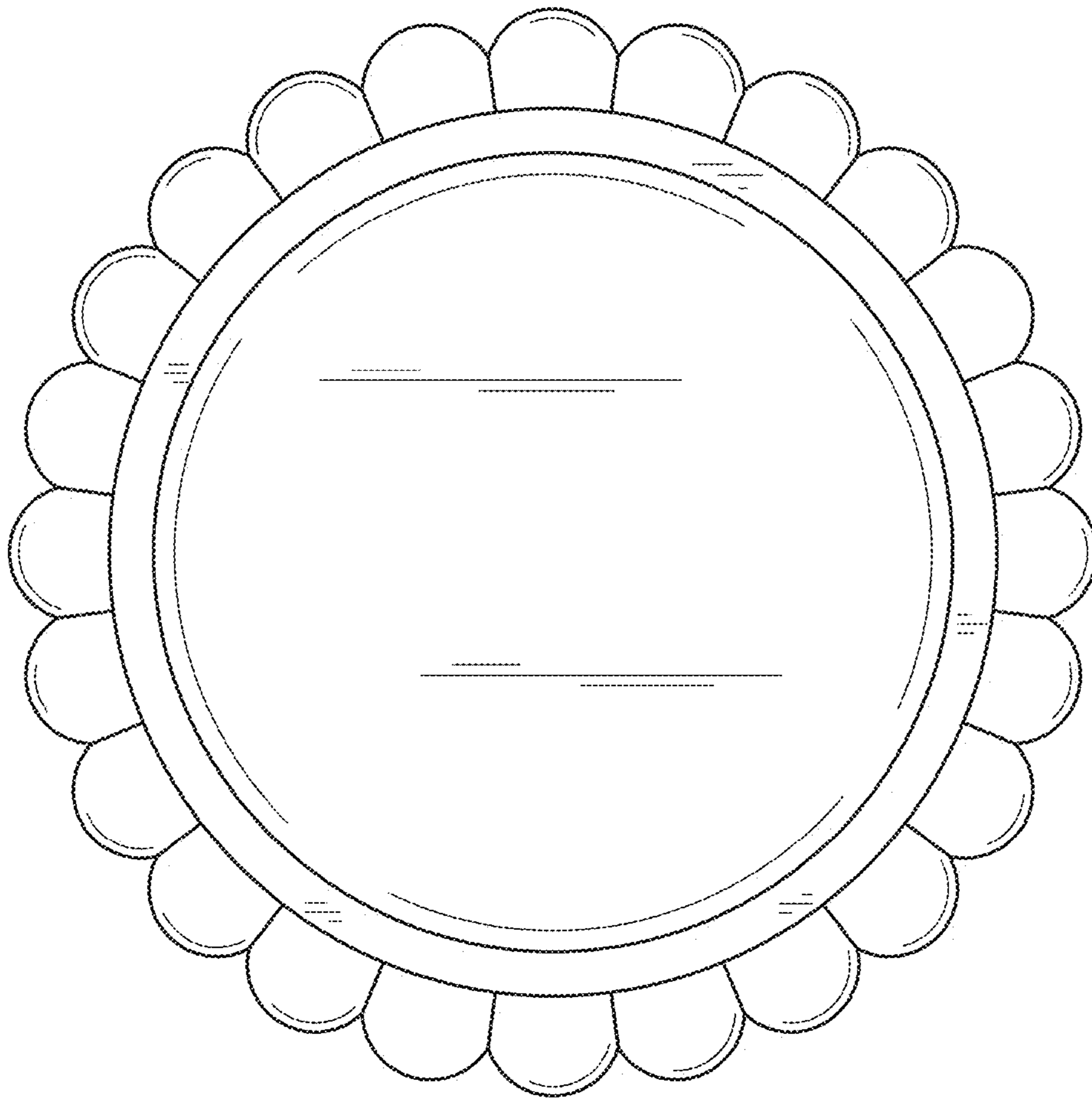

FIG. 74

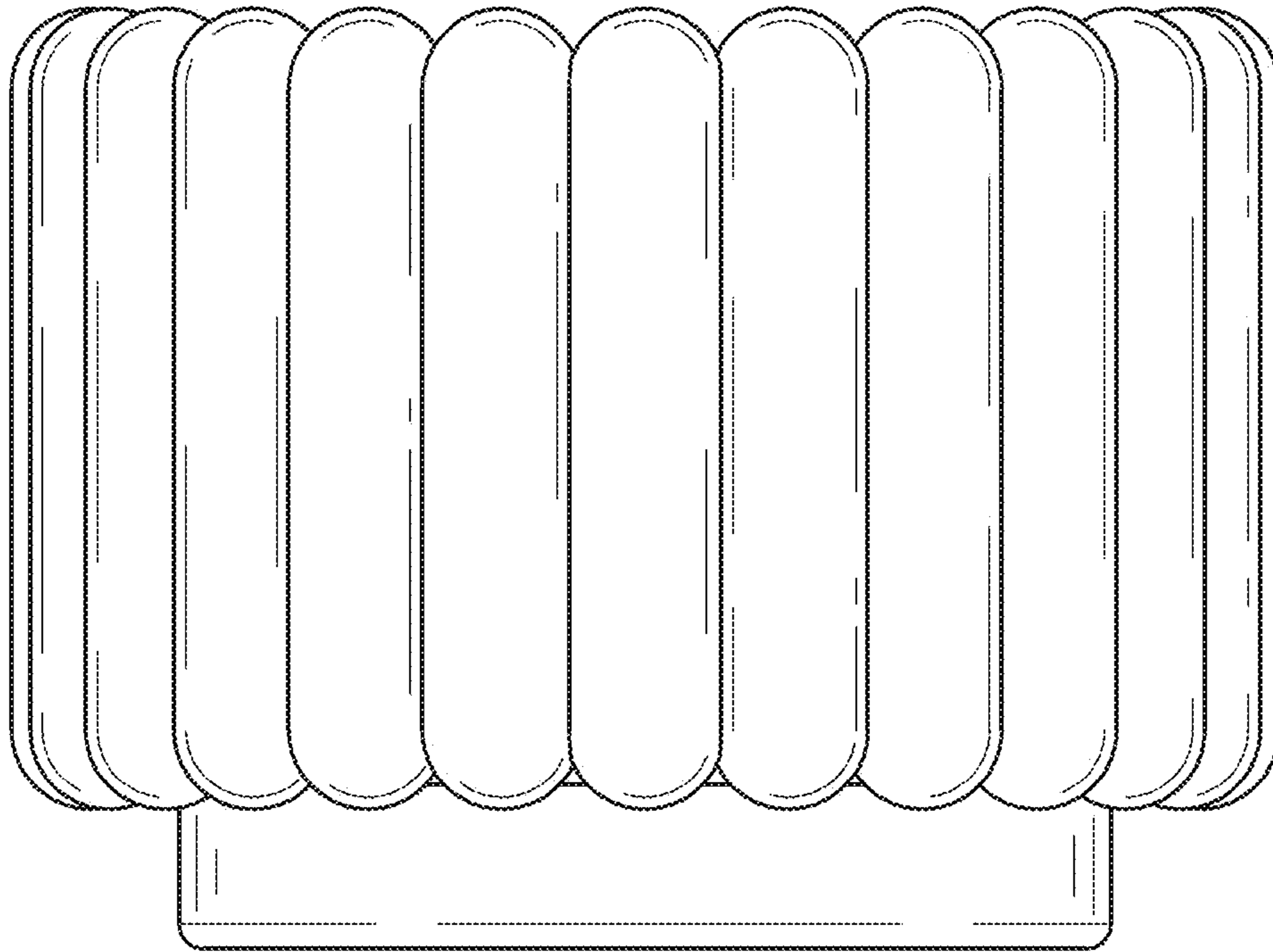

FIG. 75

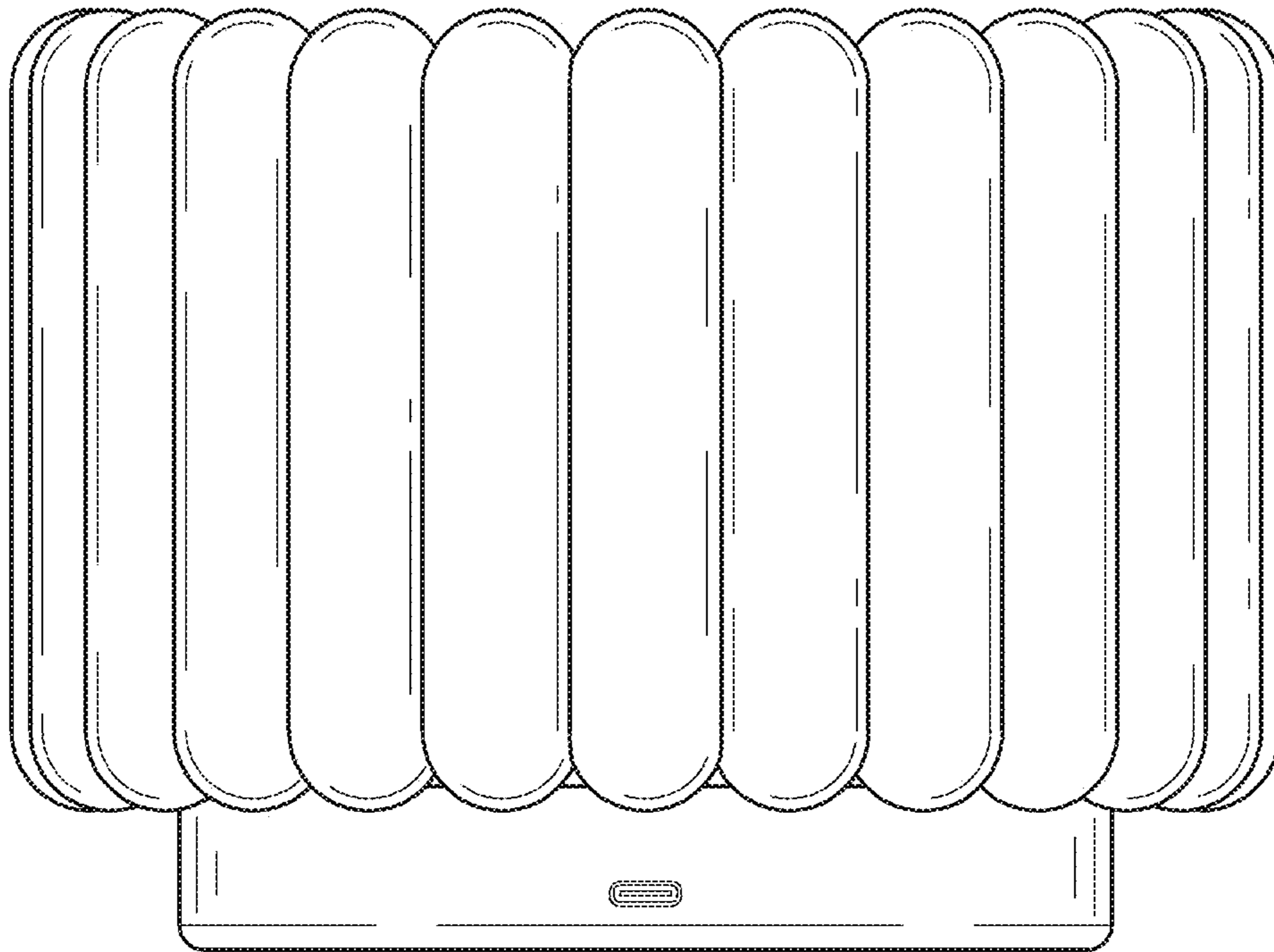

FIG. 76

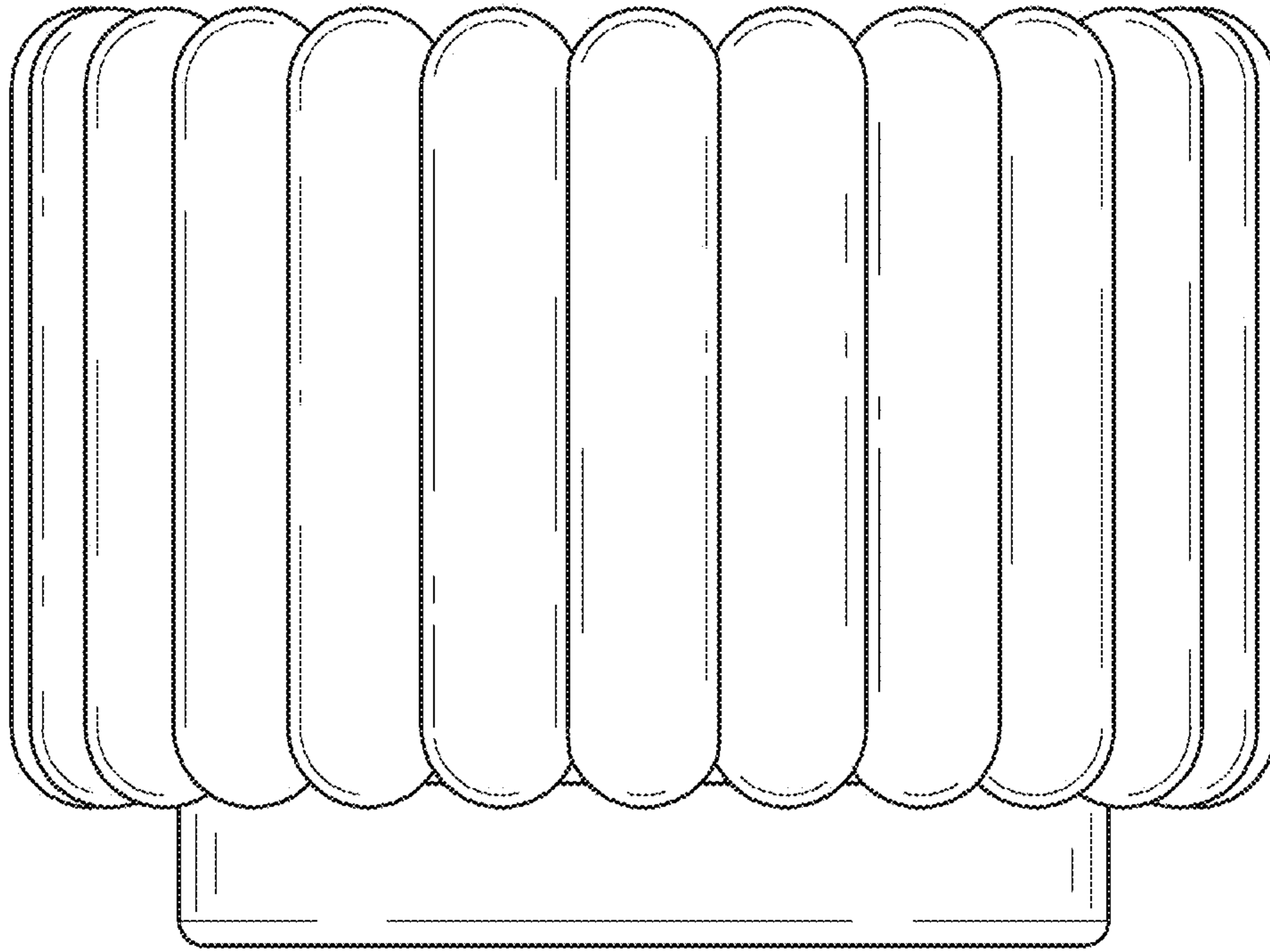

FIG. 77

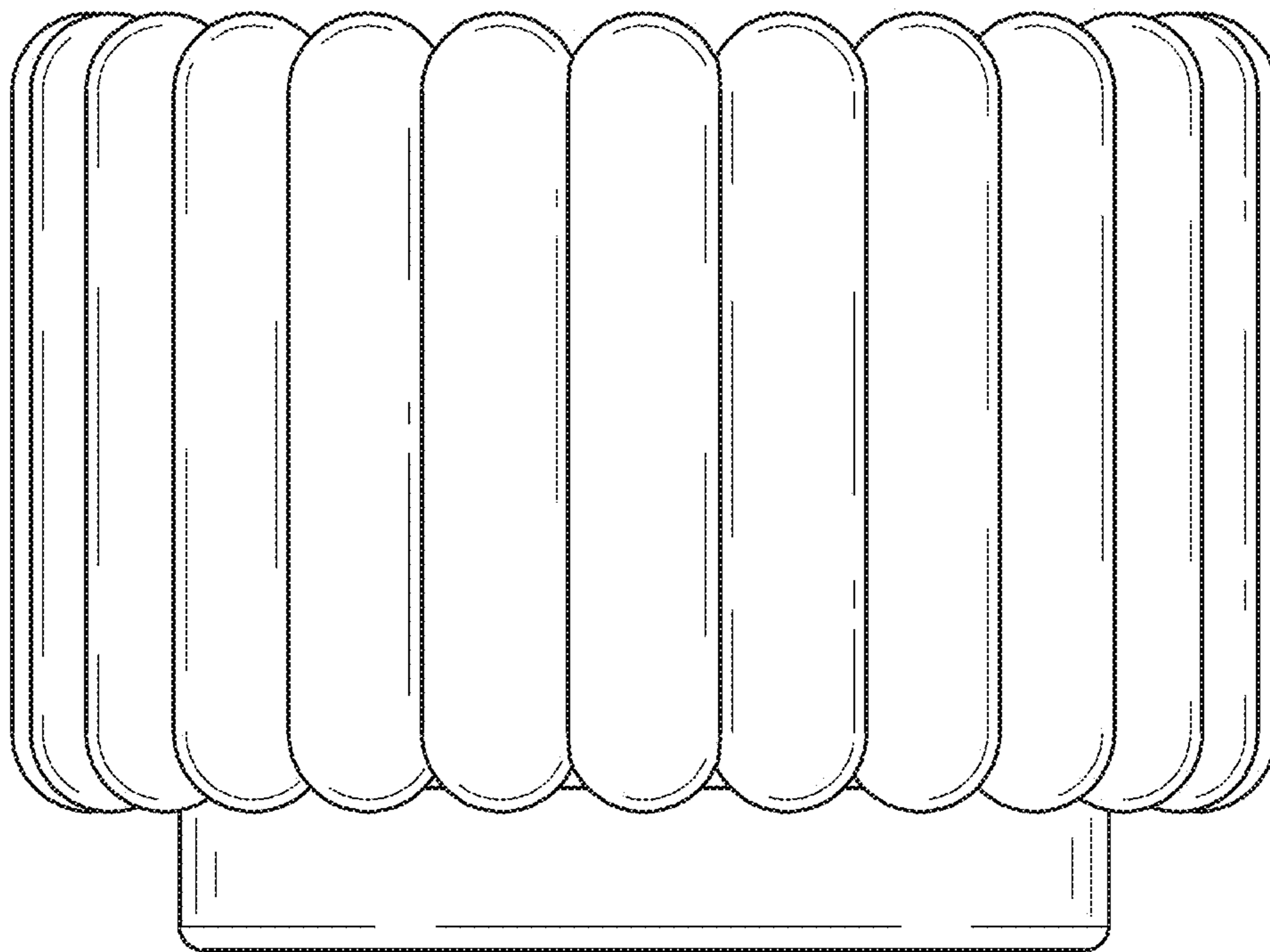

FIG. 78

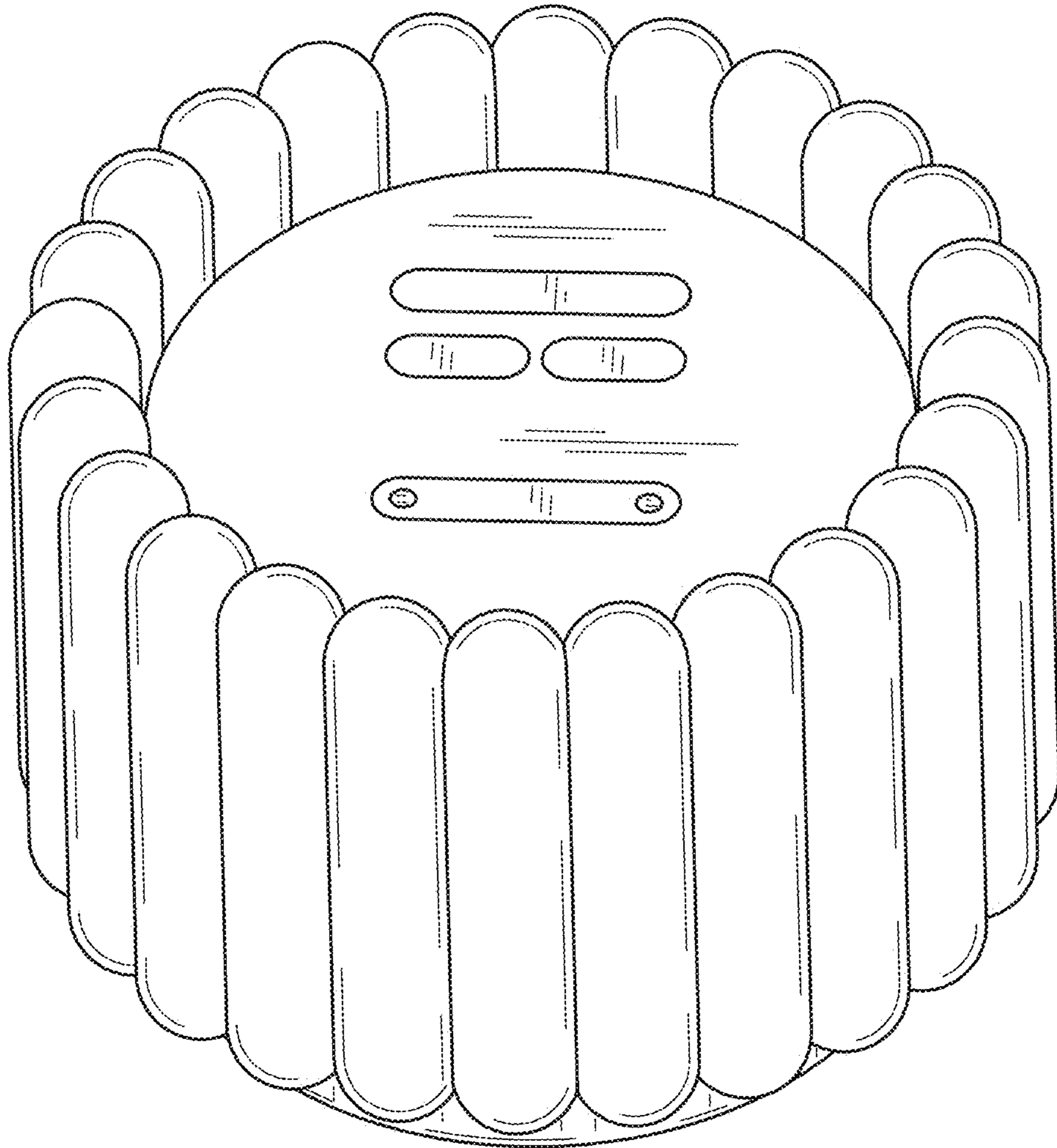

FIG. 79

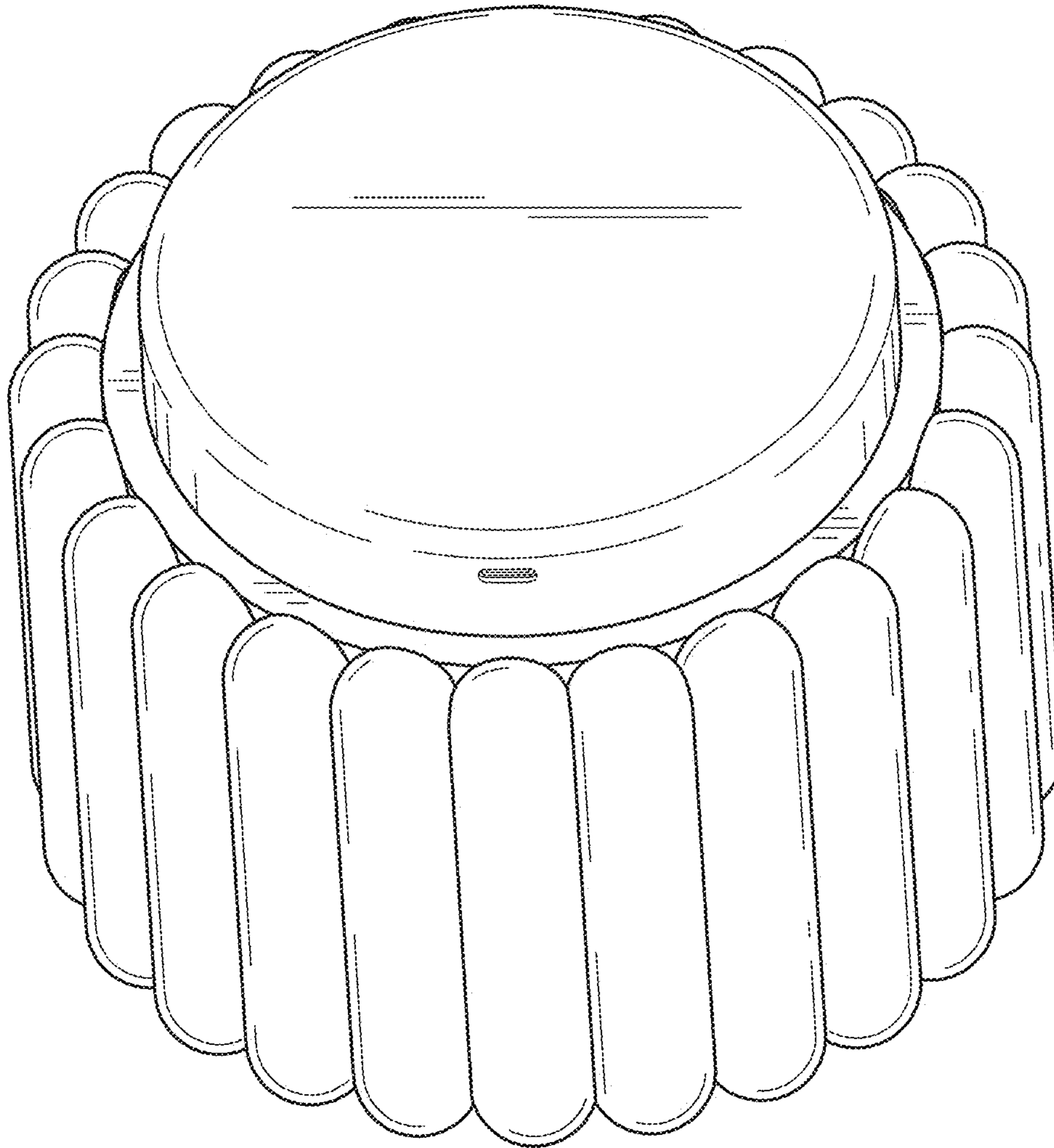

FIG. 80

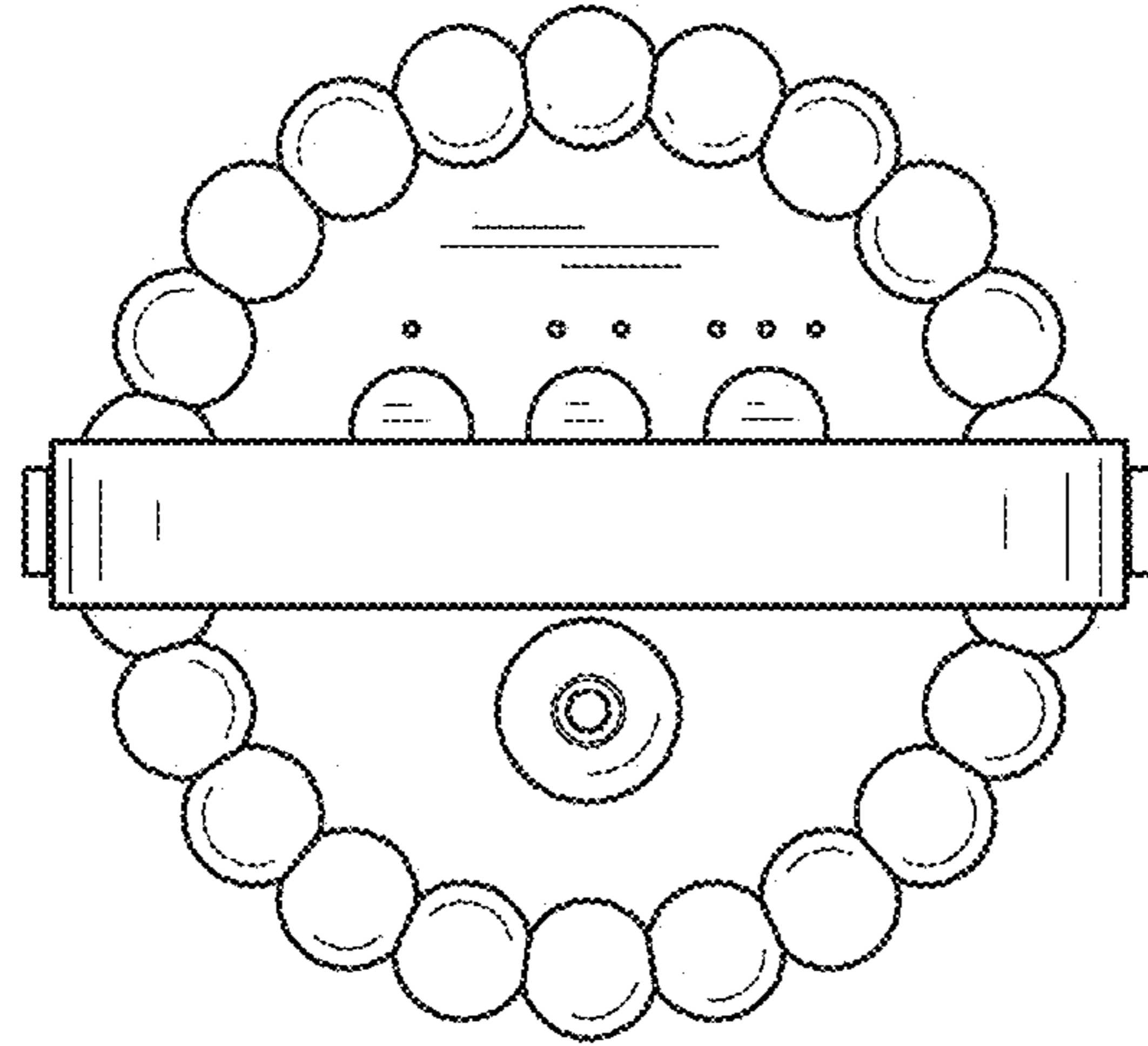

FIG. 81

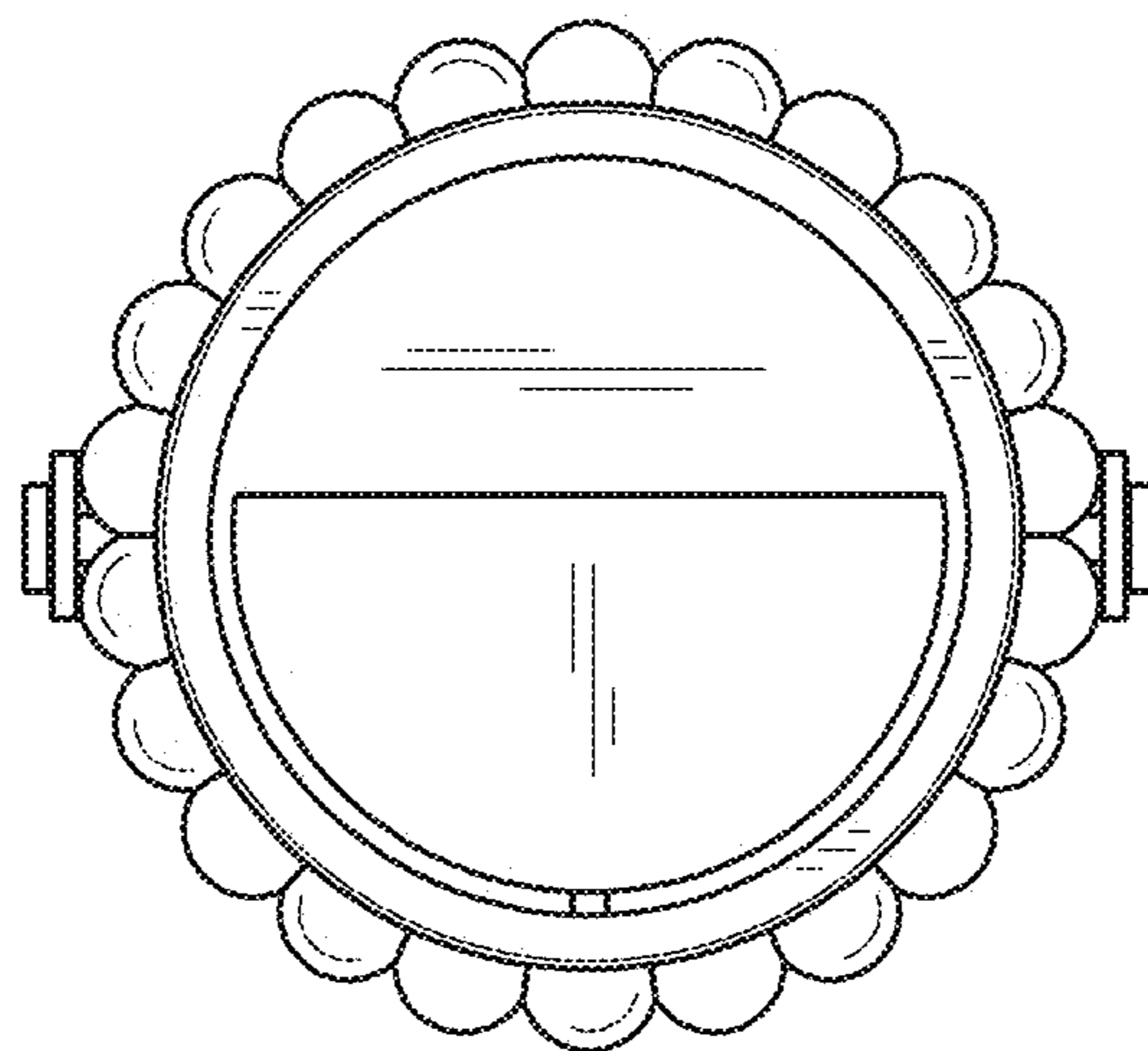

FIG. 82

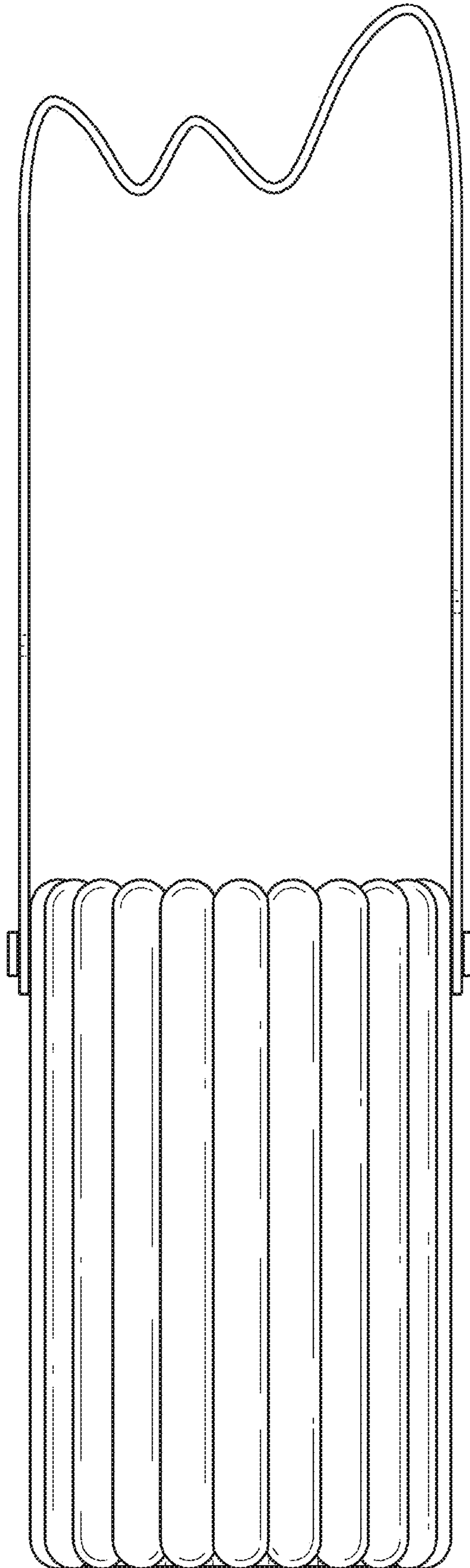

FIG. 83

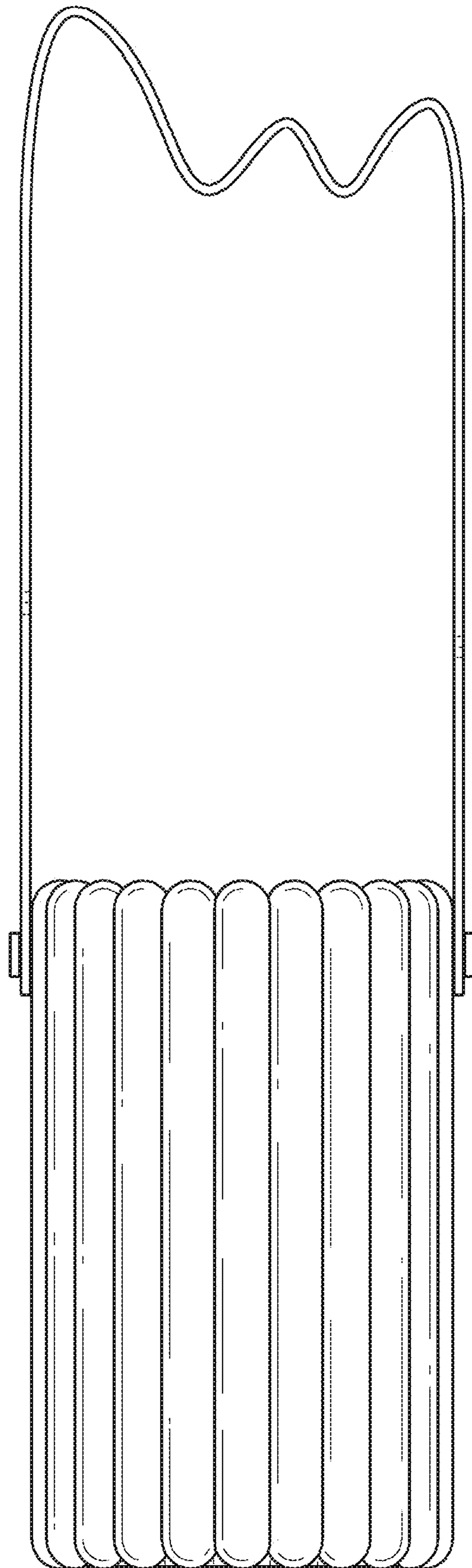

FIG. 84

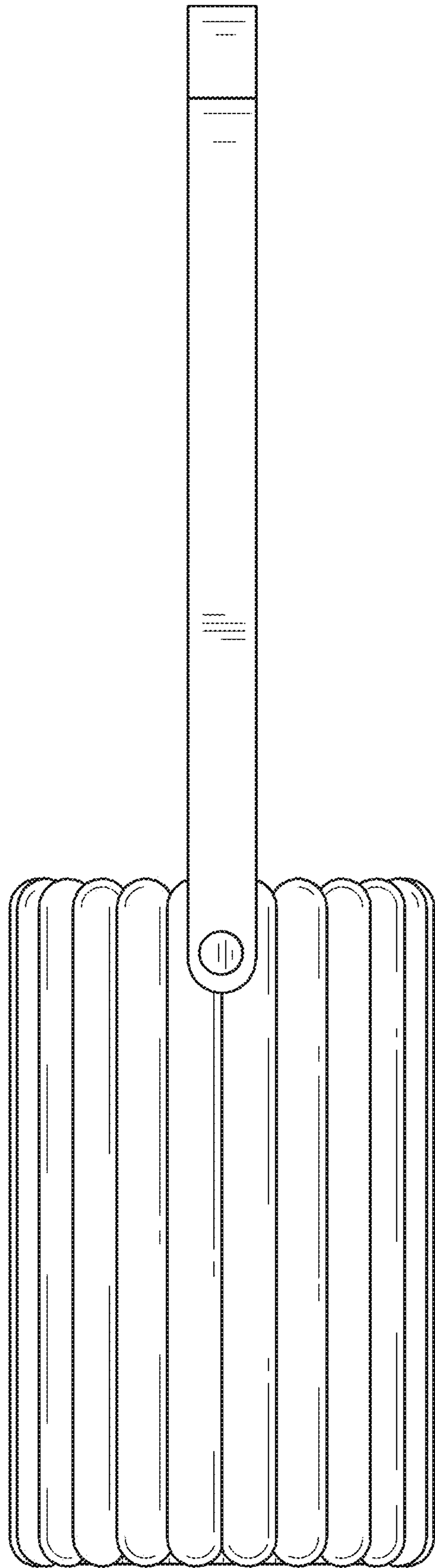

FIG. 85

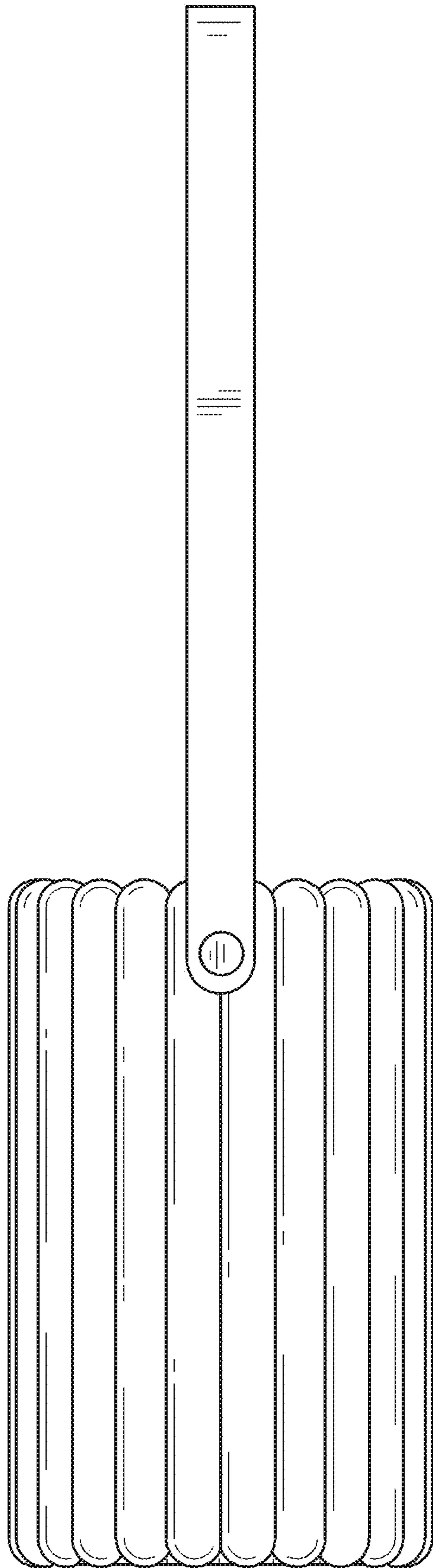

FIG. 86

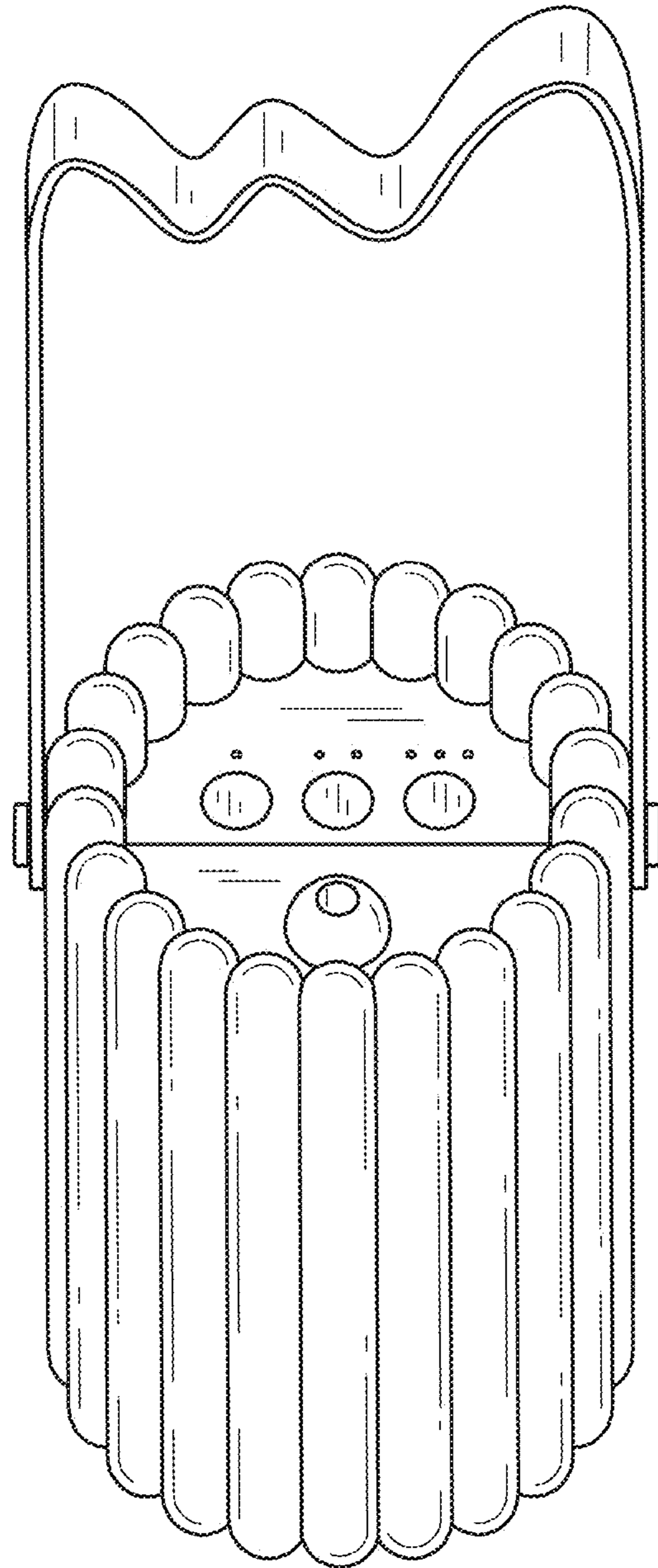

FIG. 87

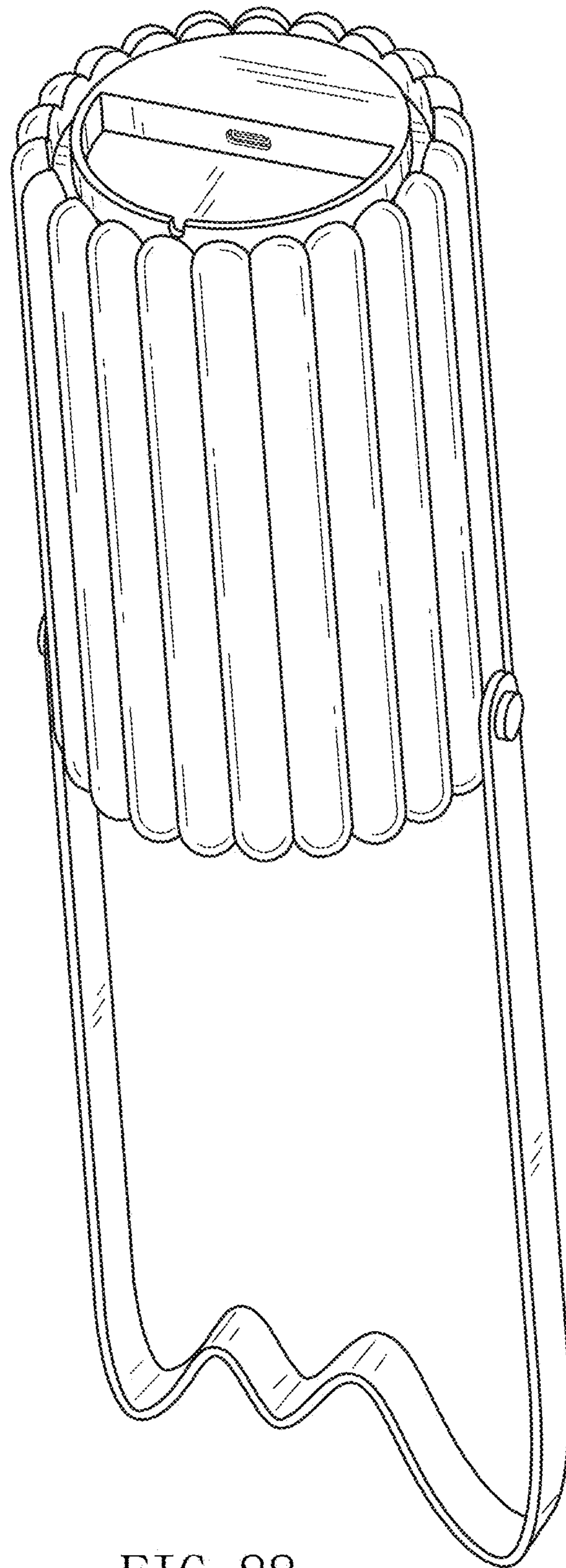

FIG. 88

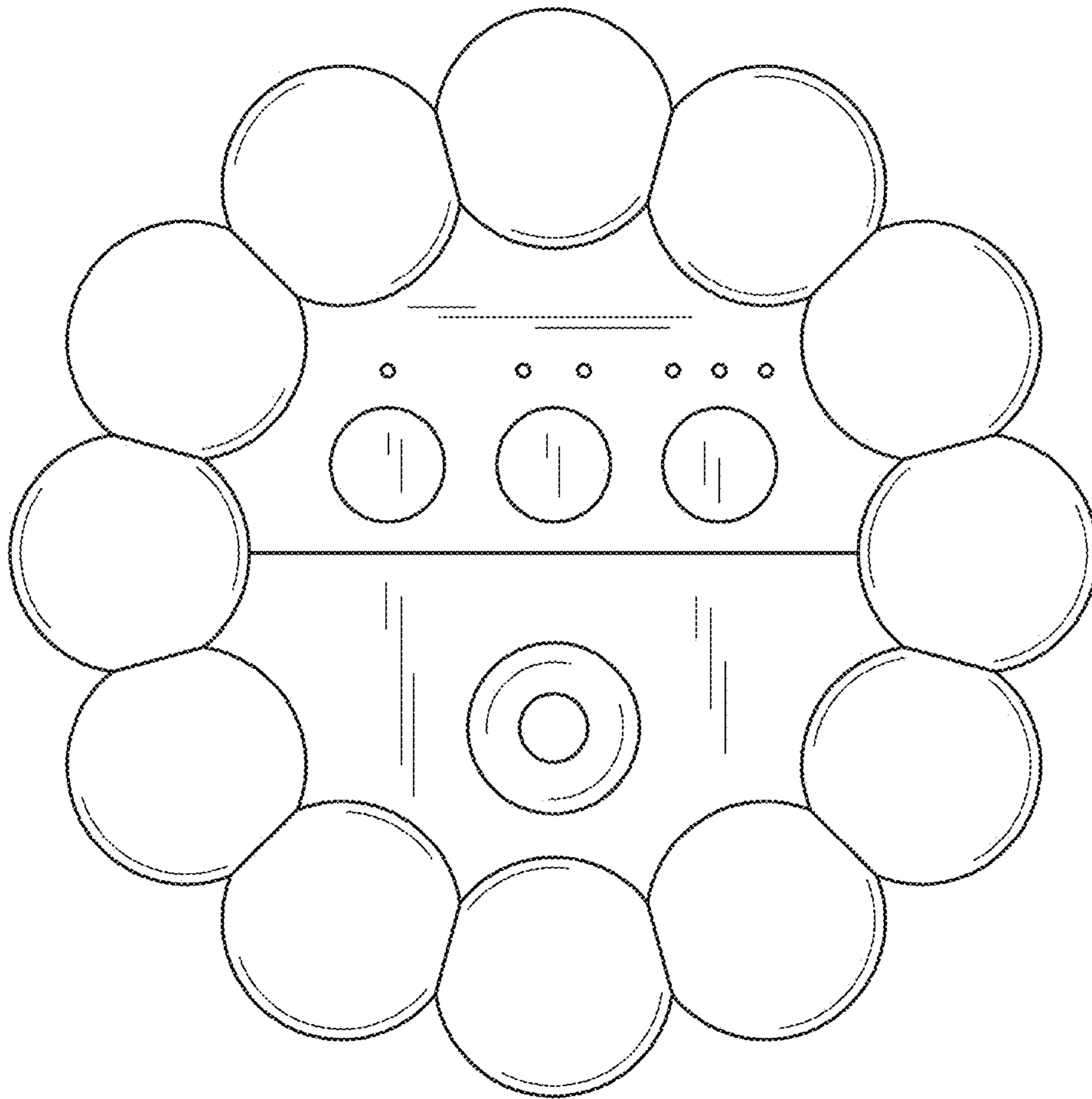

FIG. 89

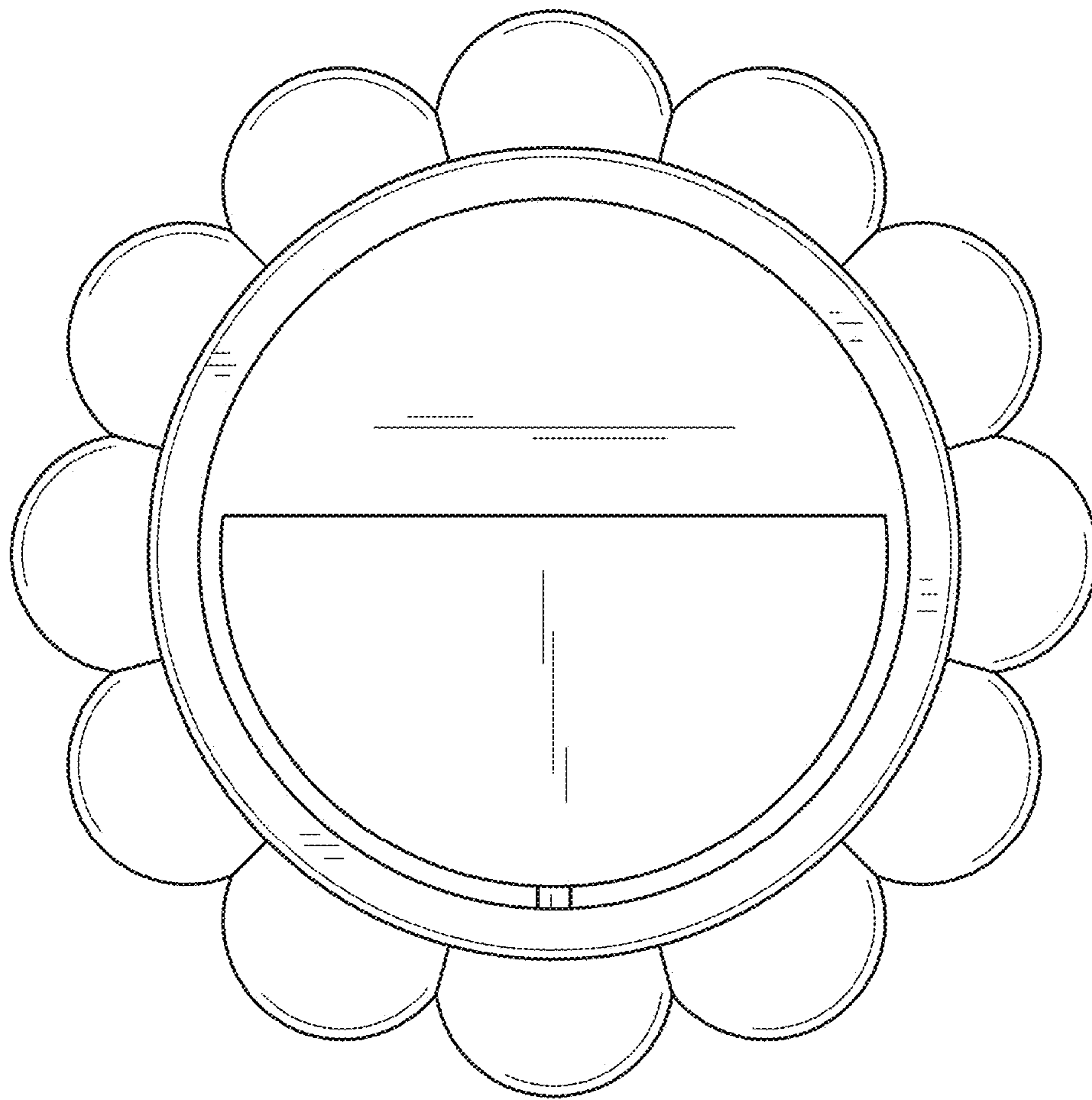

FIG. 90

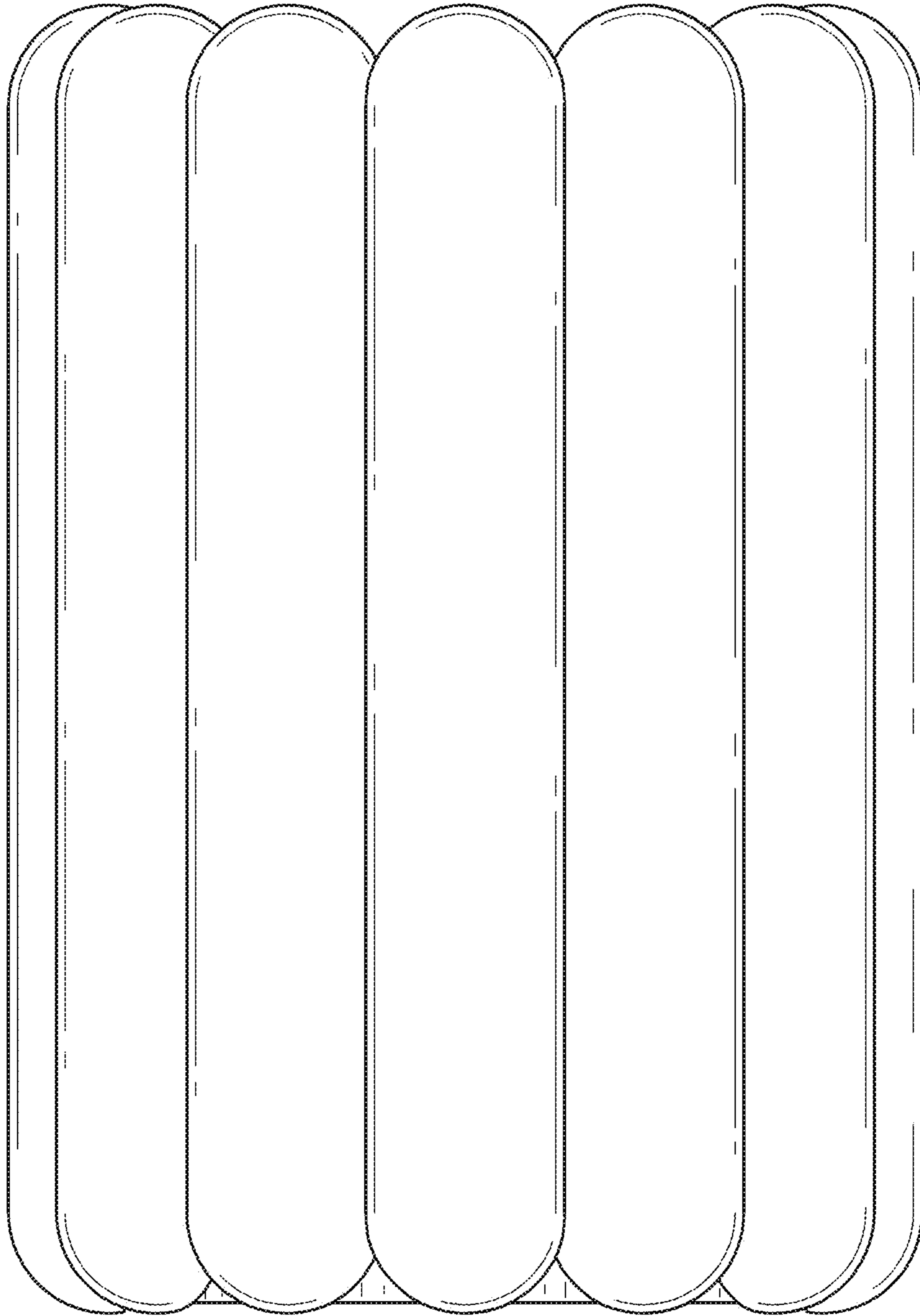

FIG. 91

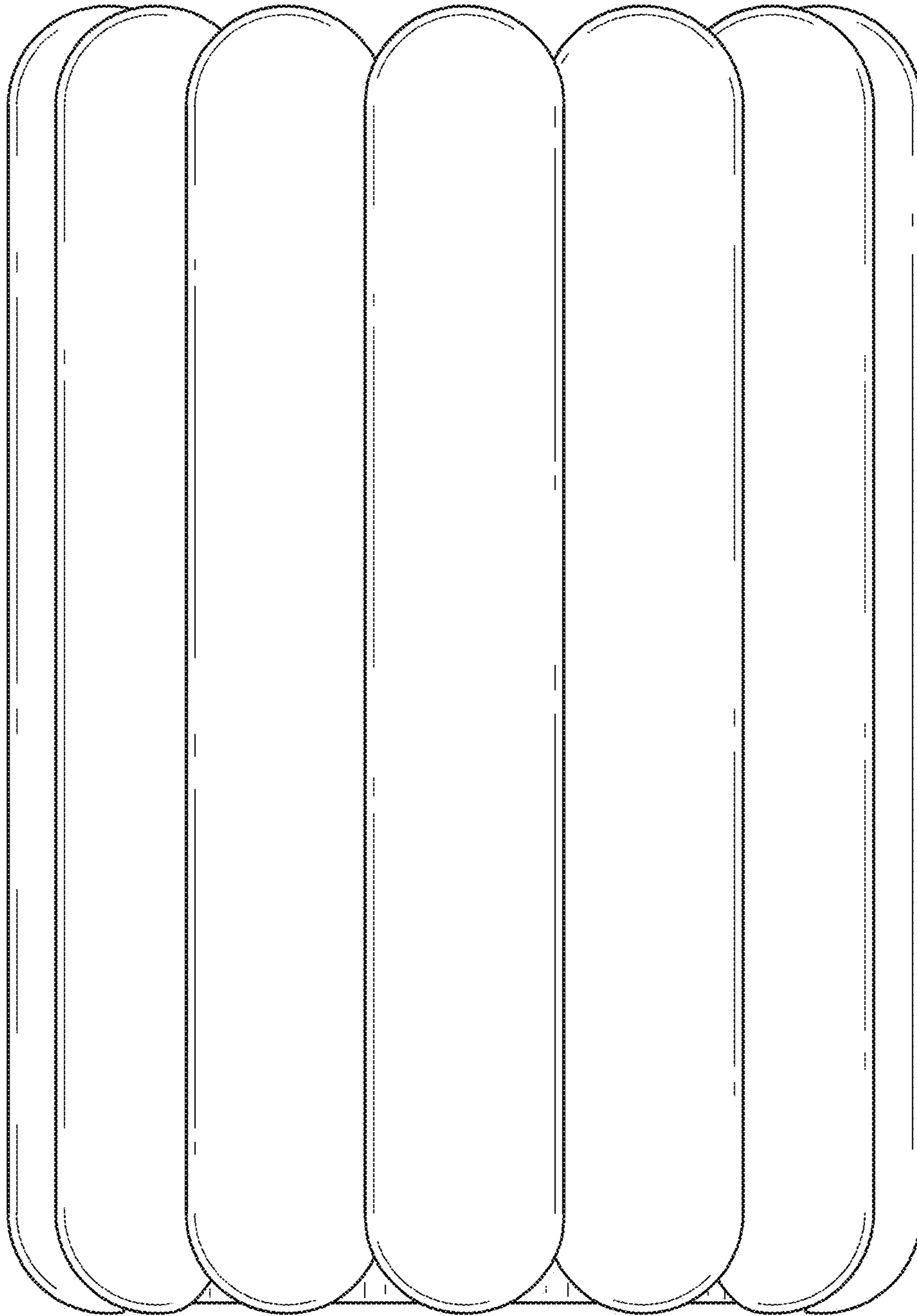

FIG. 92

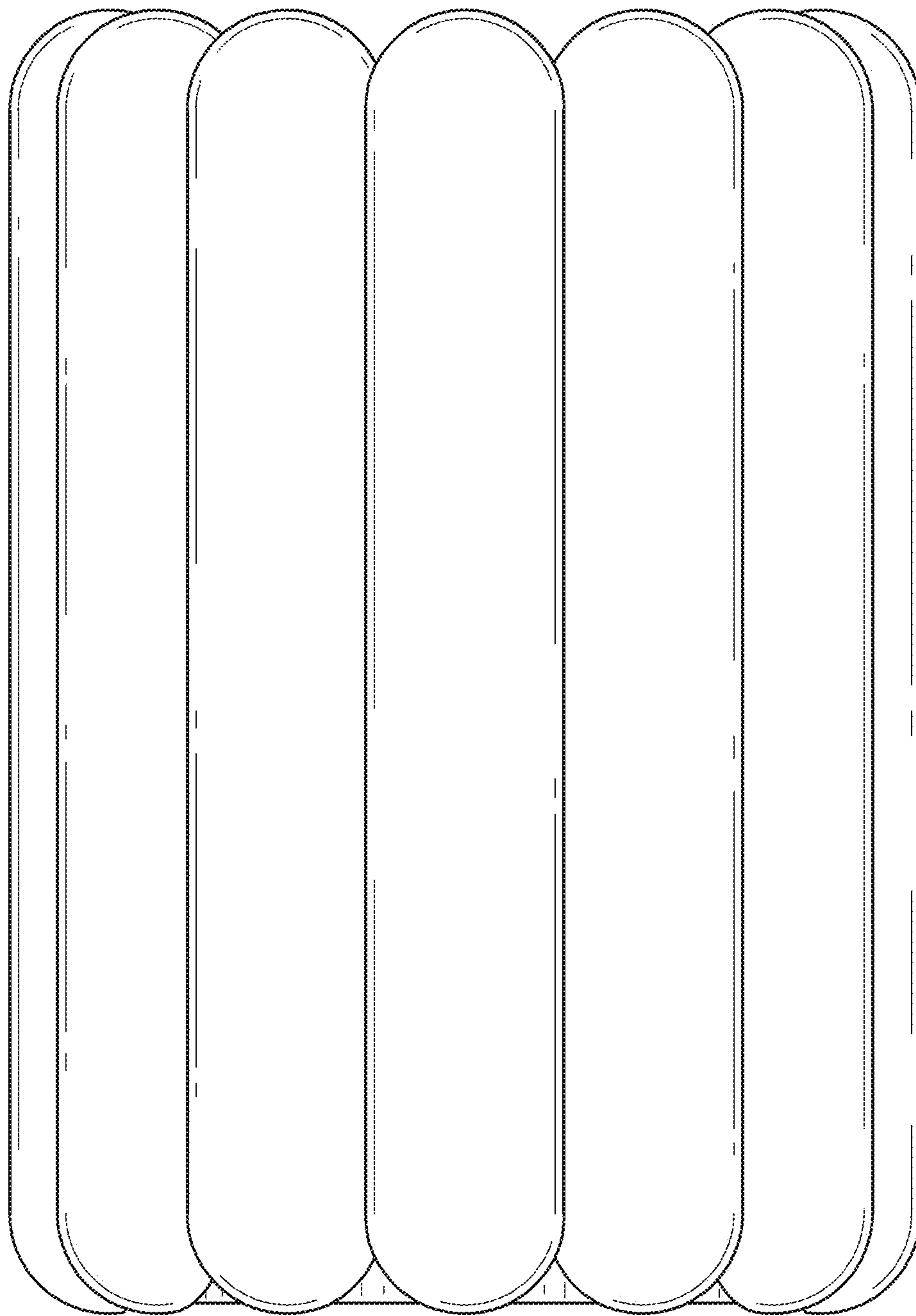

FIG. 93

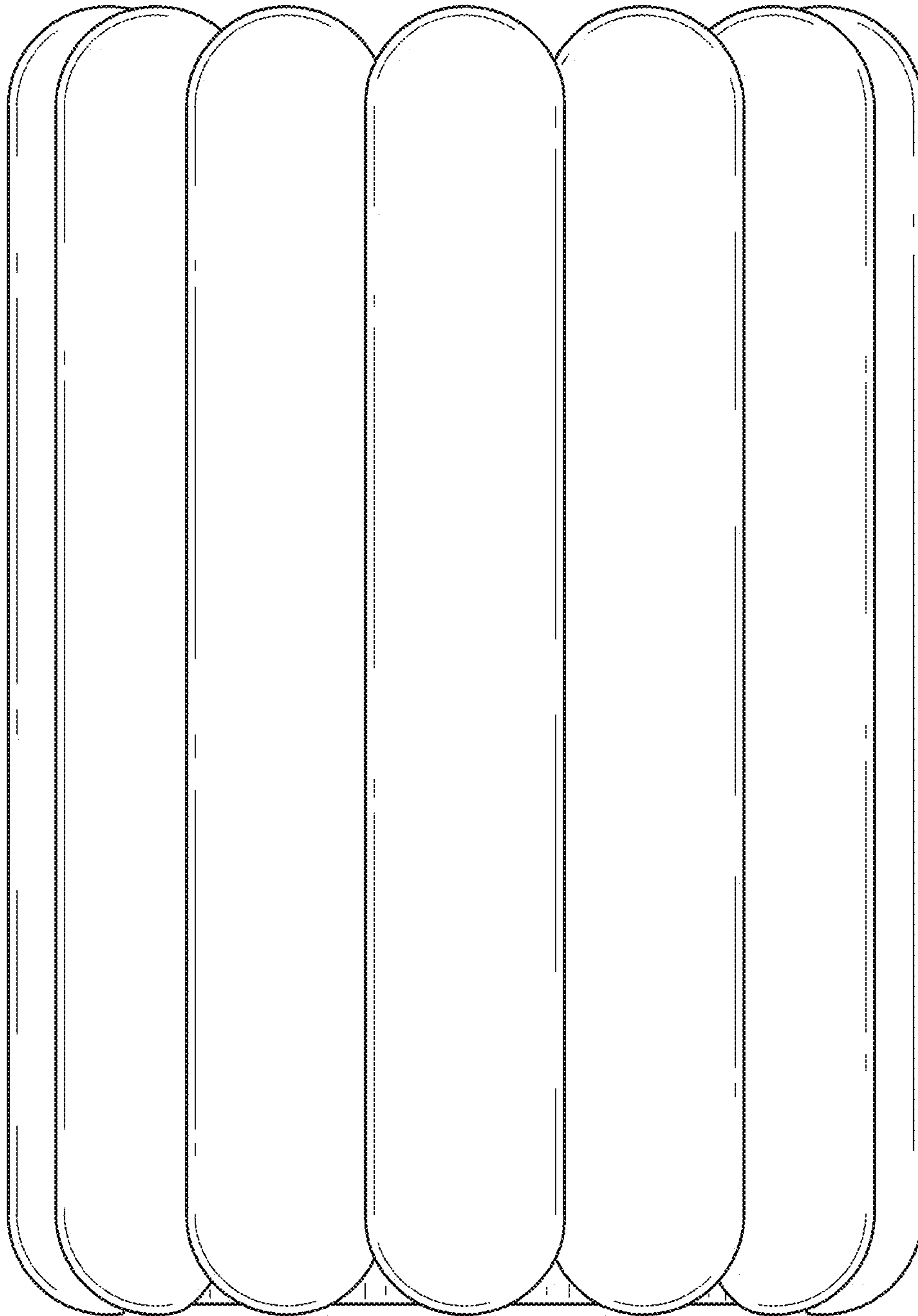

FIG. 94

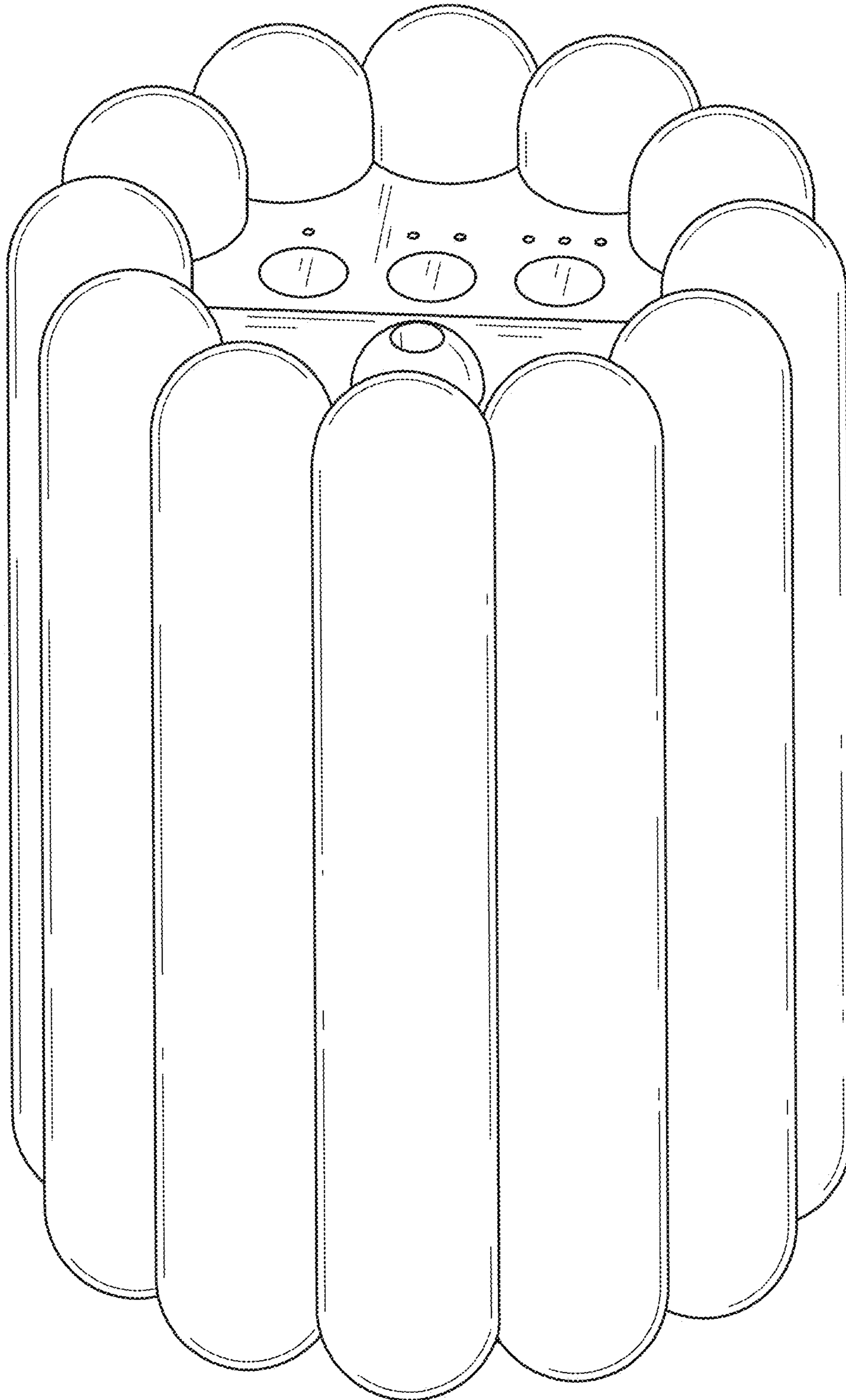

FIG. 95



FIG. 96

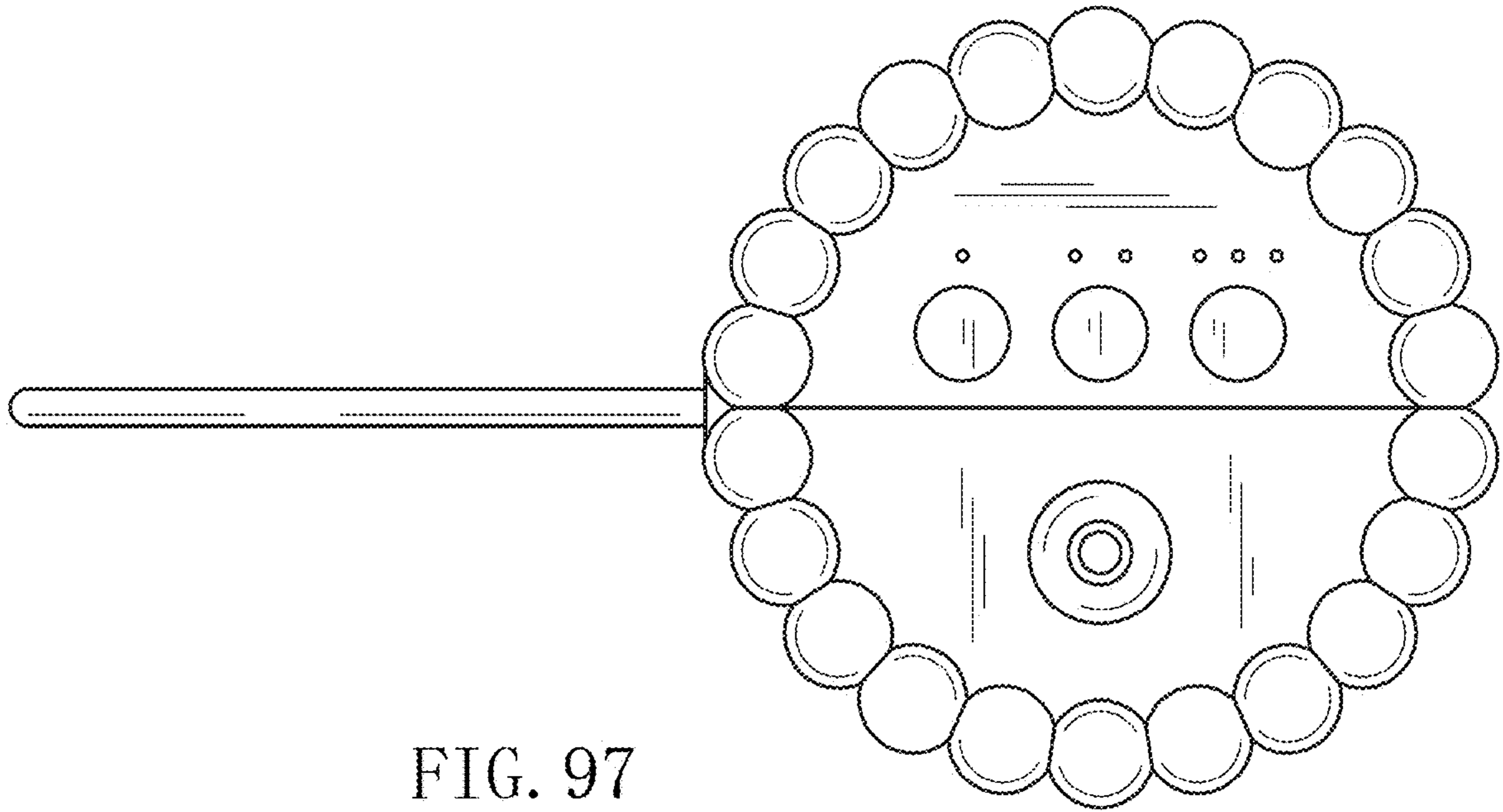

FIG. 97

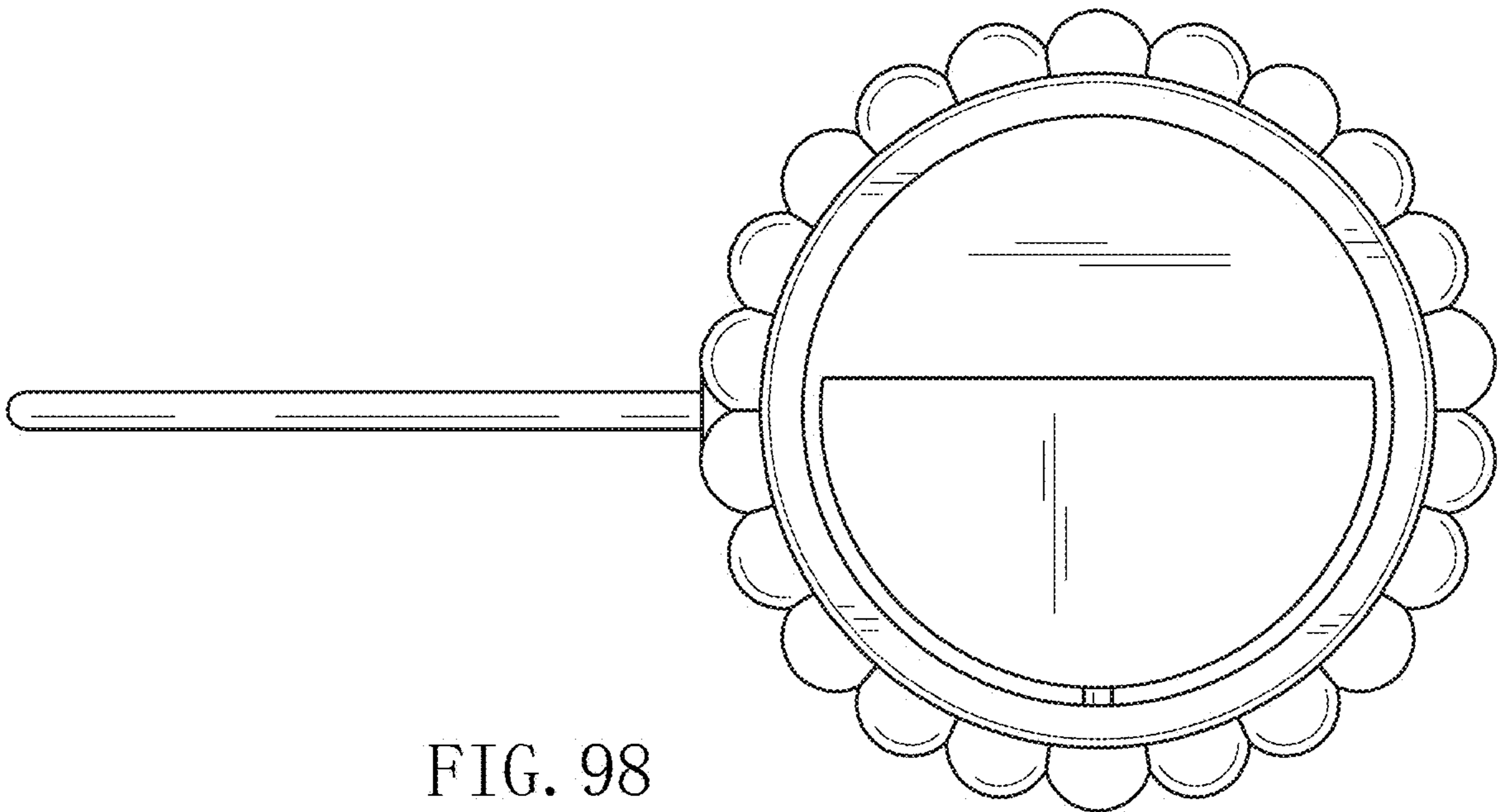

FIG. 98

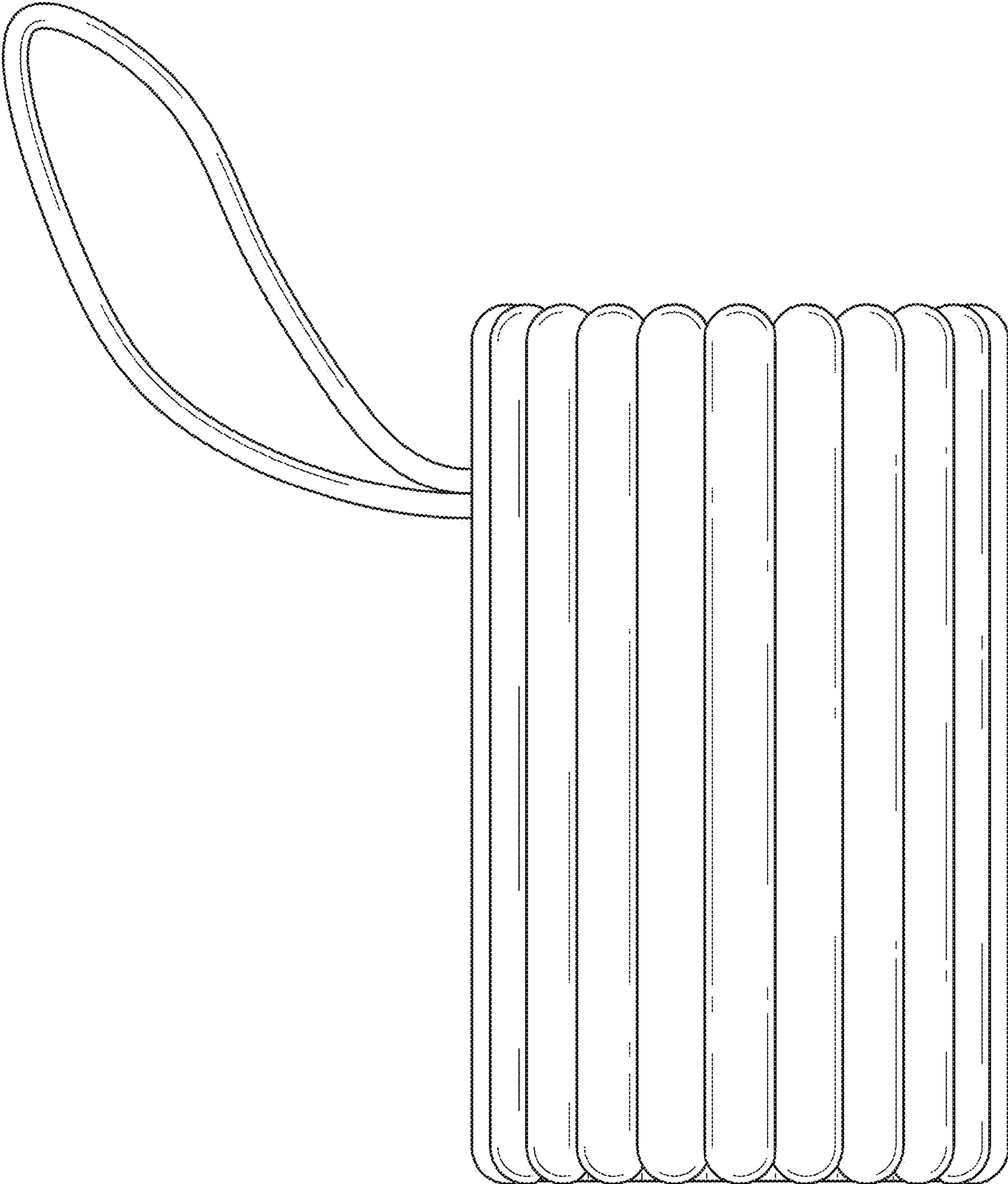

FIG. 99

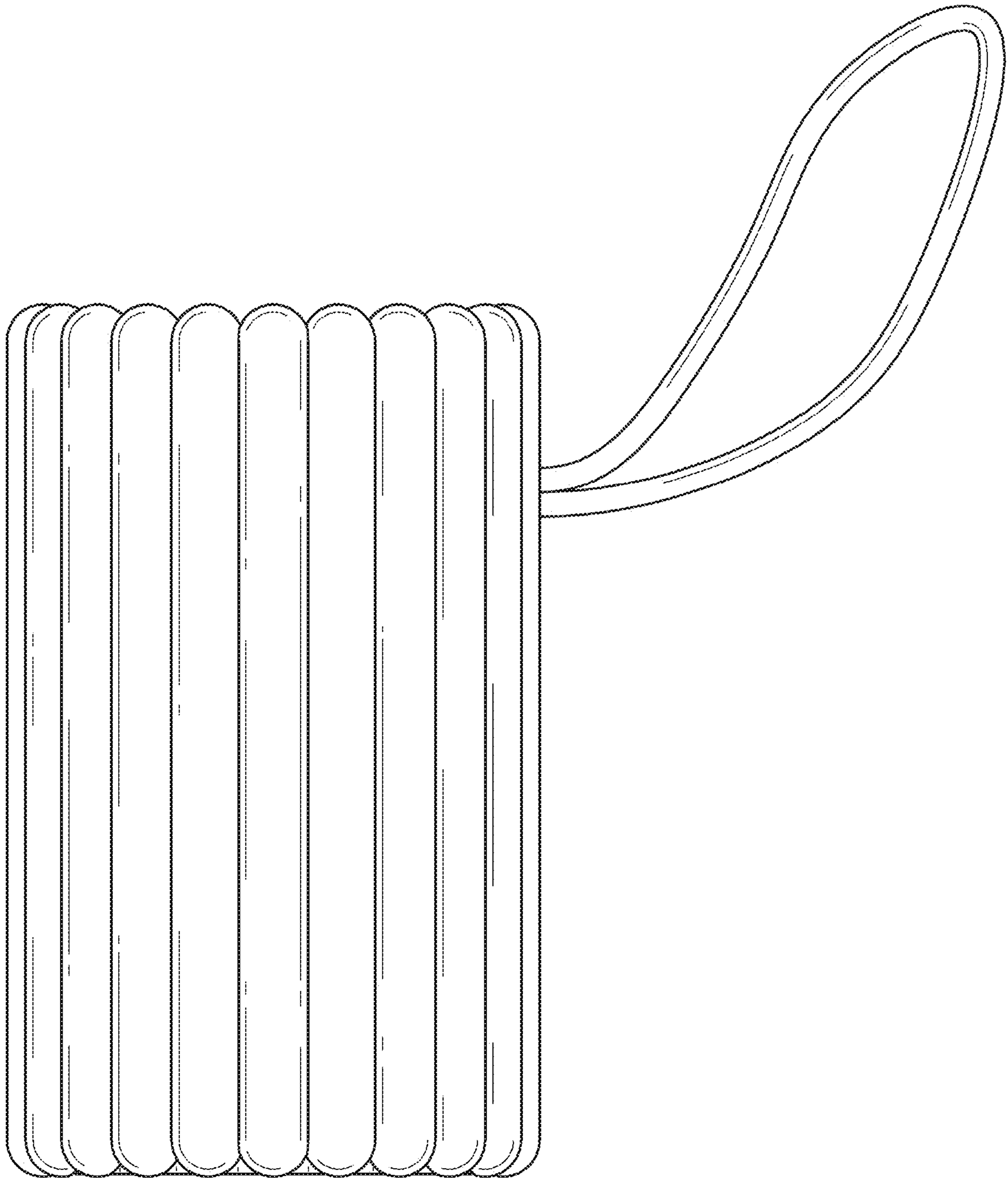

FIG. 100

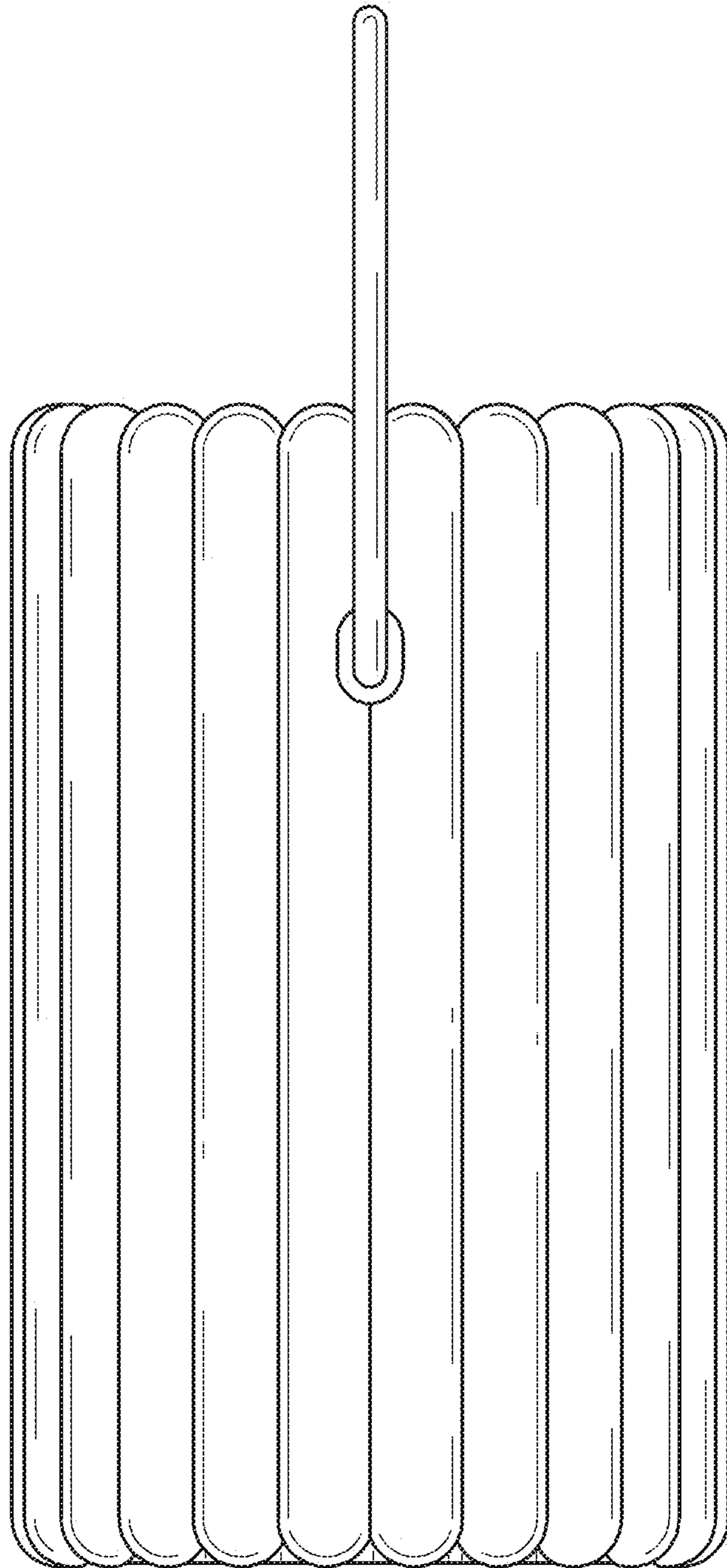

FIG. 101

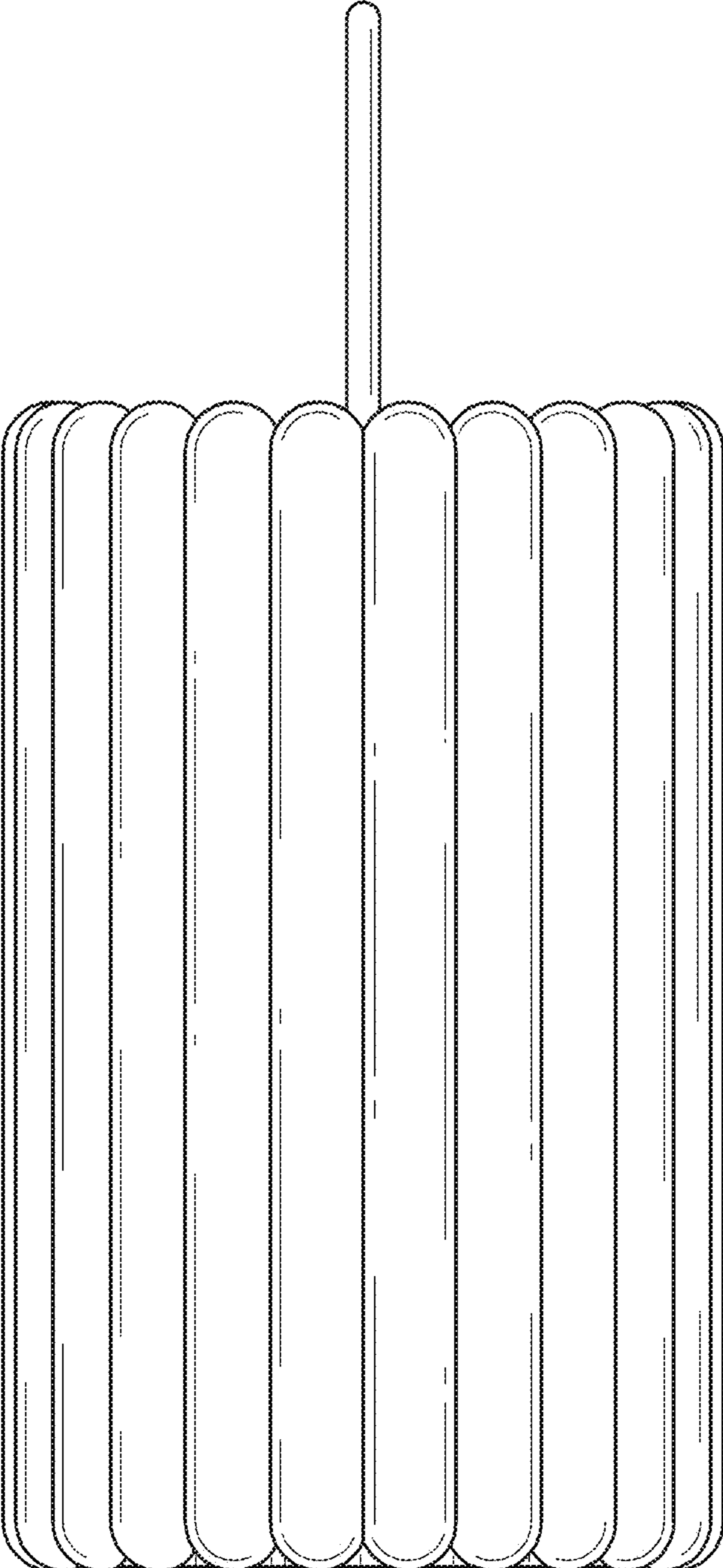

FIG. 102

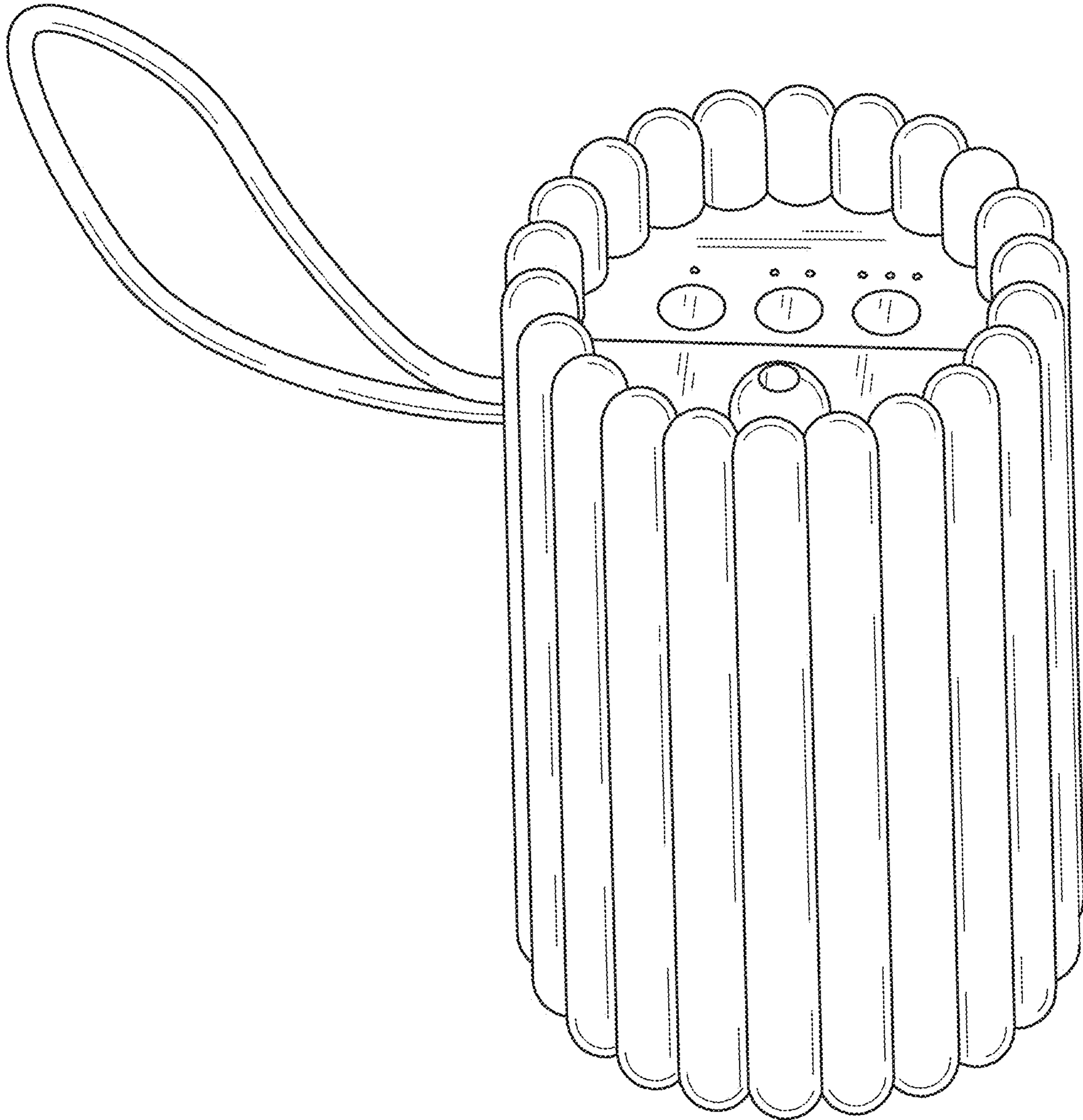

FIG. 103

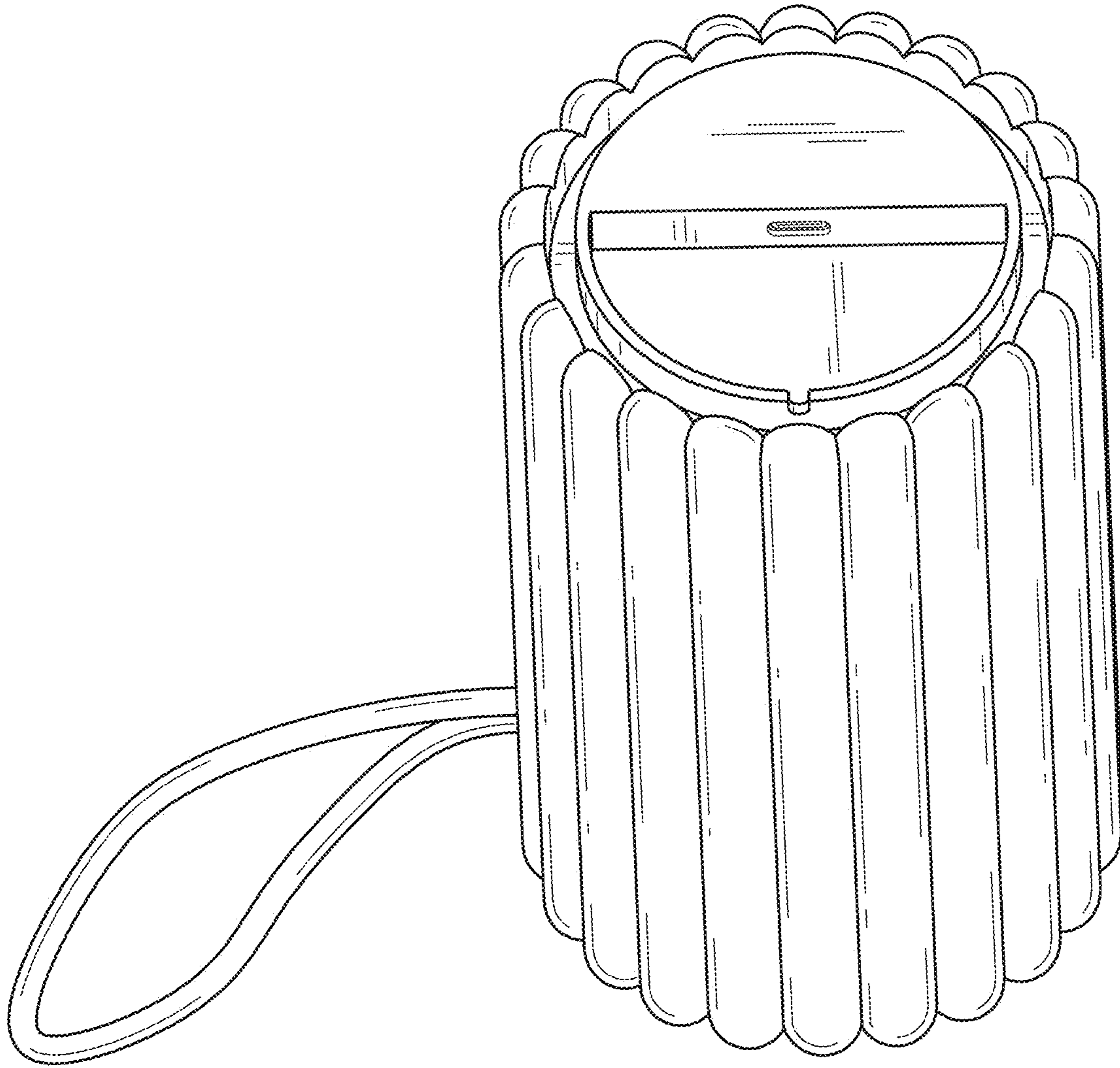

FIG. 104

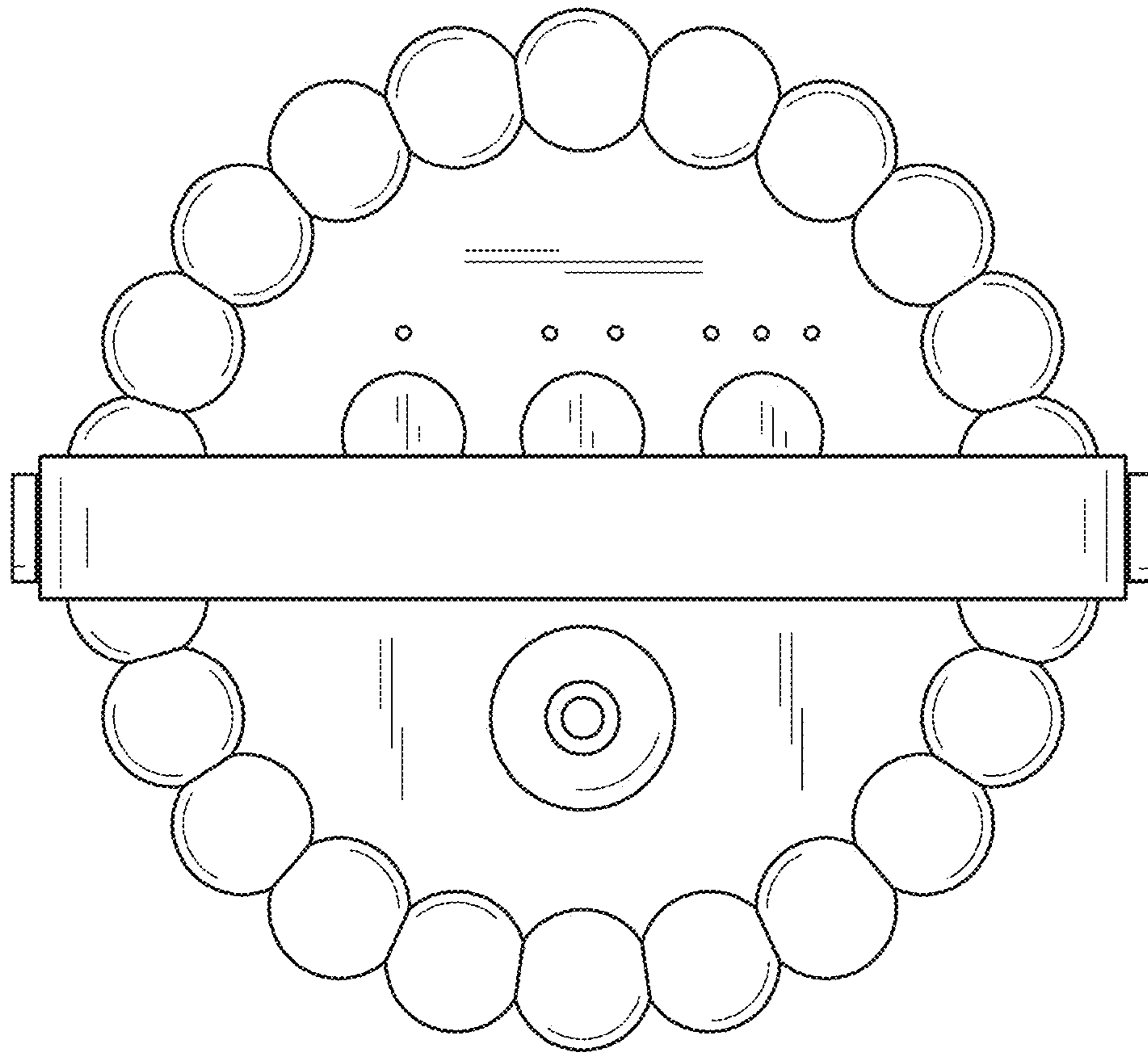

FIG. 105

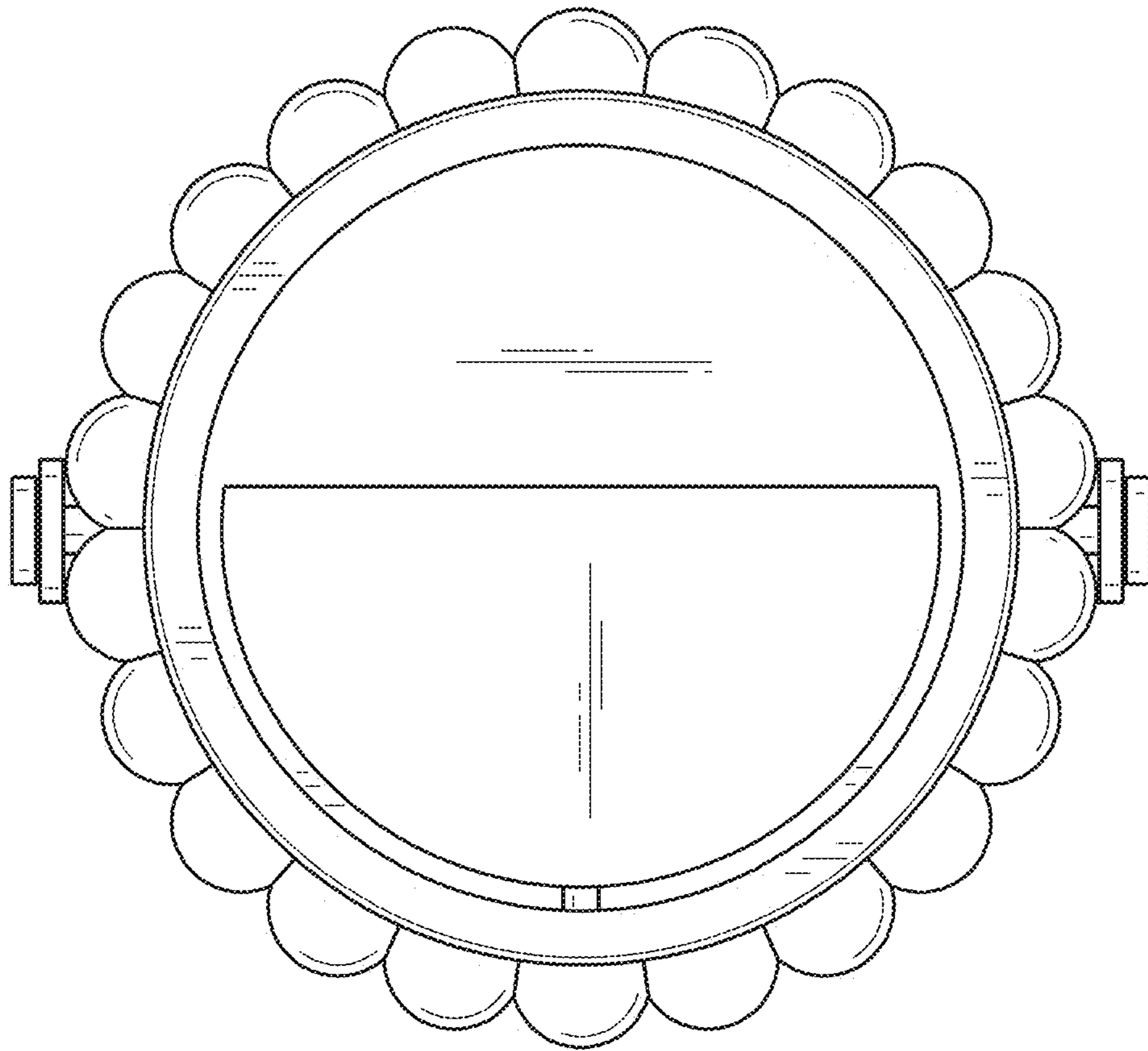

FIG. 106

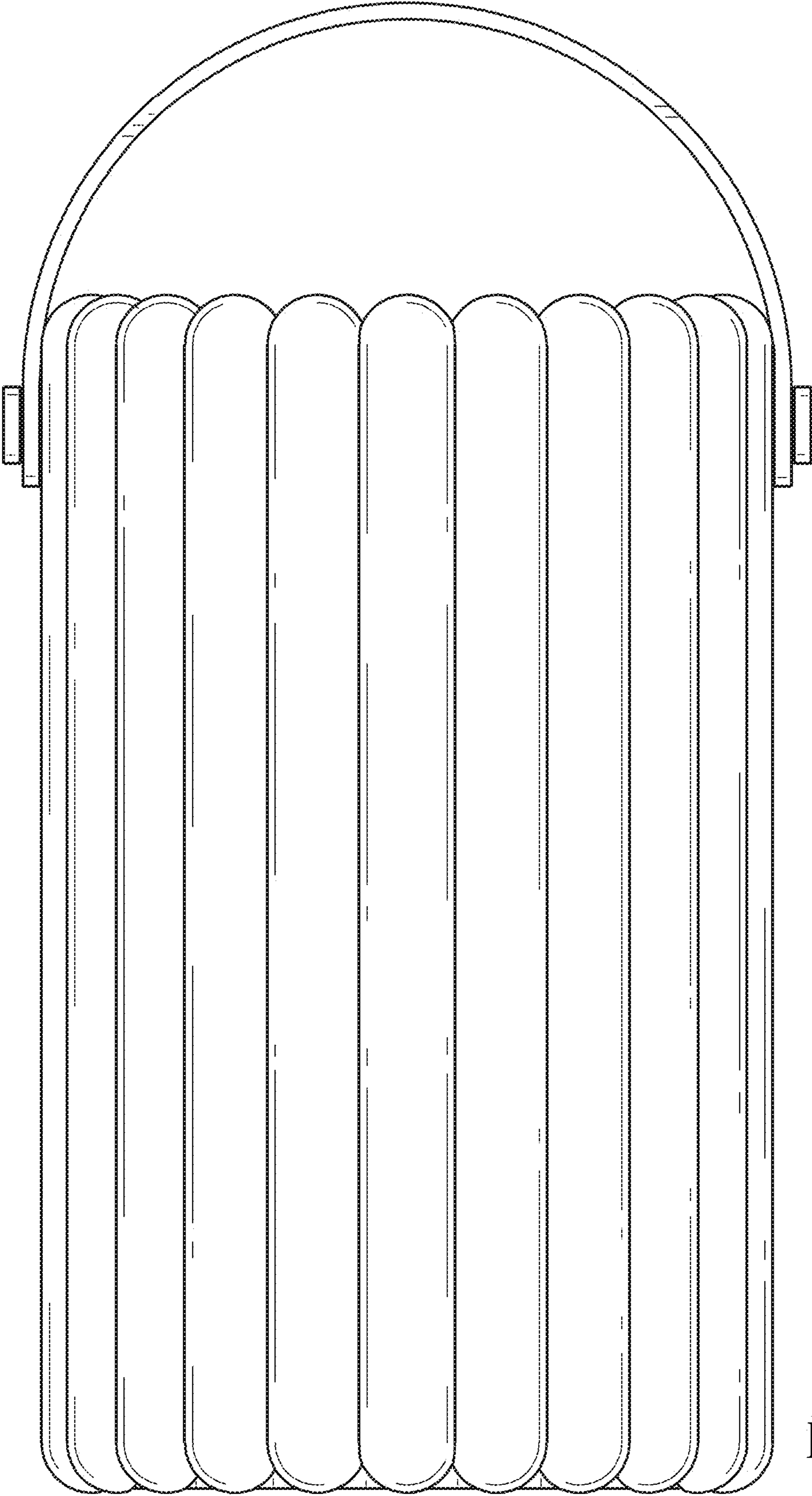

FIG. 107

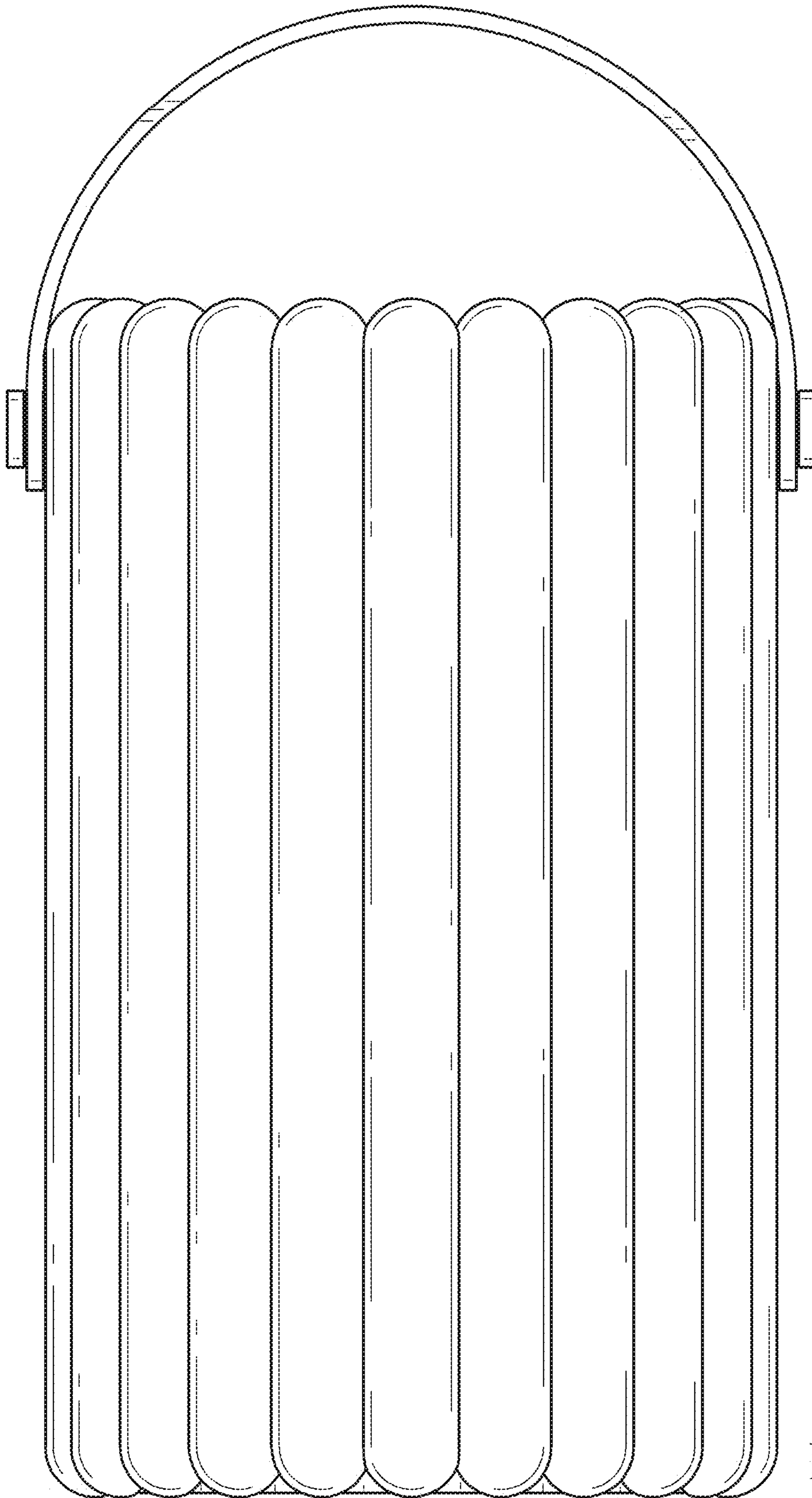

FIG. 108

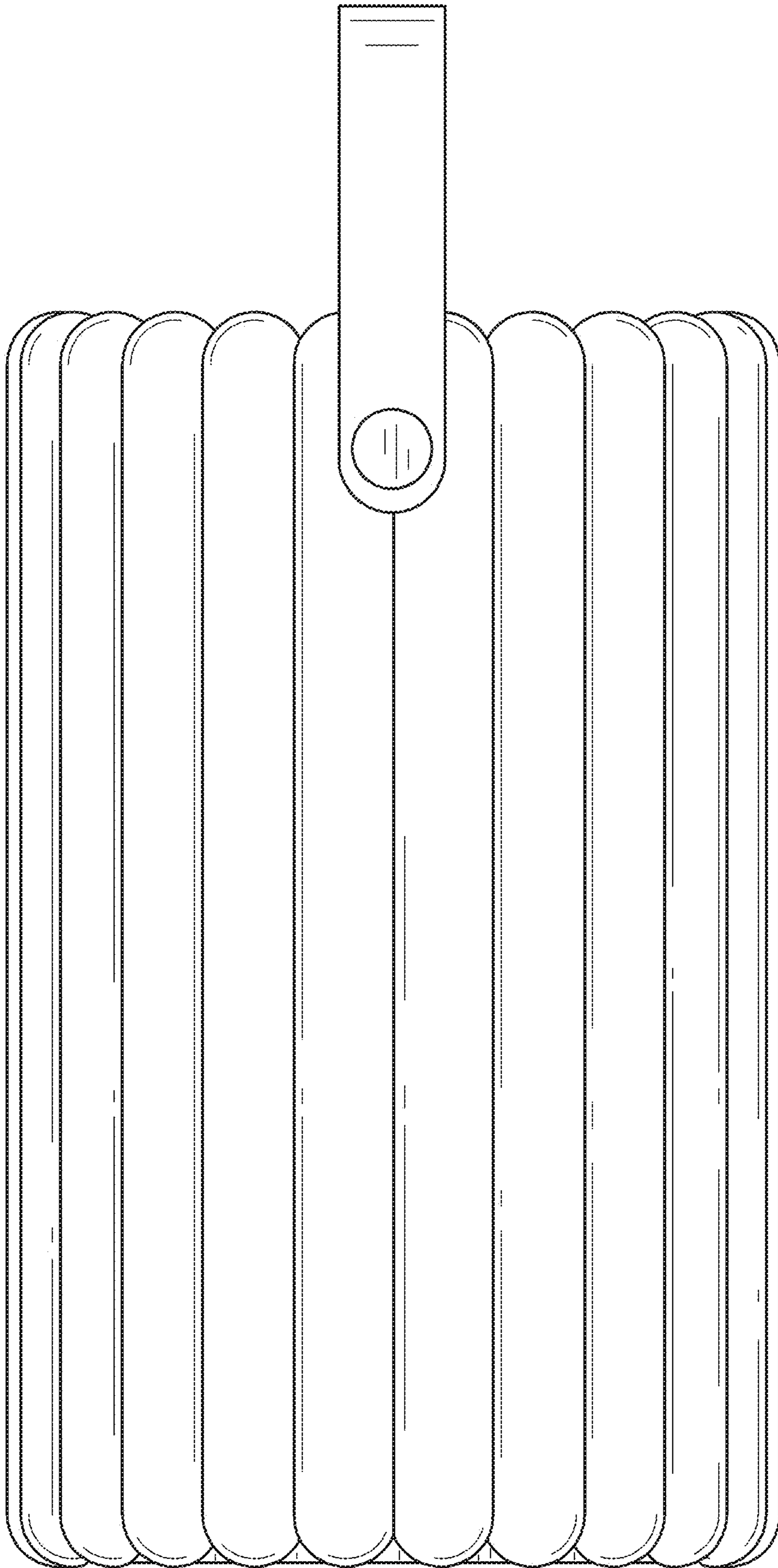

FIG. 109

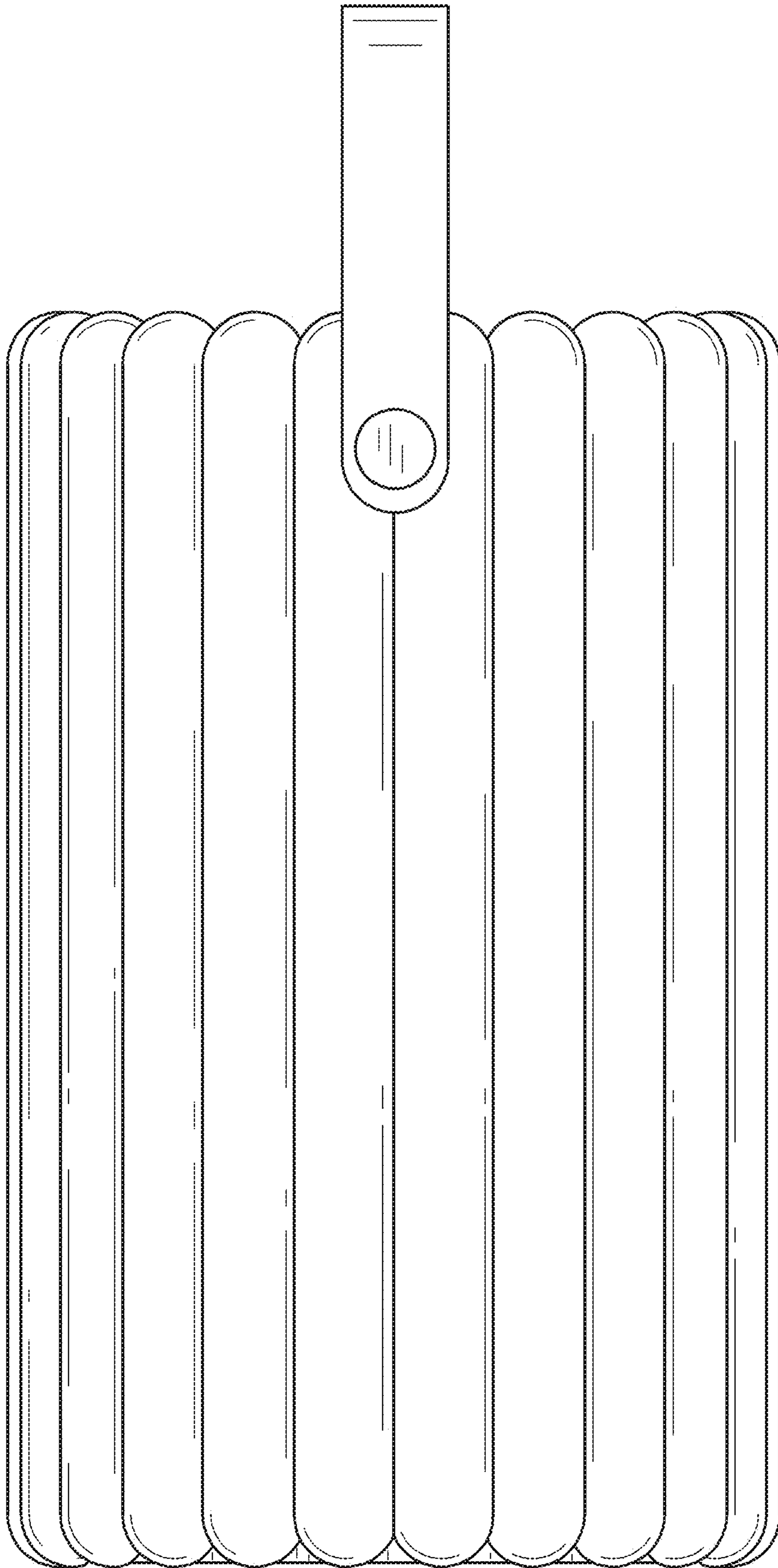

FIG. 110

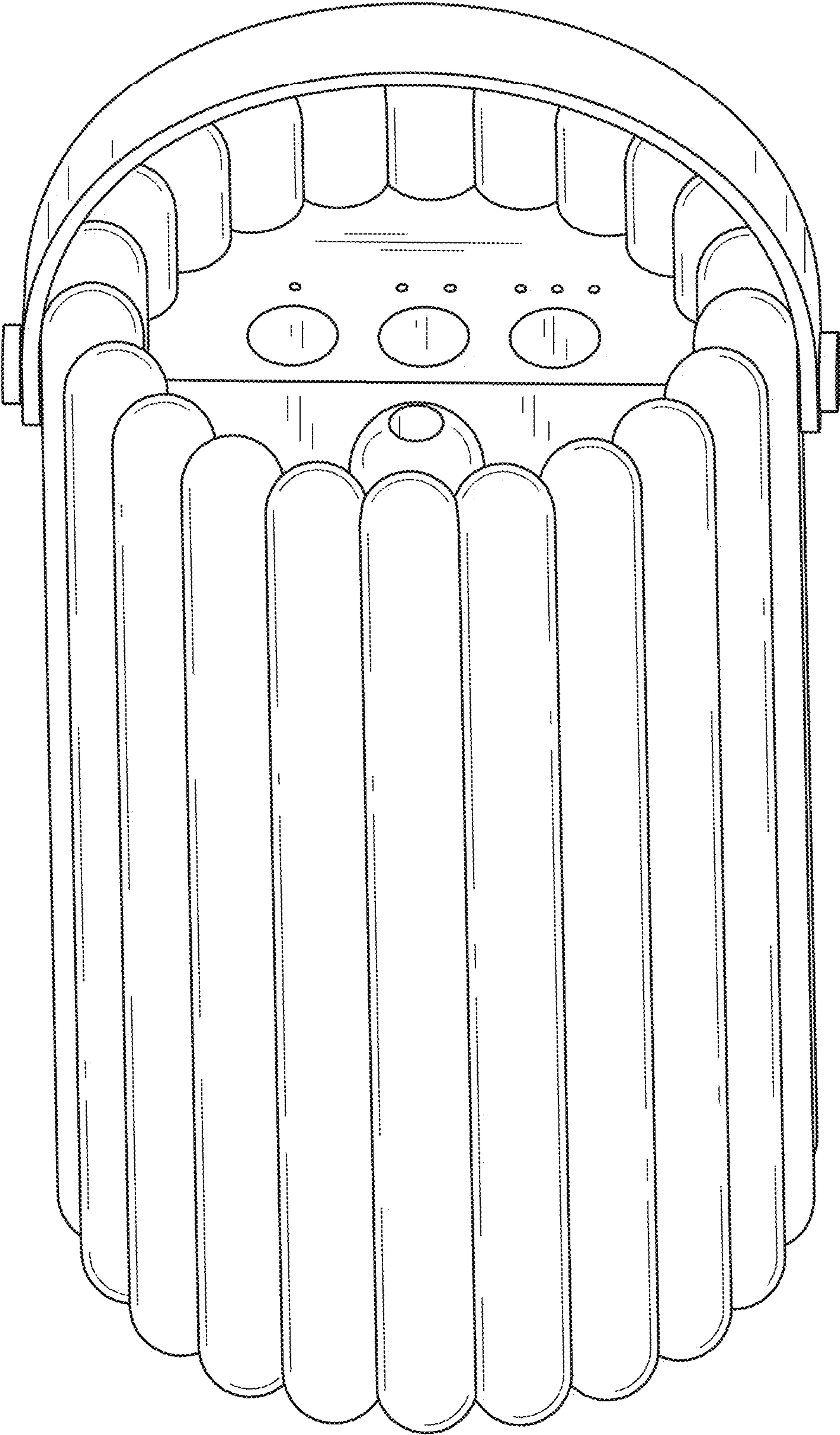

FIG. 111

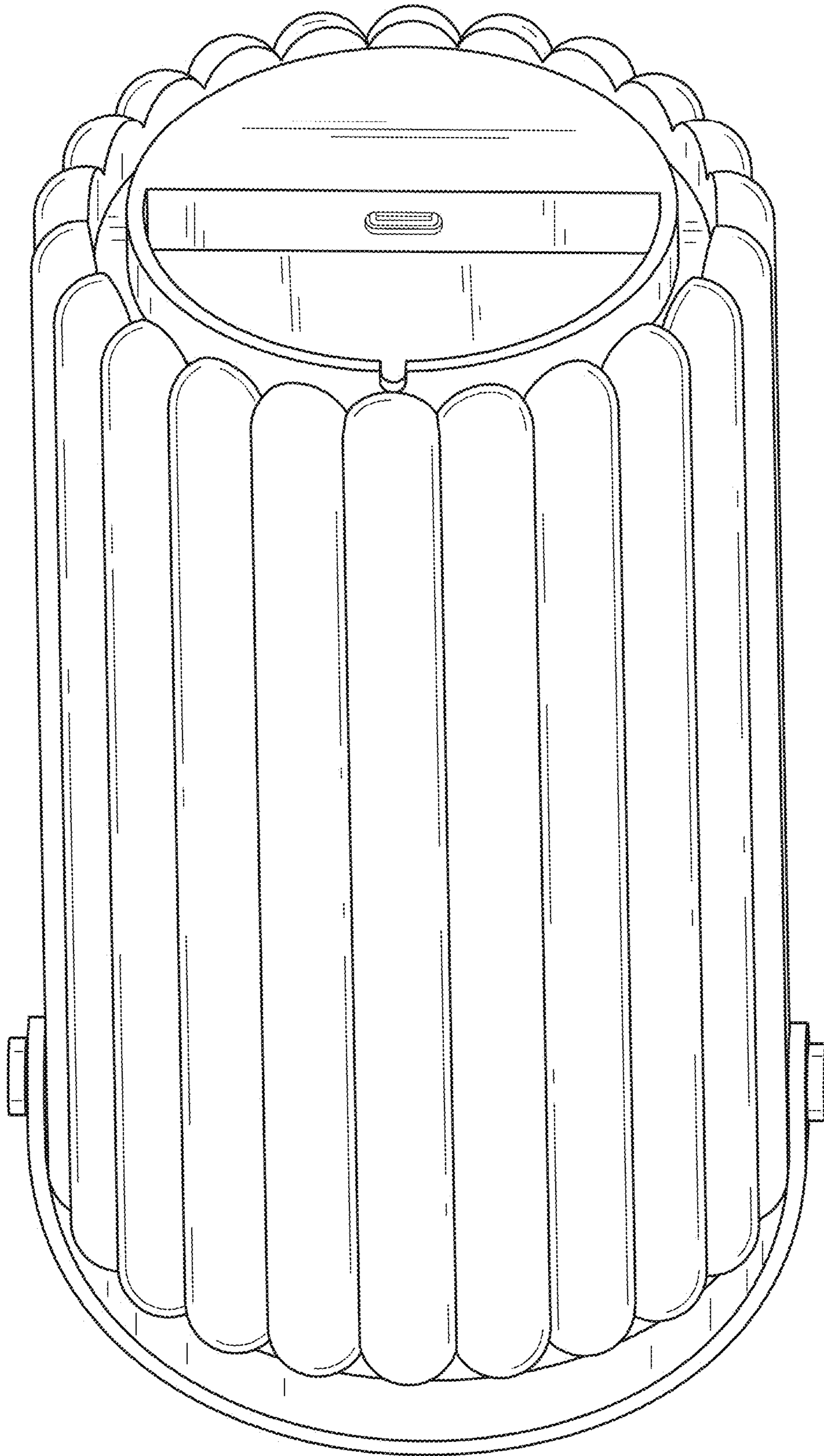

FIG. 112

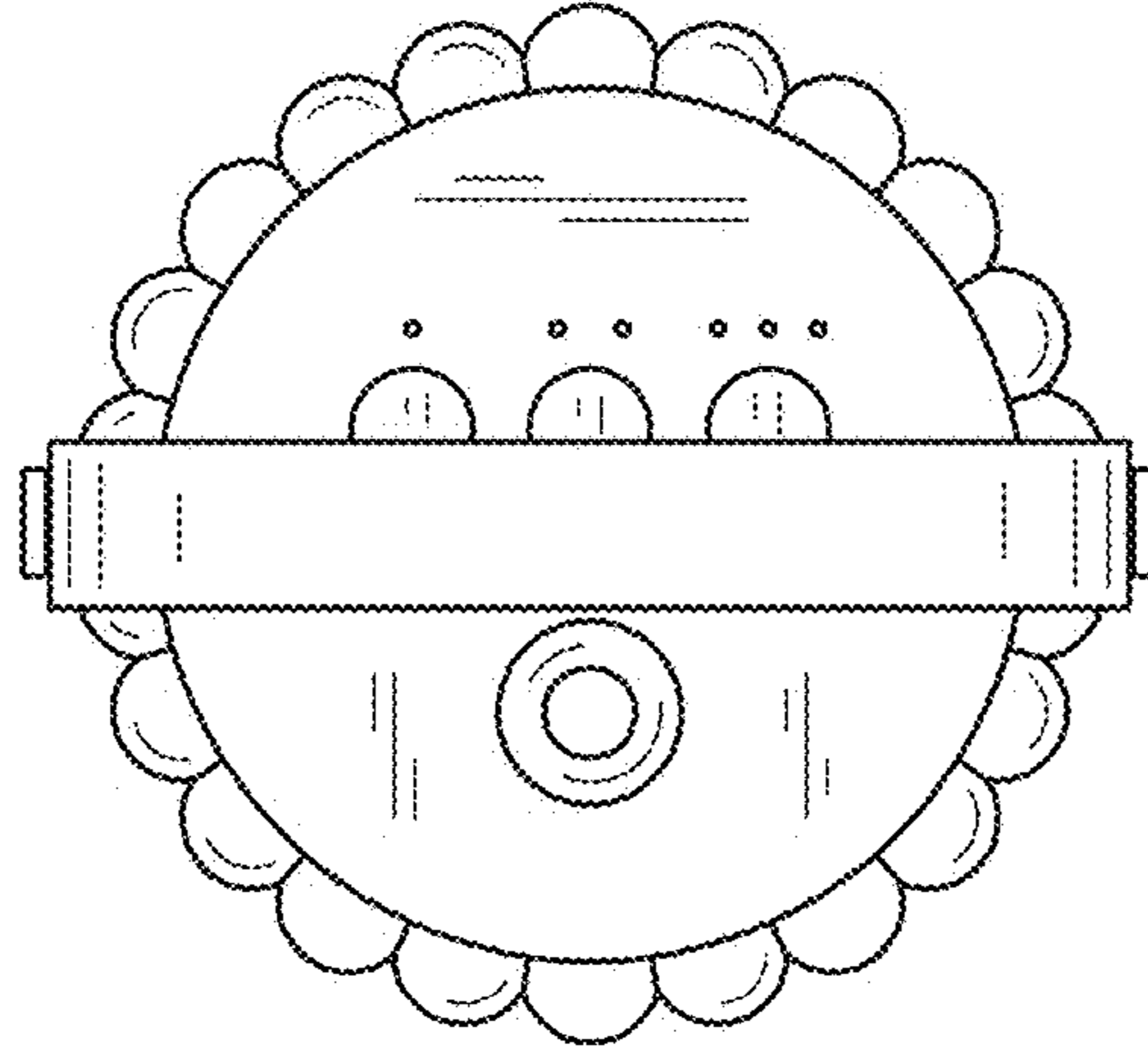

FIG. 113

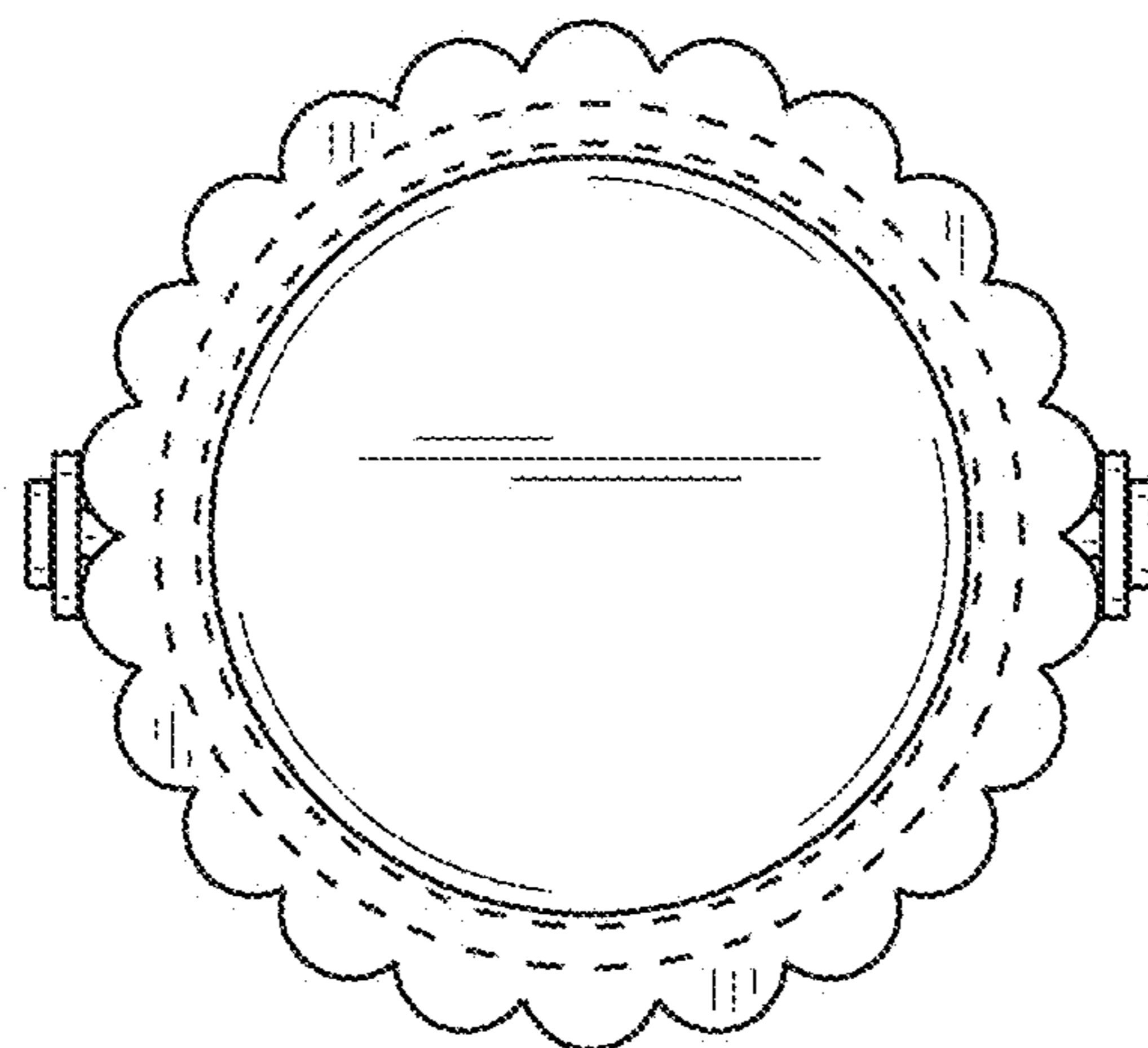

FIG. 114

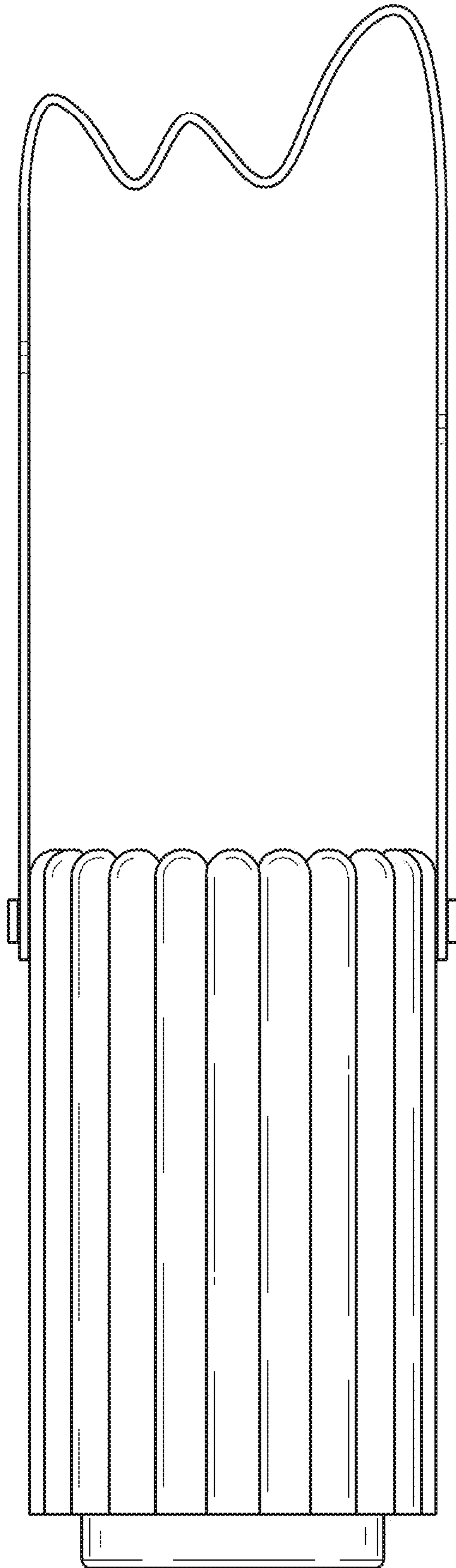

FIG. 115

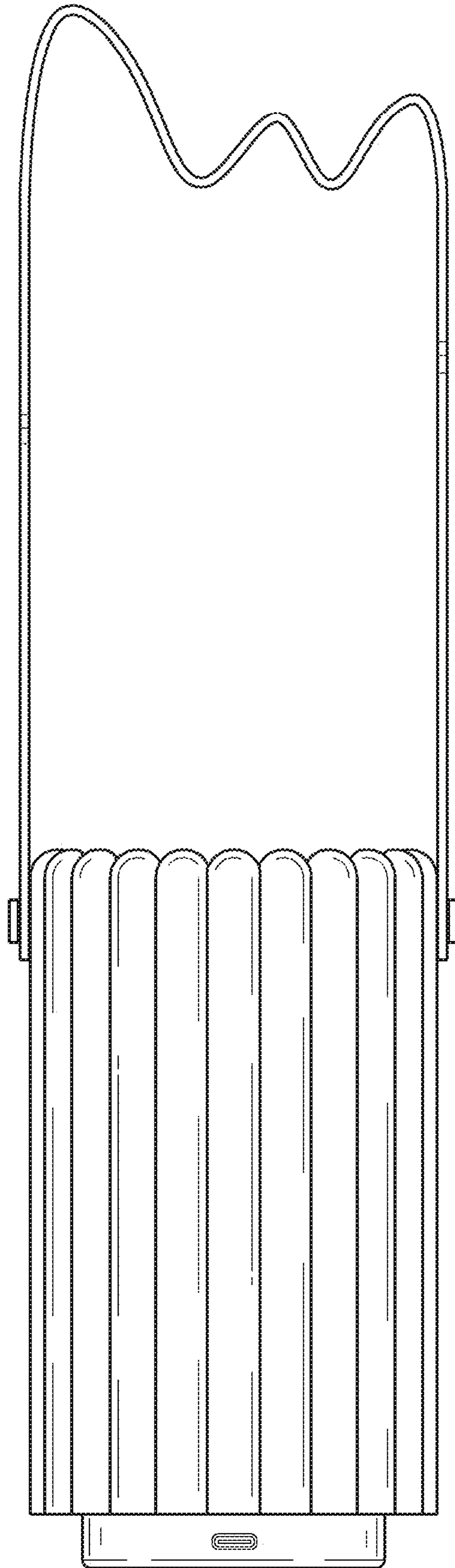

FIG. 116

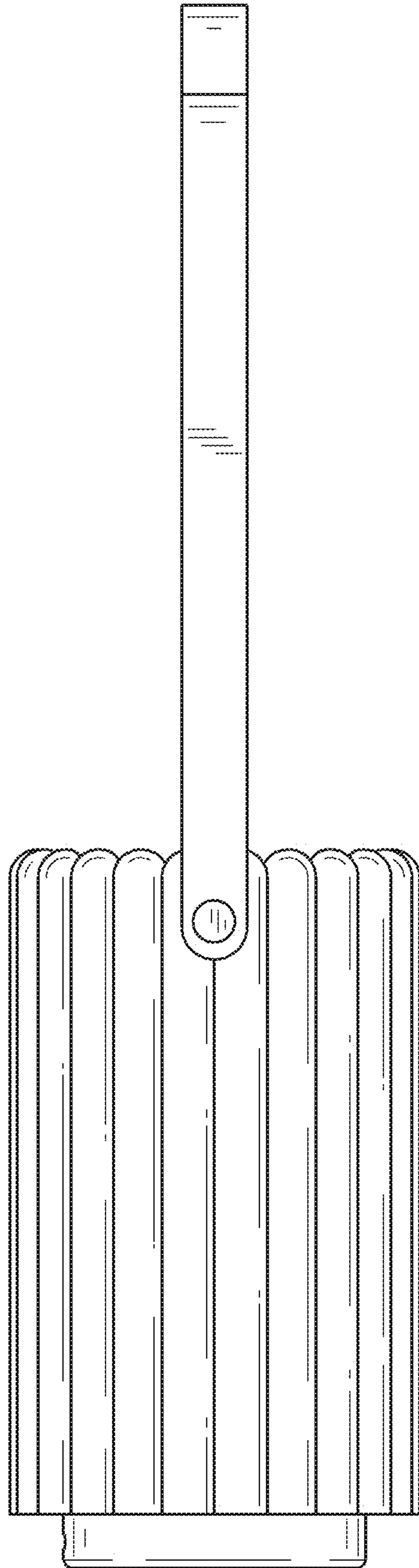

FIG. 117

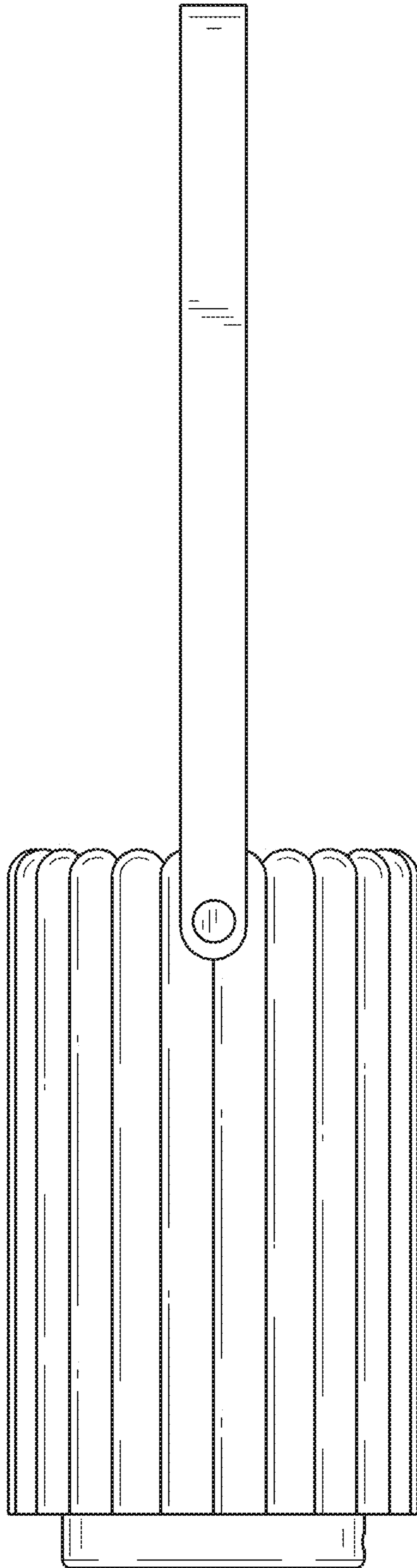

FIG. 118

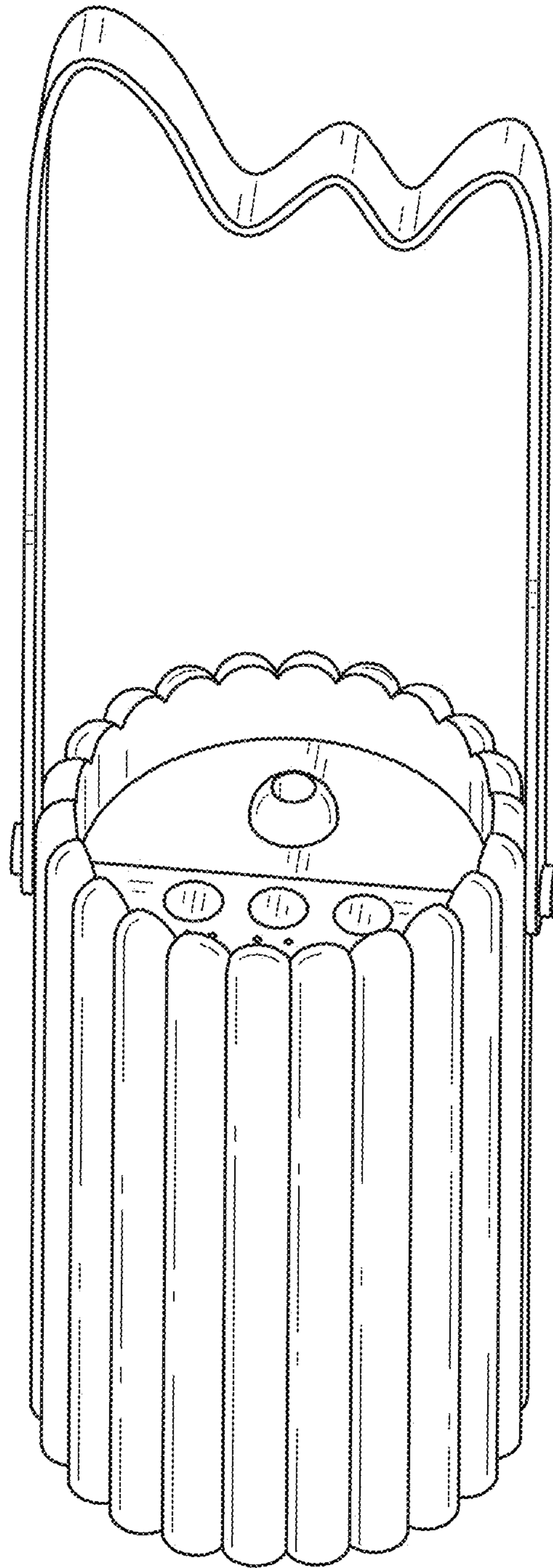

FIG. 119

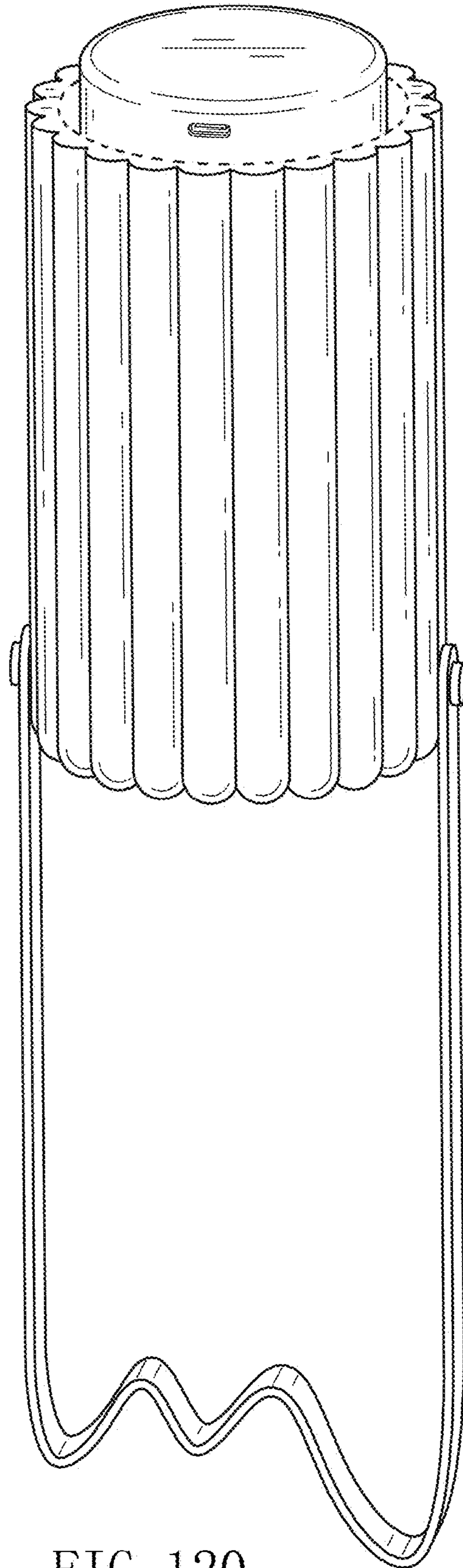

FIG. 120

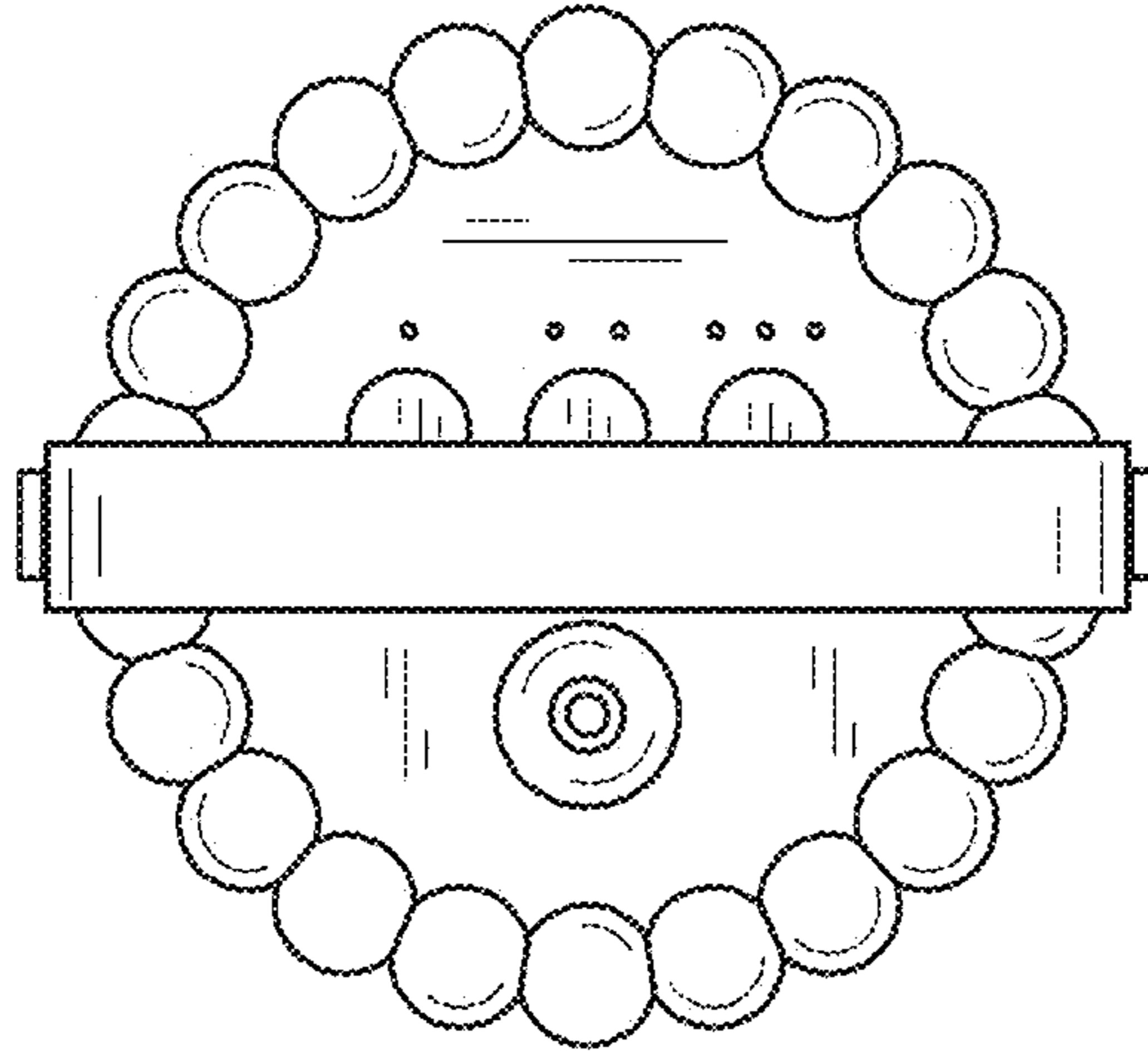

FIG. 121

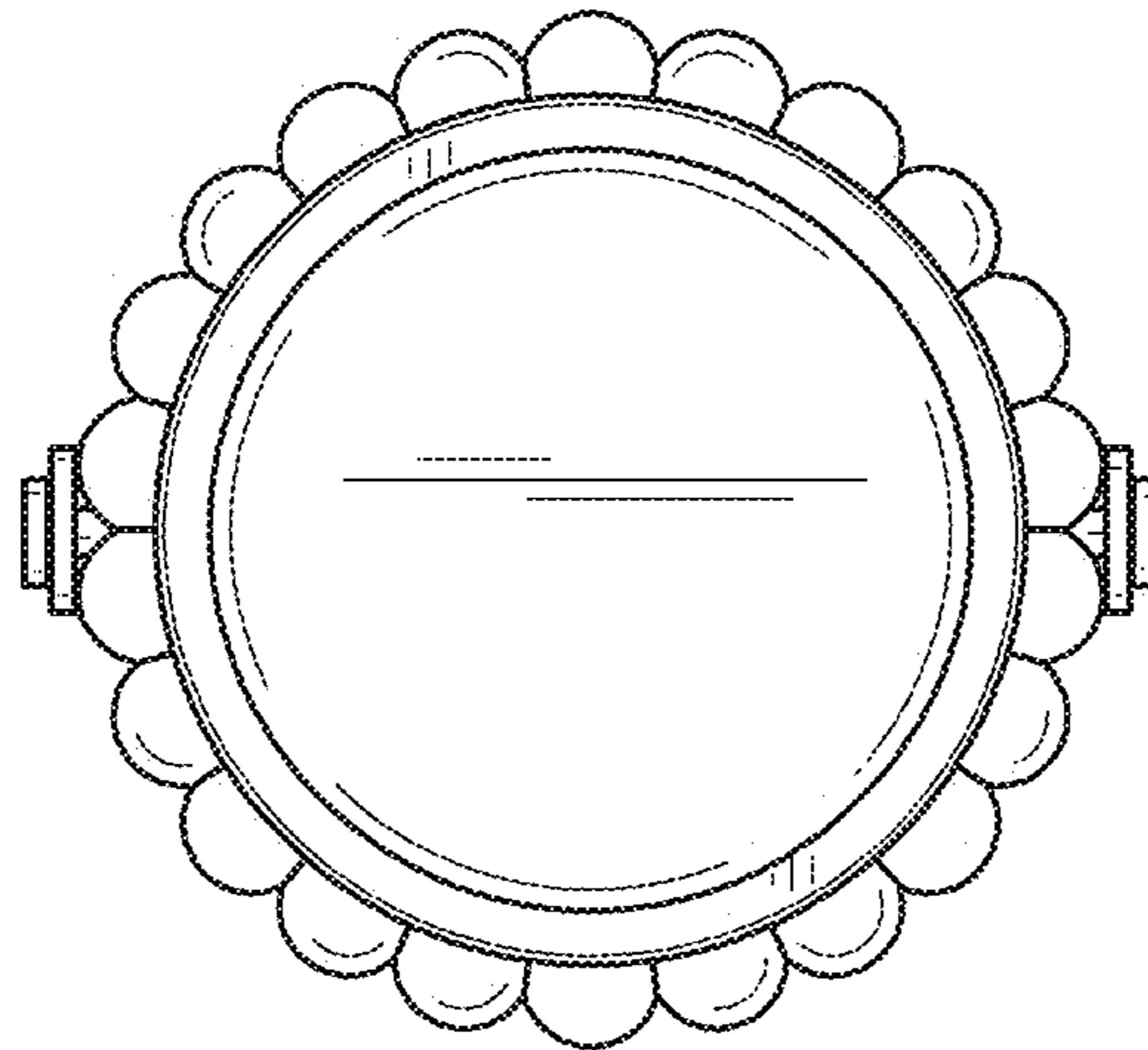

FIG. 122

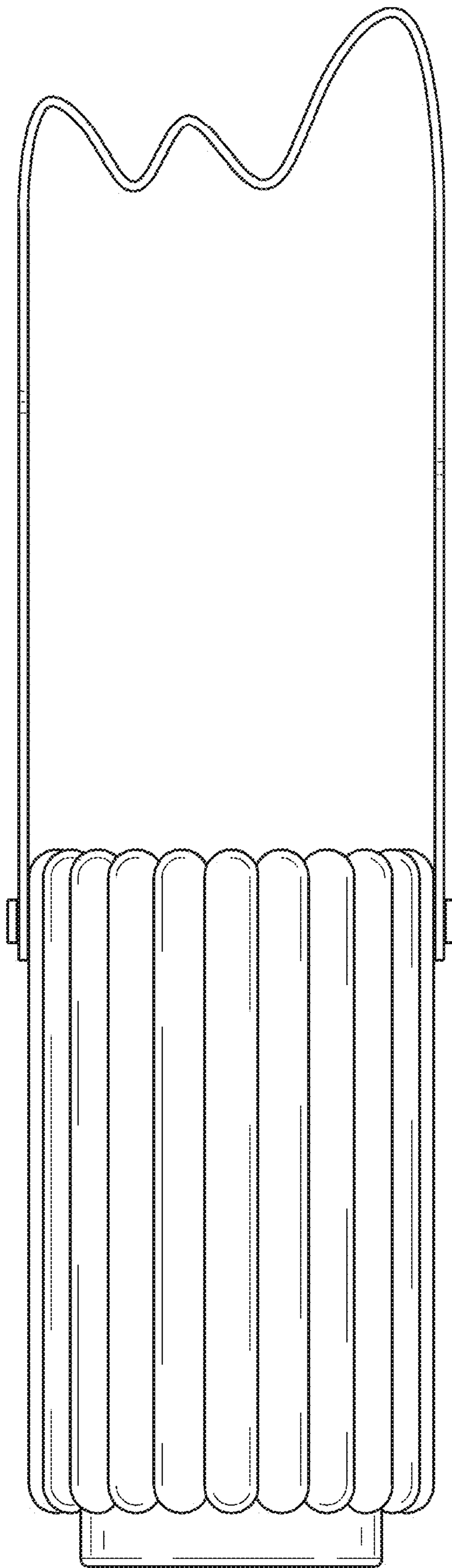

FIG. 123

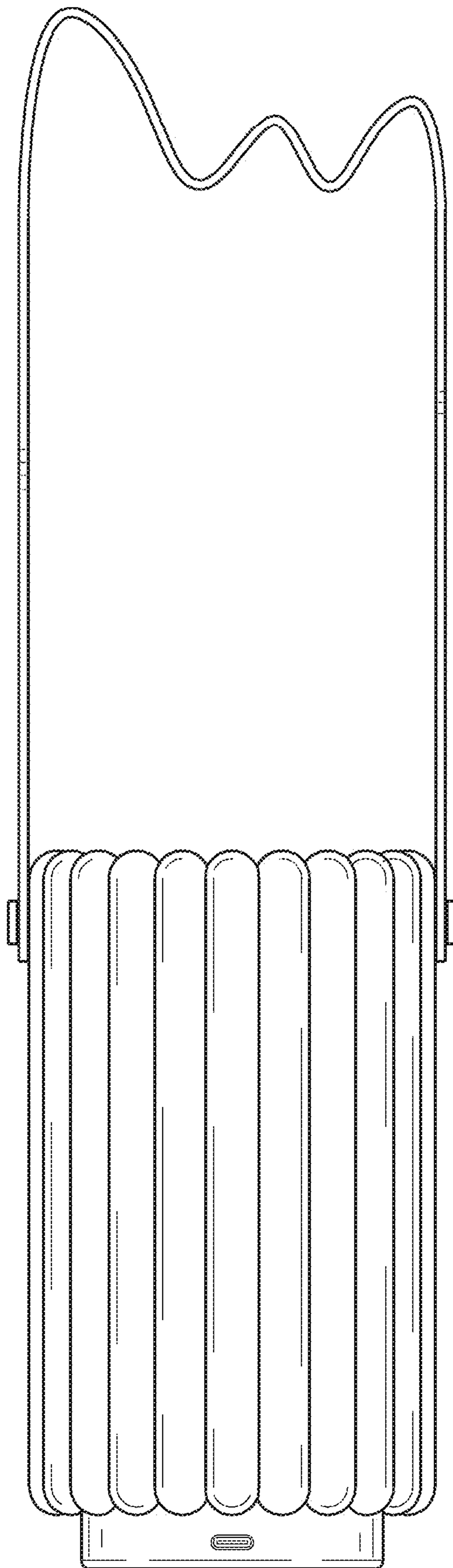

FIG. 124

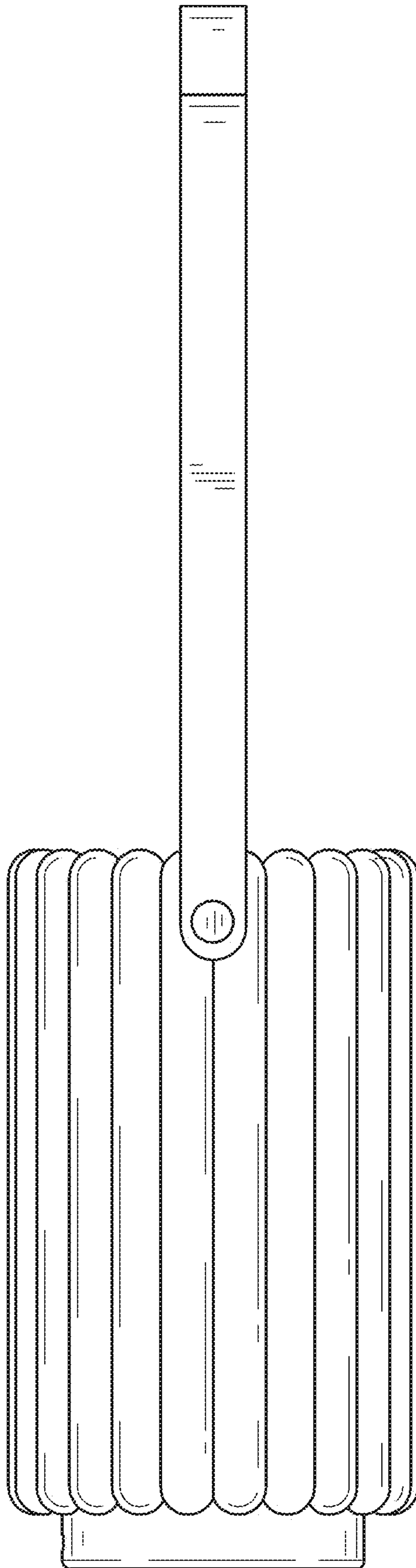

FIG. 125

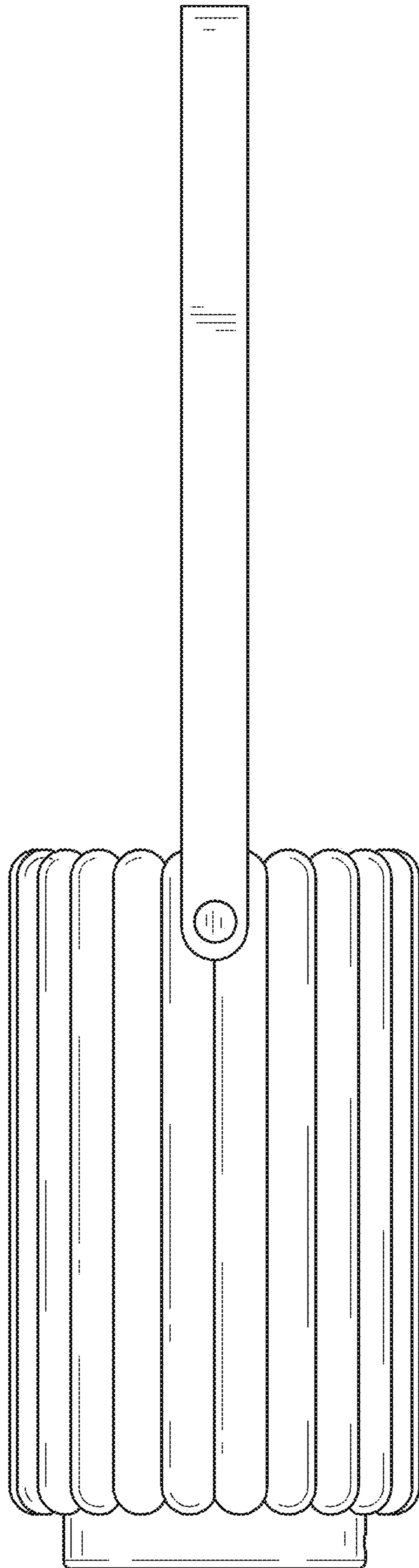

FIG. 126

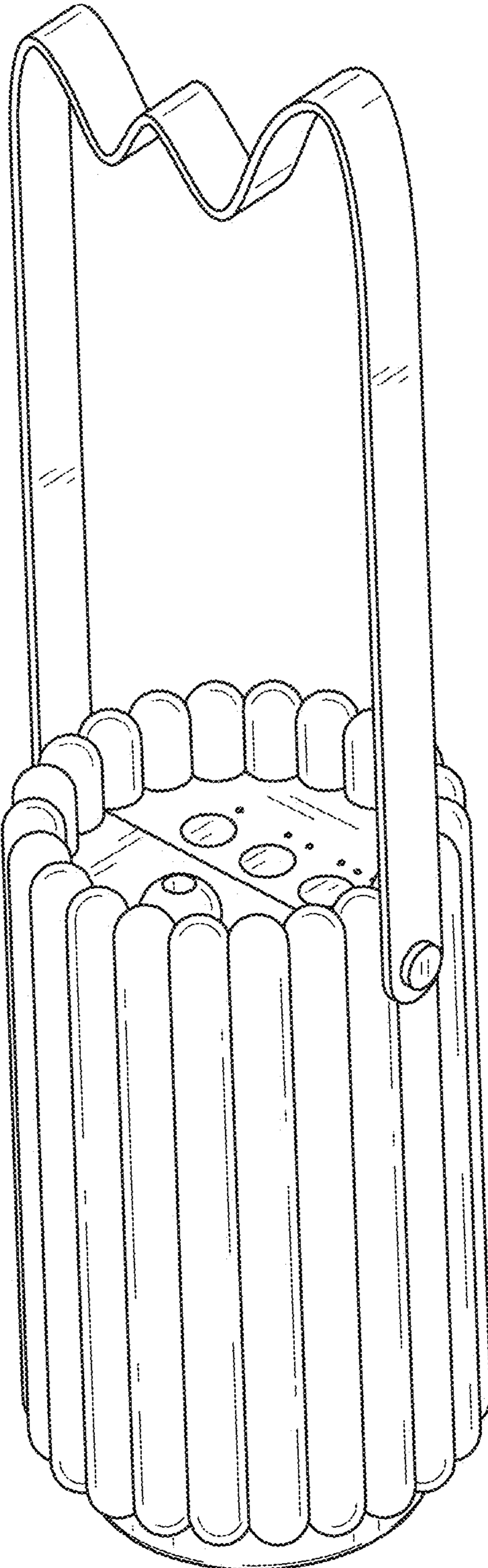

FIG. 127

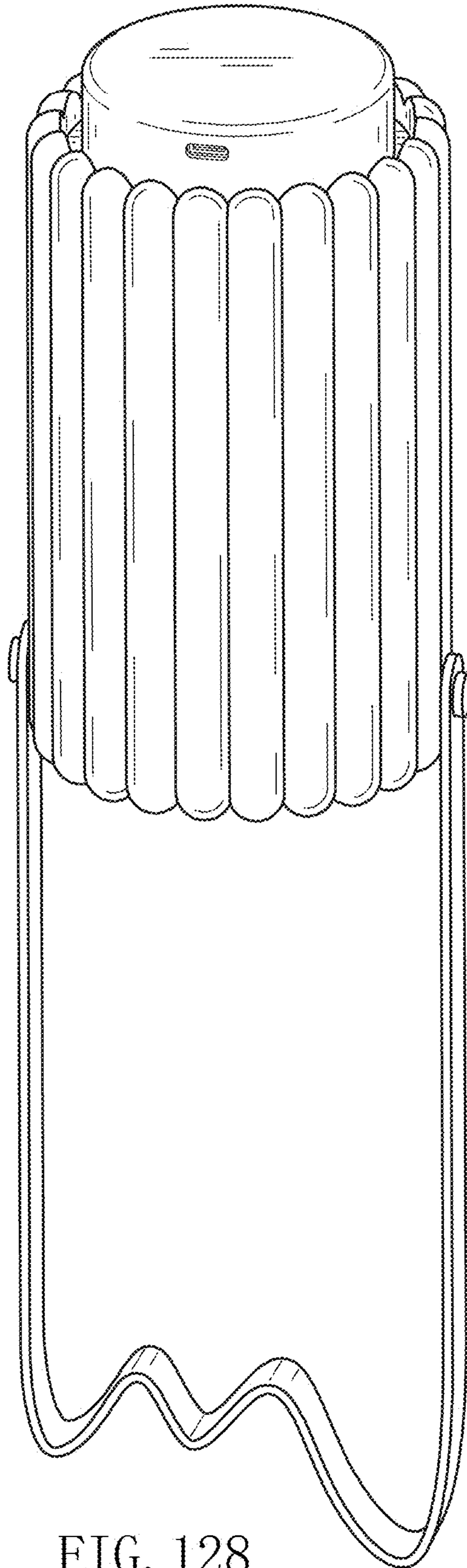

FIG. 128

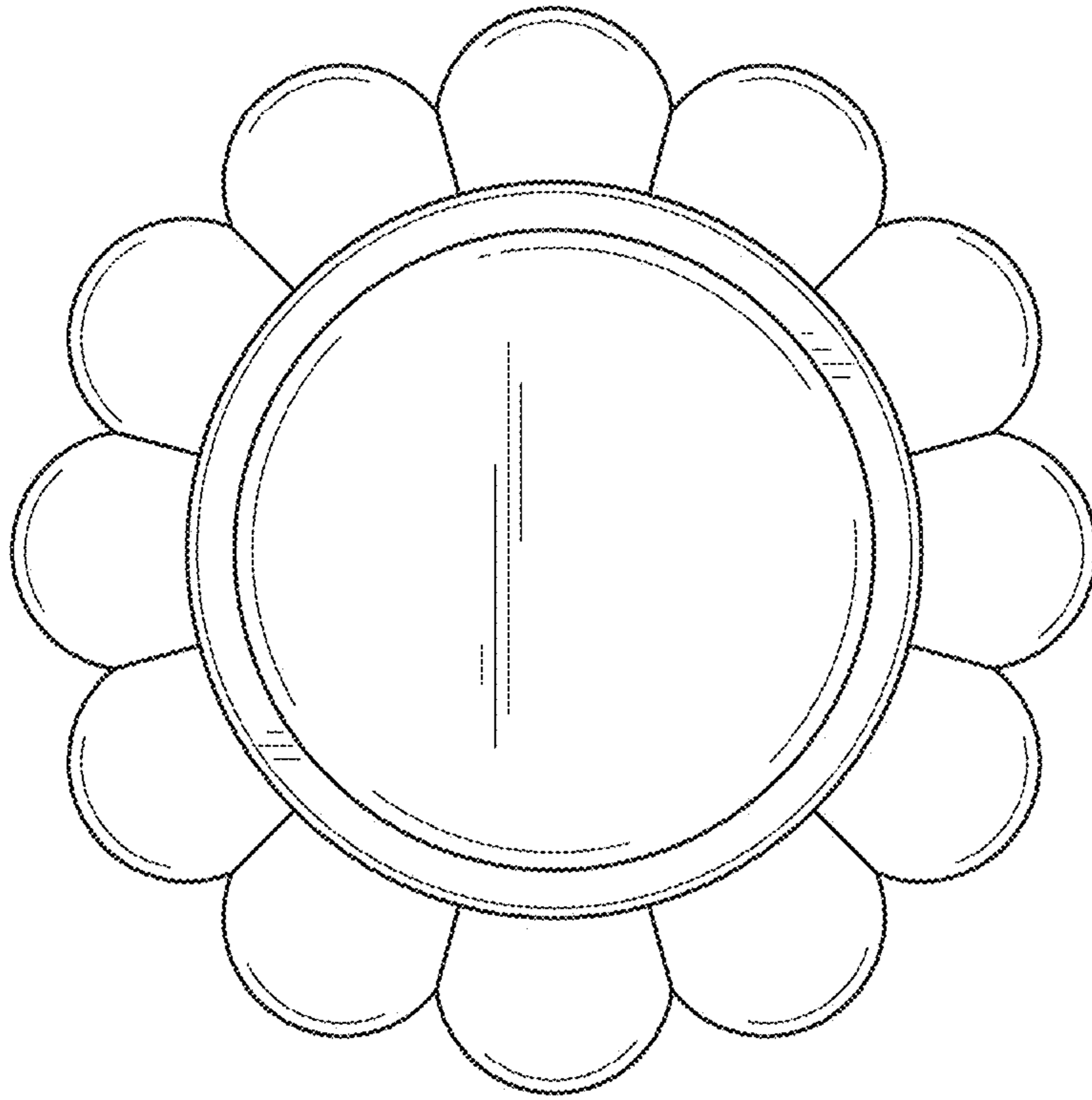

FIG. 130

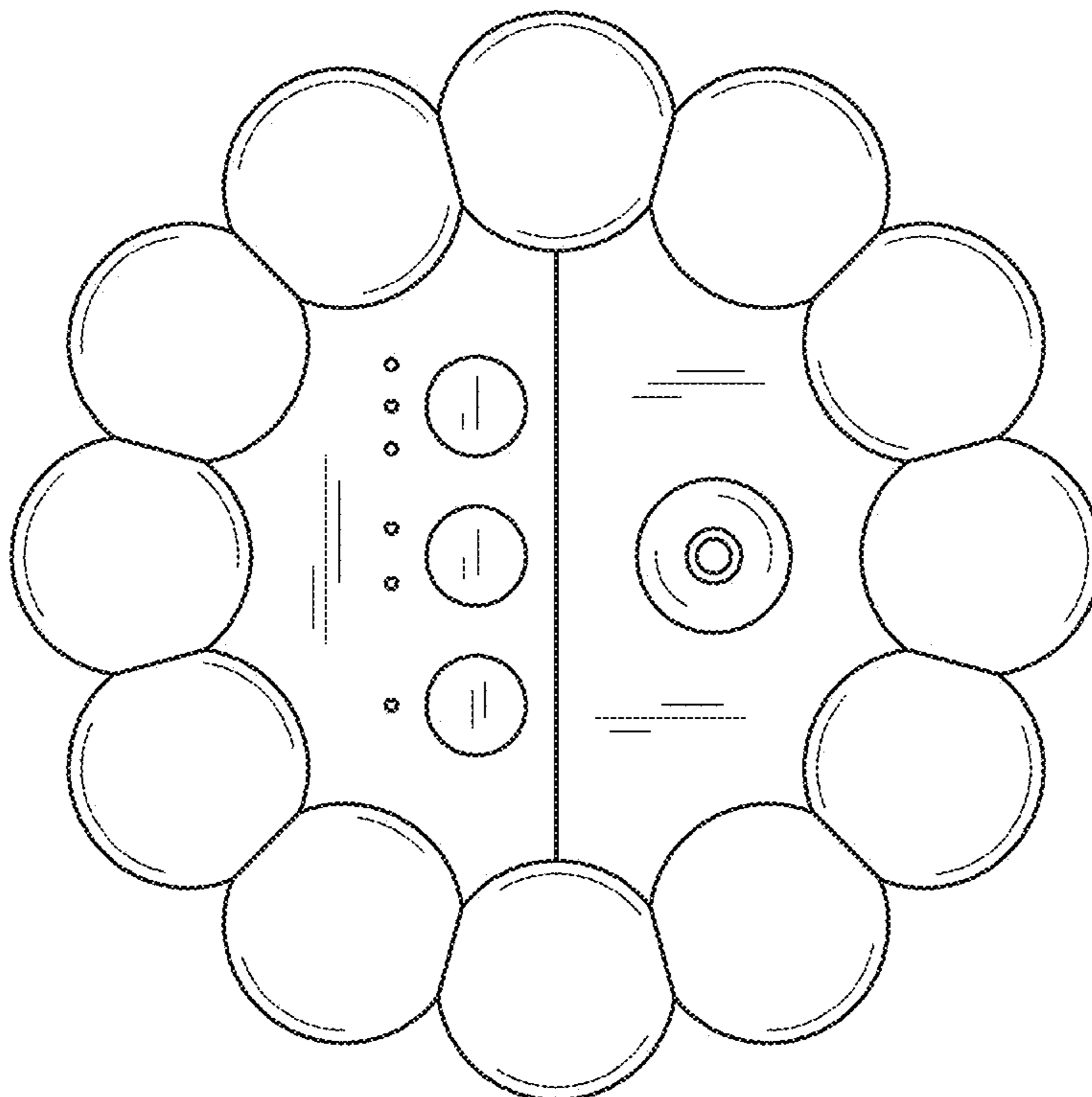

FIG. 129



FIG. 132



FIG. 131



FIG. 134



FIG. 133

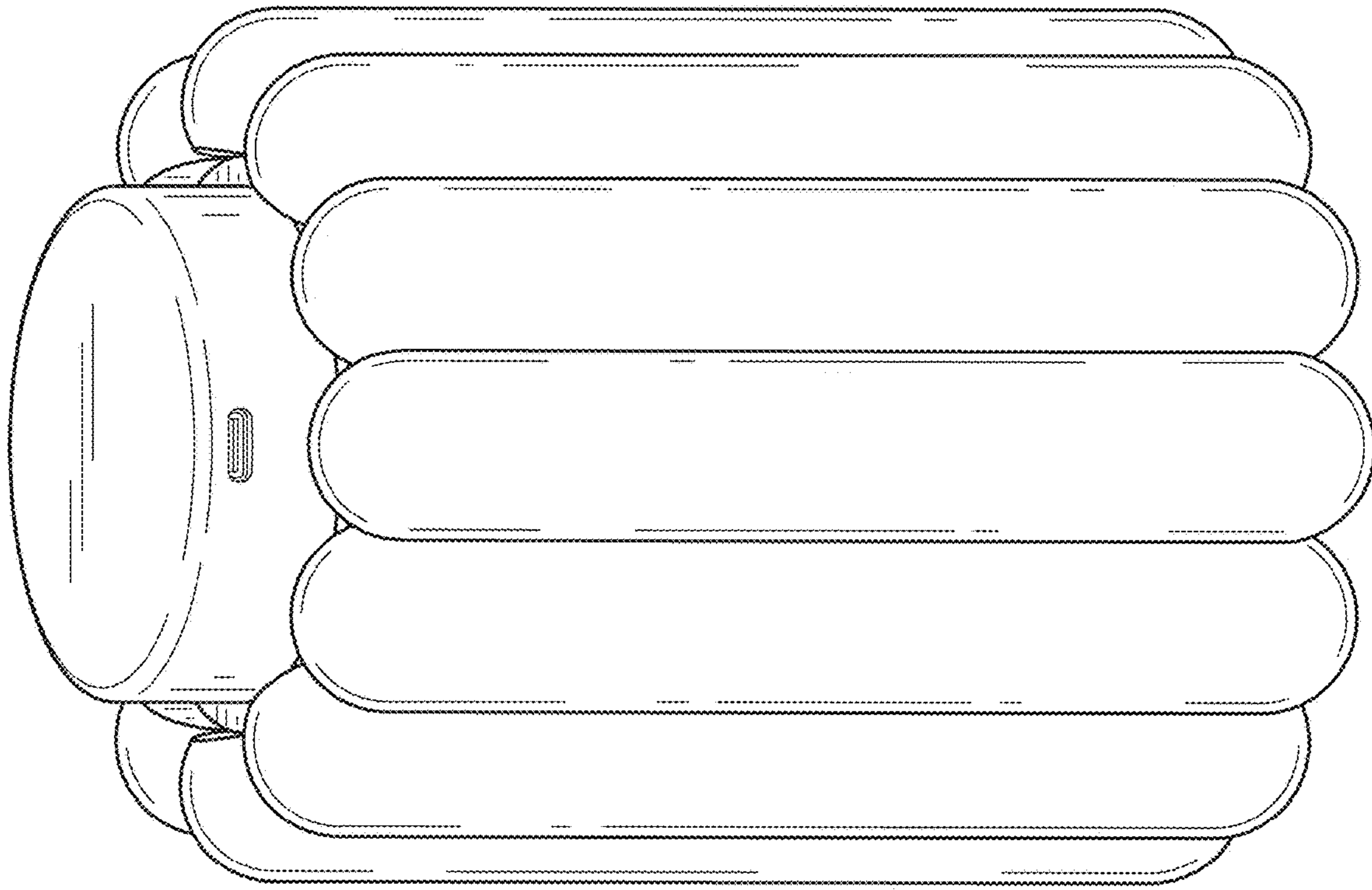

FIG. 135

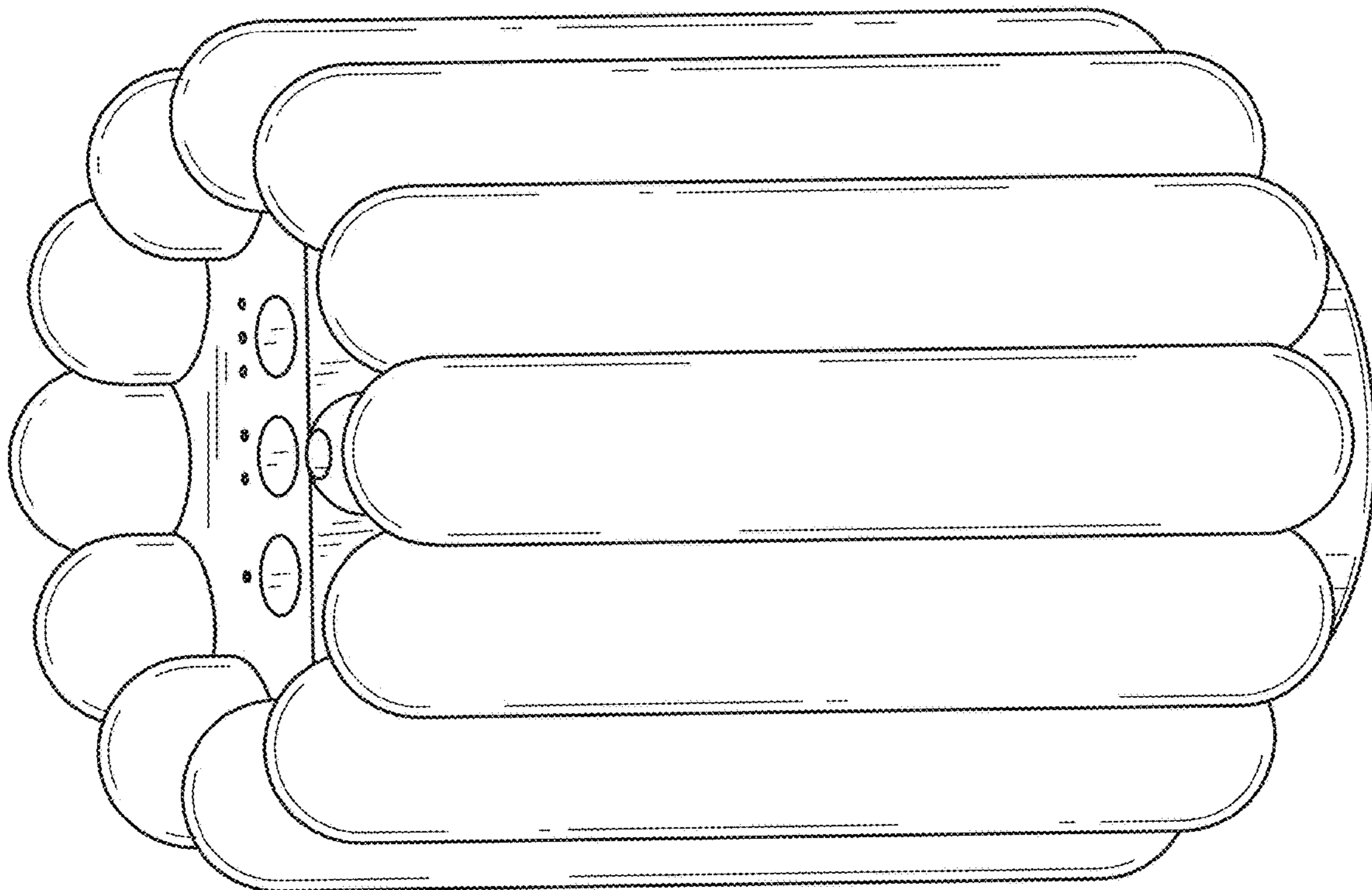

FIG. 136

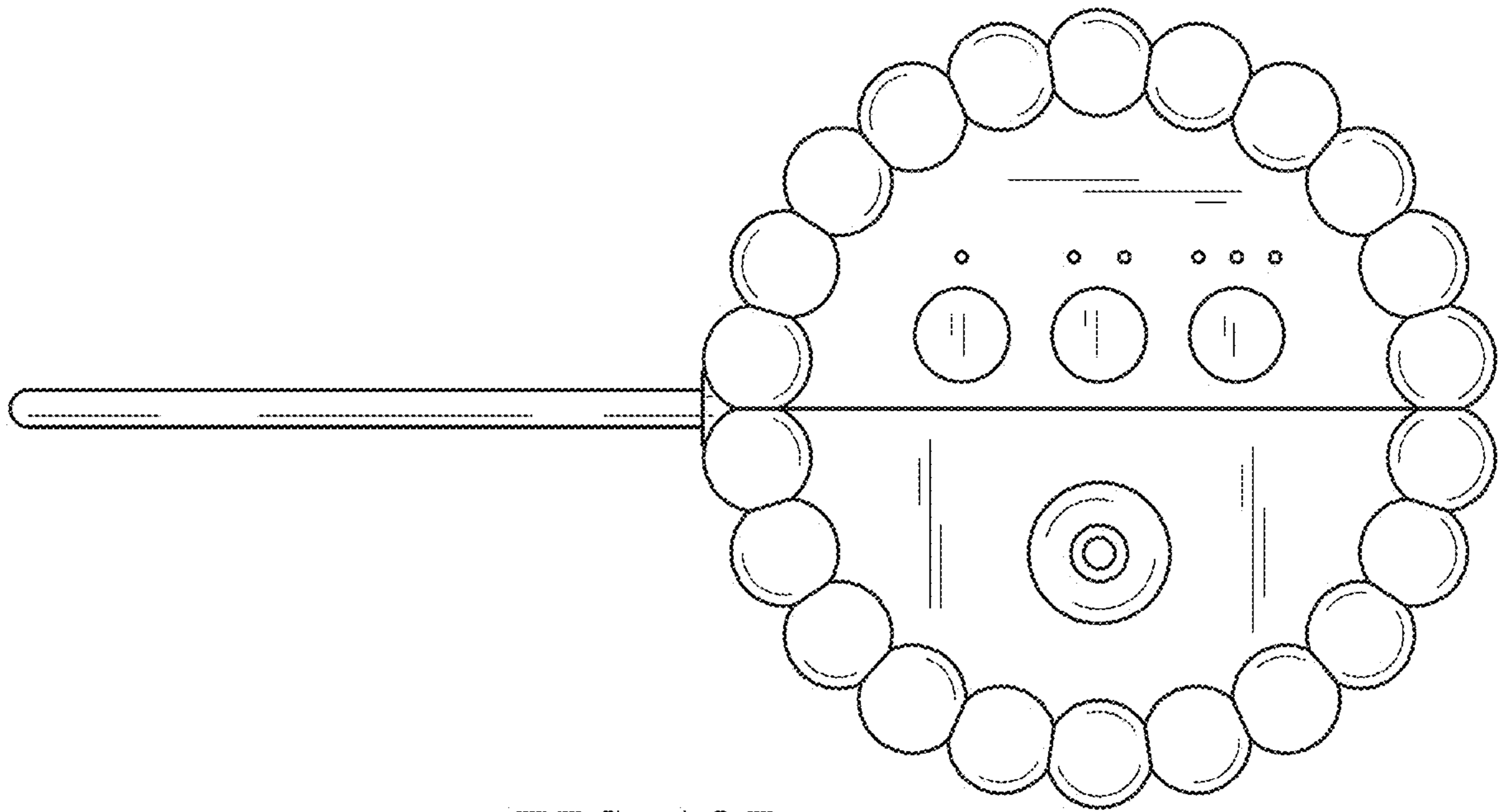

FIG. 137

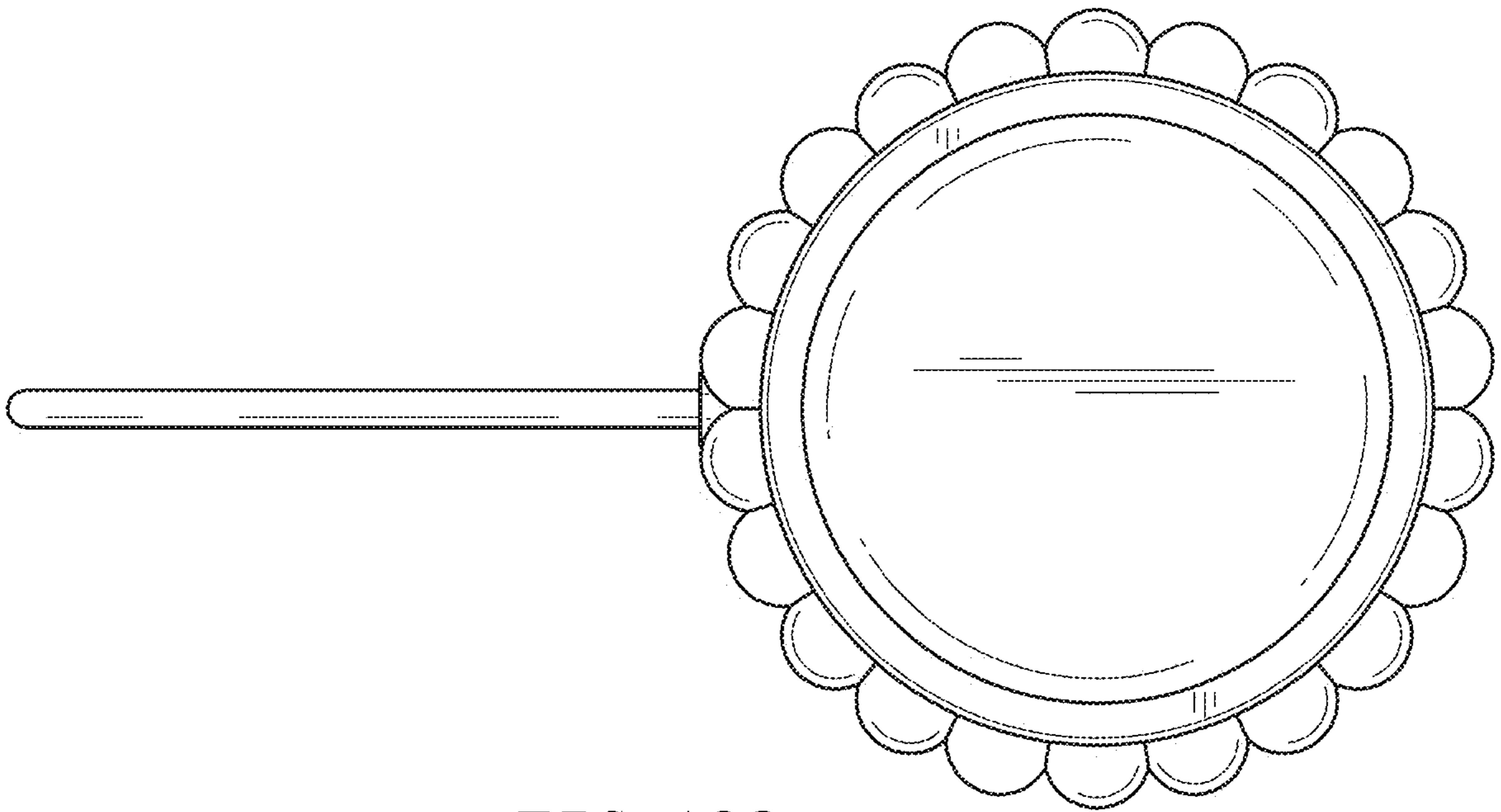

FIG. 138

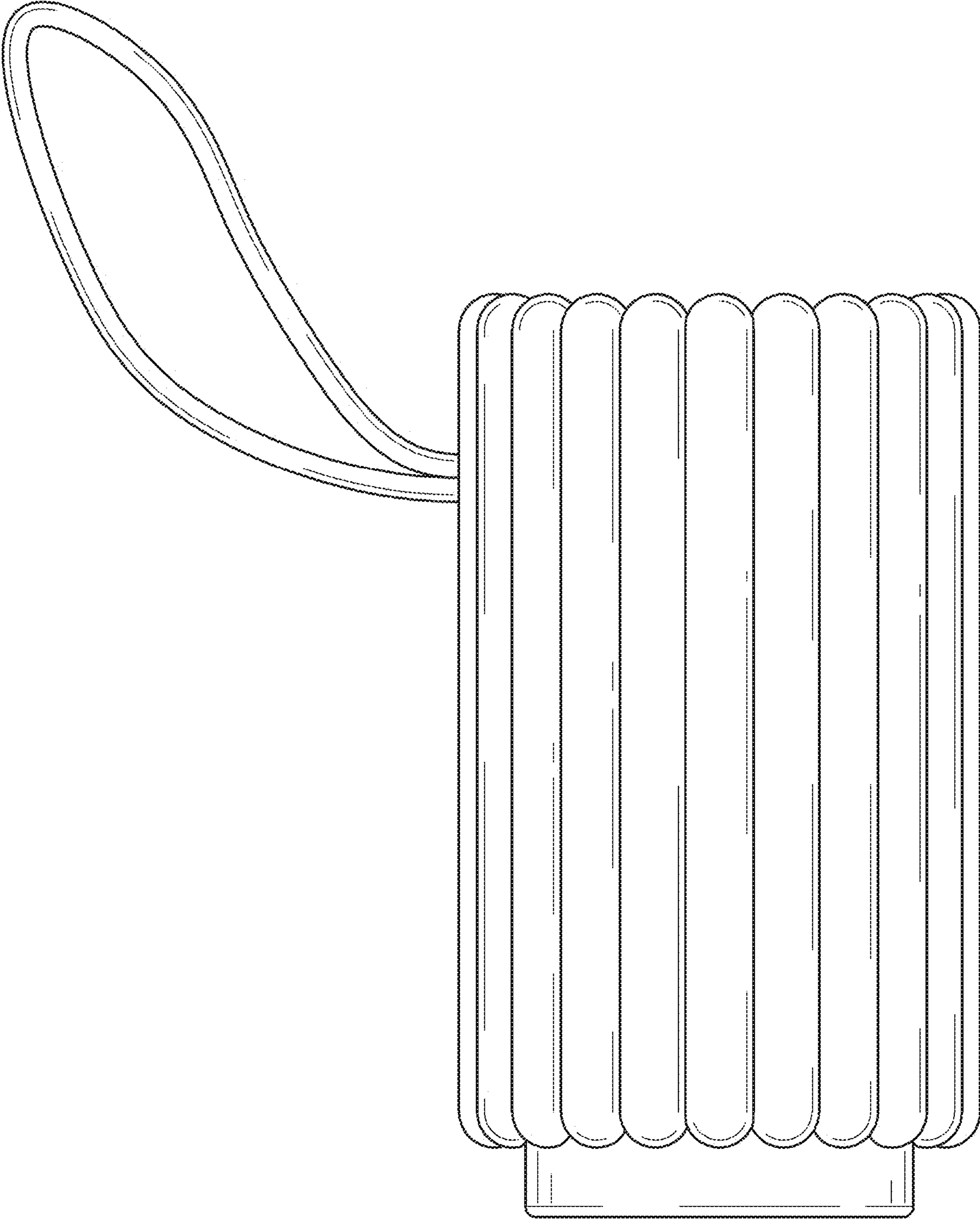

FIG. 139

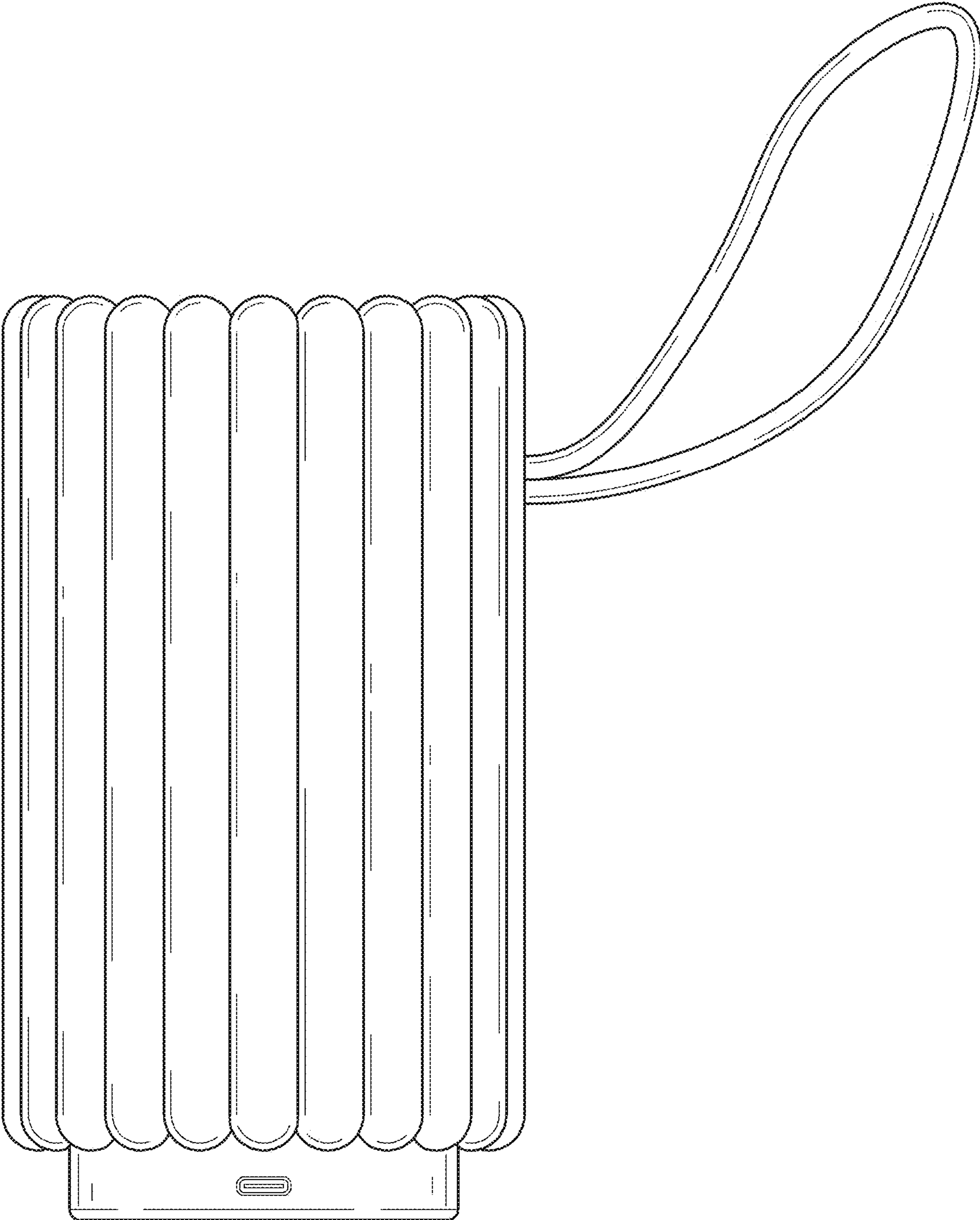

FIG. 140

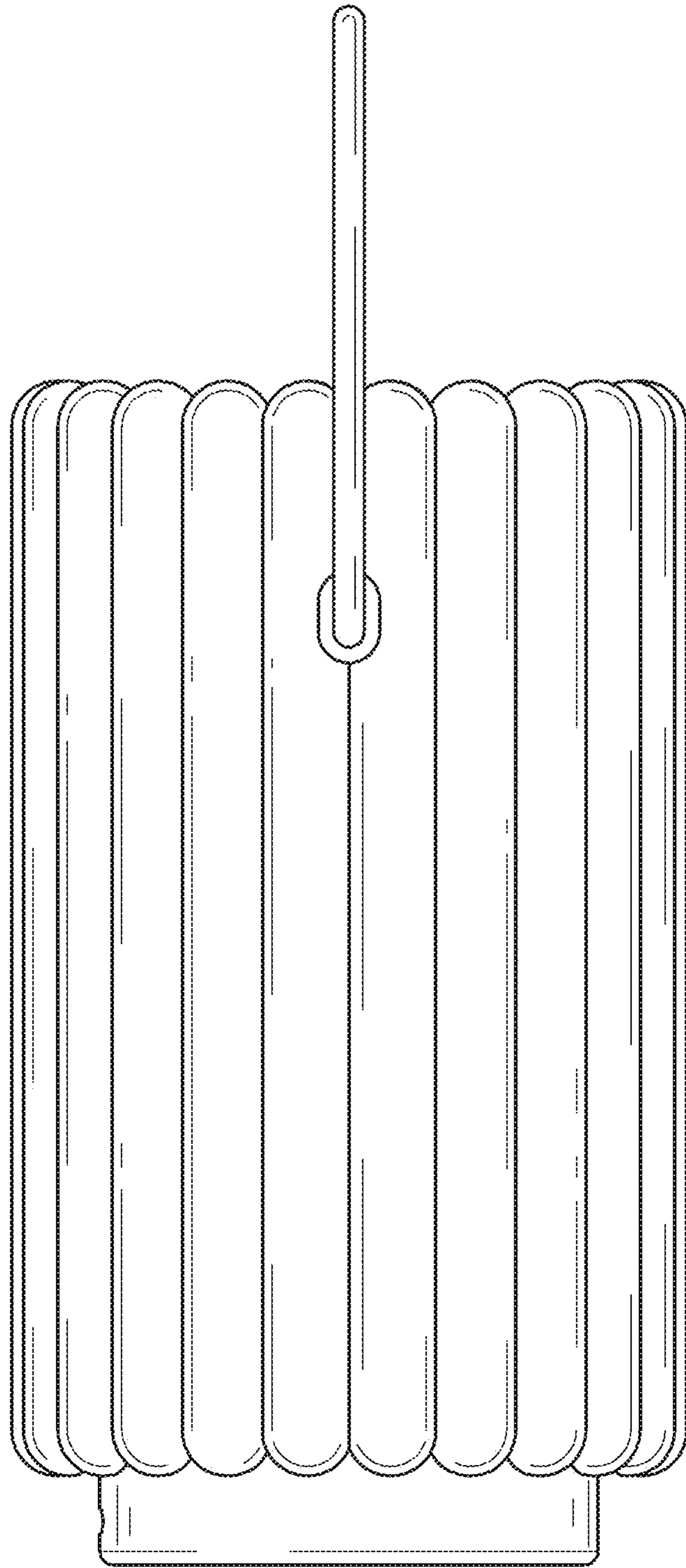

FIG. 141

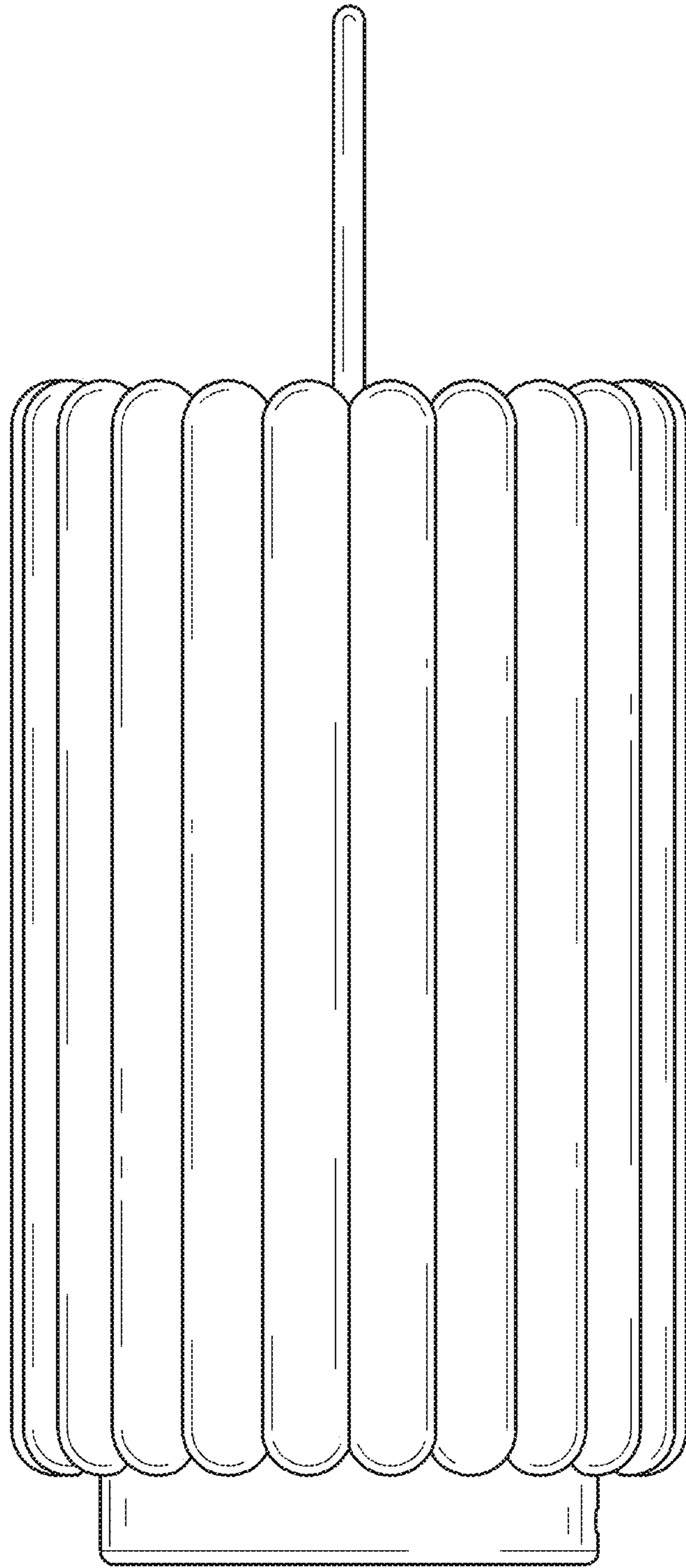

FIG. 142

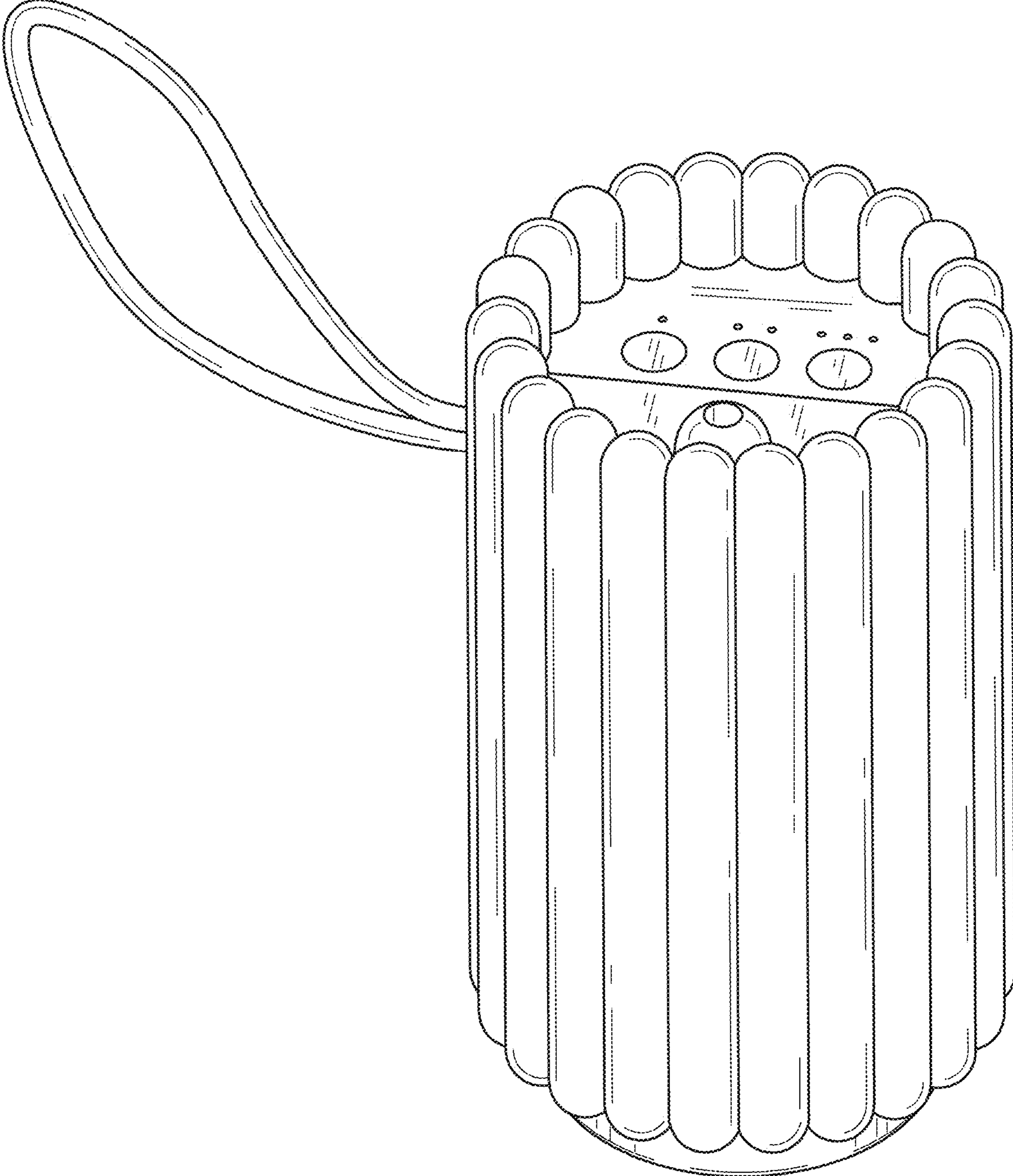

FIG. 143

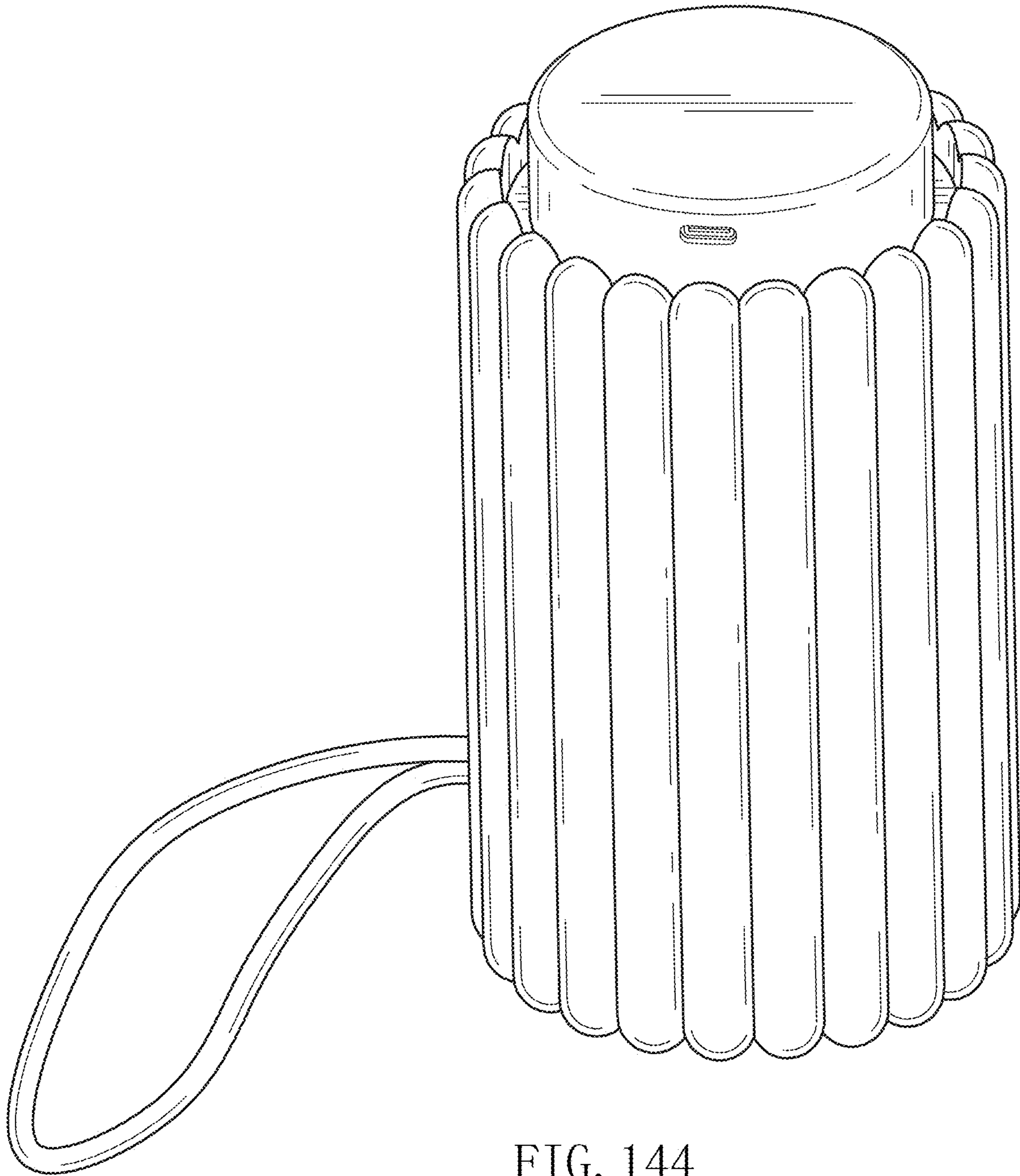

FIG. 144

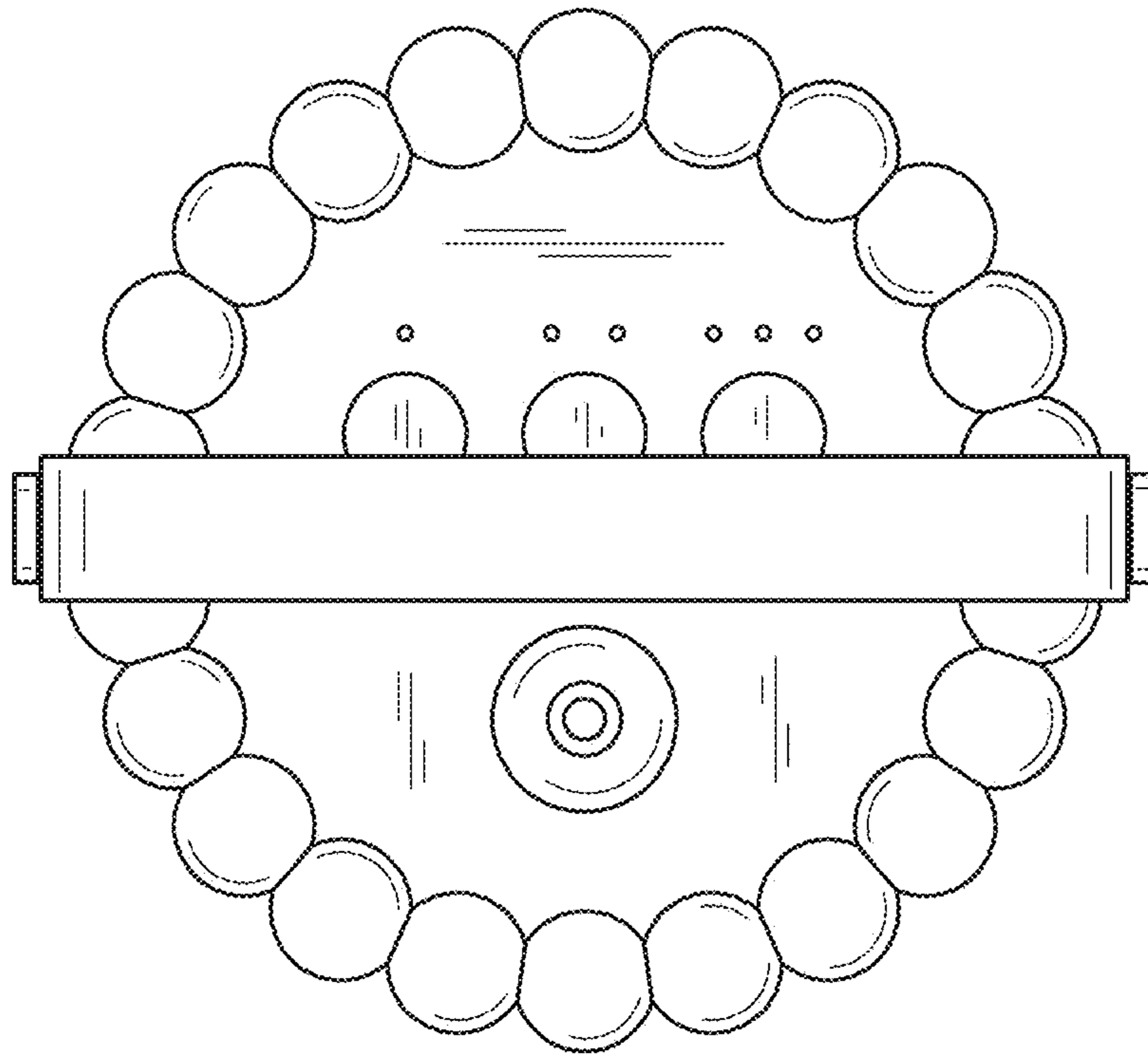

FIG. 145

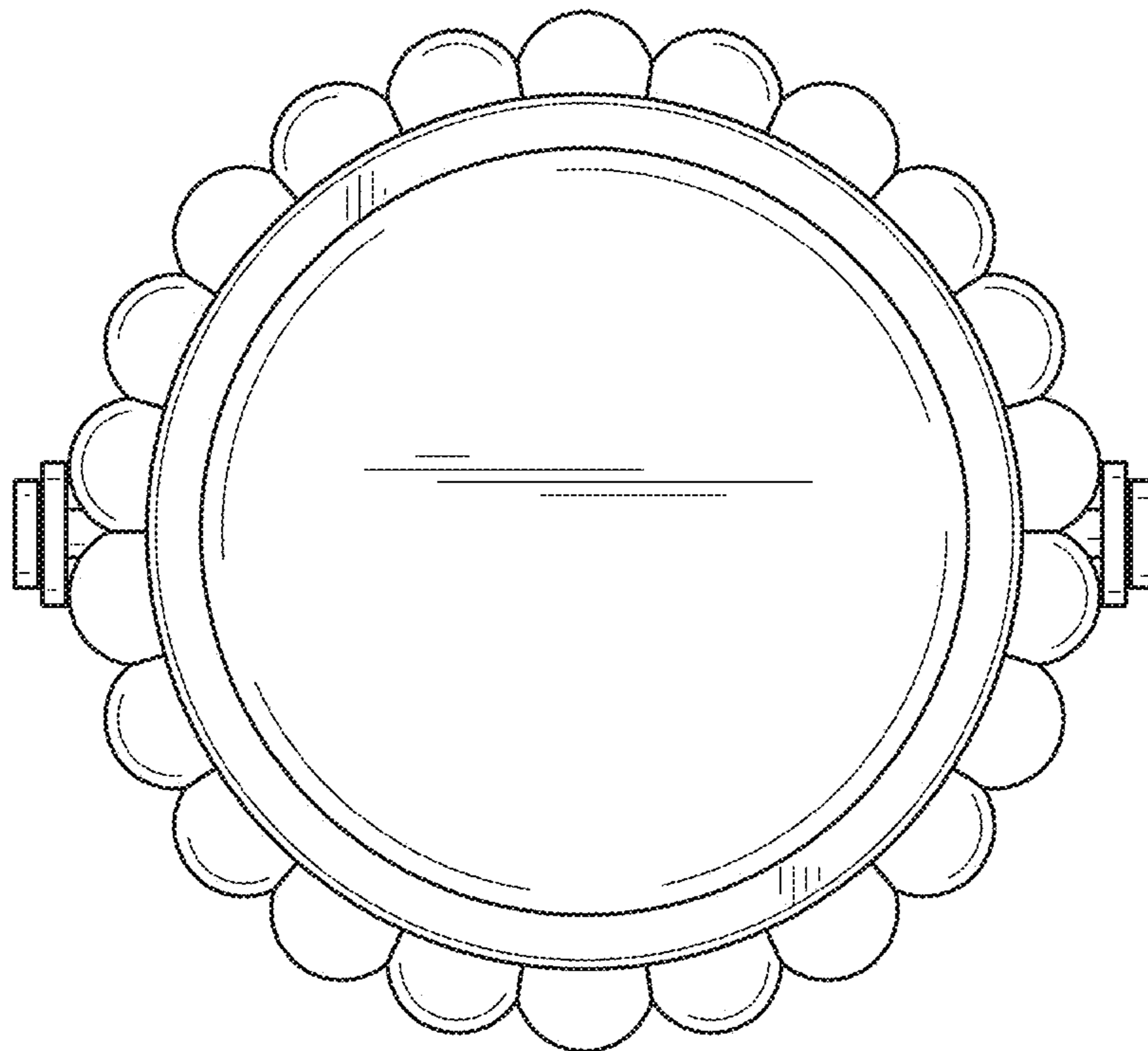

FIG. 146

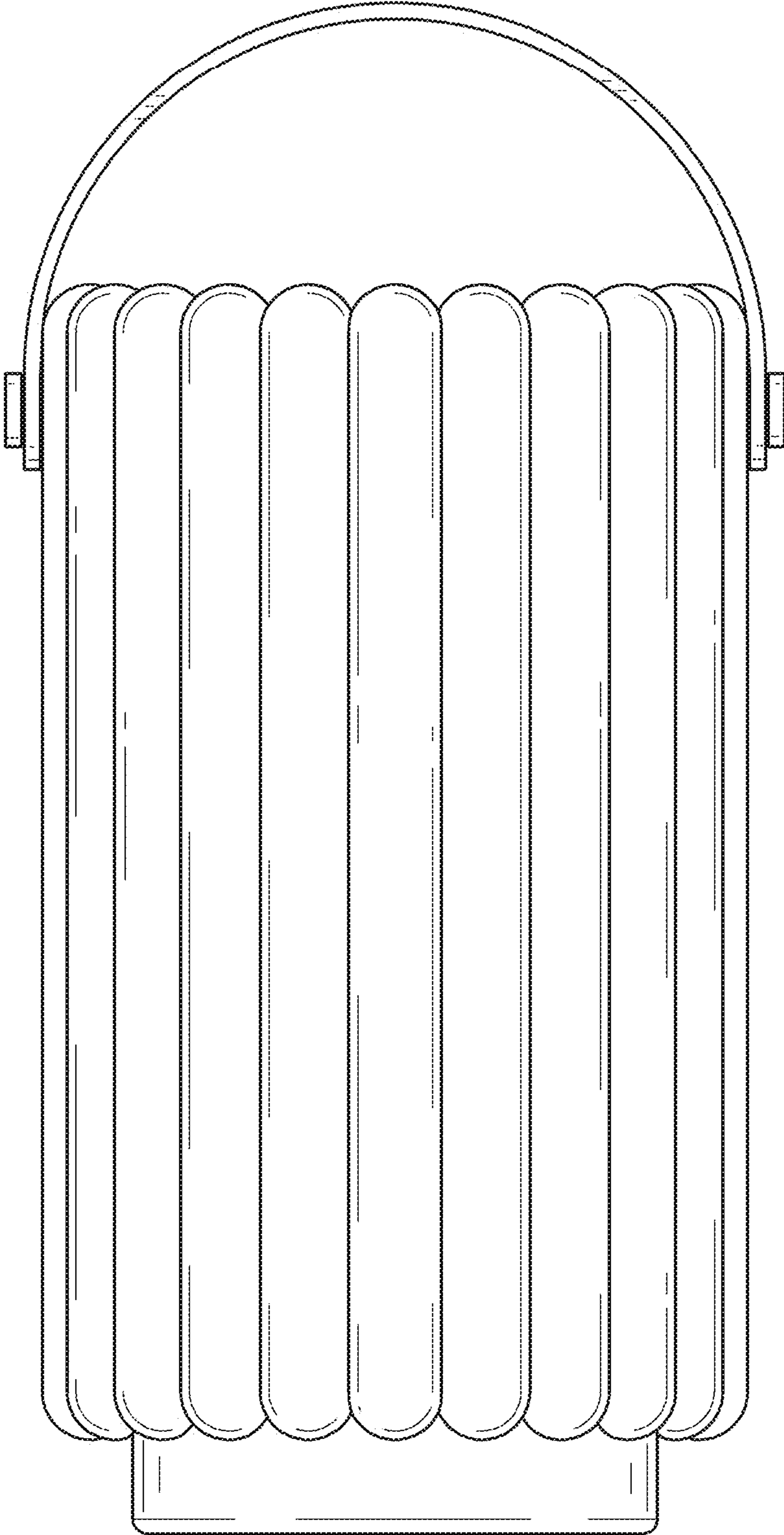

FIG. 147

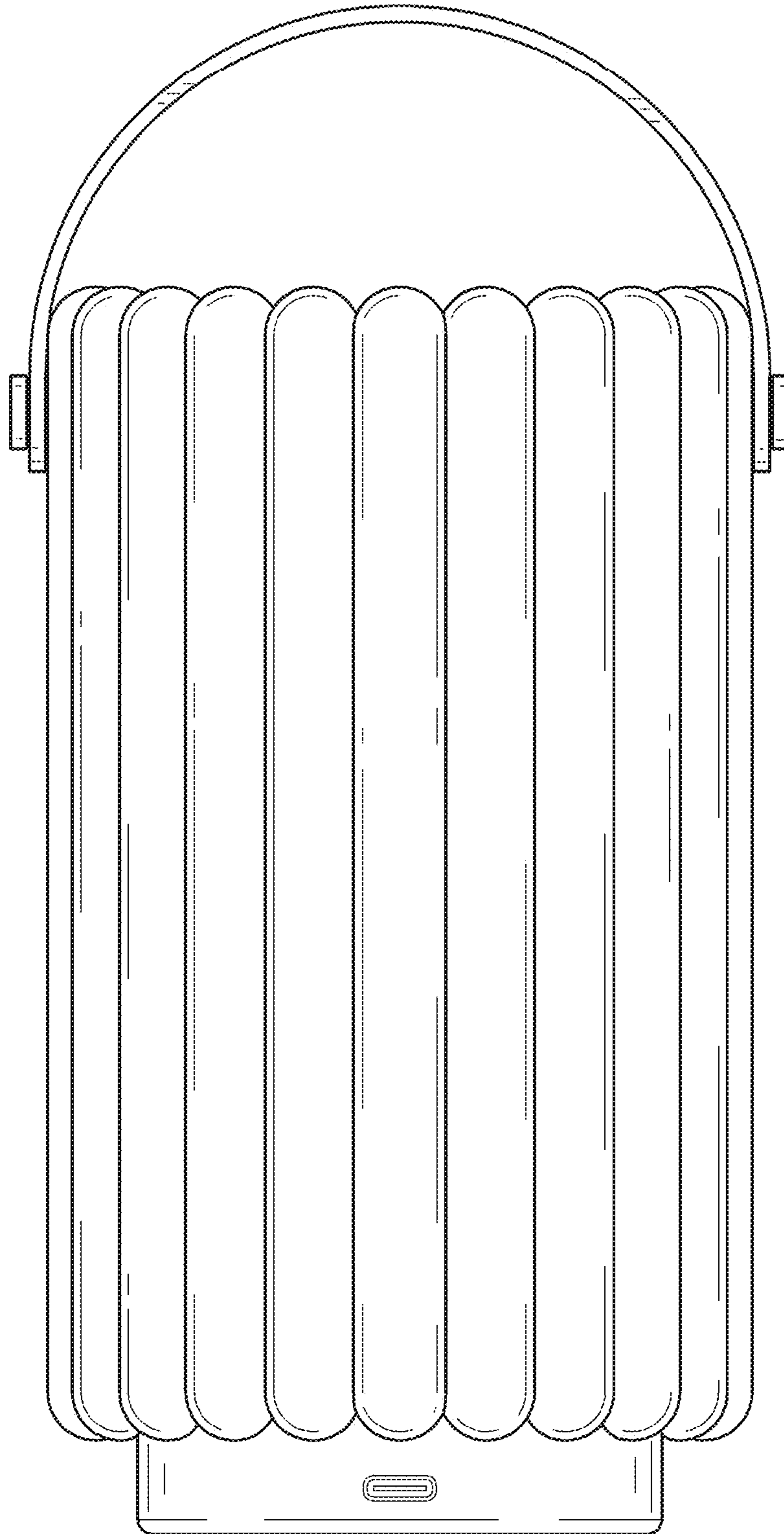

FIG. 148

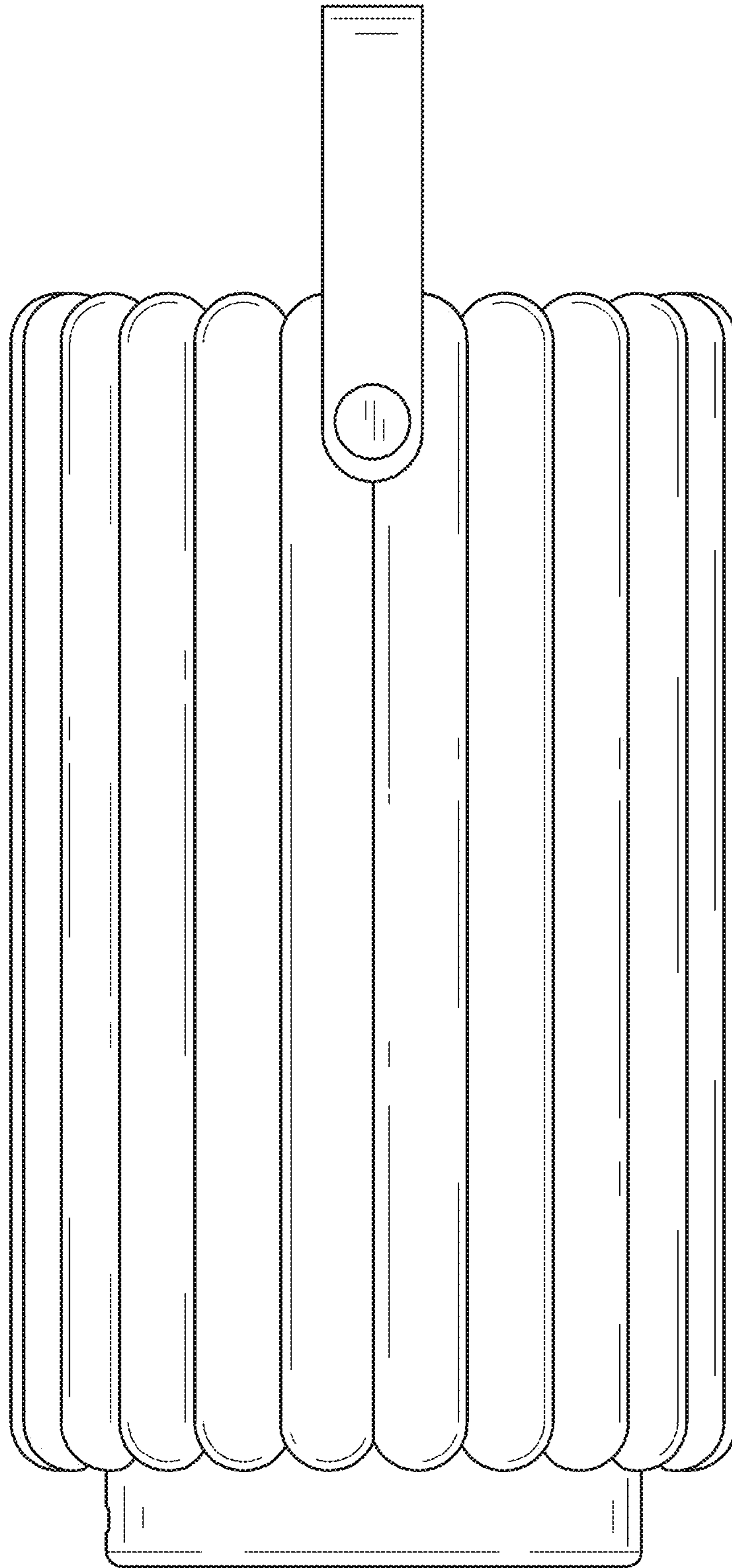

FIG. 149

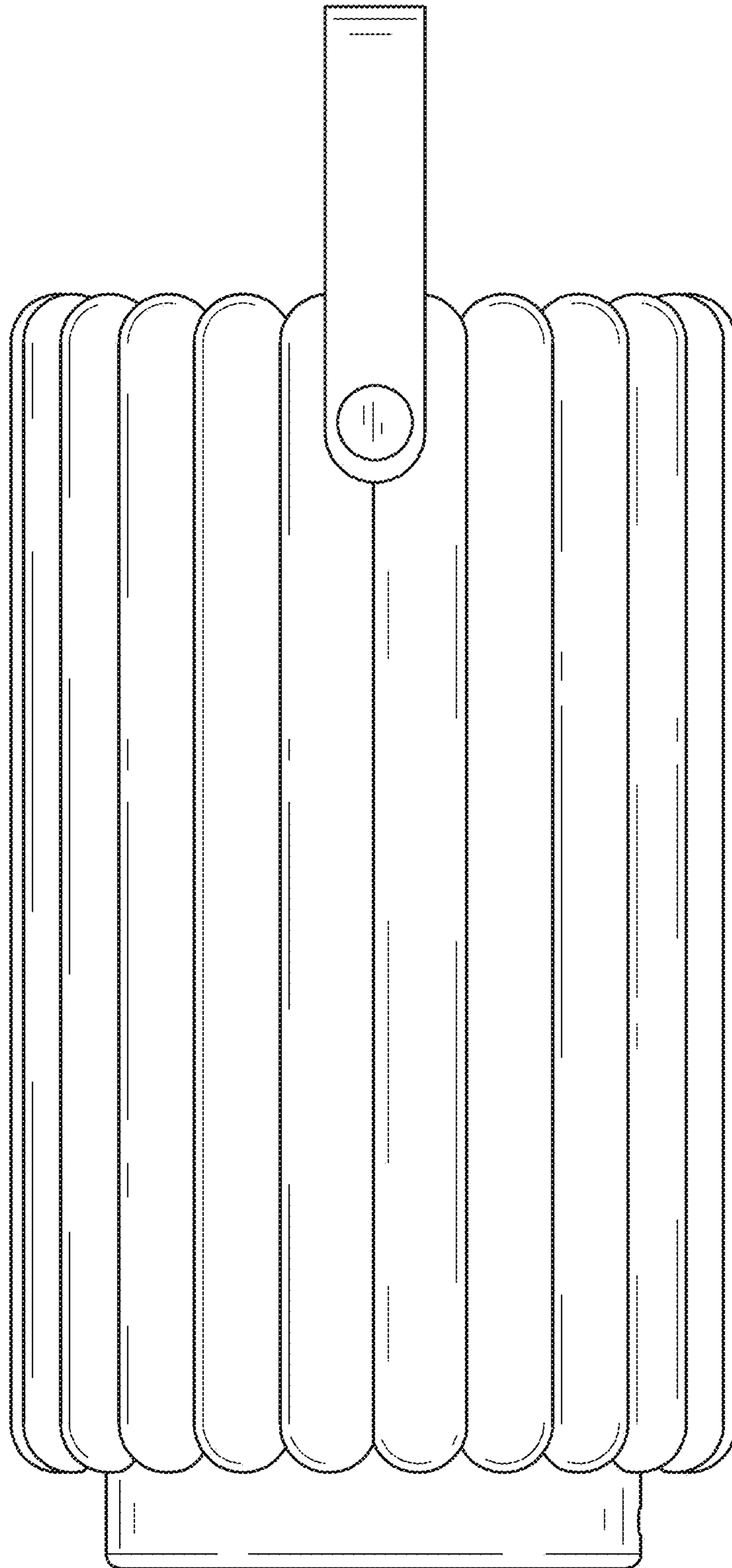

FIG. 150

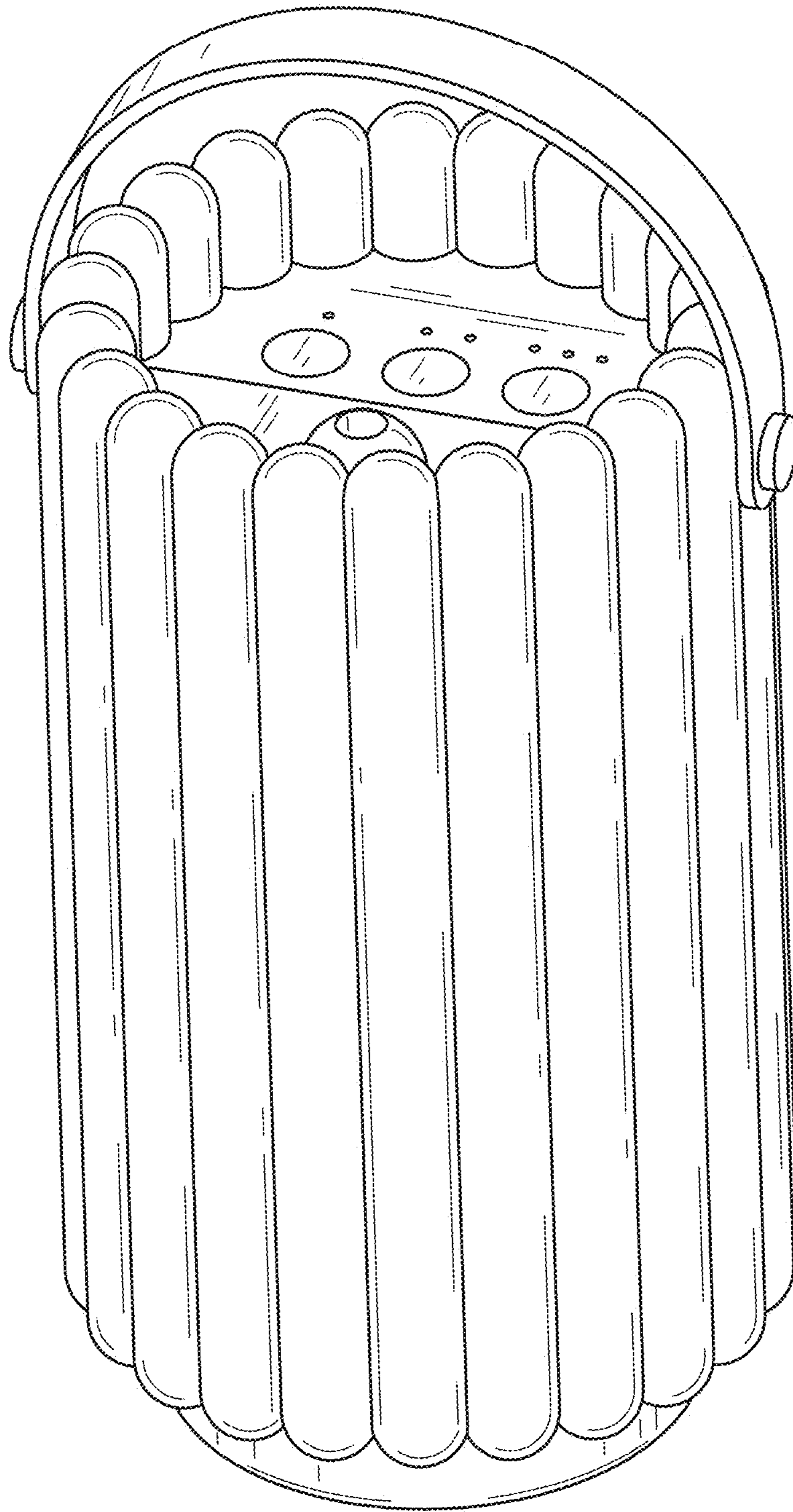

FIG. 151

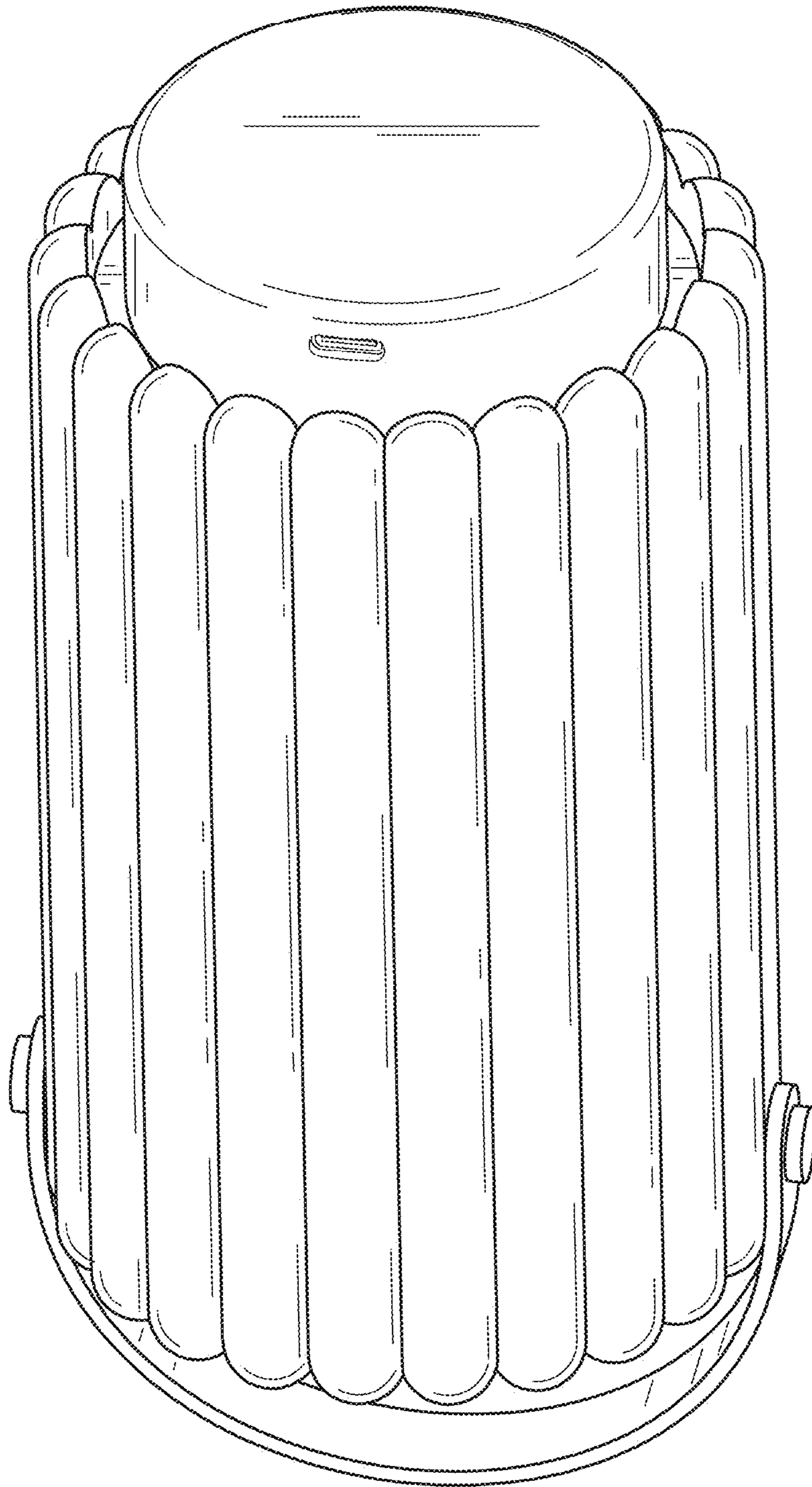

FIG. 152

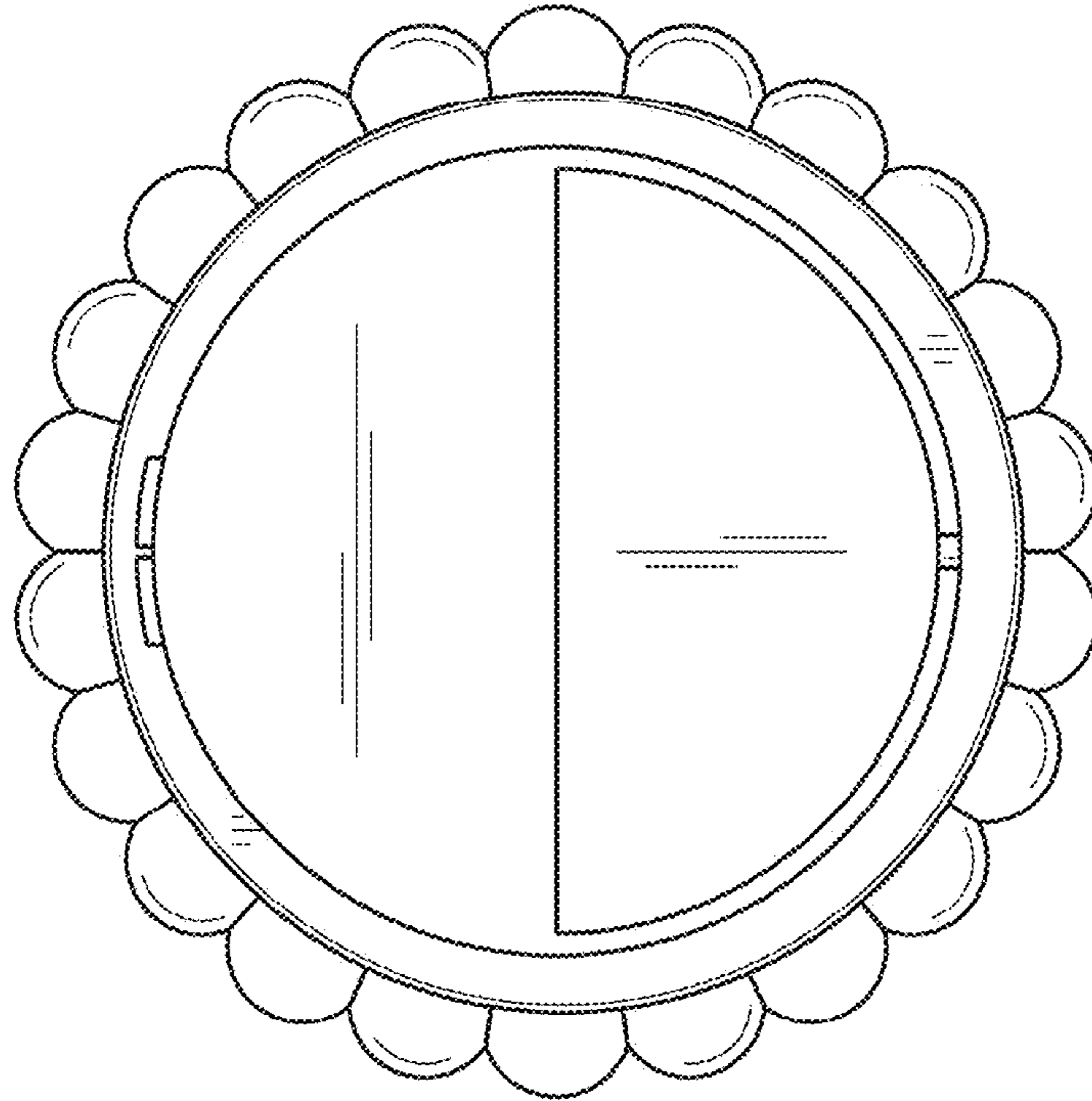

FIG. 154

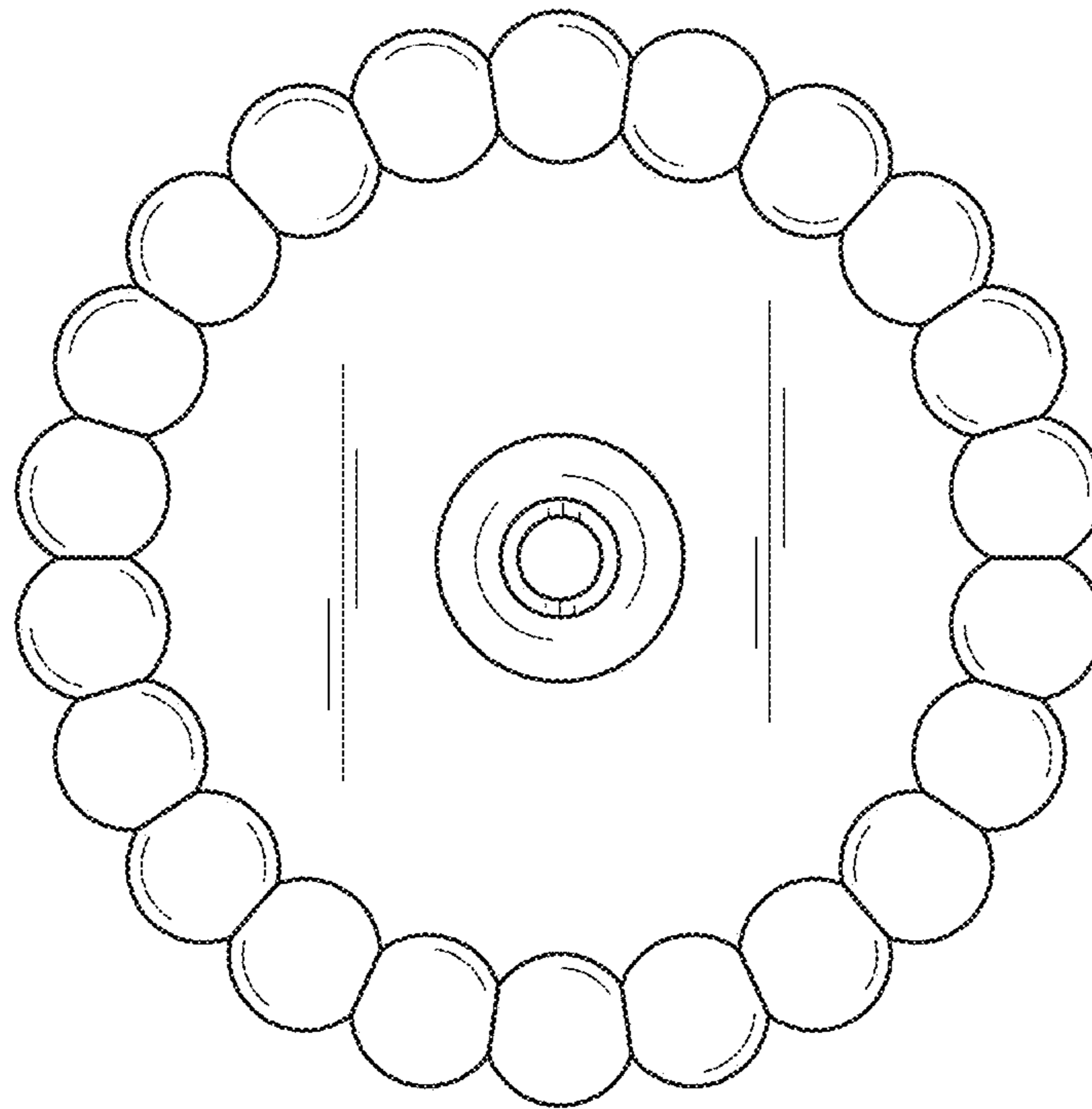

FIG. 153



FIG. 155



FIG. 156



FIG. 158



FIG. 157

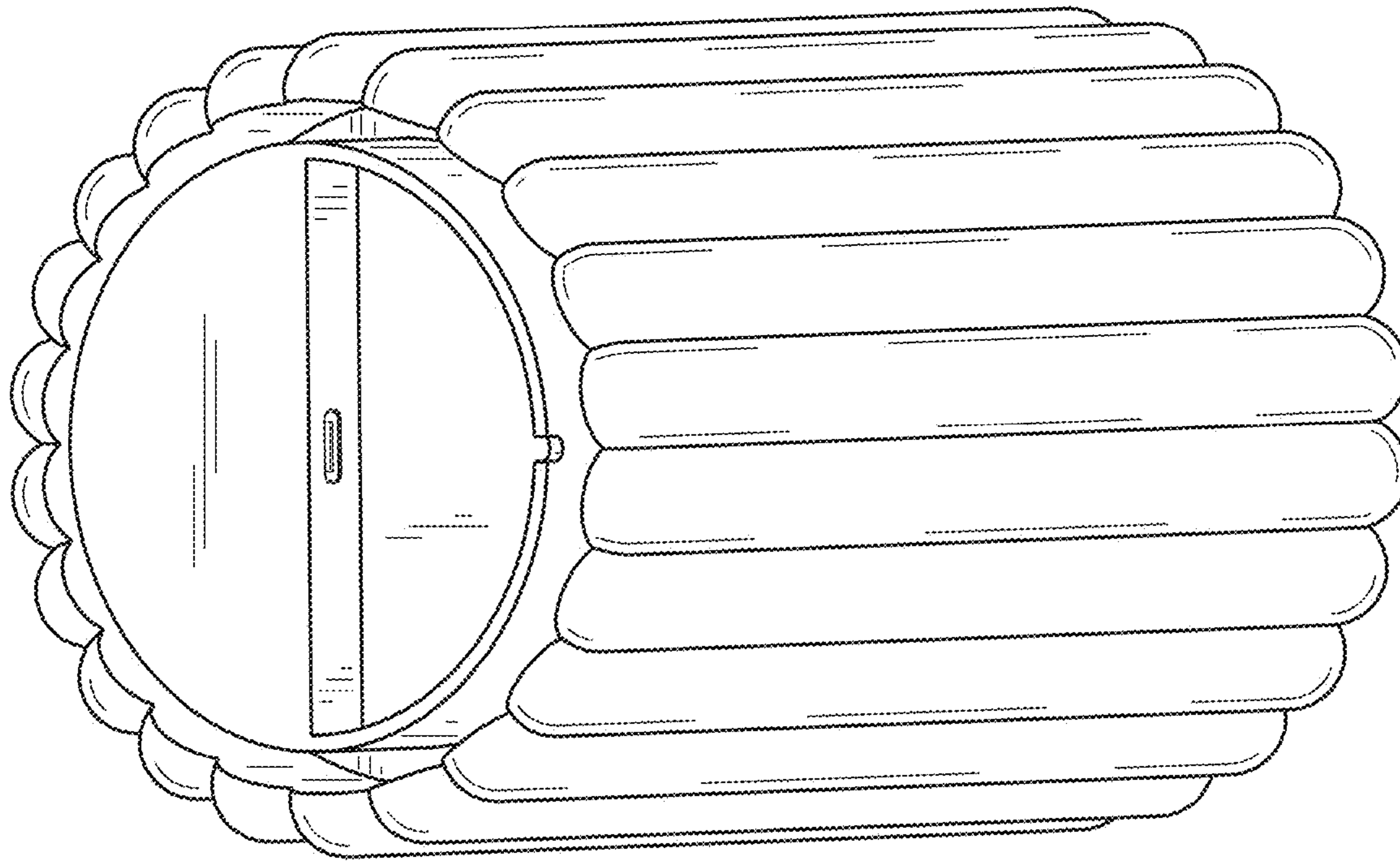

FIG. 160

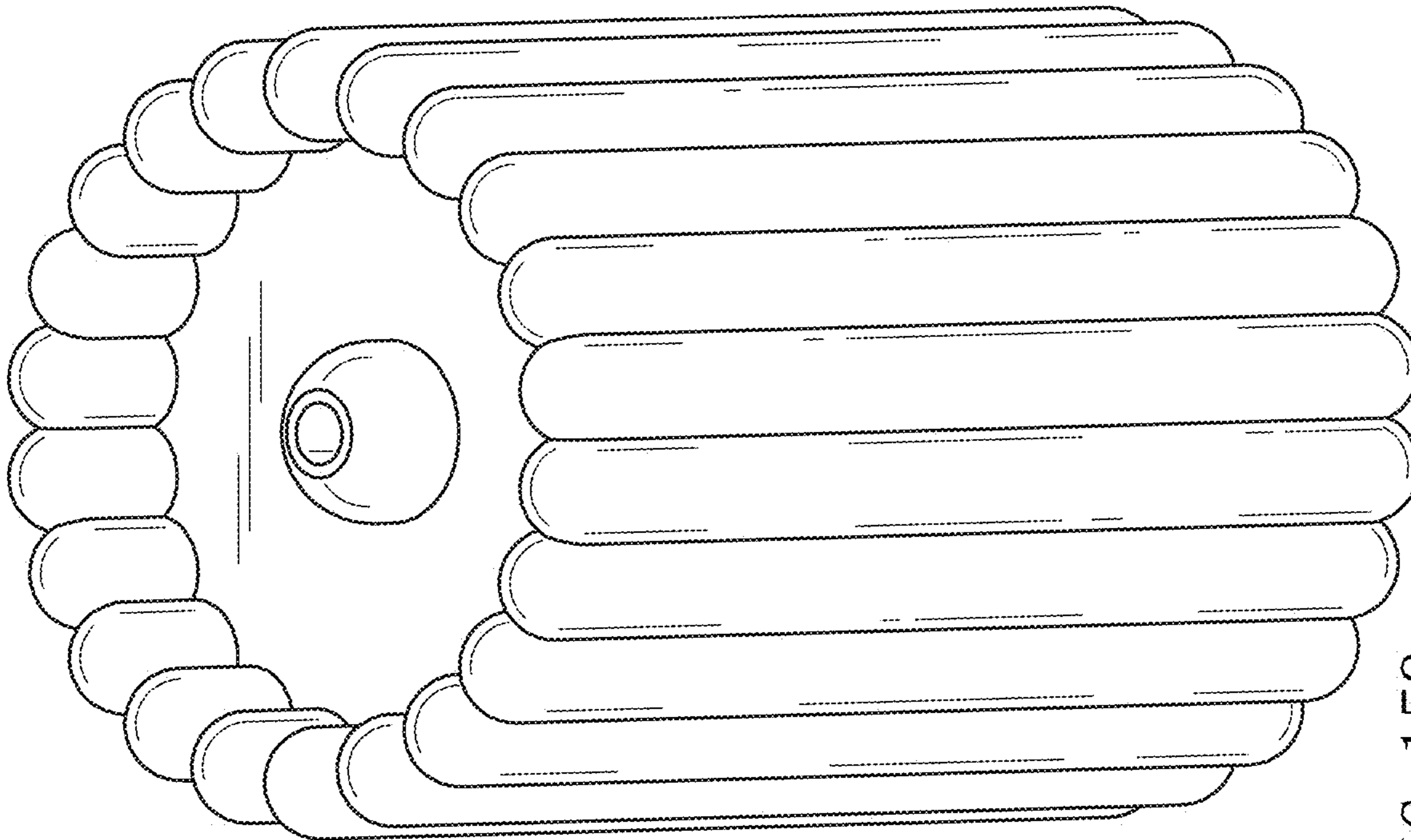

FIG. 159

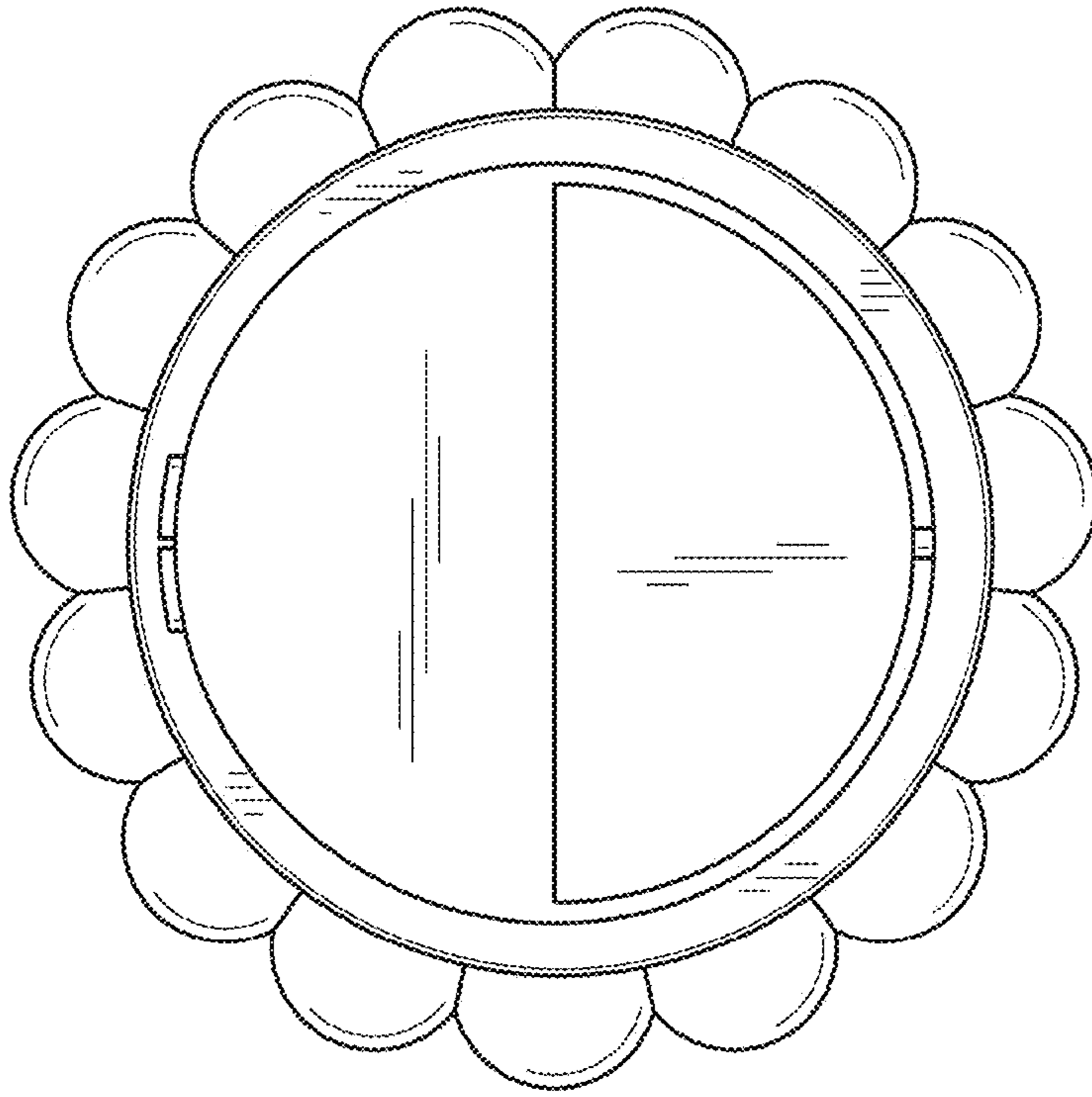

FIG. 162

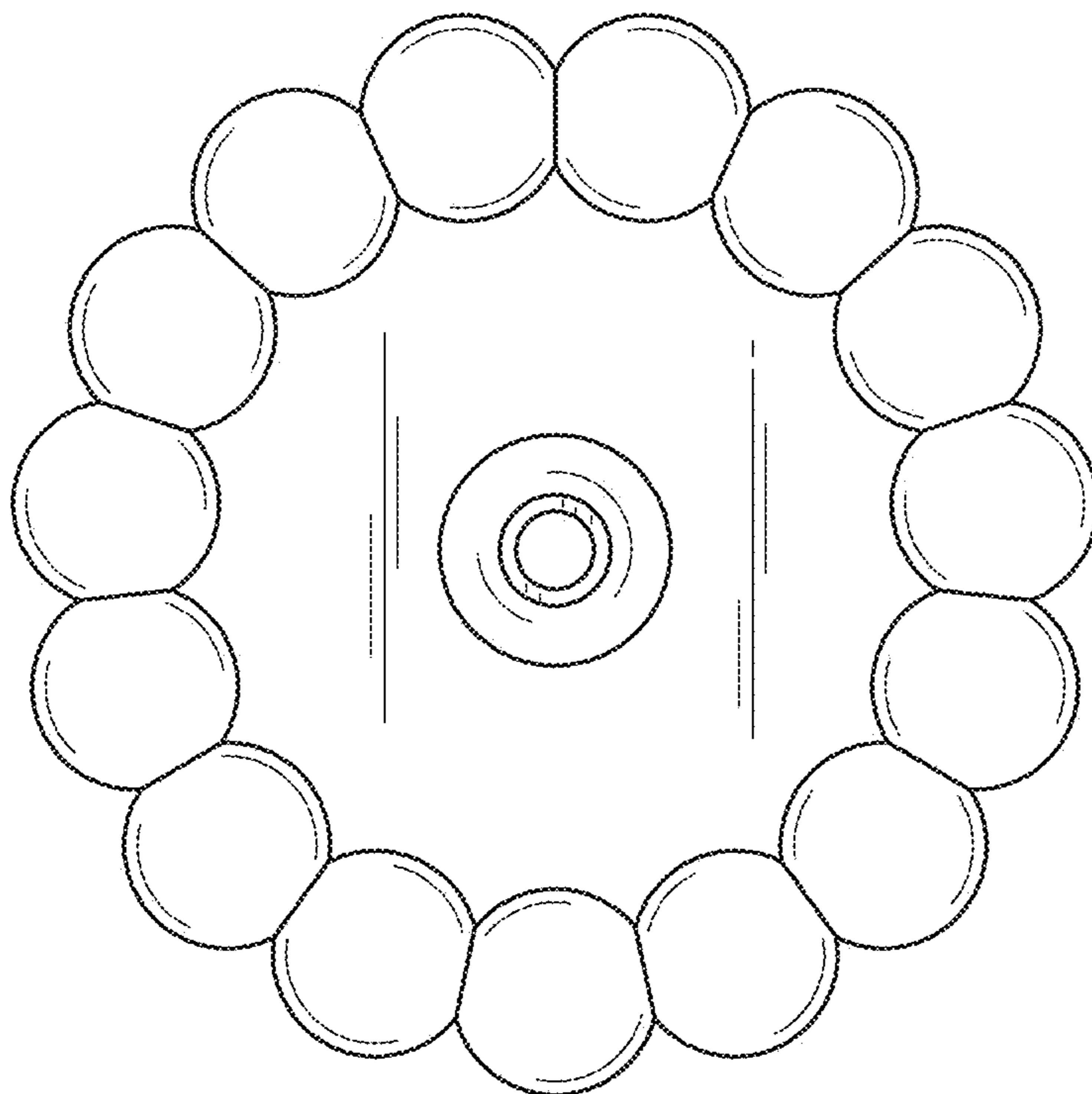

FIG. 161

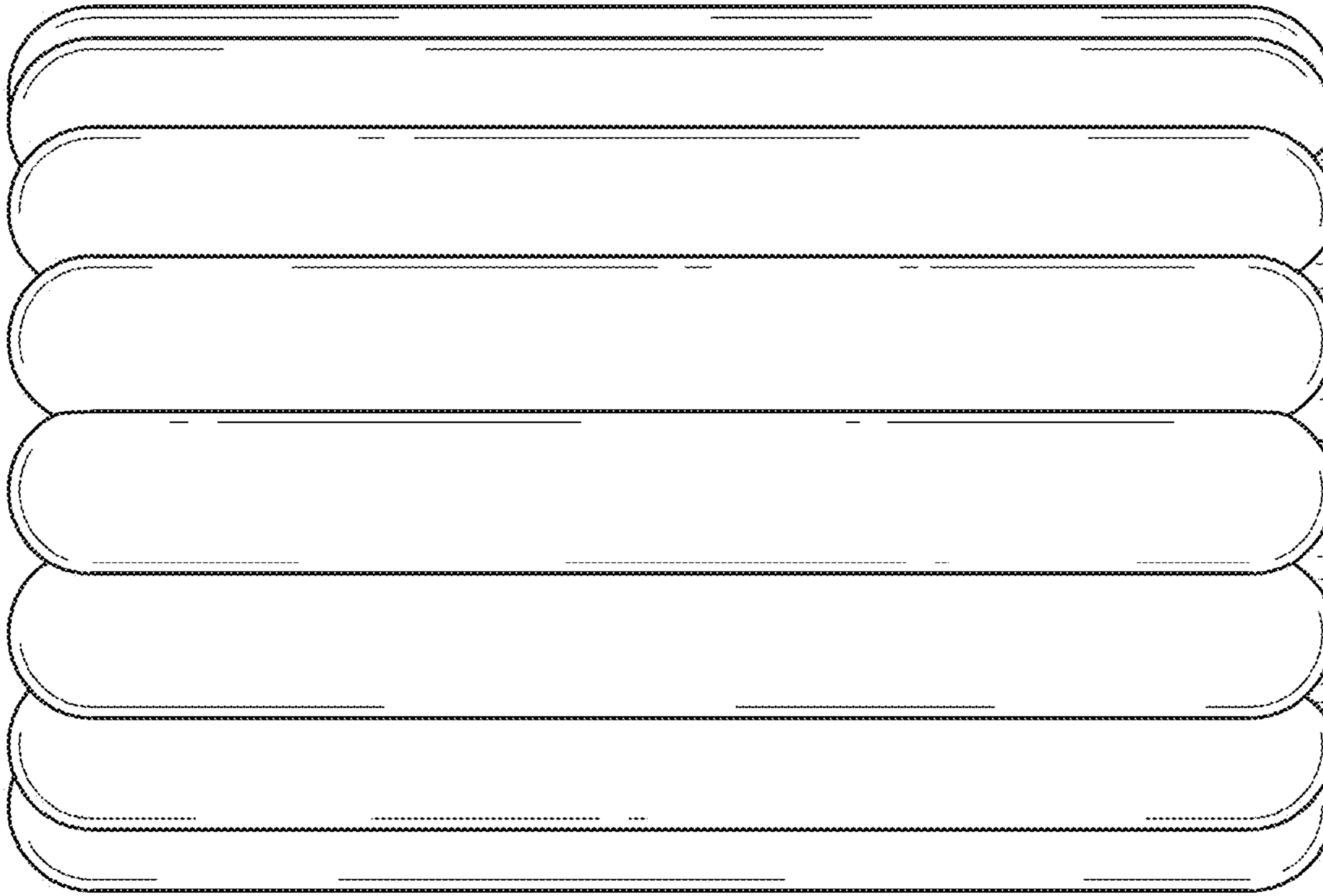

FIG. 164



FIG. 163



FIG. 166



FIG. 165

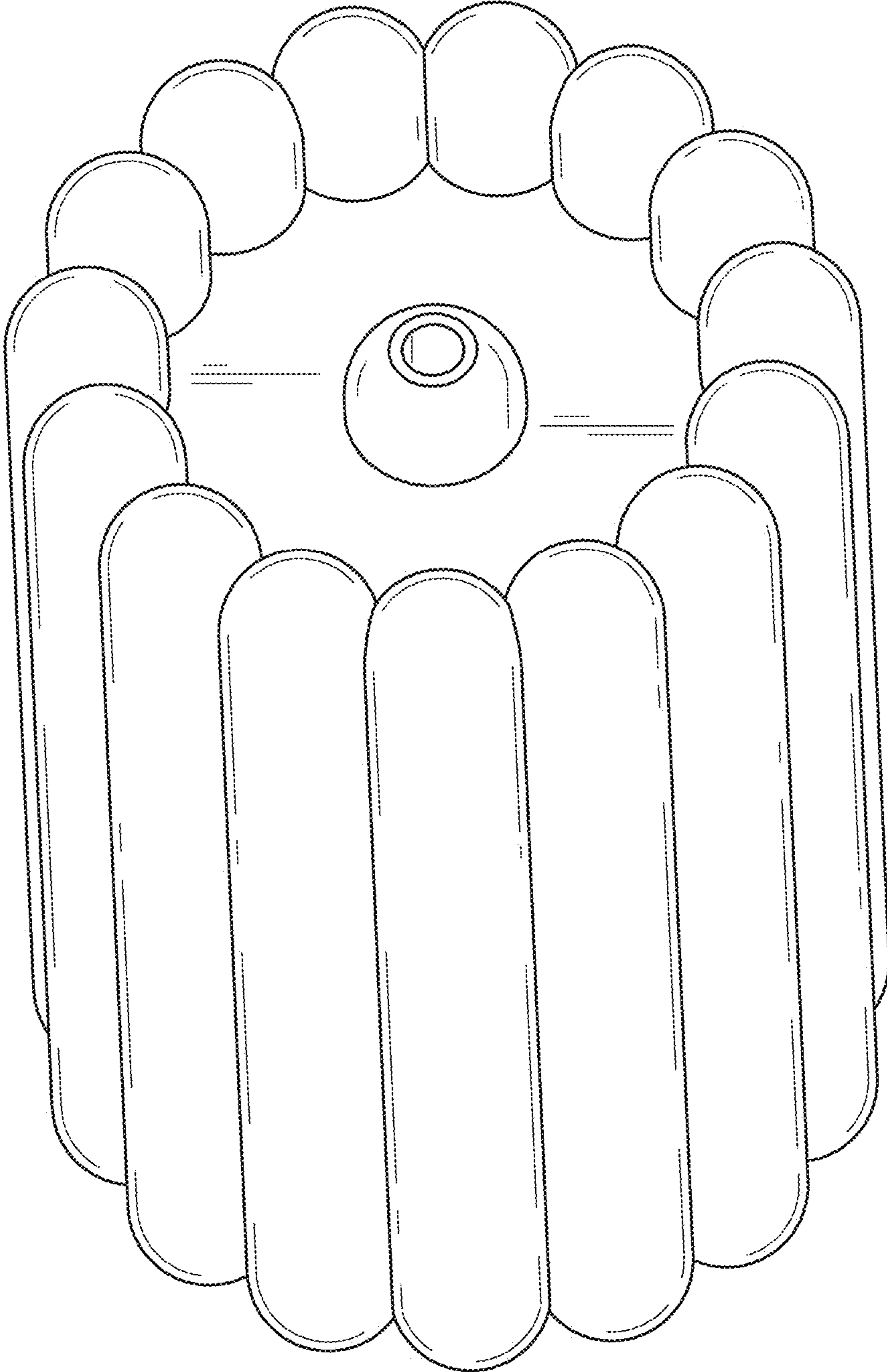

FIG. 167

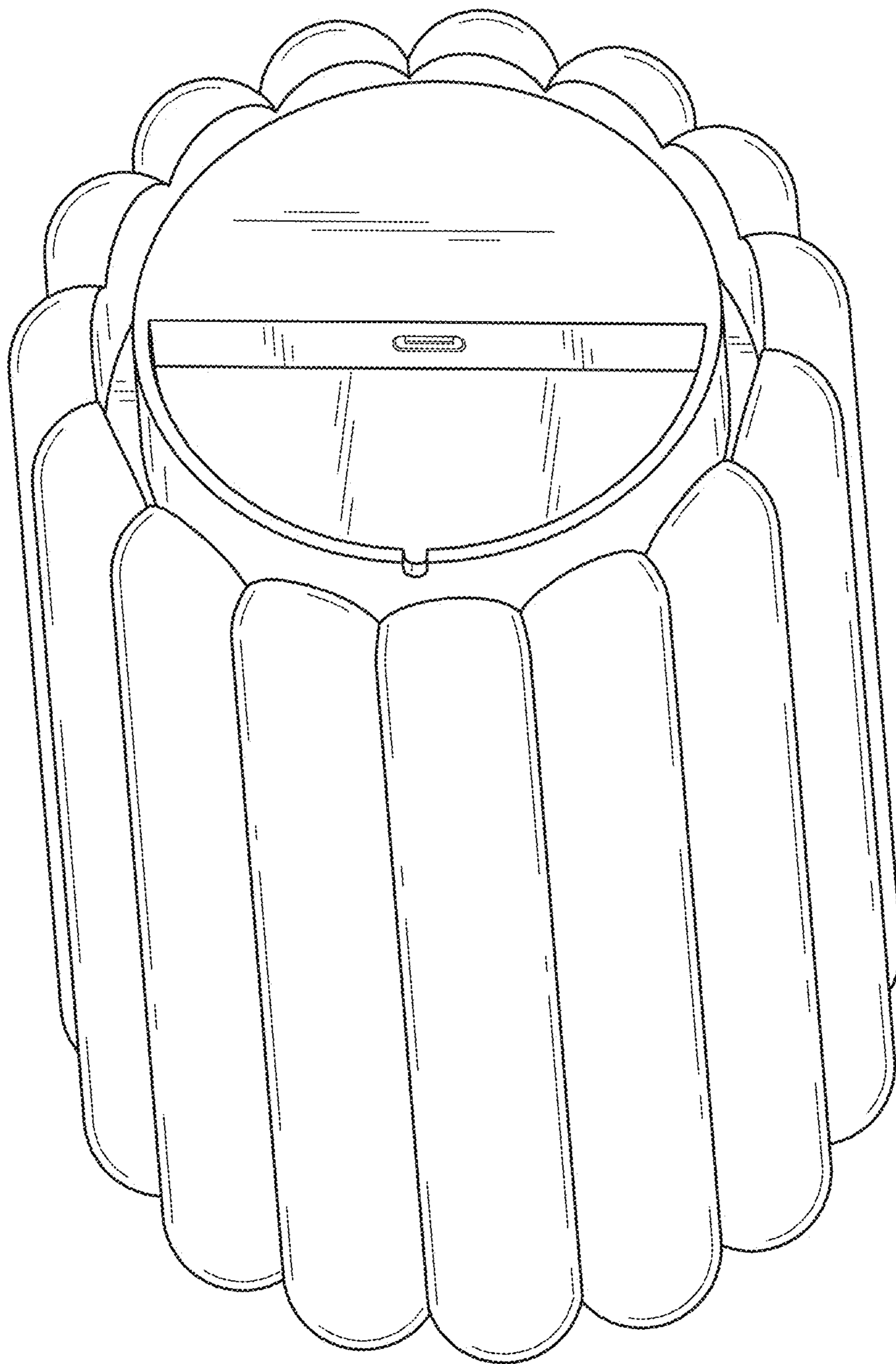

FIG. 168

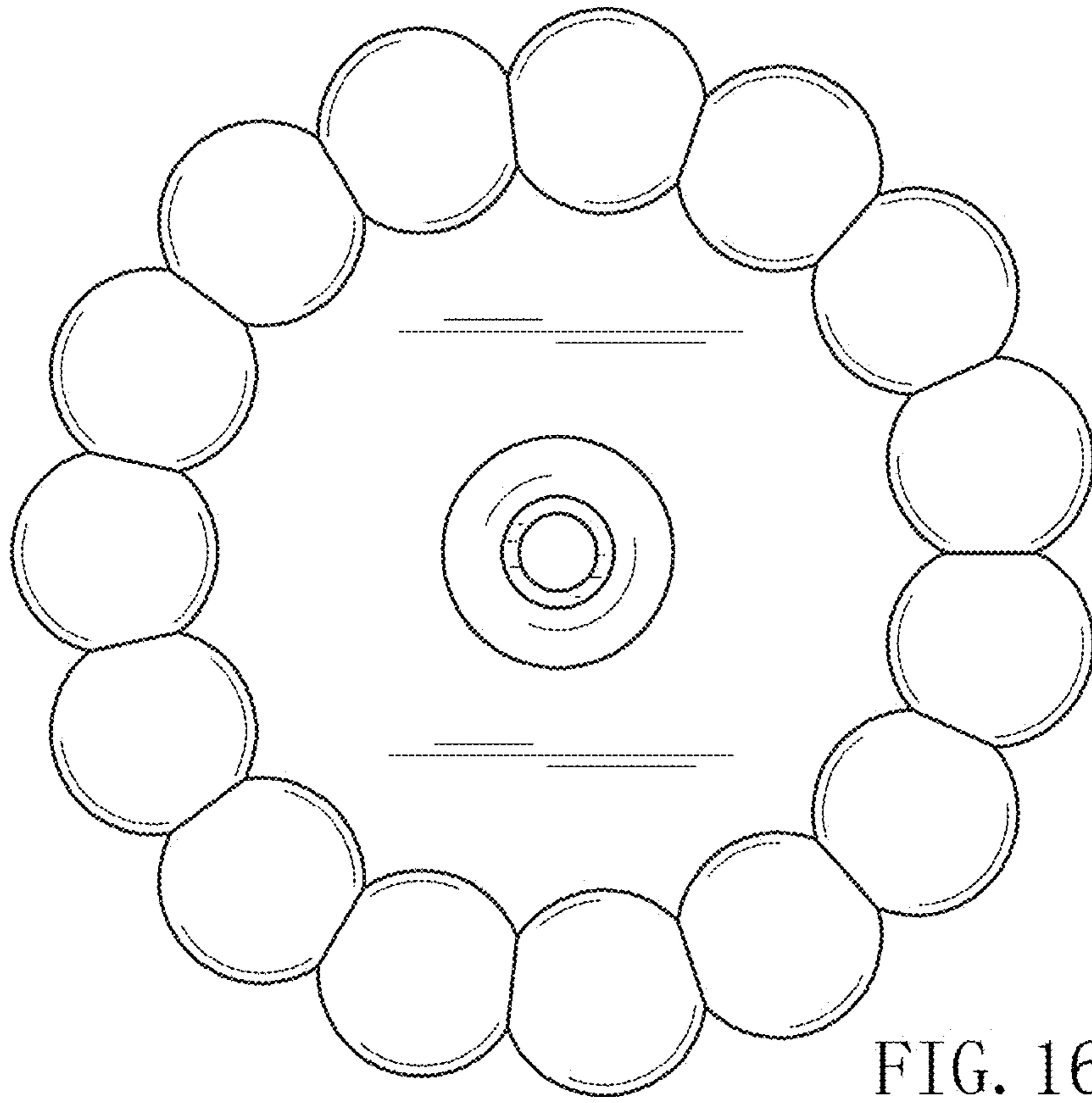

FIG. 169

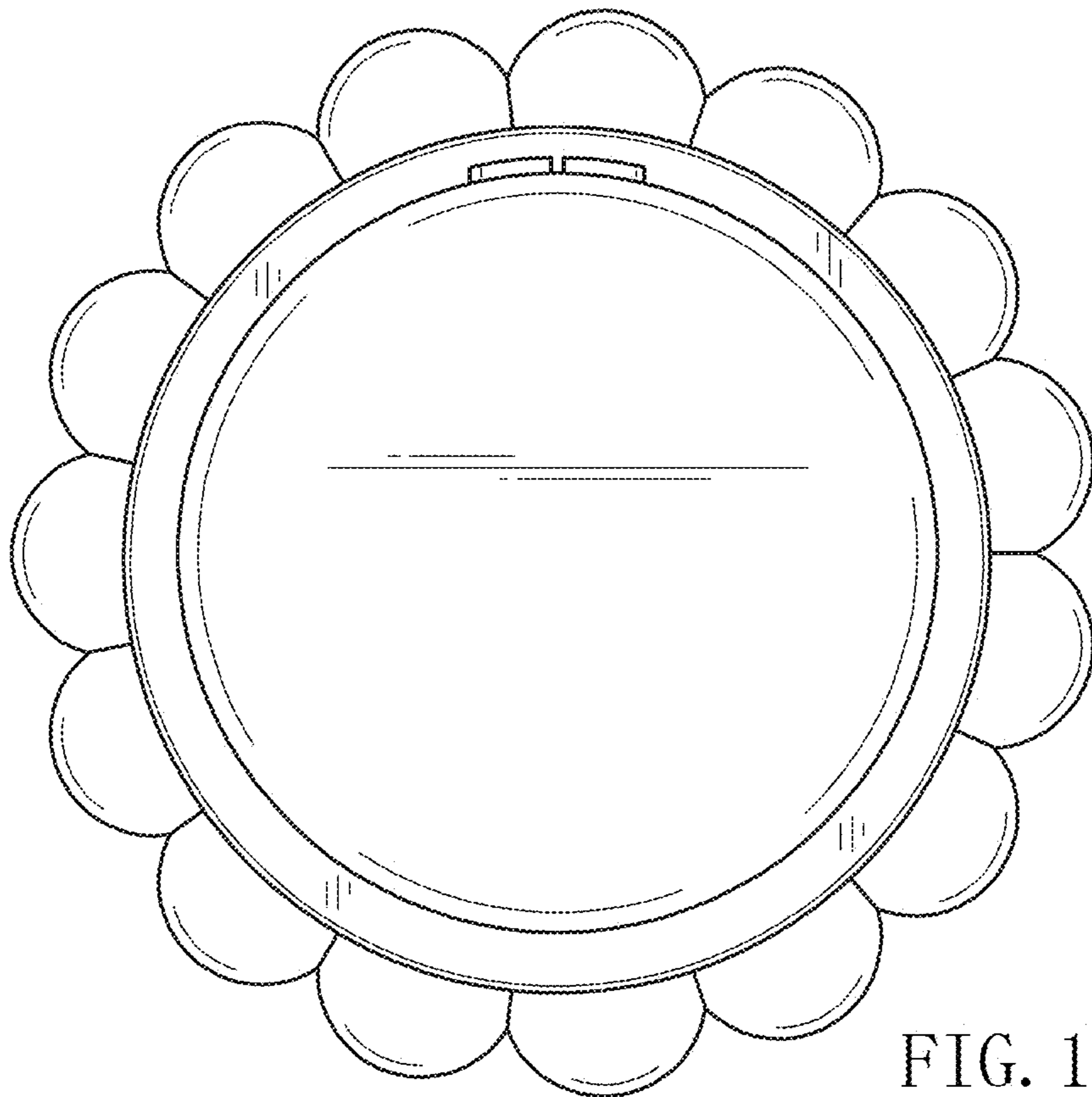

FIG. 170

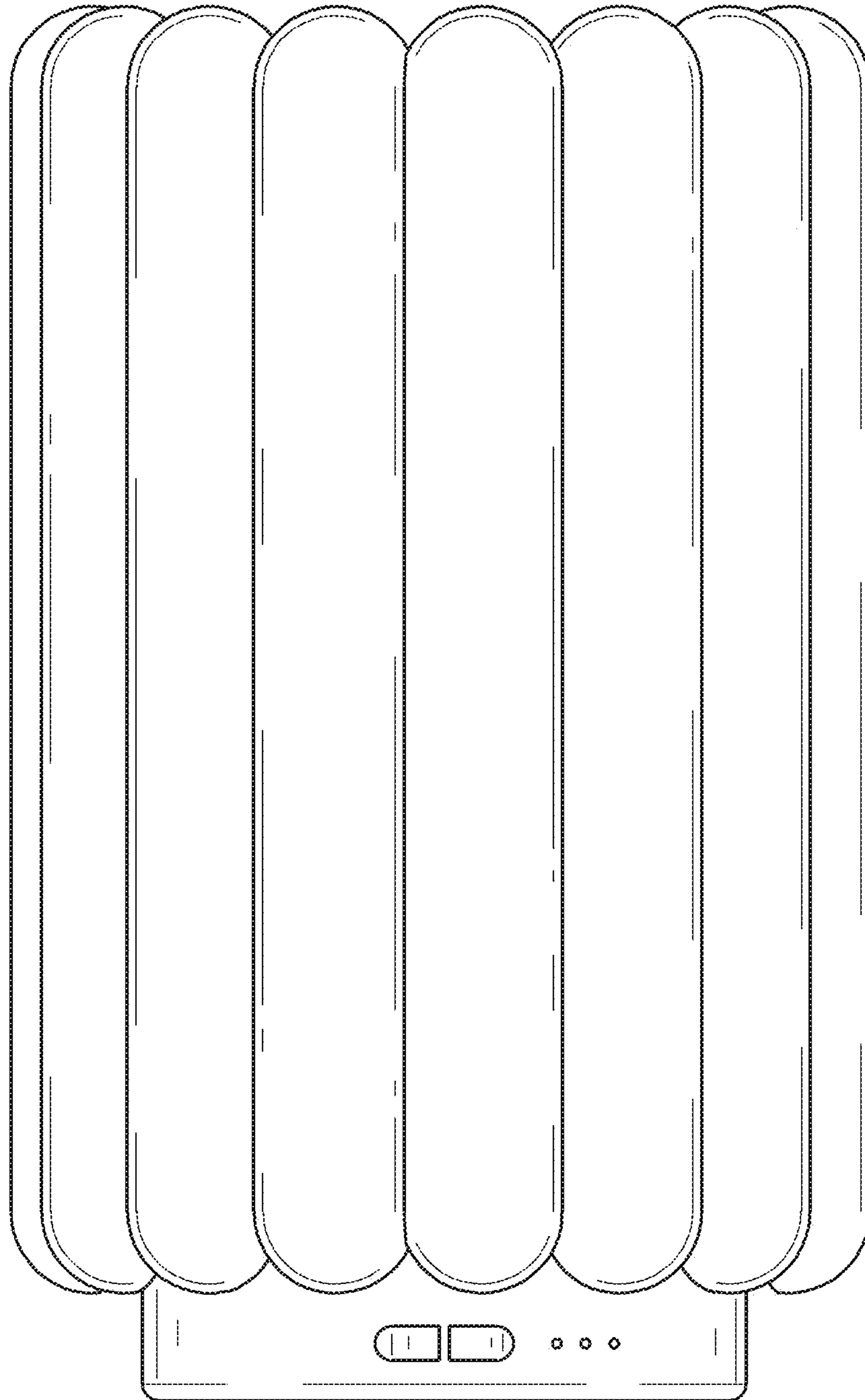

FIG. 171

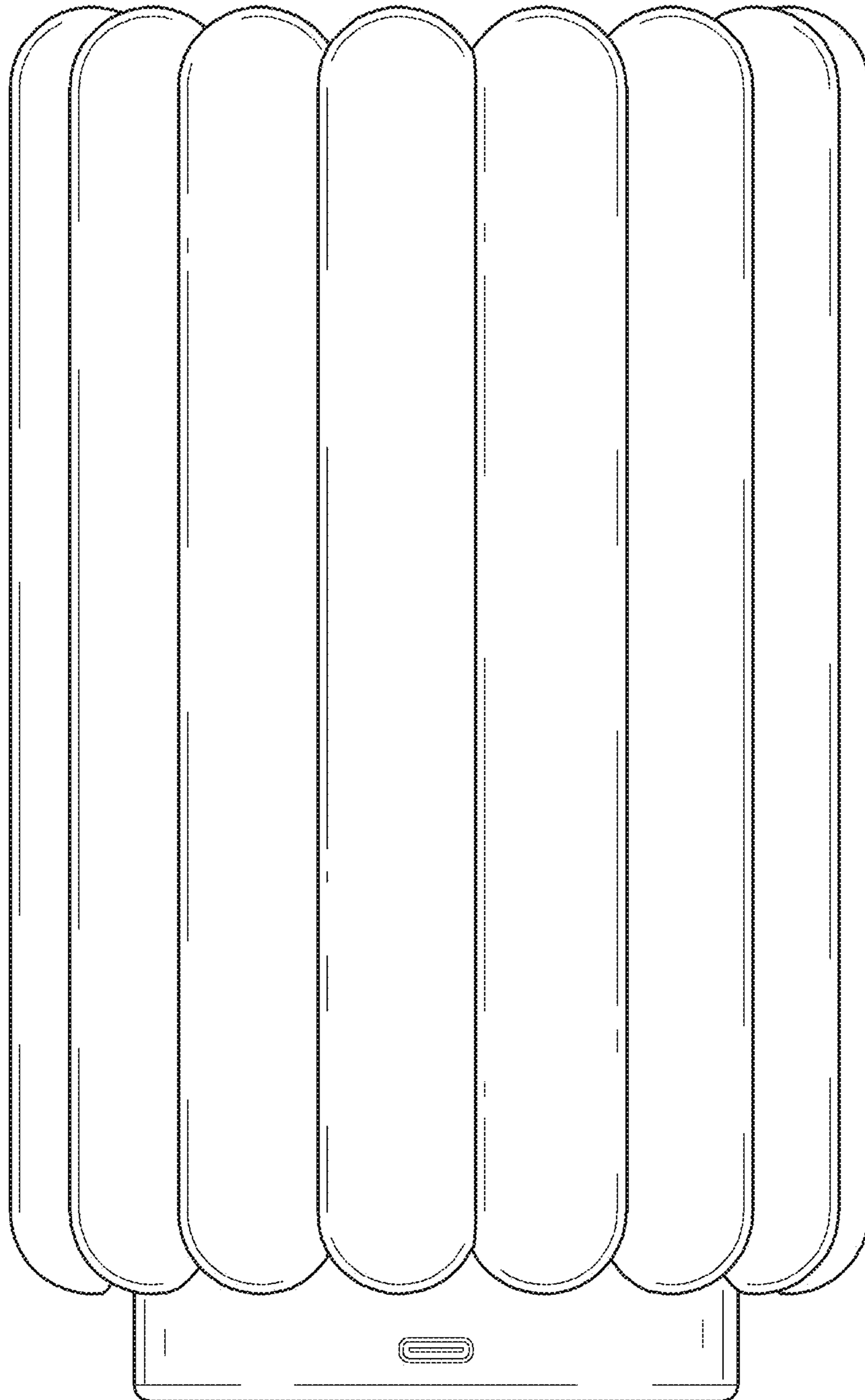

FIG. 172

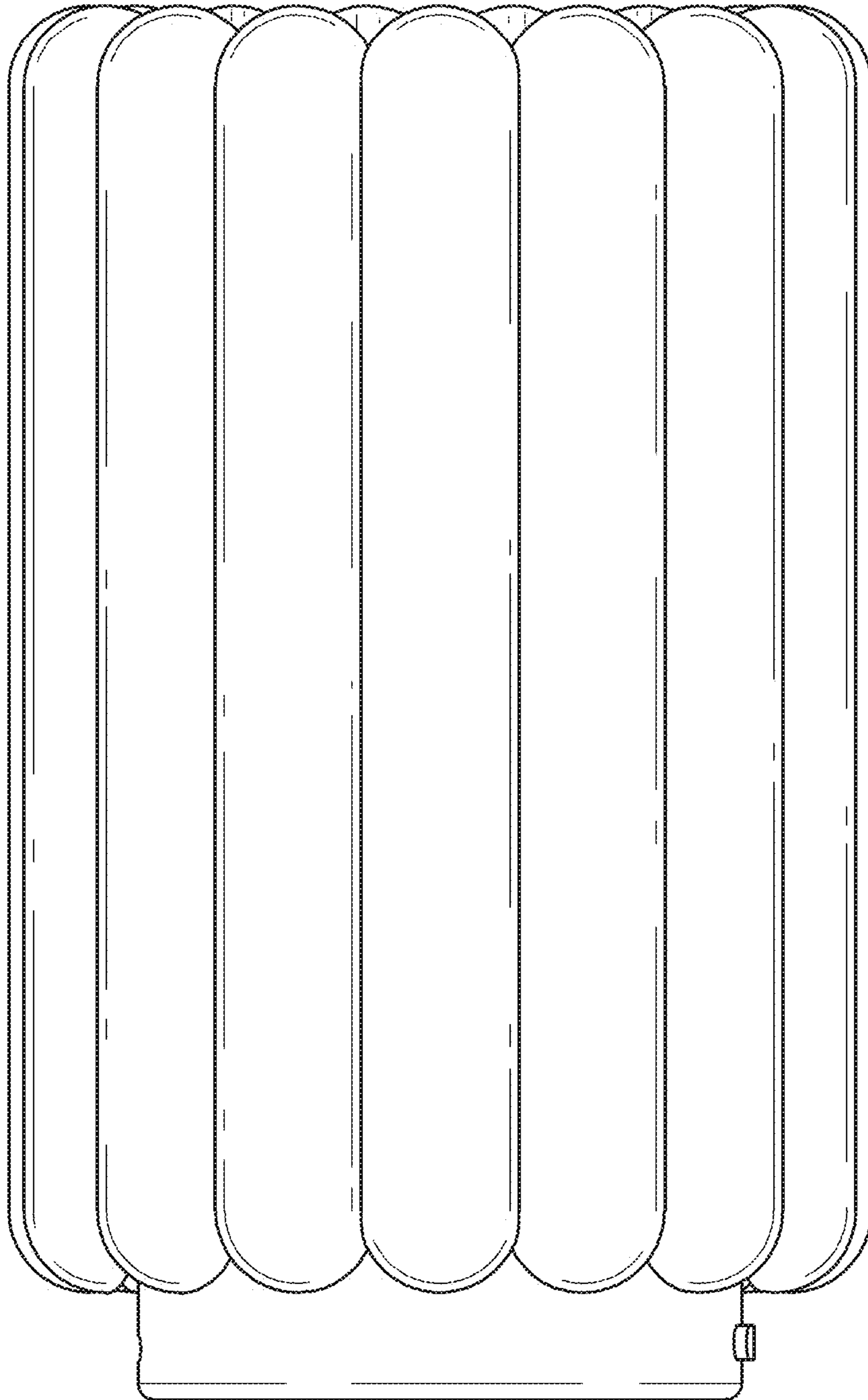

FIG. 173

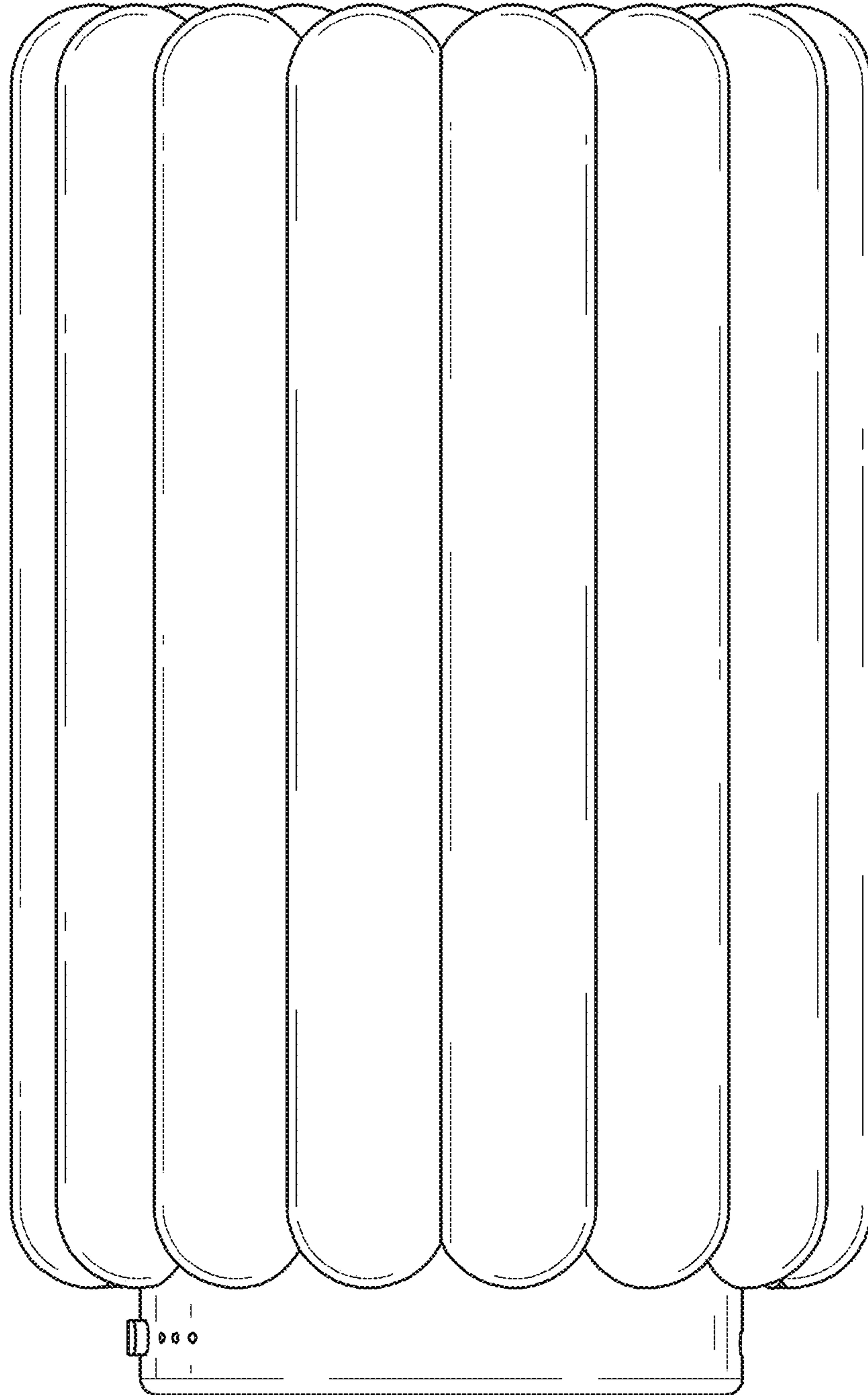

FIG. 174

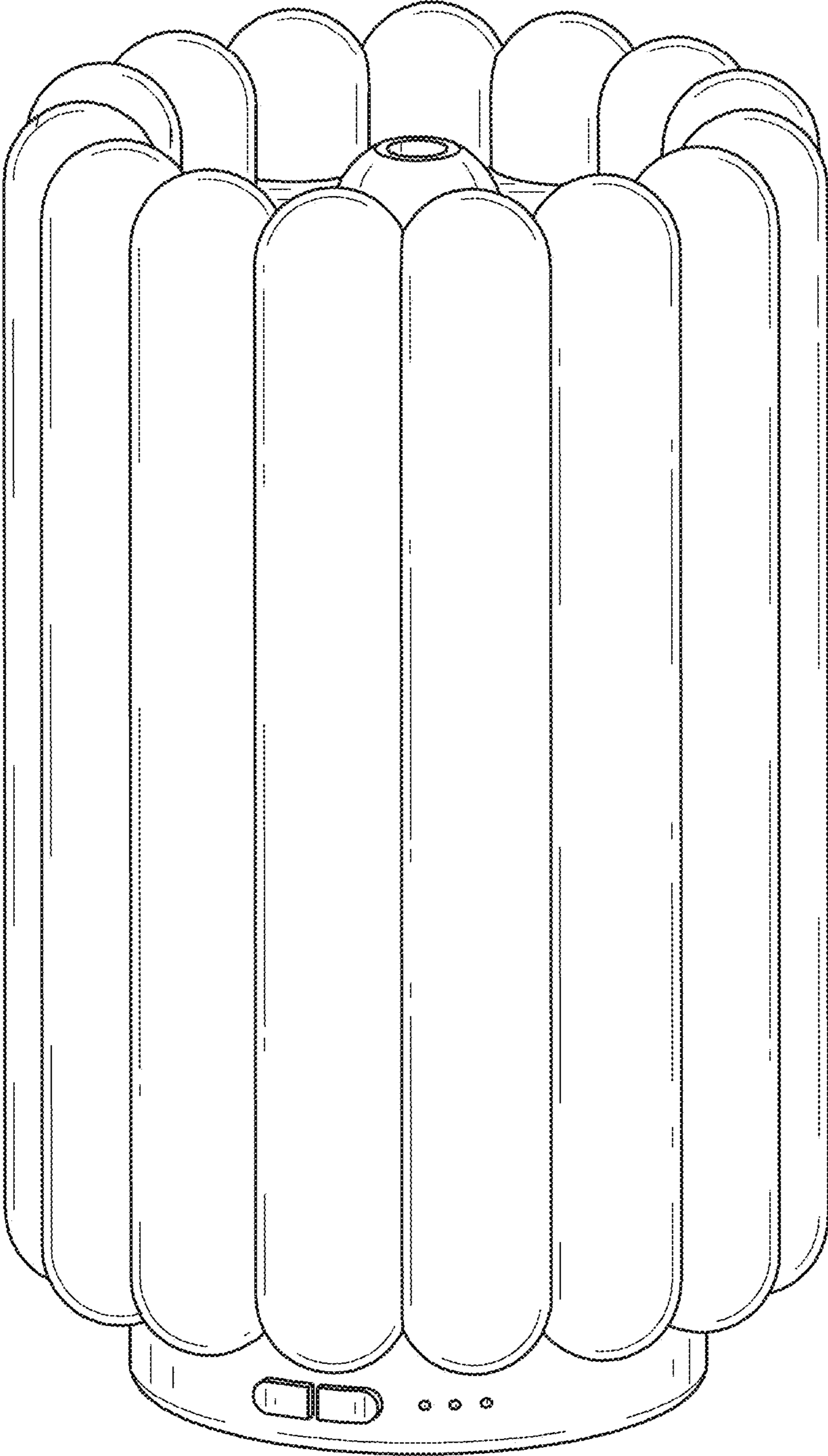

FIG. 175

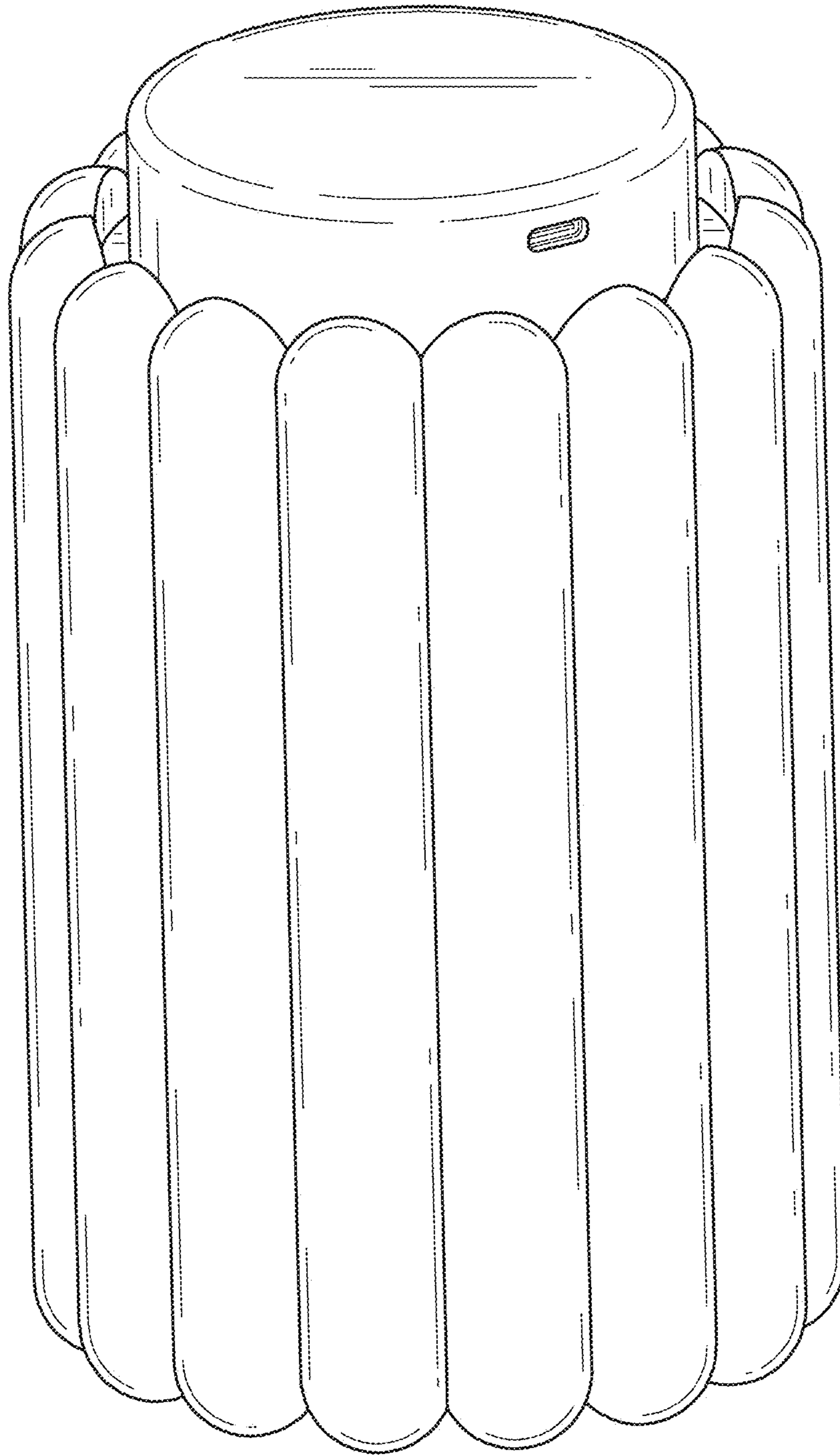

FIG. 176