



US00D983337S

(12) **United States Design Patent**
Chen et al.

(10) **Patent No.:** **US D983,337 S**
(45) **Date of Patent:** **** Apr. 11, 2023**

(54) **AIR CONDITIONER**
(71) Applicant: **EcoFlow Inc.**, Shenzhen (CN)
(72) Inventors: **Xi Chen**, Guangdong (CN); **Haibin Zheng**, Guangdong (CN)
(73) Assignee: **ECOFLOW INC.**, Shenzhen (CN)
(**) Term: **15 Years**
(21) Appl. No.: **35/514,938**
(22) Filed: **May 11, 2022**
(80) **Hague Agreement Data**
Int. Filing Date: **May 11, 2022**
Int. Reg. No.: **DM/222605**
Int. Reg. Date: **May 11, 2022**
Int. Reg. Pub. Date: **Aug. 12, 2022**

D548,822 S * 8/2007 Ni D23/333
D549,308 S * 8/2007 Chiu D23/333
D558,867 S * 1/2008 Chun D23/333
D564,646 S * 3/2008 Chen D23/351
D566,819 S * 4/2008 Chiu D23/333
D572,352 S * 7/2008 Chiu D23/333
D572,809 S * 7/2008 Chiu D23/333
D589,132 S * 3/2009 Chiu D23/333
D590,487 S * 4/2009 Chen D23/333
D590,488 S * 4/2009 Chiu D23/333
D593,663 S * 6/2009 Chiu D23/333
D602,576 S * 10/2009 Gildersleeve D23/333
D612,032 S * 3/2010 Gildersleeve D23/333
D616,081 S * 5/2010 Chiu D23/333
D638,110 S * 5/2011 Zeng D23/333
D644,312 S * 8/2011 Tsuji D23/364
D660,948 S * 5/2012 Varma D23/333
D681,789 S * 5/2013 Chiu D23/333
D699,332 S * 2/2014 Chiu D23/333
D725,758 S * 3/2015 Kim D23/333
D735,843 S * 8/2015 Sunwoo D23/333
D785,150 S * 4/2017 De' Longhi D23/333
D788,894 S * 6/2017 Qin D23/333
D798,427 S * 9/2017 Fan D23/333
9,808,754 B2 * 11/2017 Stoner, Jr. B01D 46/62

(Continued)

(30) **Foreign Application Priority Data**
Feb. 16, 2022 (CN) 202230075716.3
(51) **LOC (14) Cl.** **23-04**
(52) **U.S. Cl.**
USPC **D23/333**
CPC **B01D 46/62** (2022.01)
(58) **Field of Classification Search**
USPC D23/329, 333, 351-354, 388; 55/471,
55/472, 473, DIG. 34
CPC .. B01D 46/62; B01D 46/4254; B01D 46/001;
B01D 46/0086; B01D 46/56; B01D 46/42
See application file for complete search history.

Primary Examiner — Richard E Chilcot
(74) *Attorney, Agent, or Firm* — Anova Law Group,
PLLC

(56) **References Cited**
U.S. PATENT DOCUMENTS
D342,780 S * 12/1993 Pendergrast D23/351
RE34,867 E * 2/1995 Yamazaki F24F 1/04
D23/351
D448,836 S * 10/2001 De' Longhi D23/351
D536,429 S * 2/2007 Bushee D23/333

(57) **CLAIM**
The ornamental design for air conditioner, as shown and described.

DESCRIPTION

- 1. Air conditioner
- 1.1 : Front
- 1.2 : Back
- 1.3 : Left
- 1.4 : Right
- 1.5 : Top
- 1.6 : Bottom
- 1.7 : Perspective
- 1.8 : Perspective

1 Claim, 8 Drawing Sheets

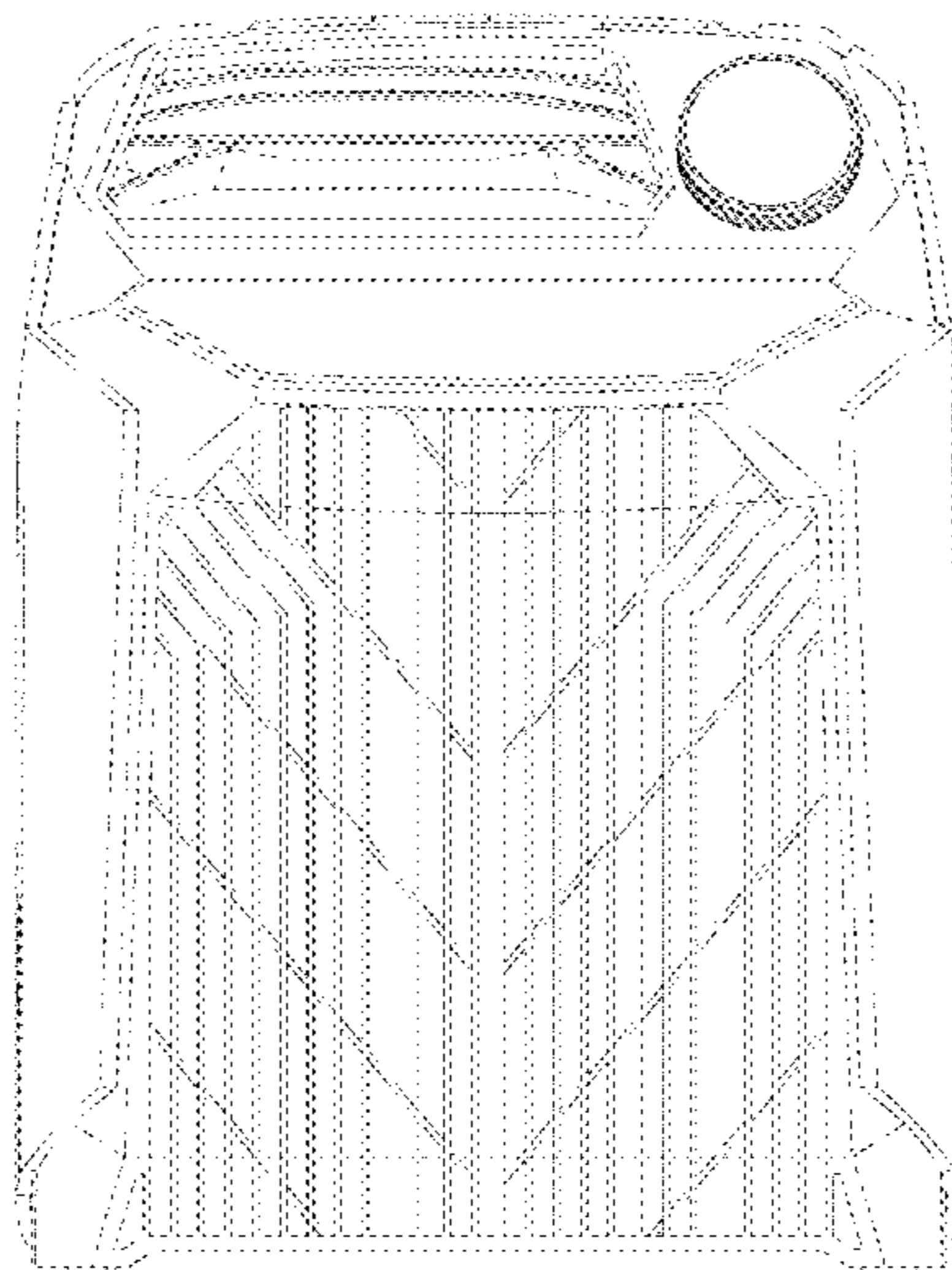

(56)

References Cited

U.S. PATENT DOCUMENTS

9,821,260	B2	*	11/2017	Stoner, Jr.	B01D 46/62
D847,313	S	*	4/2019	Shen	D23/333
D849,220	S	*	5/2019	Fang	D23/351
D859,619	S	*	9/2019	Ogg	D23/333
D882,743	S	*	4/2020	Yang	D23/333
D897,516	S	*	9/2020	Yoon	D23/364
D905,836	S	*	12/2020	Lu	D23/333
D908,852	S	*	1/2021	Zhao	D23/333
D911,502	S	*	2/2021	Chen	D23/329
D924,382	S	*	7/2021	He	D23/333
D933,180	S	*	10/2021	Chen	D23/333
D963,135	S	*	9/2022	Barlettano	D23/333
D963,150	S	*	9/2022	Liu	D23/382
D964,530	S	*	9/2022	Xu	D23/370

* cited by examiner

1.1

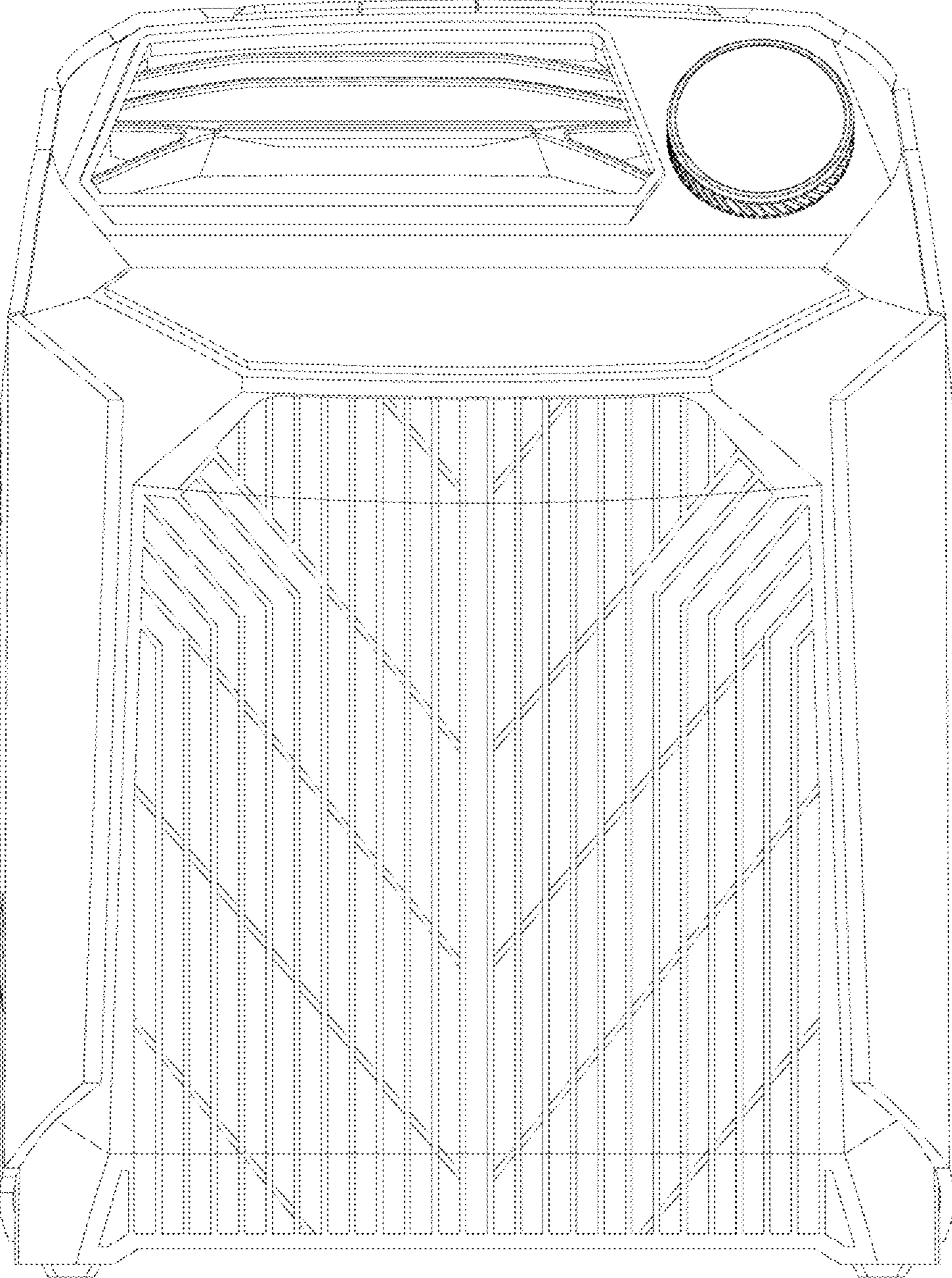

1.2

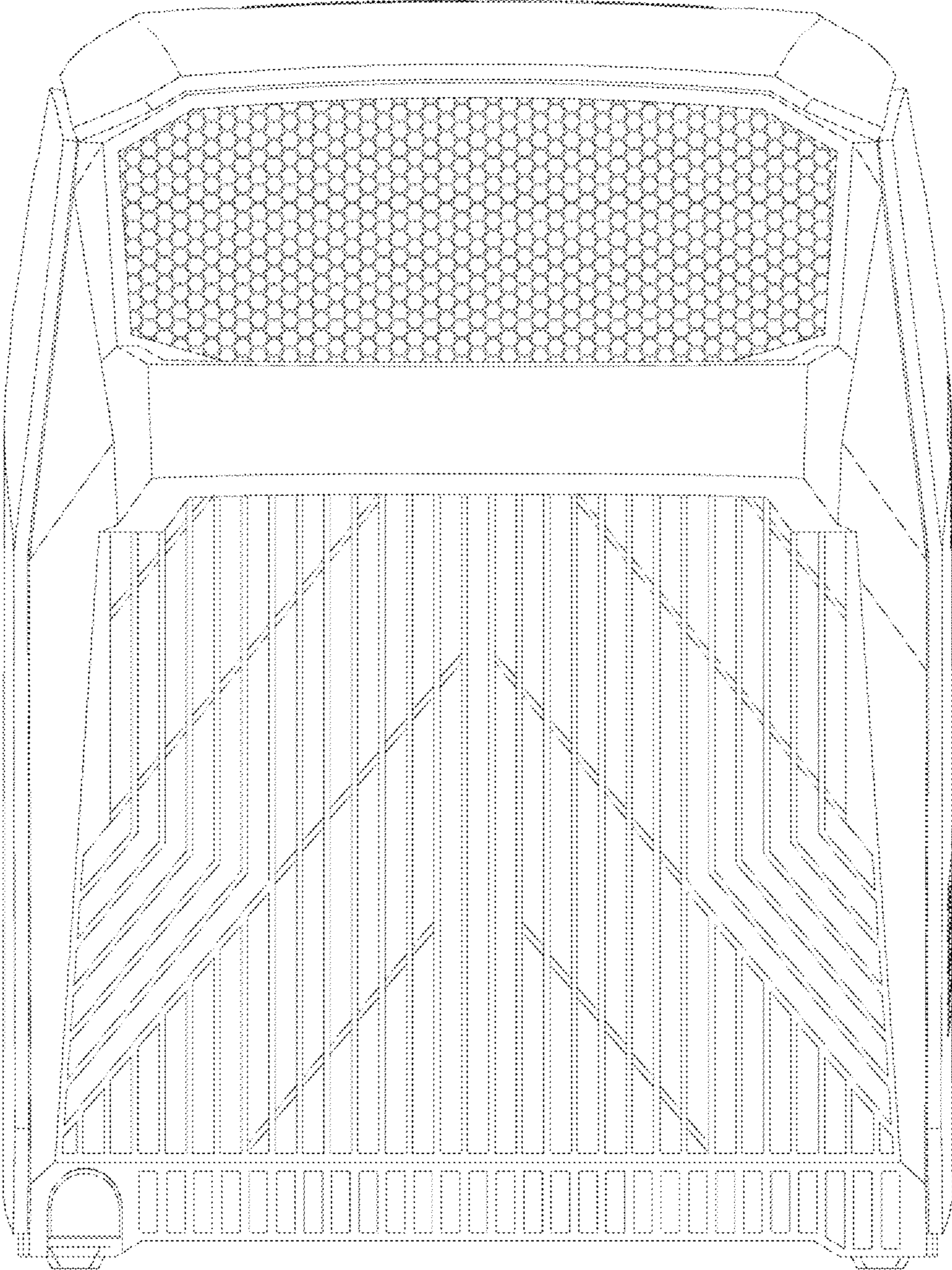

1.3

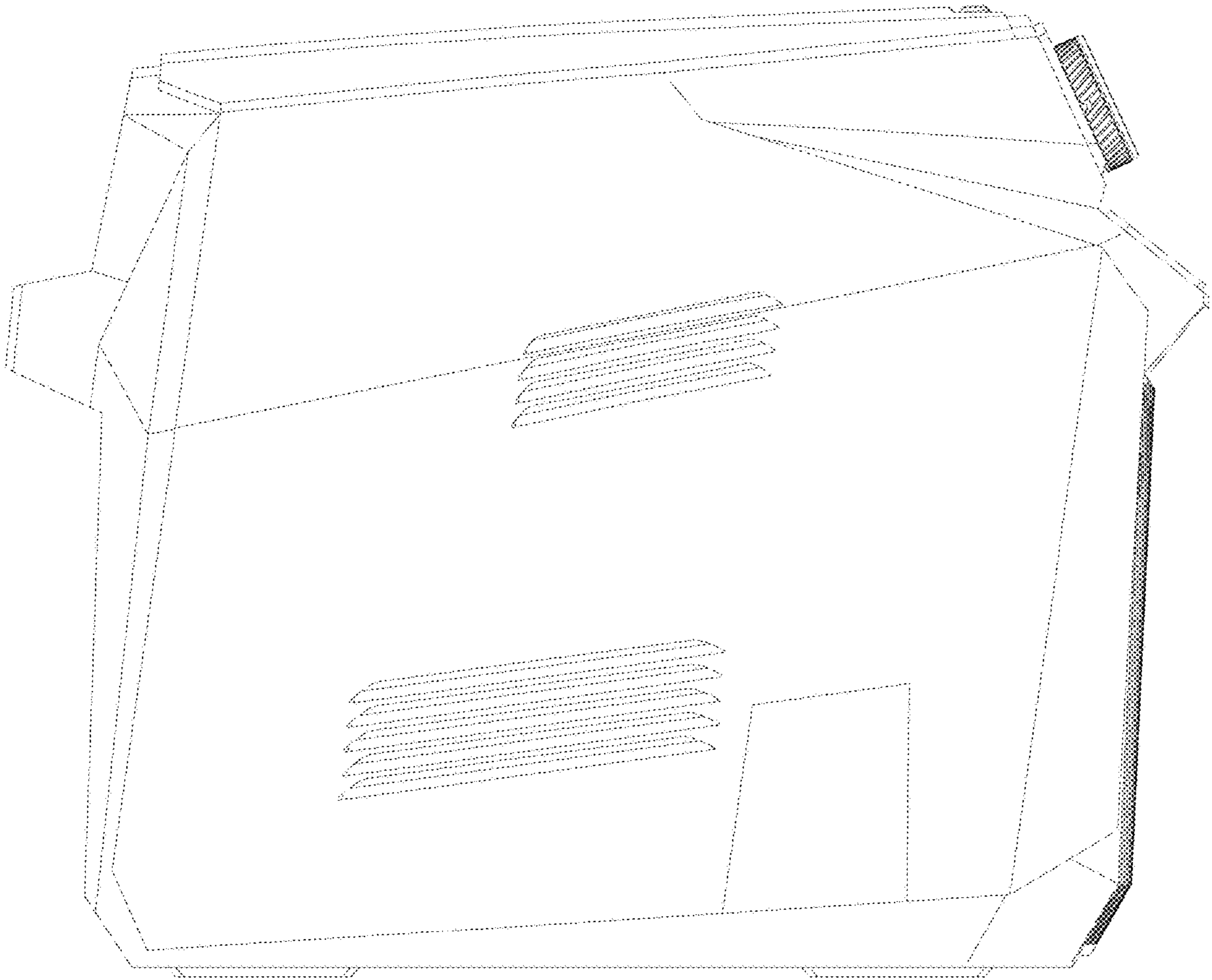

1.4

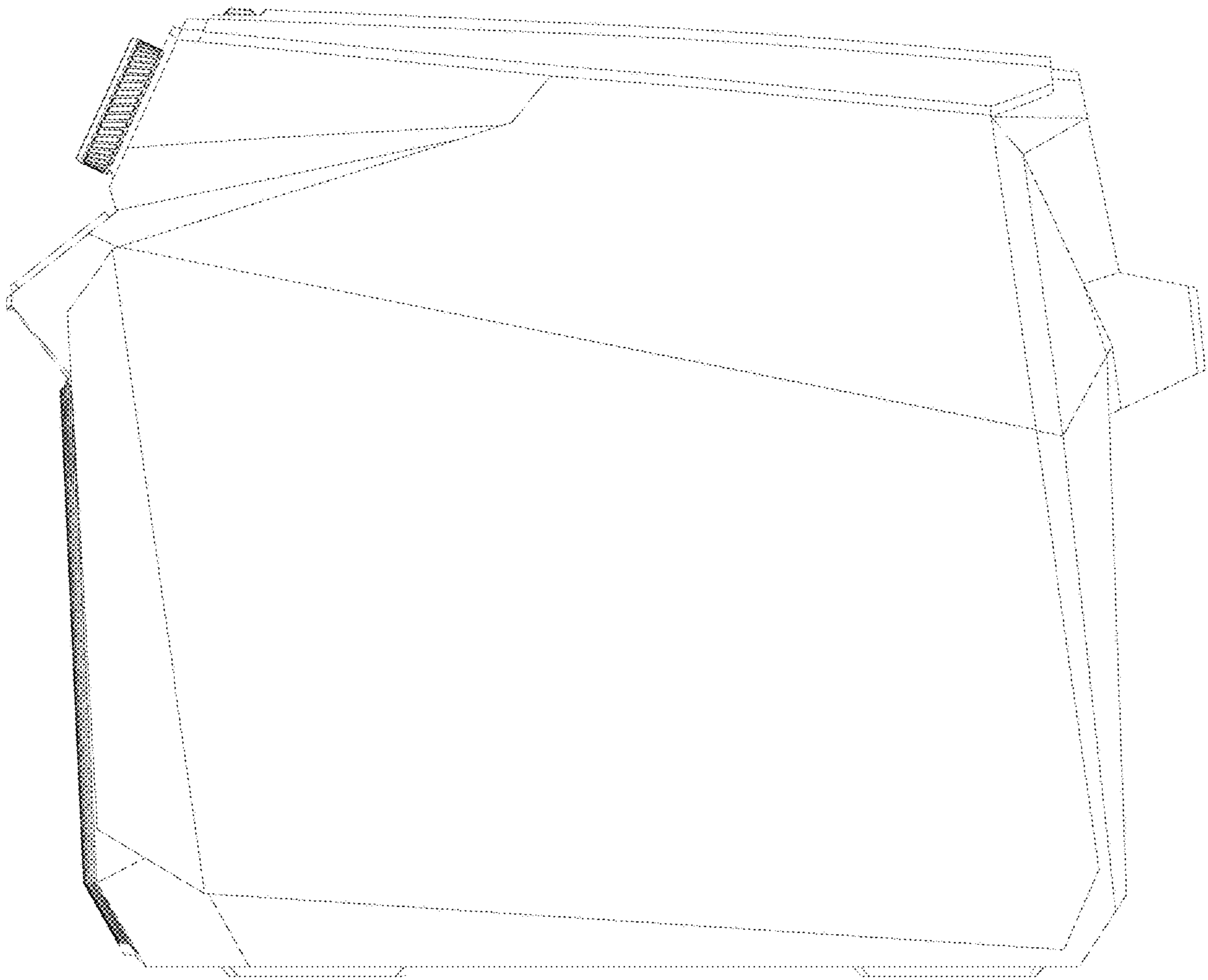

1.5

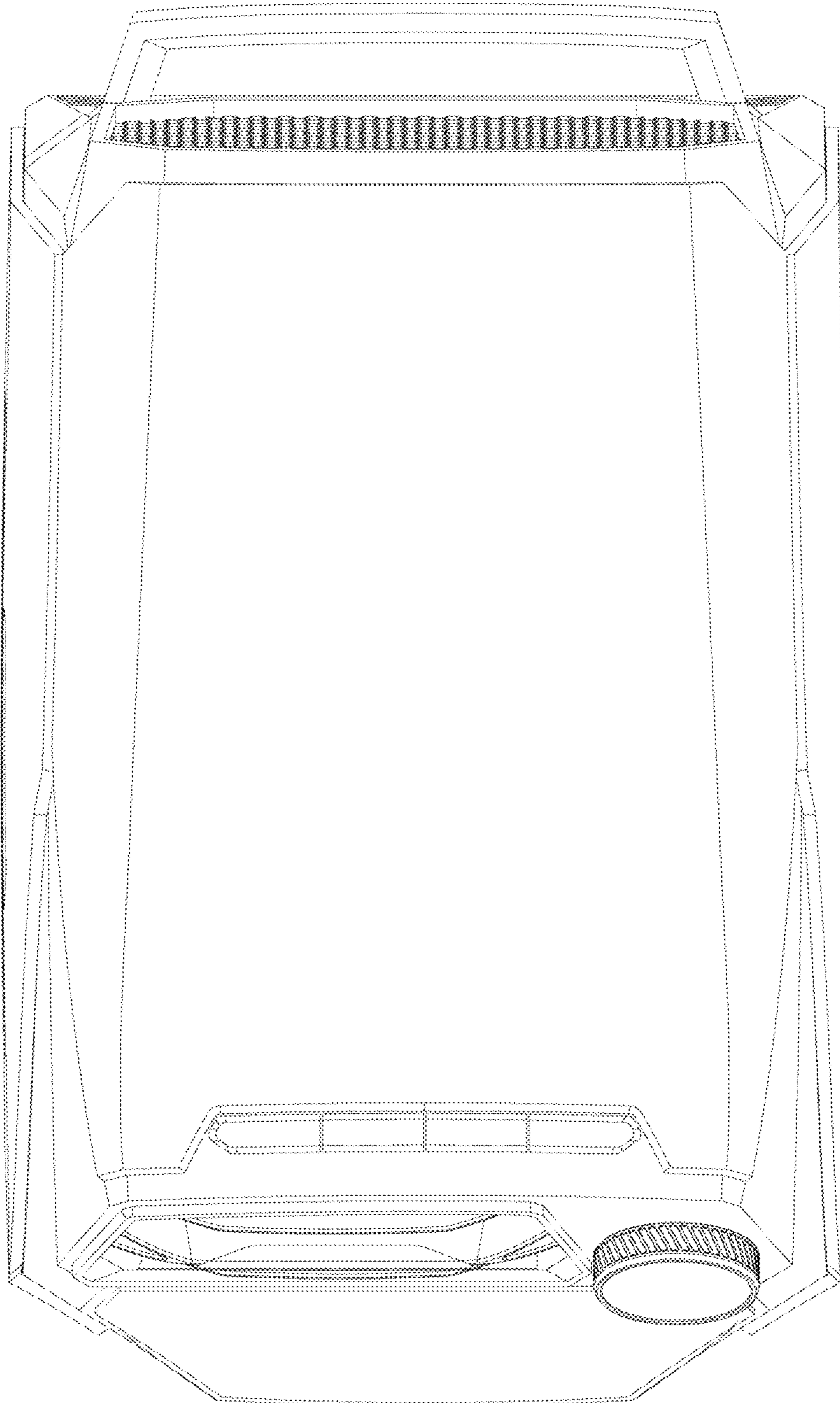

1.6

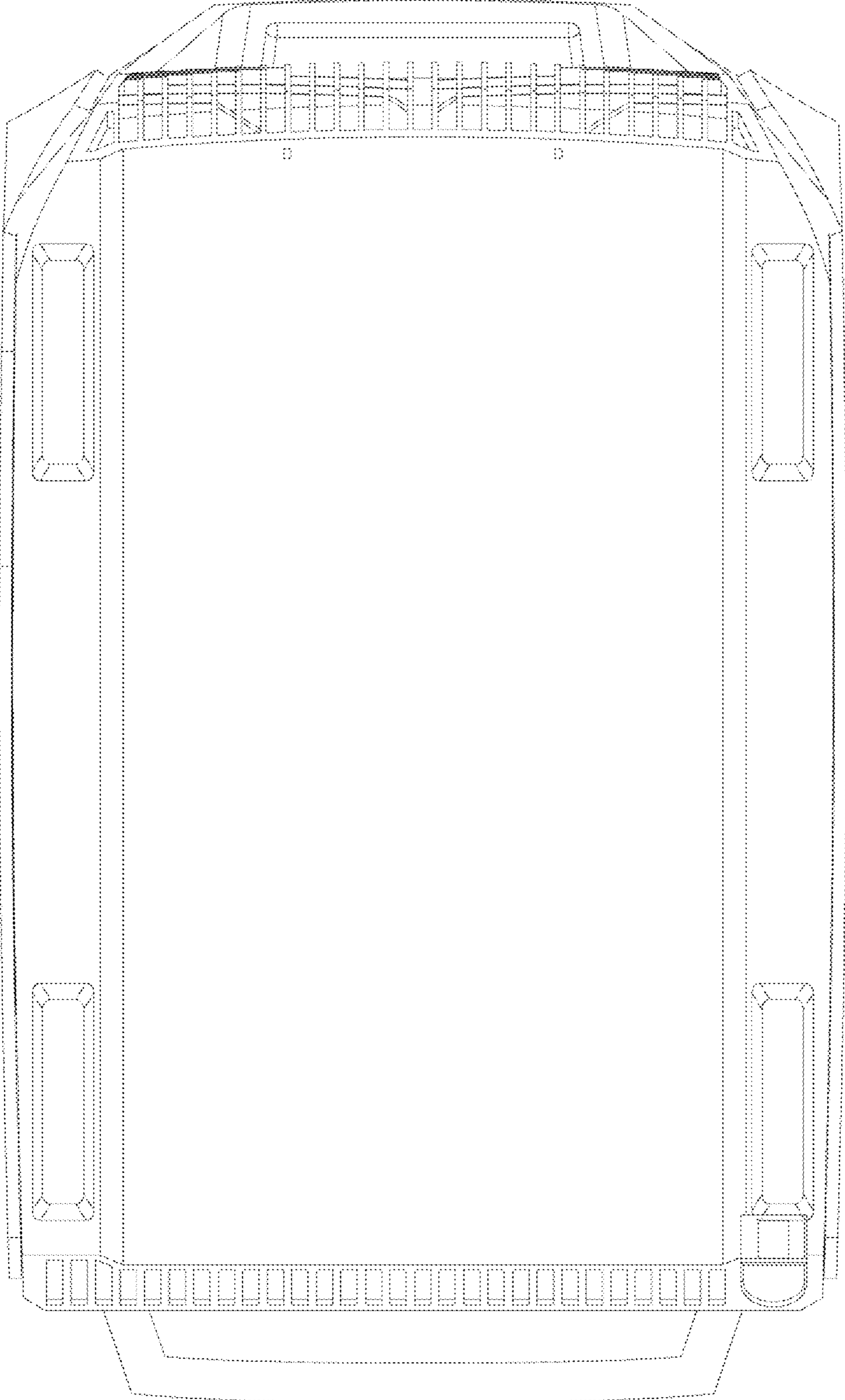

1.7

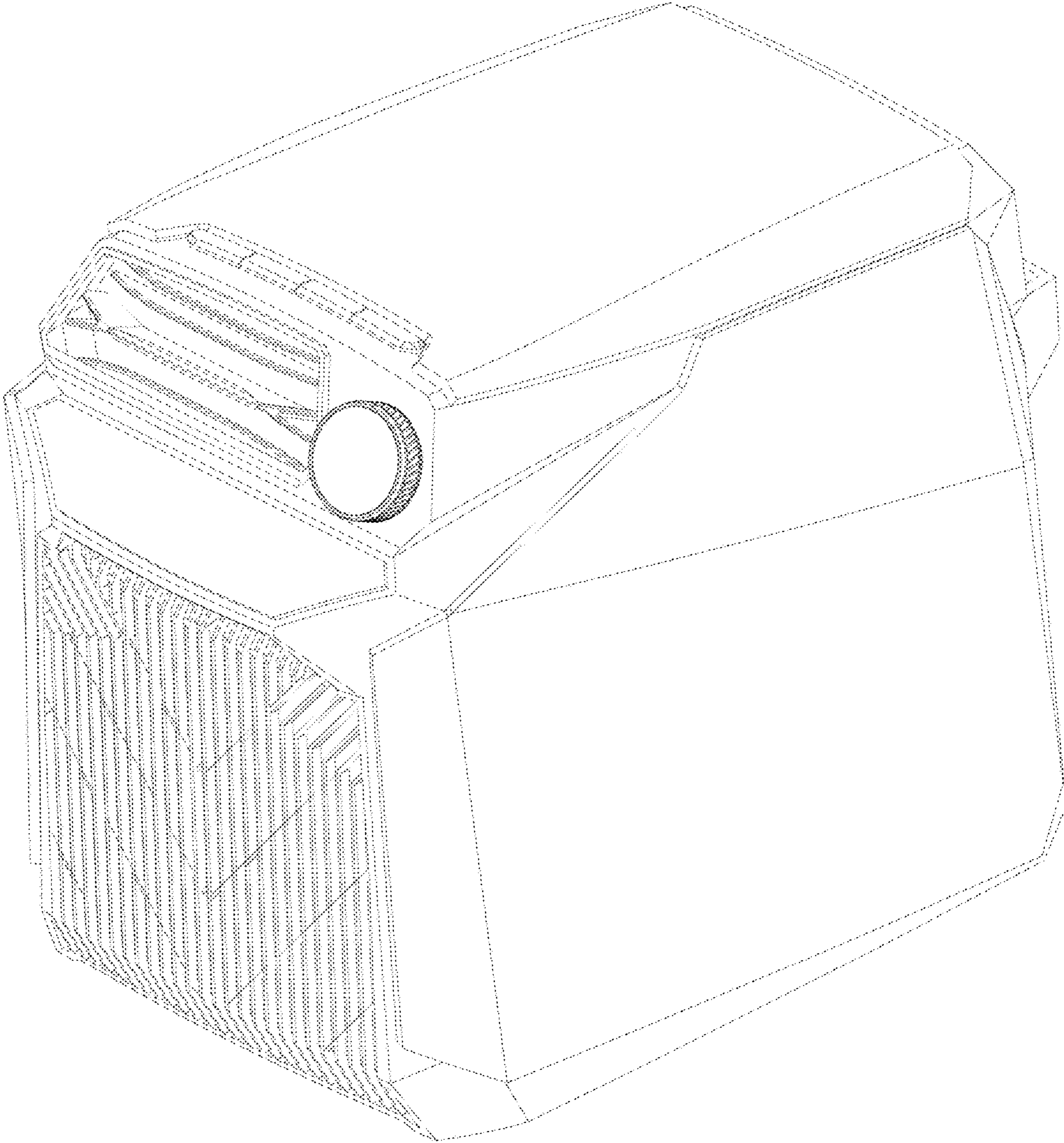

1.8

