



US00D983236S

(12) **United States Design Patent** (10) **Patent No.:** **US D983,236 S**
Chen (45) **Date of Patent:** **** Apr. 11, 2023**

(54) **ICE MACHINE**
(71) Applicant: **Chuanqing Chen**, Jiangsu (CN)
(72) Inventor: **Chuanqing Chen**, Jiangsu (CN)
(**) Term: **15 Years**
(21) Appl. No.: **29/883,443**
(22) Filed: **Jan. 30, 2023**
(51) **LOC (14) Cl.** **15-07**
(52) **U.S. Cl.**
USPC **D15/80**
(58) **Field of Classification Search**
USPC D15/79, 80, 81, 85, 90, 91; D24/216,
D24/217, 219; D7/347
CPC F25C 1/04; F25C 1/10; F25C 1/24; F25C
5/00; F25C 5/20; F25D 17/02; F25D
17/06; F25D 11/003; F25D 19/003; F25D
19/02; F25D 21/04; F25D 2201/14; F25D
2331/803; F25D 2331/805; F25D 23/006;
F25D 23/1028; F25D 23/065; F25D
23/066; F25D 23/085; F25D 2400/20;
F25D 2400/28; F25D 2400/38; F25D
2700/16; F25D 29/00; F25D 29/003;
F25D 29/005; F25D 31/006; F25D
31/007
See application file for complete search history.

D781,930 S * 3/2017 Ward D15/79
D906,536 S * 12/2020 Kozono D24/216
D937,909 S * 12/2021 Pan D15/80
D955,446 S * 6/2022 Lin D15/79
D959,190 S * 8/2022 Liu D7/350.2
D971,277 S * 11/2022 Hu D15/80
D973,724 S * 12/2022 Shen D15/79
D976,905 S * 1/2023 Knatt D15/89
2019/0128915 A1 * 5/2019 Yamamoto B01L 9/527

OTHER PUBLICATIONS

Yueye, Countertop Ice Maker, (first available Sep. 17, 2022), Amazon.com, URL:<<https://www.amazon.com/YUEYE-Countertop-Maker-Minutes-Low-Noise/dp/B0BFKNYVD4>> (Year: 2022).*

(Continued)

Primary Examiner — Calvin E Vasant
Assistant Examiner — Mark T. Philipps
(74) *Attorney, Agent, or Firm* — Kunzler Bean & Adamson, PC; Michael Bartholomew

(57) **CLAIM**

The ornamental design for an ice machine, as shown and described.

DESCRIPTION

FIG. 1 is a front, right and top perspective view of an ice machine, showing my design.
FIG. 2 is a rear, left and bottom perspective view thereof.
FIG. 3 is a front elevation view thereof.
FIG. 4 is a rear elevation view thereof.
FIG. 5 is a left side elevation view thereof.
FIG. 6 is a right side elevation view thereof.
FIG. 7 is a top plan view thereof; and,
FIG. 8 is a bottom plan view thereof.
The broken lines depict portions of the ice machine that form no part of the claimed design.

1 Claim, 8 Drawing Sheets

(56) **References Cited**
U.S. PATENT DOCUMENTS
D375,432 S * 11/1996 Hamada D7/350.2
D527,462 S * 8/2006 Raimann D24/219
D541,102 S * 4/2007 Matsuda D7/350.2
D649,565 S 11/2011 Lafond et al.
D653,682 S 2/2012 Herning et al.
D660,976 S * 5/2012 Henssler D24/219
D738,156 S * 9/2015 Saltet D7/350.2

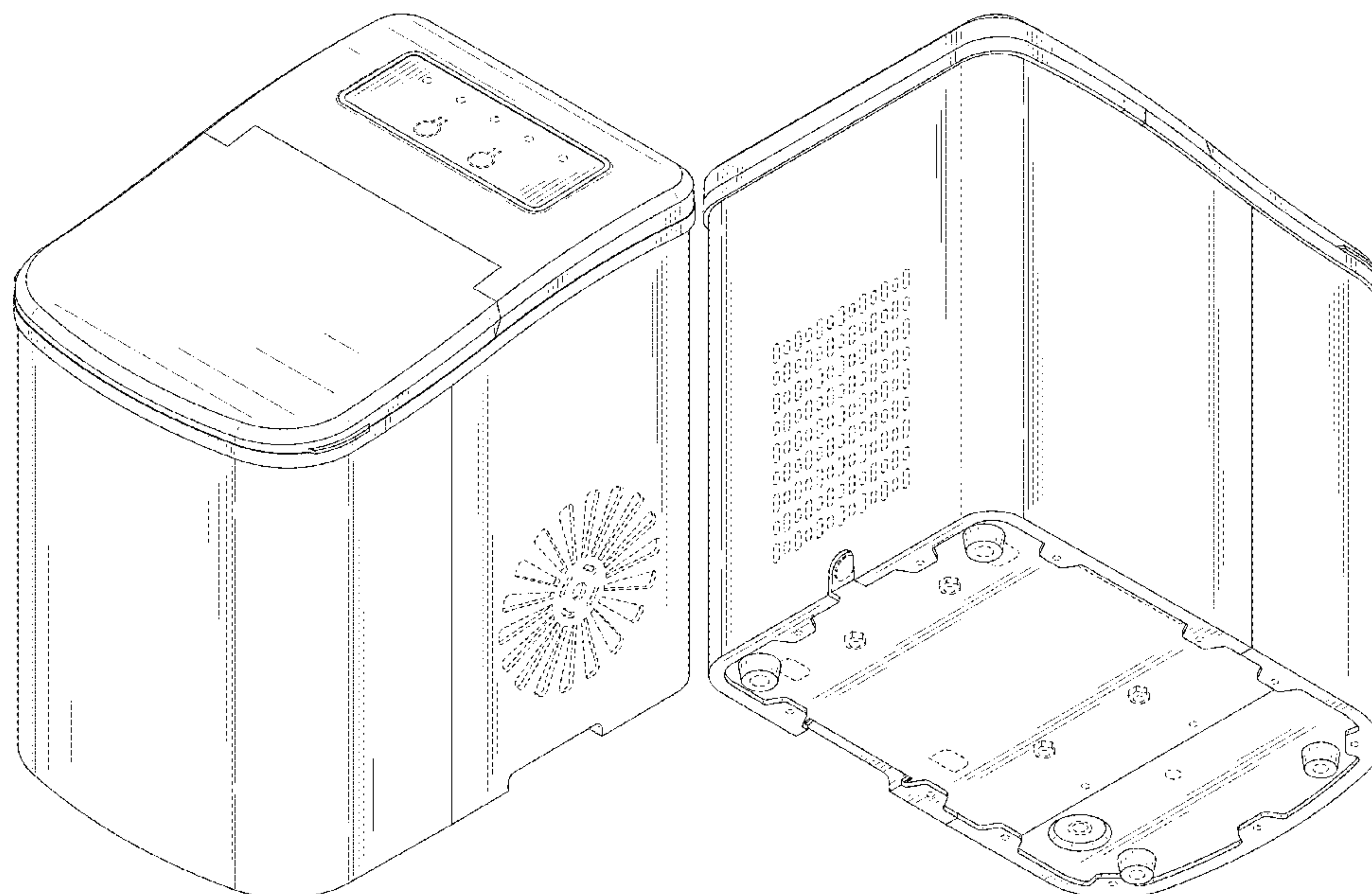

(56)

References Cited

OTHER PUBLICATIONS

Vecys, Upgraded Ice Maker, (first available Jul. 30, 2021), Amazon.com, URL:<<https://www.amazon.com/VECYS-Upgraded-Countertop-Self-Clean-Champagne/dp/B09BJ5SK4X>> (Year: 2021).*

Silonn, Countertop Ice Maker (SLIM09),(first available Jul. 29, 2022), Amazon.com, URL:<<https://www.amazon.com/dp/B0B5D97F23>> (Year: 2022).*

Silonn, Countertop Ice Maker Machine, (first available May 20, 2022), Amazon.com, URL:<<https://www.amazon.com/dp/B0B1TC5SDQ>> (Year: 2022).*

Igloo, Electric Countertop Ice Maker Machine, (first available Mar. 11, 2022), Amazon.com, URL:<<https://www.amazon.com/Igloo-Automatic-Portable-Electric-Countertop/dp/B09VCVV8TG>> (Year: 2022).*

DyBaxa, 33Lbs/24Hrs Ice Makers Countertop, (first available Sep. 30, 2022), Amazon.com, URL:<<https://www.amazon.com/DyBaxa-Countertop-Touch-Screen-Portable-Self-Cleaning/dp/B0B4JN9145>> (Year: 2022).*

Freezimer, Ice Maker Machine for Countertop, (first available May 23, 2022), Amazon.com, URL:<<https://www.amazon.com/dp/B0B1ZV4LS6>> (Year: 2022).*

Aglucky, Countertop Ice Maker Machine, (first available Nov. 21, 2019), Amazon.com, URL:<<https://www.amazon.com/AGLUCKY-Machine-Countertop-Portable-Makers/dp/B08FZYMWJT>> (Year: 2019).*

* cited by examiner

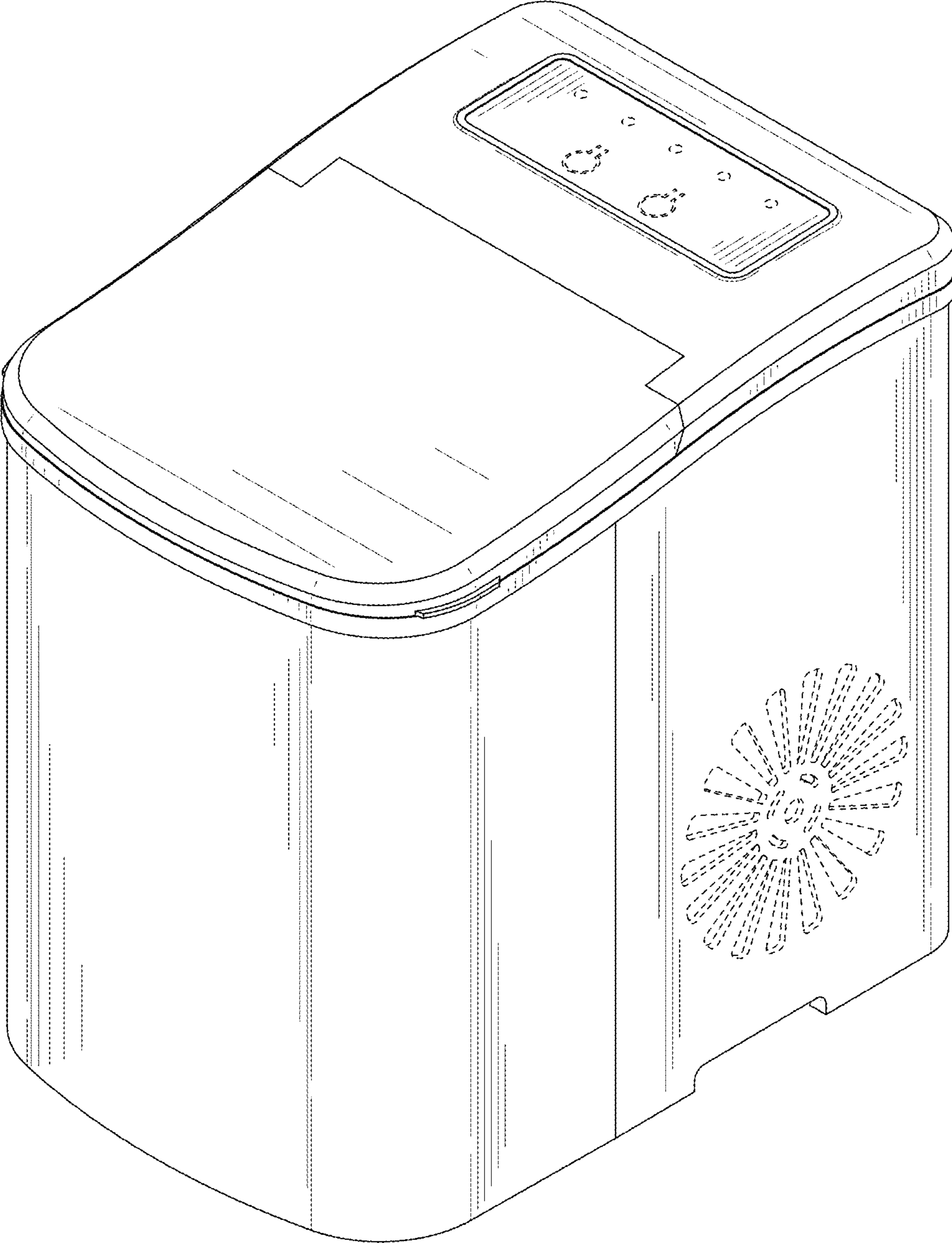

FIG. 1

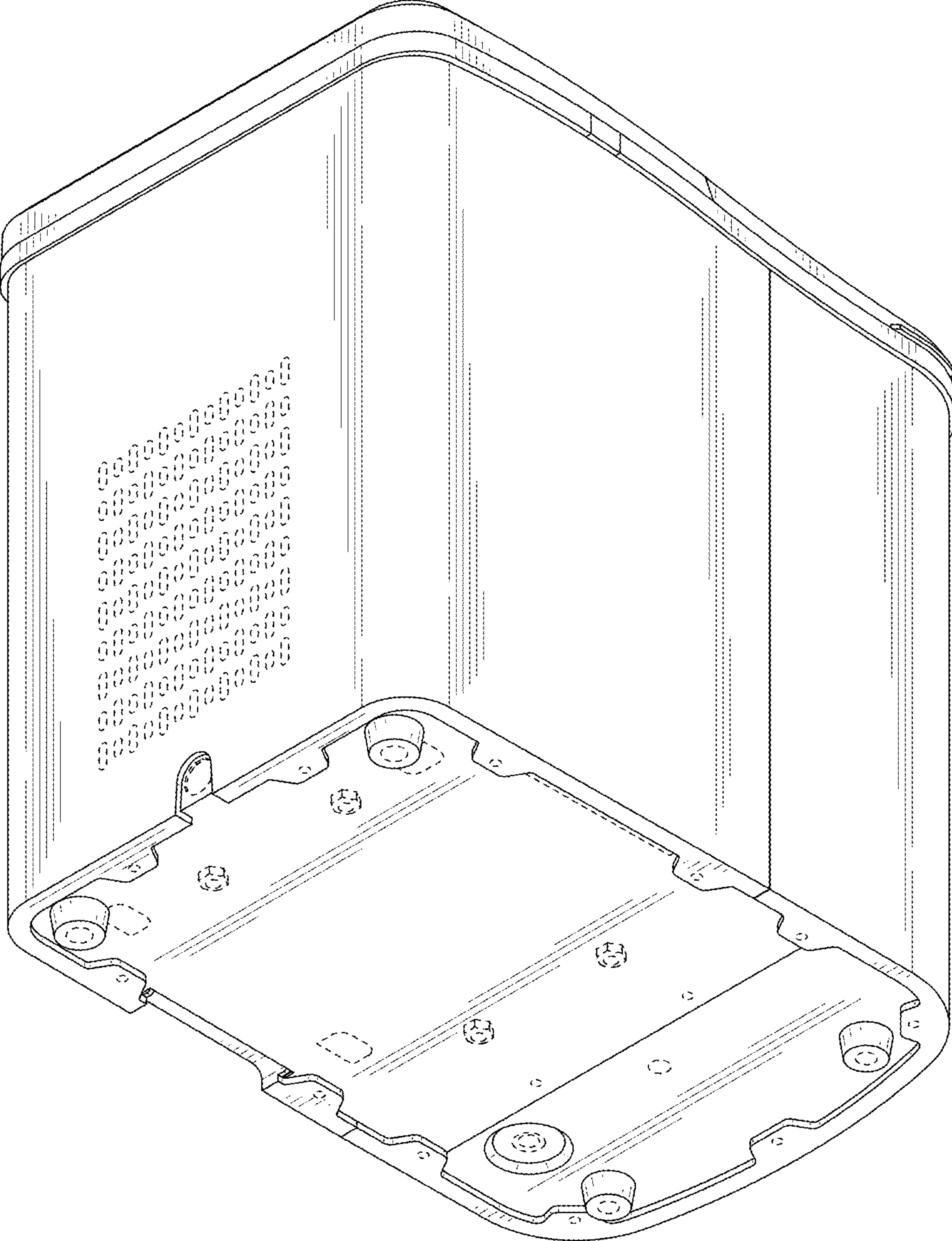

FIG. 2

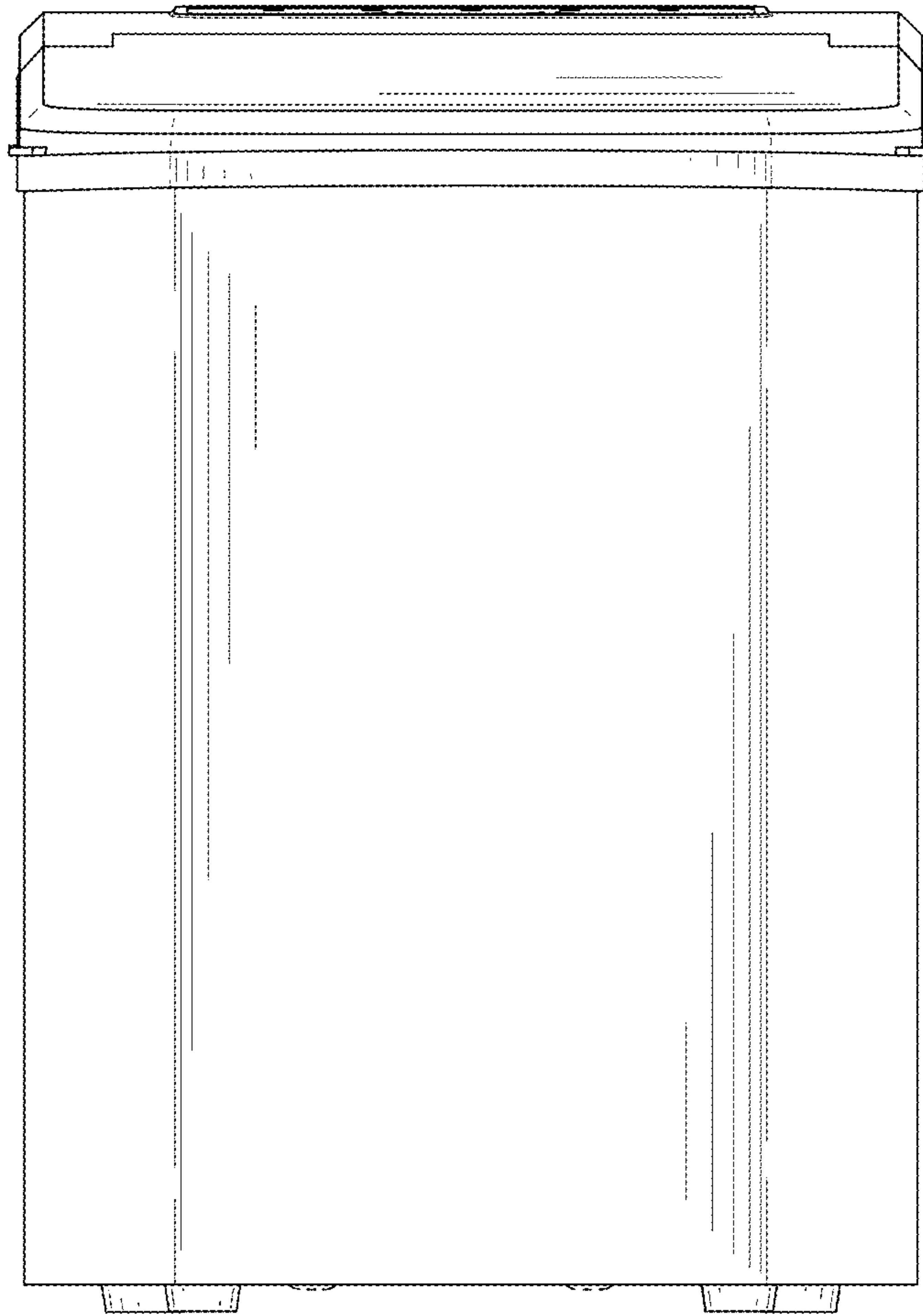

FIG. 3

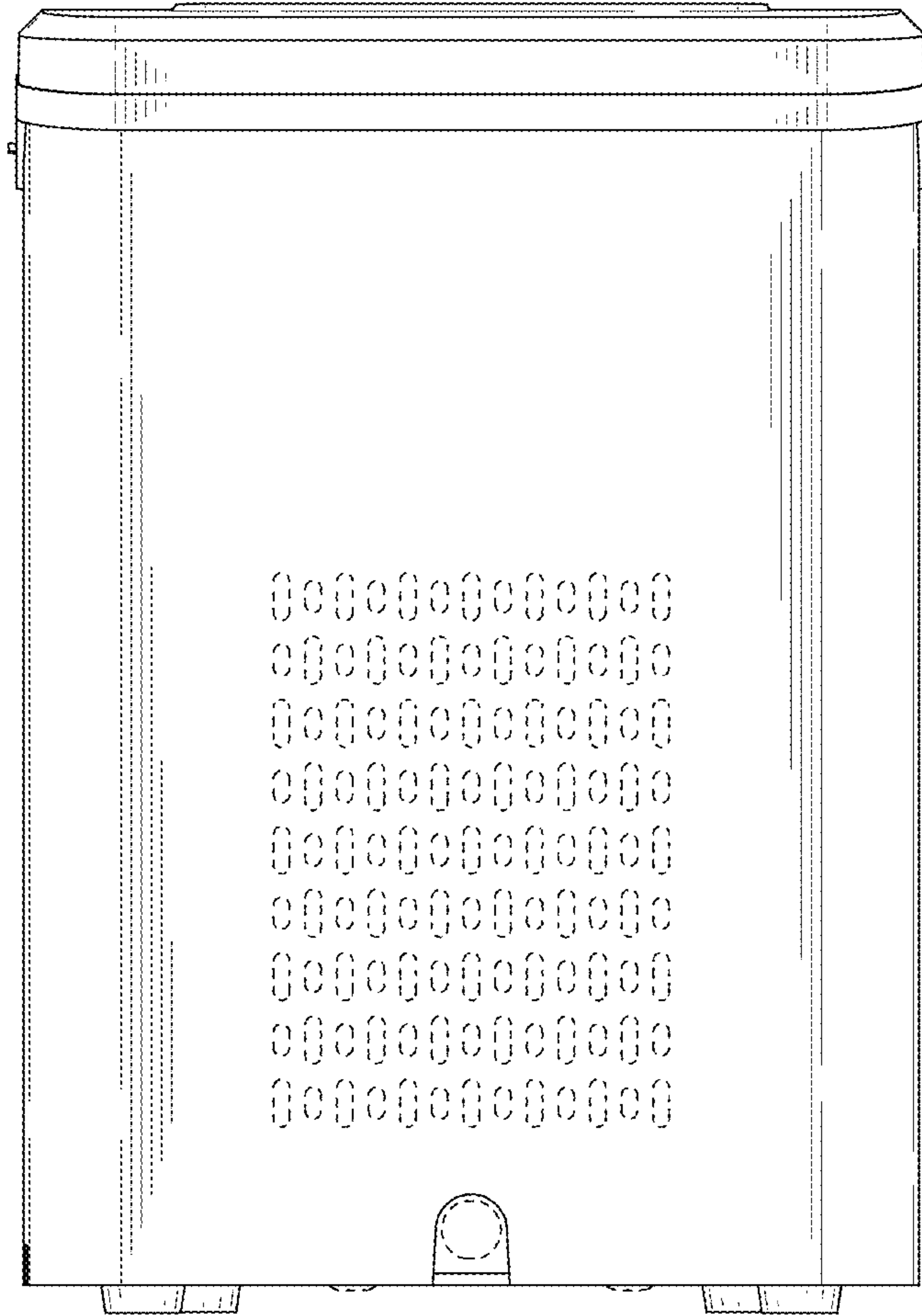

FIG. 4

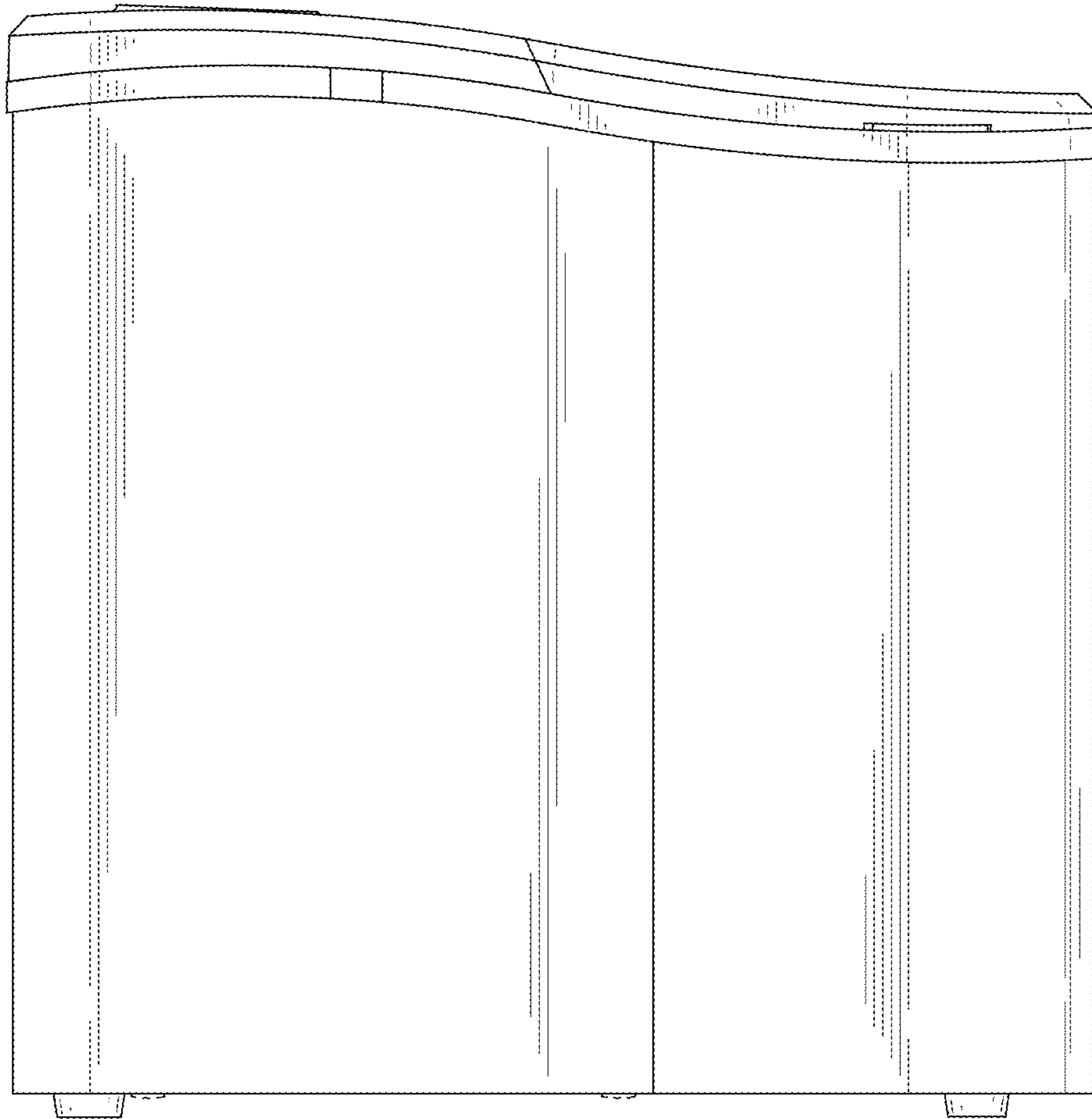

FIG. 5

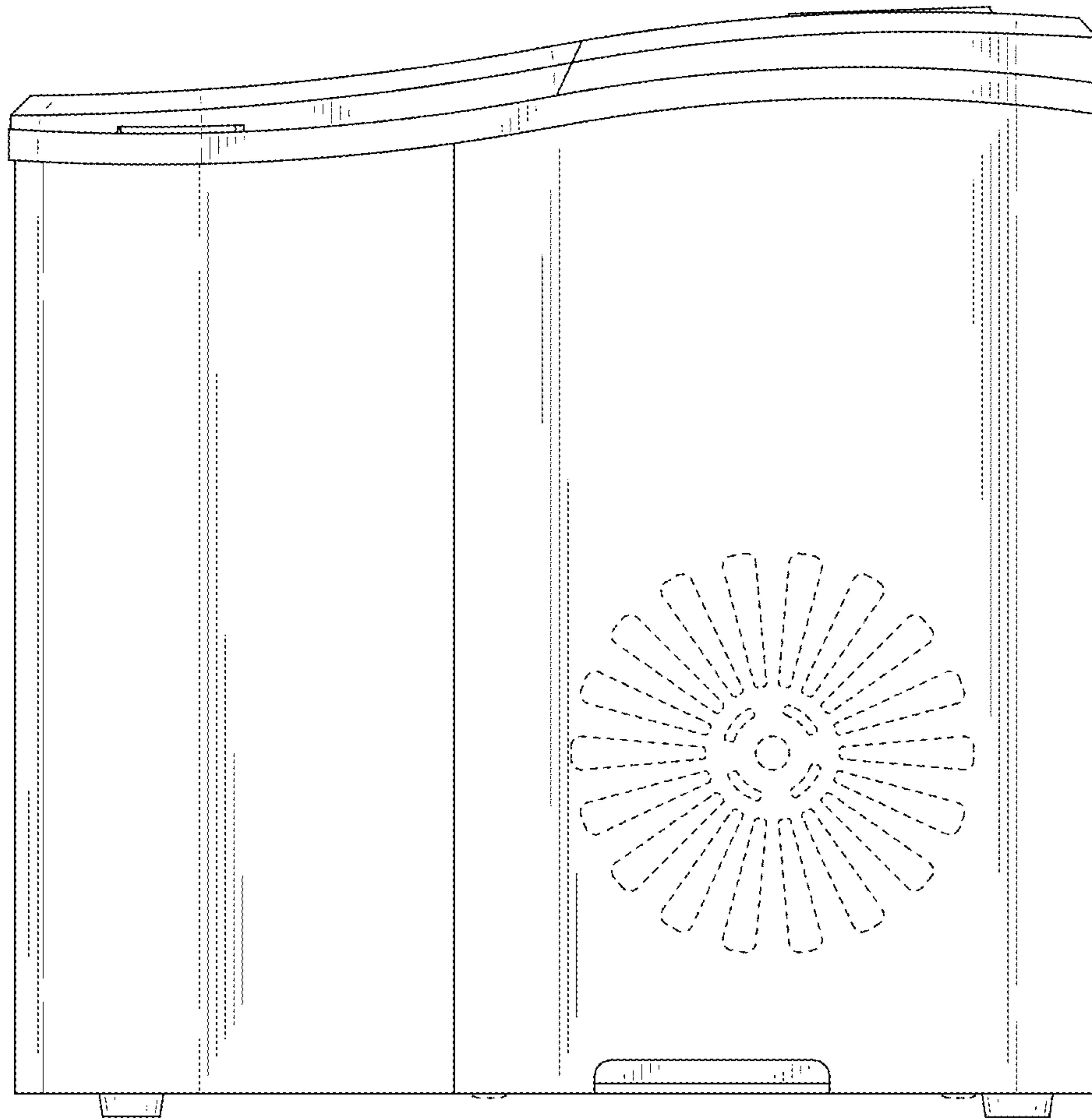

FIG. 6

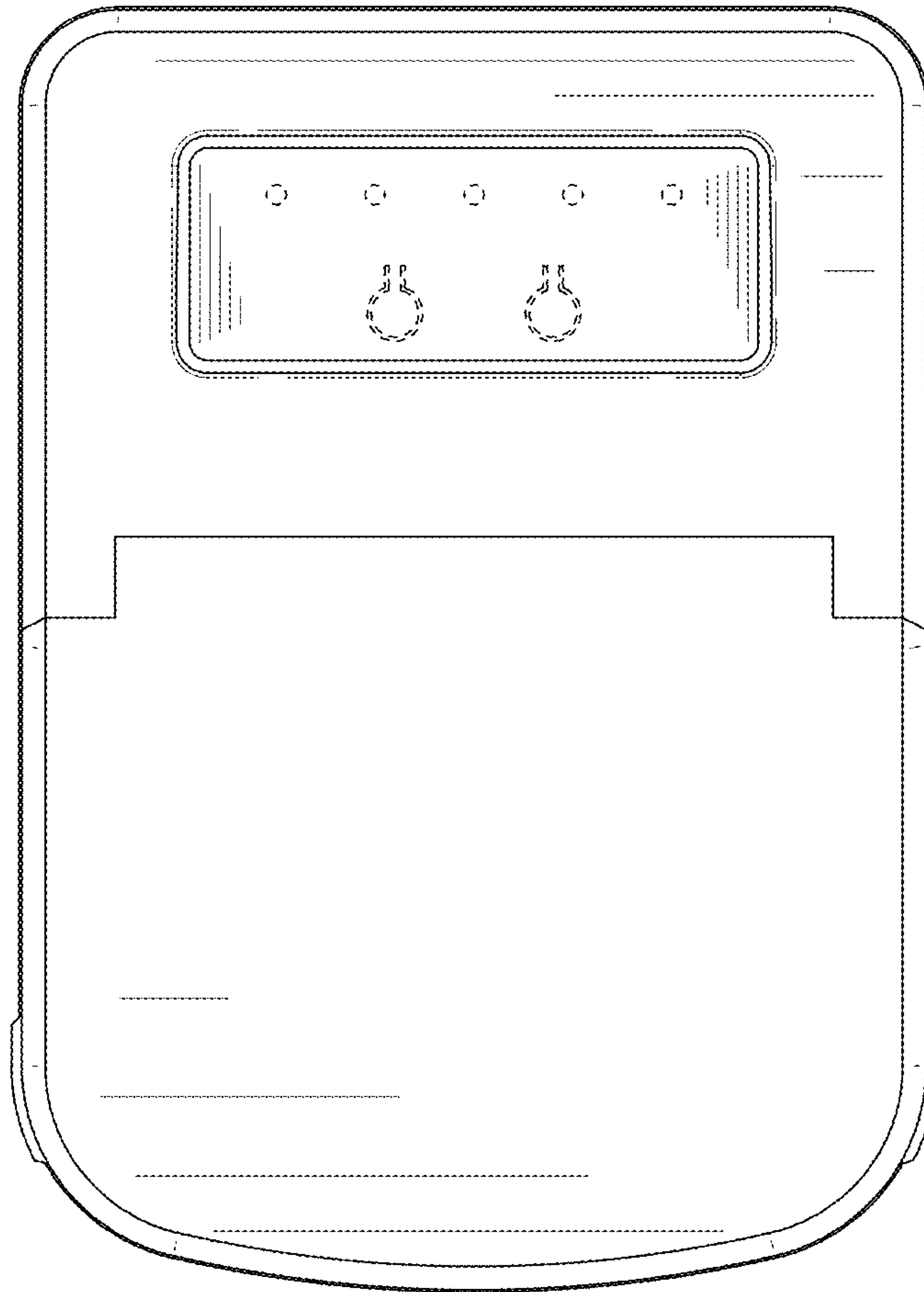

FIG. 7

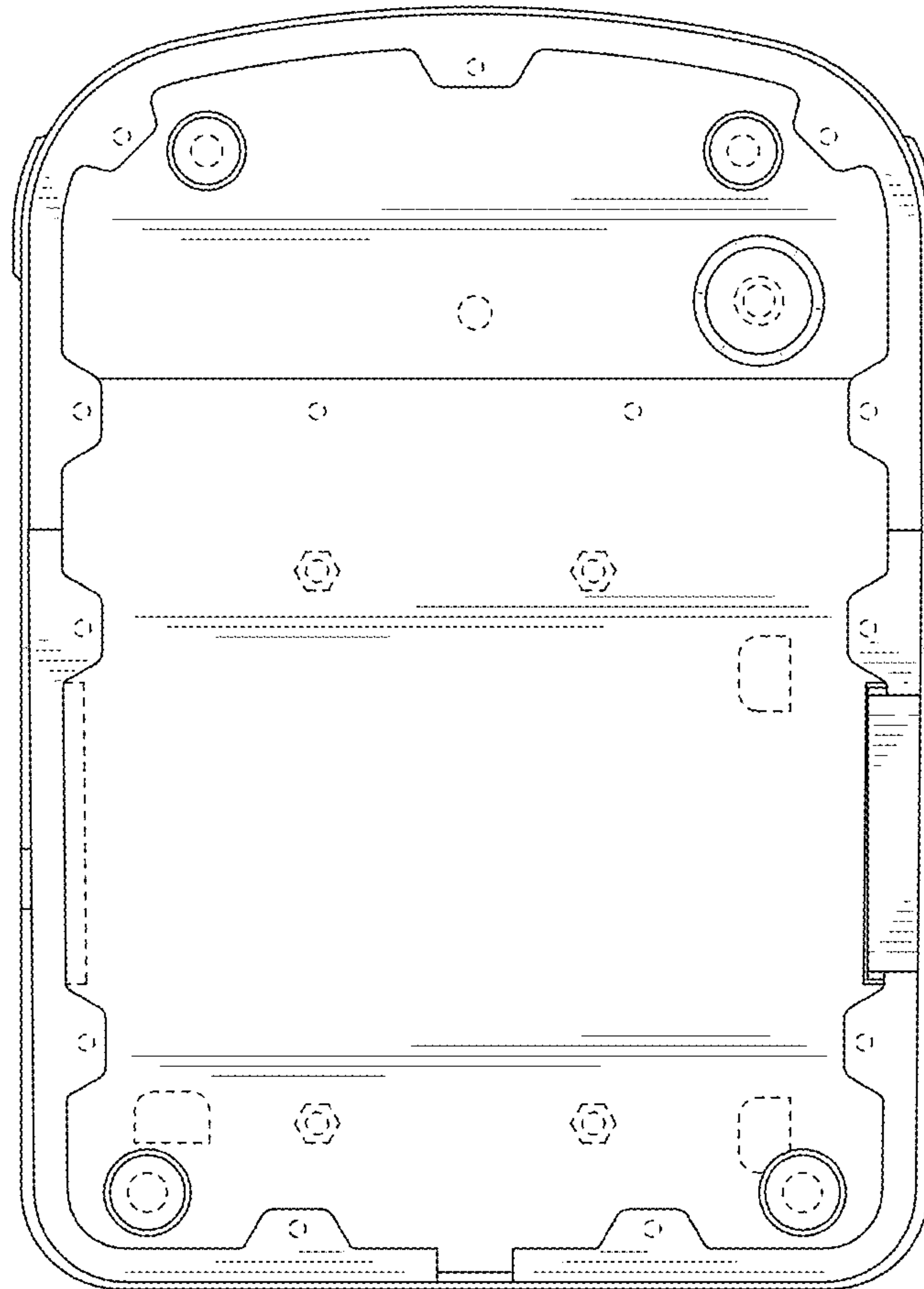

FIG. 8