



US00D983203S

(12) **United States Design Patent** (10) **Patent No.:** **US D983,203 S**
Sieckowski et al. (45) **Date of Patent:** **** Apr. 11, 2023**

(54) **DATA CAPTURE DEVICE**

(71) Applicant: **ZEBRA TECHNOLOGIES CORPORATION**, Lincolnshire, IL (US)

(72) Inventors: **Steven D. Sieckowski**, Port Jefferson, NY (US); **Edward Anthony Hackett**, Surbiton (GB); **Liao-Hsun Chen**, Keelung (TW)

(73) Assignee: **Zebra Technologies Corporation**, Lincolnshire, IL (US)

(**) Term: **15 Years**

(21) Appl. No.: **29/840,312**

(22) Filed: **May 27, 2022**

Related U.S. Application Data

(63) Continuation of application No. 29/766,087, filed on Jan. 13, 2021, now Pat. No. Des. 956,755, which is a (Continued)

(51) **LOC (14) Cl.** **14-02**

(52) **U.S. Cl.**
USPC **D14/420**

(58) **Field of Classification Search**
USPC D14/420, 426-430, 453; 235/462.01, 235/462.11, 462.43, 462.45, 462.49, 235/472.01, 385, 454, 435, 439-441, 375, 235/444, 456, 459, 462.14, 462.17, 462.2, 235/462.21, 490, 494, 476, 462.22, 235/462.32, 462.35; 382/313, 321, 318; 358/473; 250/215, 216, 566, 239, 221; D26/37-50, 24; 362/157, 158, 171-174, 362/183-208; 396/427; D24/158; D10/46; D16/219, 208, 202
CPC .. G06K 7/1417; G06K 7/1404; G06K 7/1408; G06K 7/1413; G06K 7/1495; G06K 7/10722; G06K 7/10752; G06K 7/10732; G06K 7/10544; G06K 7/10574; G06K

7/10742; G06K 7/10831; G06K 7/10821; G06K 7/10584; G06K 7/10613; G06K 7/10881; G06K 7/109; G06K 7/10693; G06K 7/10871; G06K 7/1096; G06K 7/10; G06K 7/10564; G06K 7/10594; G06K 7/10603; G06K 7/10663; G06K 7/10673; G06K 7/10702; G06K 7/10792; G06K 7/10633; G06K 7/10653; G06K 7/10891; G06K 7/14; G06K 7/1443; G06K 7/10801; G06K 7/10811; G06K 7/10851; G06K

(Continued)

(56) **References Cited**

U.S. PATENT DOCUMENTS

D359,483 S * 6/1995 Saunders D14/420
5,612,530 A * 3/1997 Sanders G06K 7/10881
235/462.48

(Continued)

Primary Examiner — Susan Moon Lee

(57) **CLAIM**

We claim the ornamental design for a data capture device, as shown and described.

DESCRIPTION

FIG. 1 is a front perspective view of an example data capture device;
FIG. 2 is a rear perspective view thereof;
FIG. 3 is a front view thereof;
FIG. 4 is a rear view thereof;
FIG. 5 is a first side view thereof;
FIG. 6 is a second side view thereof;
FIG. 7 is a top view thereof; and,
FIG. 8 is a bottom view thereof.
Broken lines of a particular embodiment are for purposes of illustrating environment and form no part of the claimed design.

1 Claim, 8 Drawing Sheets

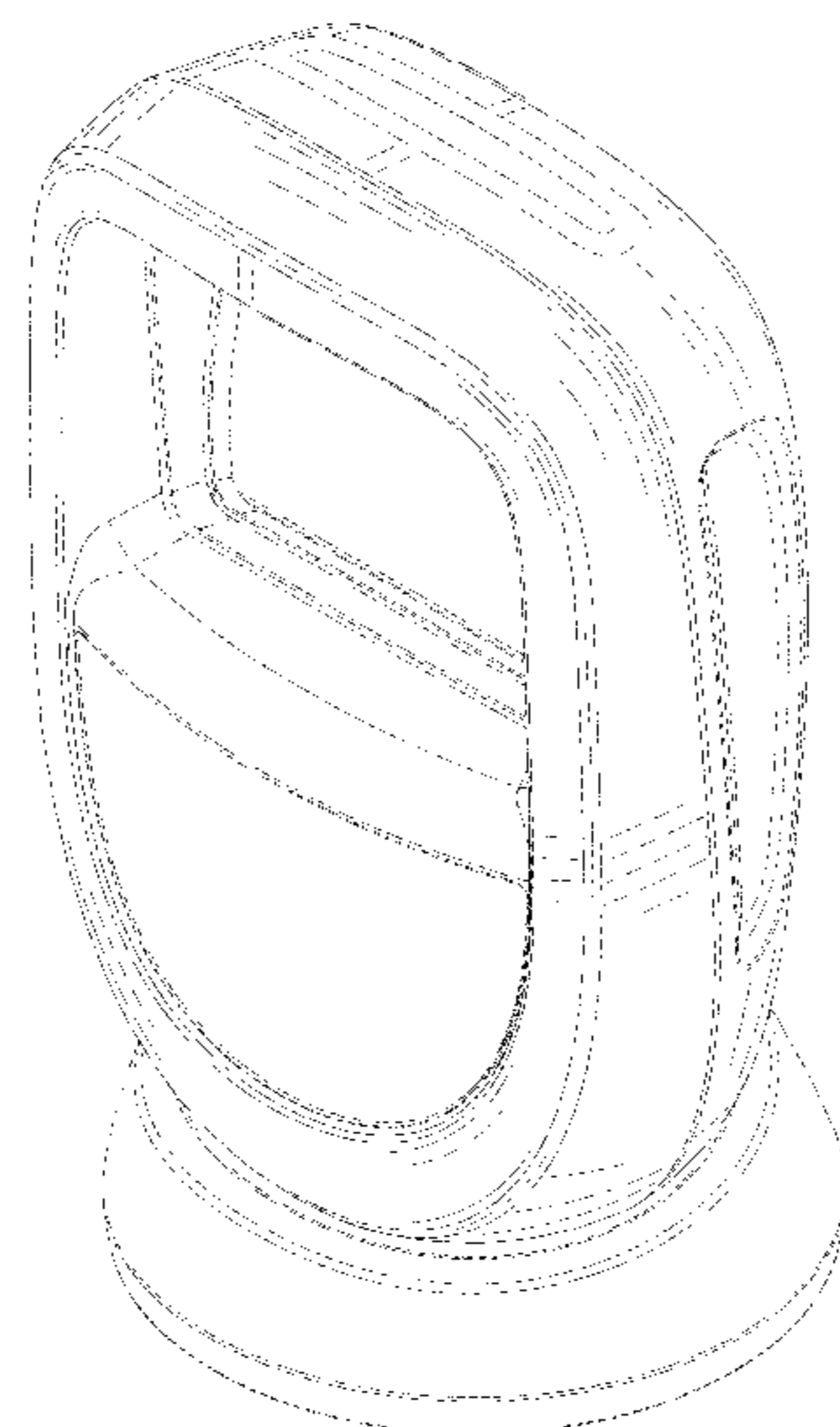

Related U.S. Application Data

continuation of application No. 29/676,550, filed on Jan. 11, 2019, now Pat. No. Des. 910,021.

(58) **Field of Classification Search**

CPC 7/10861; G06K 2207/1011; G06K 2207/1012; G06K 2207/1013; G06K 2207/1016; G06K 2207/1017; G06K 2207/1018; G06K 2207/10534; G06K 17/0022; G06K 7/04; G06K 7/1447; G06K 7/10623; G06K 7/10683; A47F 9/046; A47F 9/047; G07G 1/0045; G04N 5/23238; G04N 5/2252; G04N 5/2251; G03B 17/02; B25H 5/00; B66F 7/28; G02B 26/10; G02B 26/106; G02B 1/08; G02B 19/0095; G02B 19/0028; G02B 19/0076; G07F 11/002; G07F 11/02; G06Q 20/343; G06Q 10/08; G06F 2203/0331; G01V 8/10; G01D 11/245; G01D 11/28

See application file for complete search history.

(56) **References Cited**

U.S. PATENT DOCUMENTS

5,861,615 A * 1/1999 Bridgelall G06K 7/10584
235/472.01
D454,879 S * 3/2002 Lin D14/421
D494,179 S * 8/2004 Berentzen D14/426
8,186,592 B2 * 5/2012 Fletcher G07G 1/0045
235/462.01
8,342,409 B2 * 1/2013 Handshaw G06K 7/10792
235/462.31
8,381,979 B2 * 2/2013 Franz G06K 7/0004
235/462.43

8,389,945 B1 * 3/2013 Vinogradov G06K 7/10792
250/371
8,408,464 B2 * 4/2013 Zhu H04N 5/2353
235/455
D735,197 S * 7/2015 Fukuba D14/420
10,452,882 B2 * 10/2019 Wang G06K 7/10831
10,803,268 B2 * 10/2020 Klicpera H02J 7/025
10,817,690 B2 * 10/2020 Handshaw G06K 7/1098
D910,021 S * 2/2021 Sieckowski D14/420
11,062,103 B2 * 7/2021 Zhao G06K 7/109
11,308,292 B2 * 4/2022 Handshaw G06K 7/1408
D956,755 S * 7/2022 Sieckowski D14/420
2006/0081712 A1 * 4/2006 Rudeen G06K 7/14
235/462.08
2008/0290173 A1 * 11/2008 Kotlarsky G06K 7/10752
235/462.45
2008/0302873 A1 * 12/2008 Kotlarsky G06K 7/10732
235/462.15
2012/0049052 A1 * 3/2012 Handshaw G06K 7/10831
250/239
2012/0085824 A1 * 4/2012 Handshaw G06K 7/10792
235/462.31
2012/0111942 A1 * 5/2012 Liu G06K 7/10722
235/472.01
2012/0145788 A1 * 6/2012 Horn G06K 7/10821
235/462.07
2012/0193422 A1 * 8/2012 Franz G06K 7/10297
235/462.13
2012/0203647 A1 * 8/2012 Smith G08B 13/246
705/23
2014/0097337 A1 * 4/2014 Handshaw G06K 7/10752
250/271
2020/0160013 A1 * 5/2020 Klicpera H02J 50/10
2020/0226330 A1 * 7/2020 Handshaw G06K 7/04
2020/0380218 A1 * 12/2020 Handshaw G06K 7/10722
2020/0380219 A1 * 12/2020 Zhao G06K 7/10722
2021/0042479 A1 * 2/2021 Handshaw F16M 11/10
2021/0064830 A1 * 3/2021 Handshaw G06K 7/1443

* cited by examiner

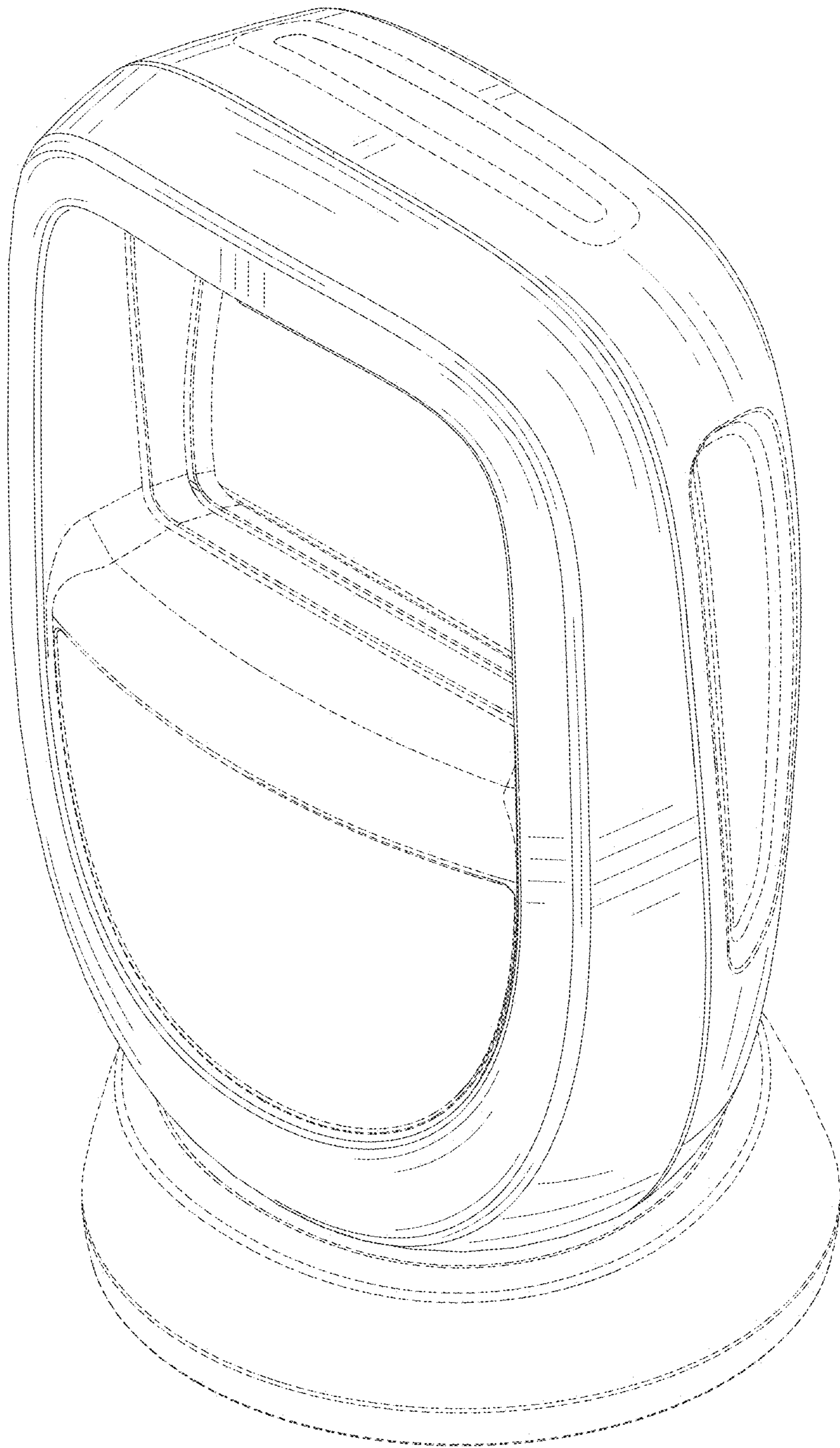

FIG. 1

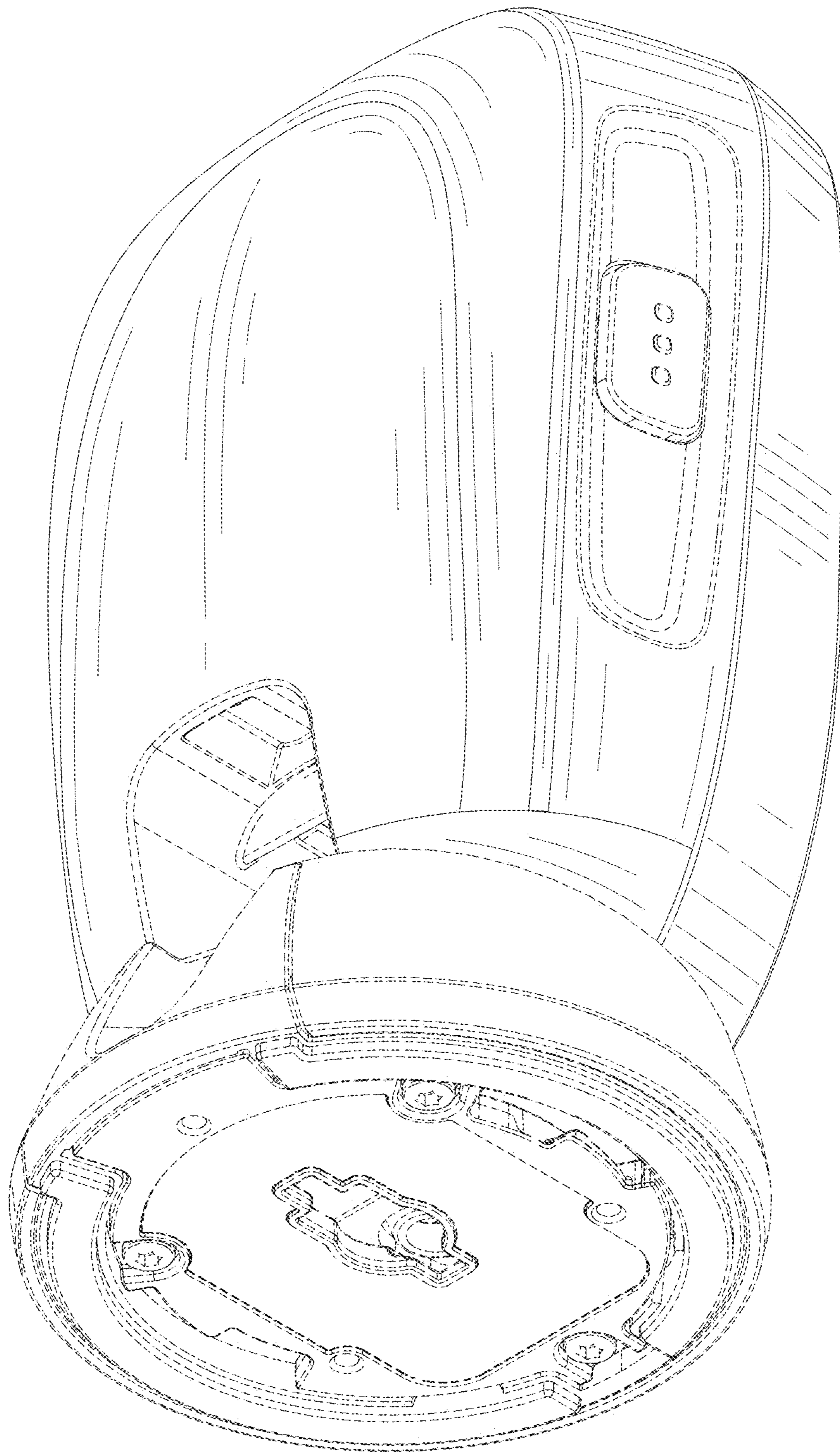

FIG. 2

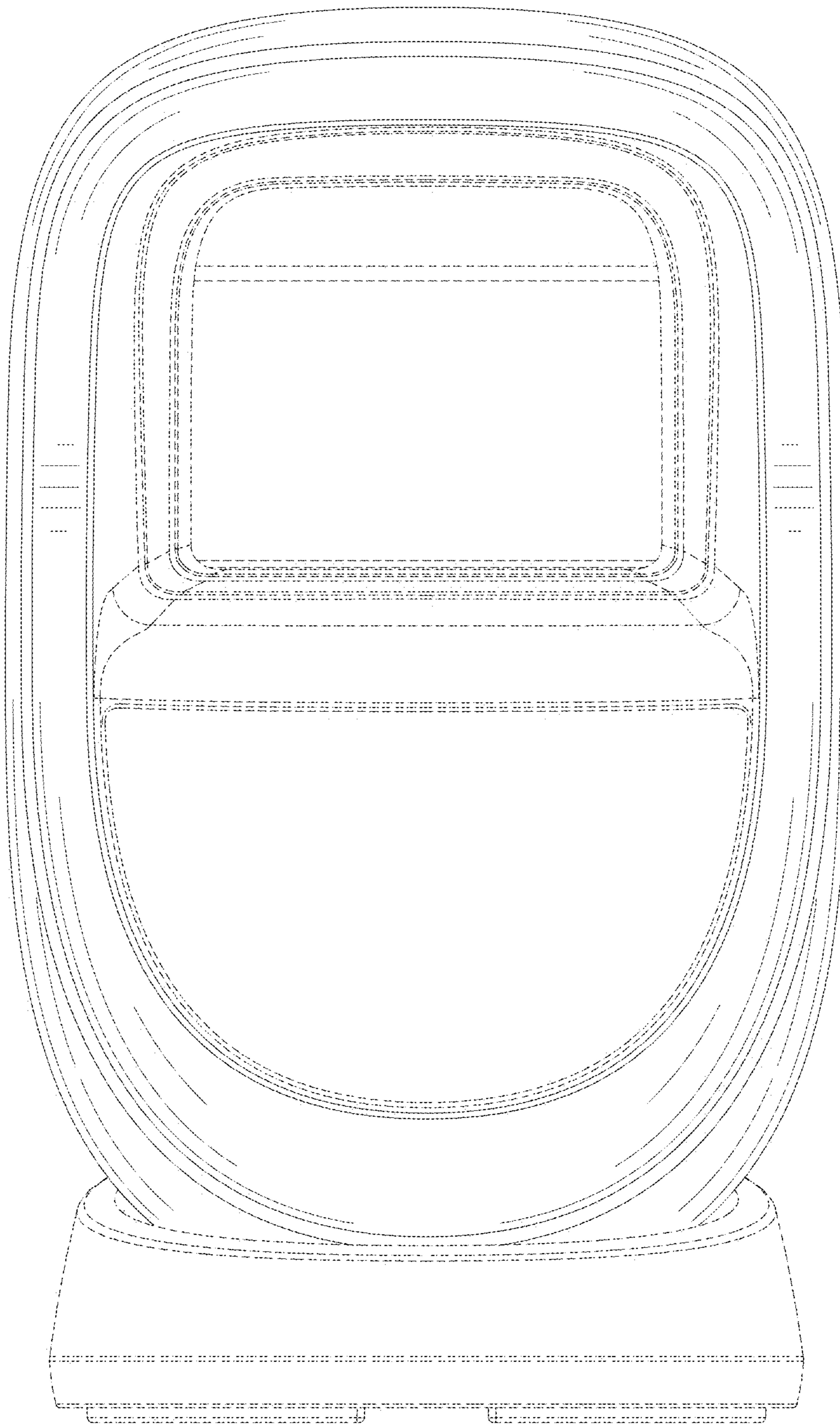

FIG. 3

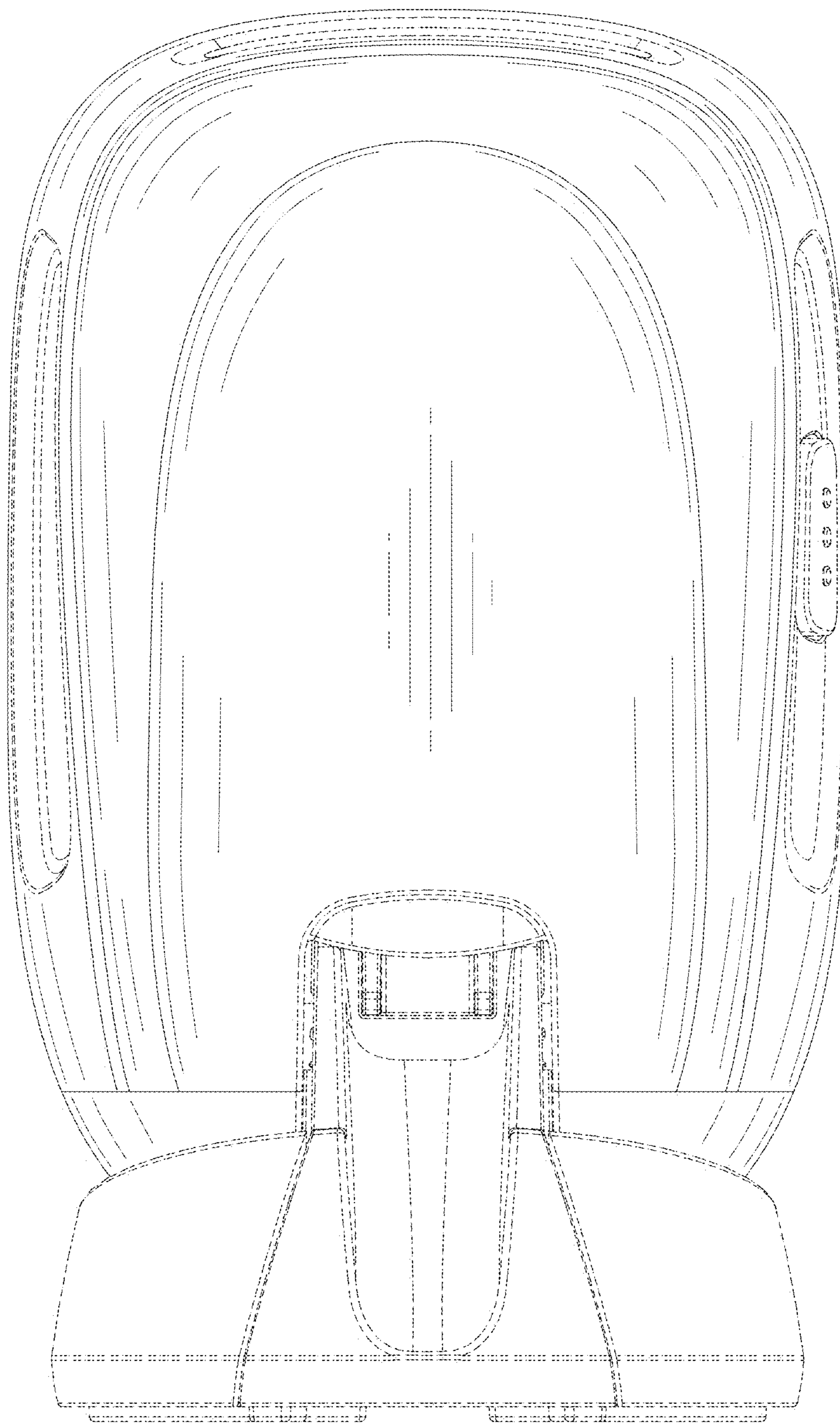

FIG. 4

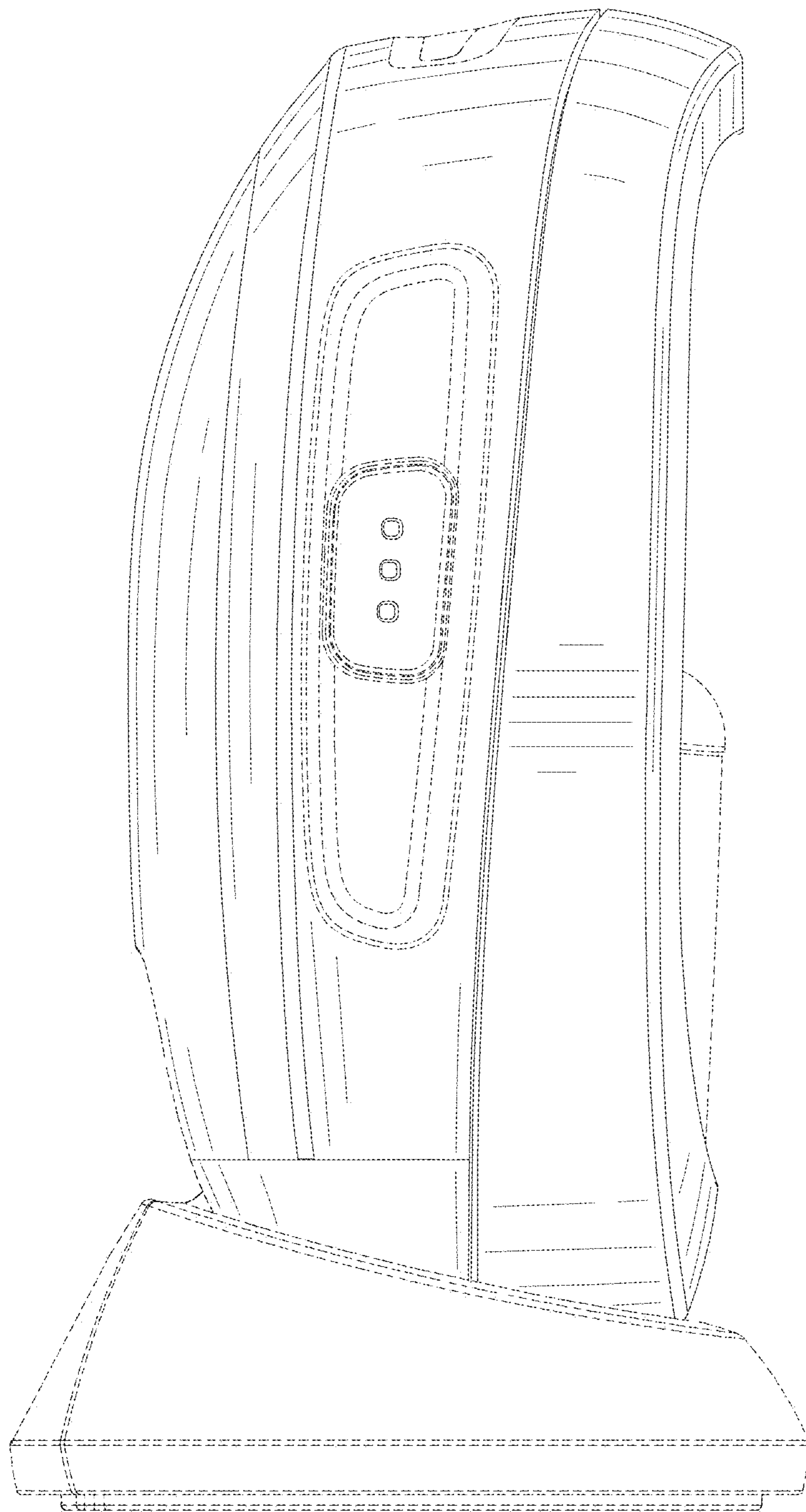

FIG. 5

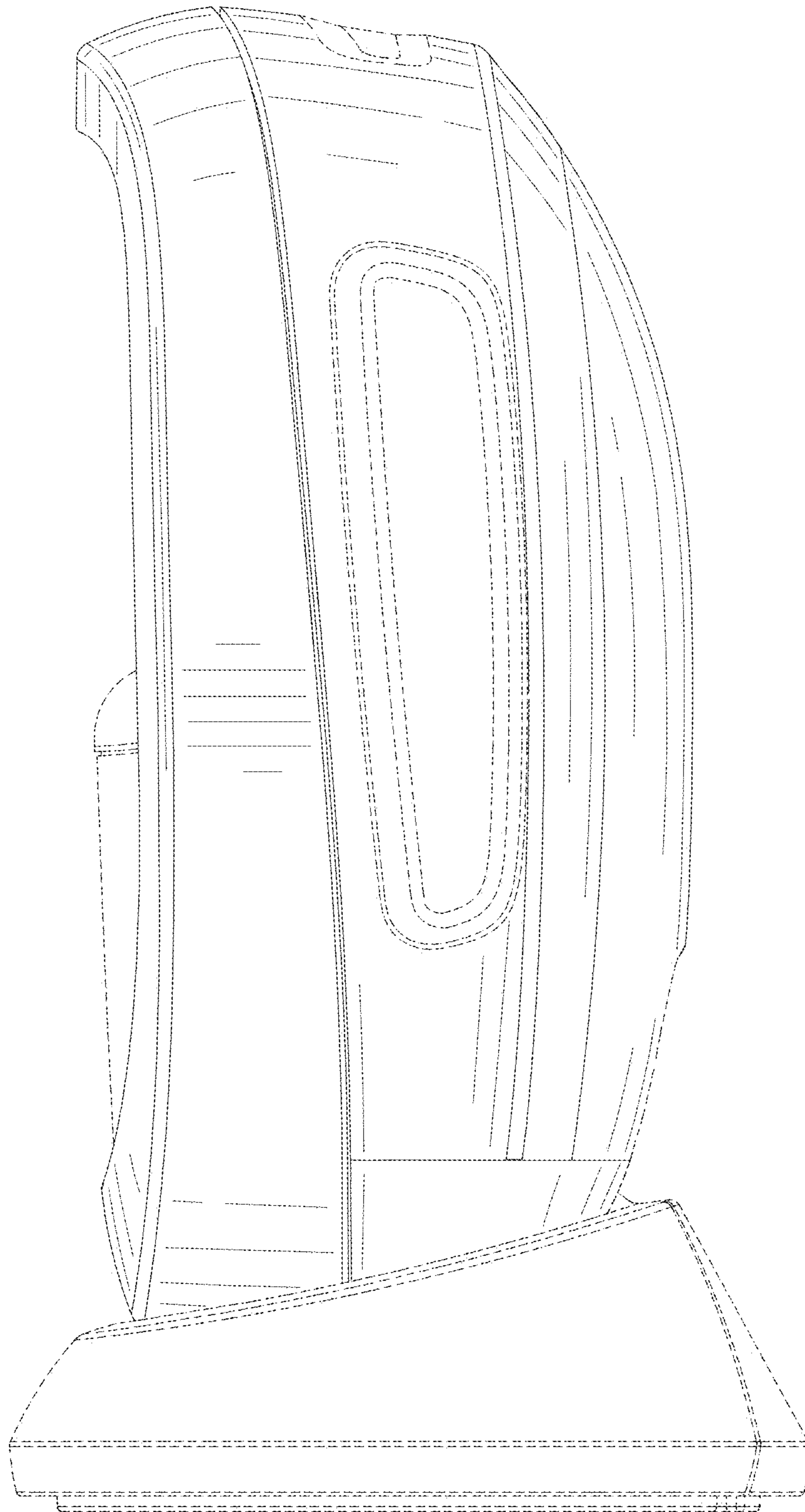

FIG. 6

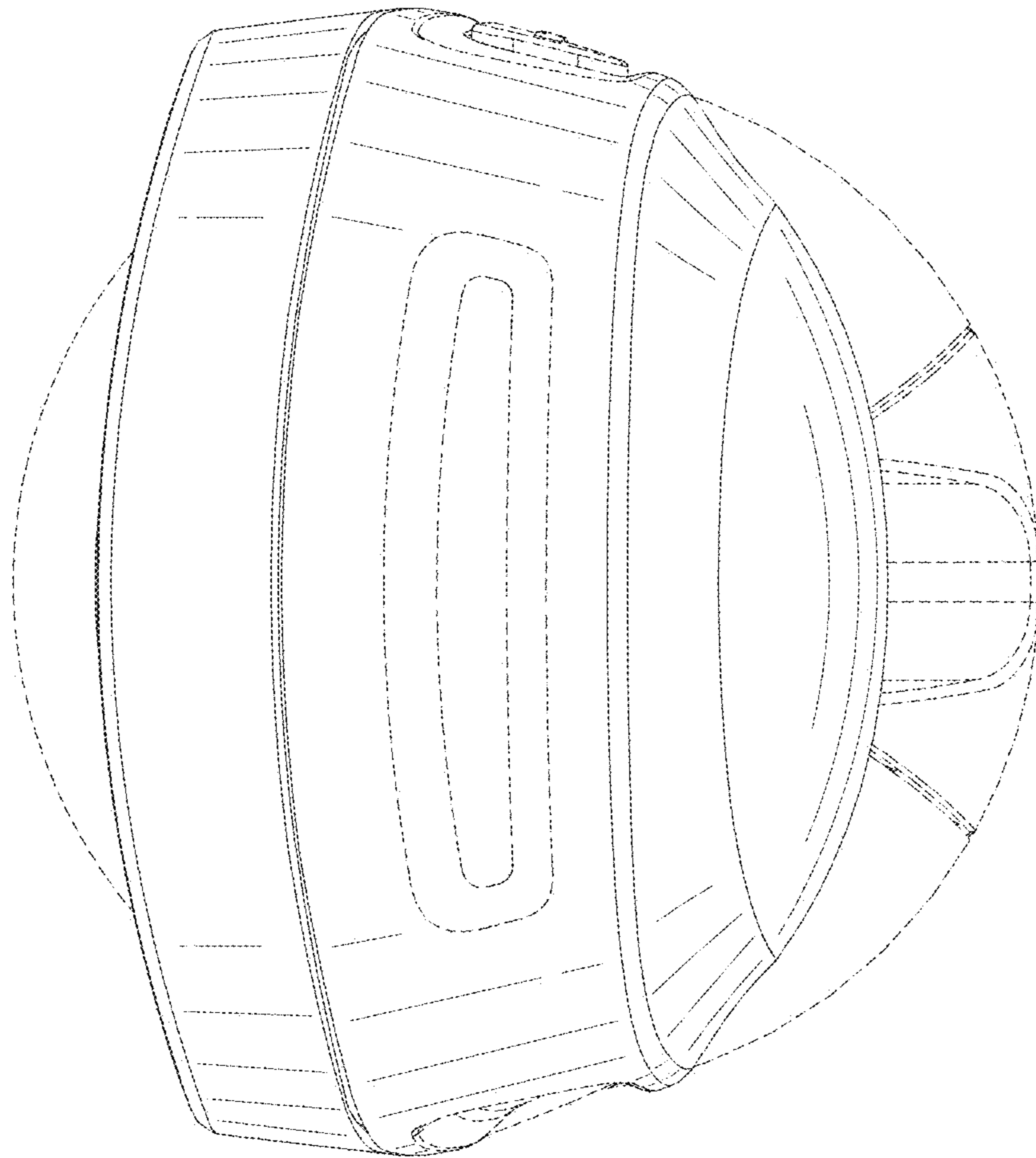

FIG. 7

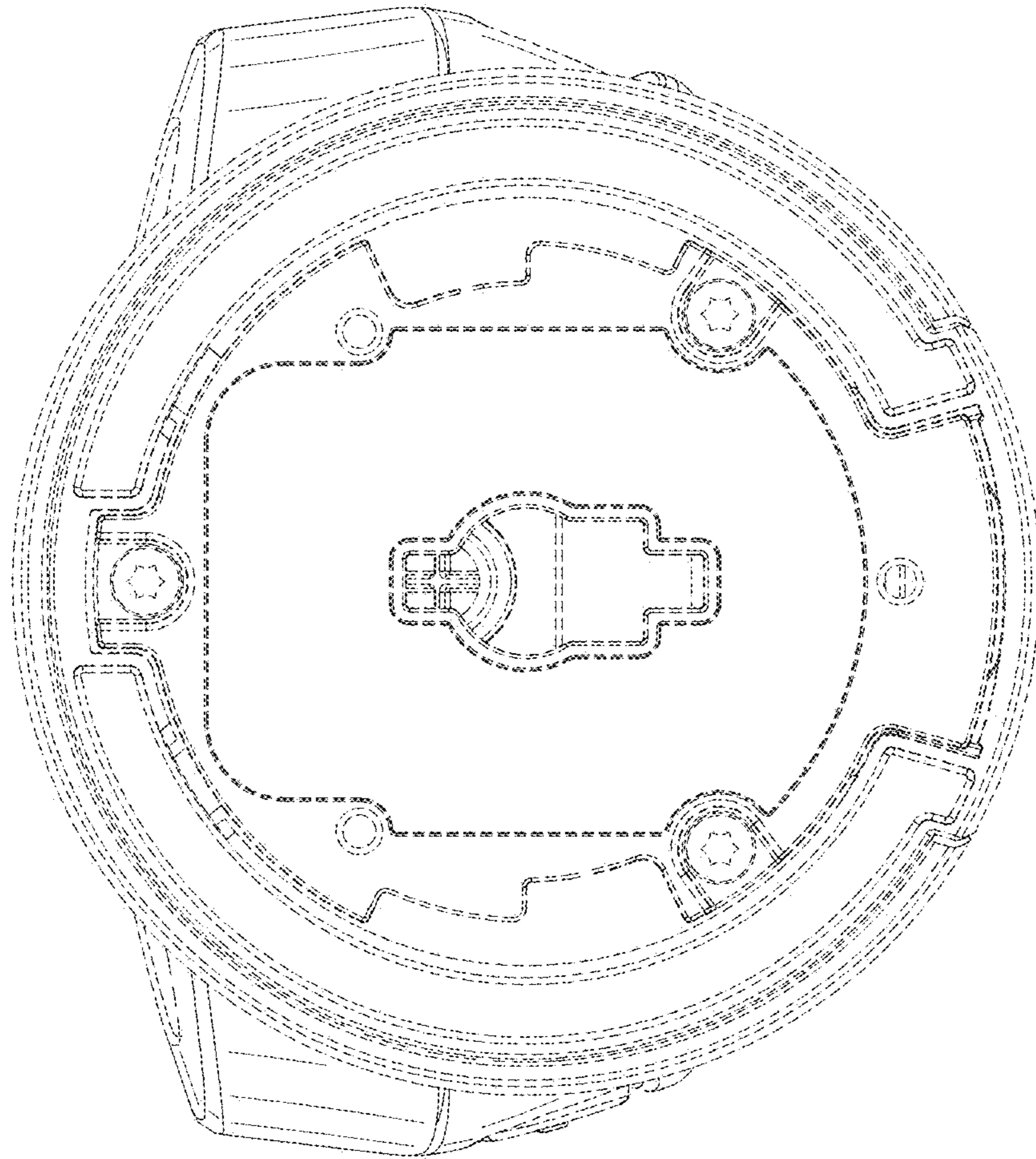

FIG. 8