



US00D983202S

(12) **United States Design Patent**  
**Dubreucq et al.**

(10) **Patent No.:** **US D983,202 S**  
(45) **Date of Patent:** **\*\* Apr. 11, 2023**

(54) **COMPUTER MOUSE**

(71) Applicant: **Logitech Europe S.A.**, Lausanne (CH)

(72) Inventors: **Maxime Dubreucq**, San Francisco, CA (US); **Tania Alvarez Moreno**, Miami, FL (US); **Kelly Kim**, Emeryville, CA (US); **Jules Moretti**, Newark, CA (US); **Mark Starrett**, Fremont, CA (US)

(73) Assignee: **Logitech Europe S.A.**, Lausanne (CH)

(\*\*) Term: **15 Years**

(21) Appl. No.: **29/807,152**

(22) Filed: **Sep. 9, 2021**

(51) **LOC (14) Cl.** ..... **14-03**

(52) **U.S. Cl.**  
USPC ..... **D14/409; D4/402**

(58) **Field of Classification Search**  
USPC ..... D14/402–411, 356, 388, 389, 383–385, D14/417, 426; 345/156–167; 463/36–38; 358/471, 473; 273/148 B  
CPC ..... G06F 3/03543; G06F 2203/0333; G06F 3/039; G06F 3/038; G06F 2203/0384  
See application file for complete search history.

(56) **References Cited**

**U.S. PATENT DOCUMENTS**

D387,749 S *	12/1997	Diaz	.....	D14/409
D405,072 S *	2/1999	Tso	.....	D14/409
D435,555 S *	12/2000	Swansey	.....	D14/408
D459,353 S *	6/2002	Lee	.....	D14/408
D591,747 S *	5/2009	Hu	.....	D14/402
D618,684 S *	6/2010	Ng	.....	D14/402

D659,695 S *	5/2012	Chen	.....	D14/409
D688,663 S *	8/2013	Widiaman	.....	D14/402
D908,698 S *	1/2021	Chong	.....	D14/402
D908,700 S *	1/2021	Chan	.....	D14/402
D925,537 S *	7/2021	Carey	.....	D14/409
D929,403 S *	8/2021	Liu	.....	D14/402
D930,651 S *	9/2021	Cai	.....	D14/409
D954,054 S *	6/2022	Huang	.....	D14/402
D956,048 S *	6/2022	Dubreucq	.....	D14/402
D962,238 S *	8/2022	Huang	.....	D14/402
D965,595 S *	10/2022	Zhu	.....	D14/402

\* cited by examiner

*Primary Examiner* — Austin Murphy

(74) *Attorney, Agent, or Firm* — Kilpatrick Townsend & Stockton LLP

(57) **CLAIM**

The ornamental design for a computer mouse, as shown and described.

**DESCRIPTION**

FIG. 1 is a top, front perspective view of a computer mouse showing my/our new design;  
FIG. 2 is a second, top perspective view thereof;  
FIG. 3 is a top, rear perspective view thereof;  
FIG. 4 is a top plan view thereof;  
FIG. 5 is a bottom plan view thereof;  
FIG. 6 is a front elevation thereof;  
FIG. 7 is a rear elevation view thereof;  
FIG. 8 is a left side elevation view thereof; and,  
FIG. 9 is a right side elevation view thereof.  
The broken lines depict portions of the computer mouse in which the design is embodied that form no part of the claimed design.

**1 Claim, 7 Drawing Sheets**

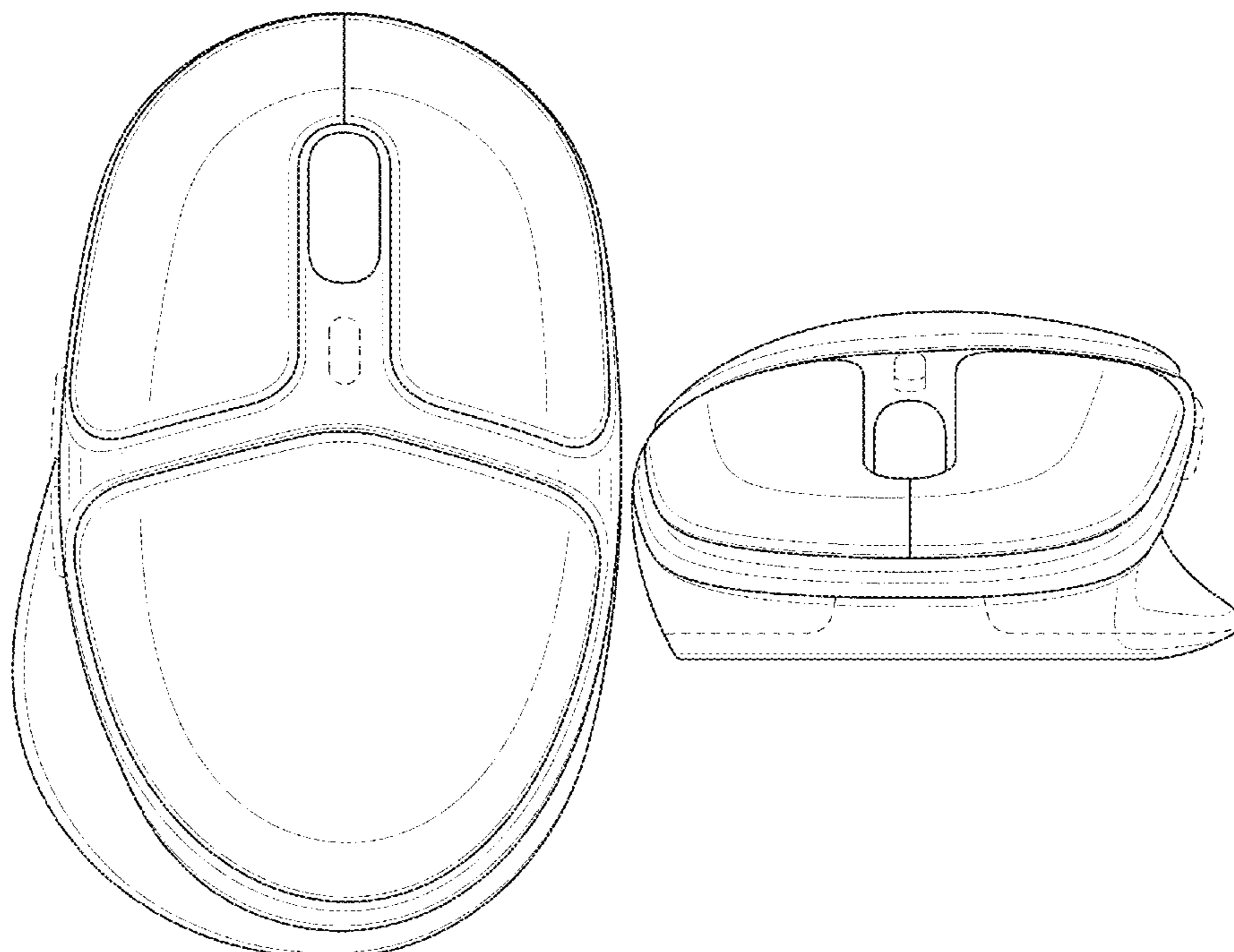

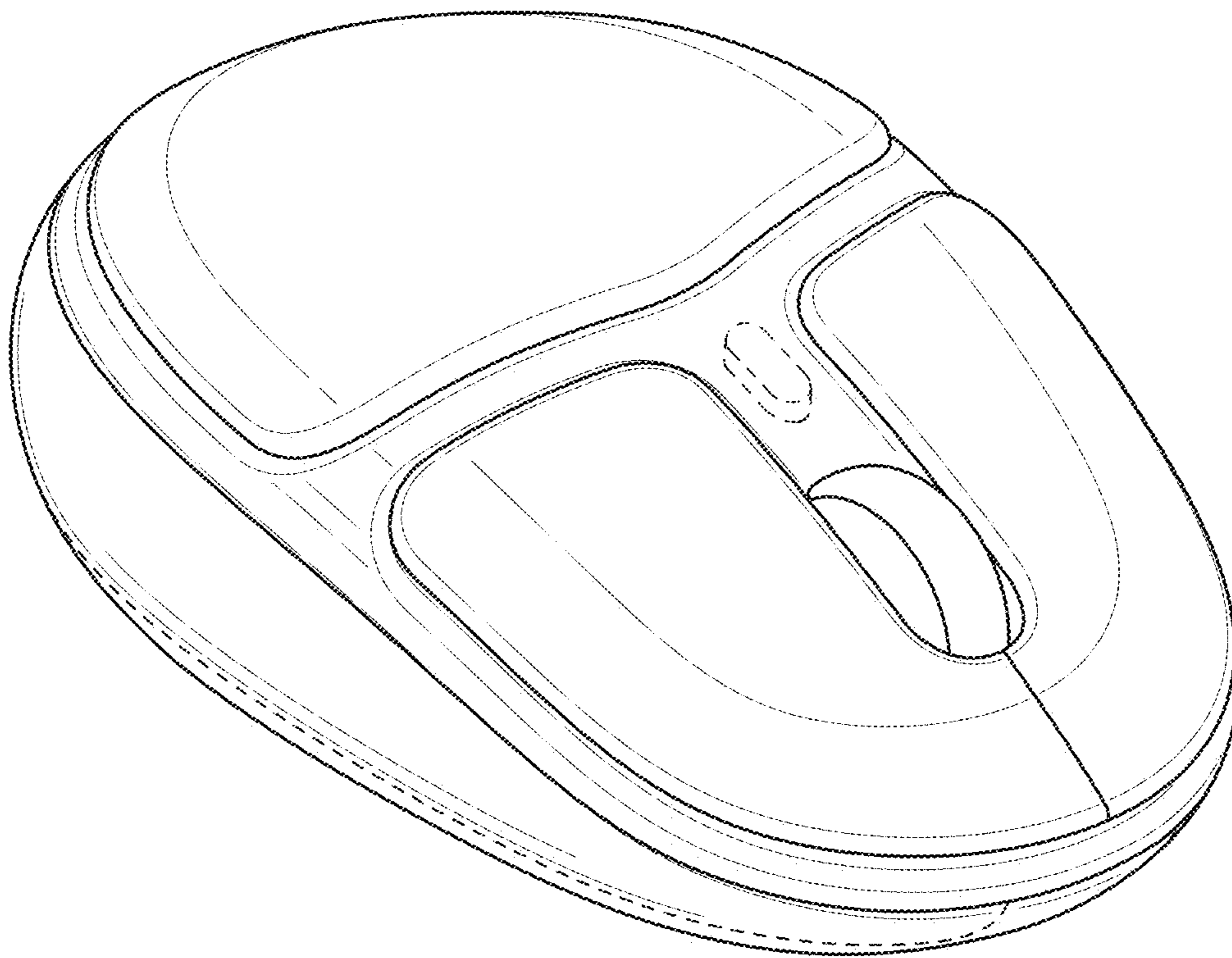

FIG. 1

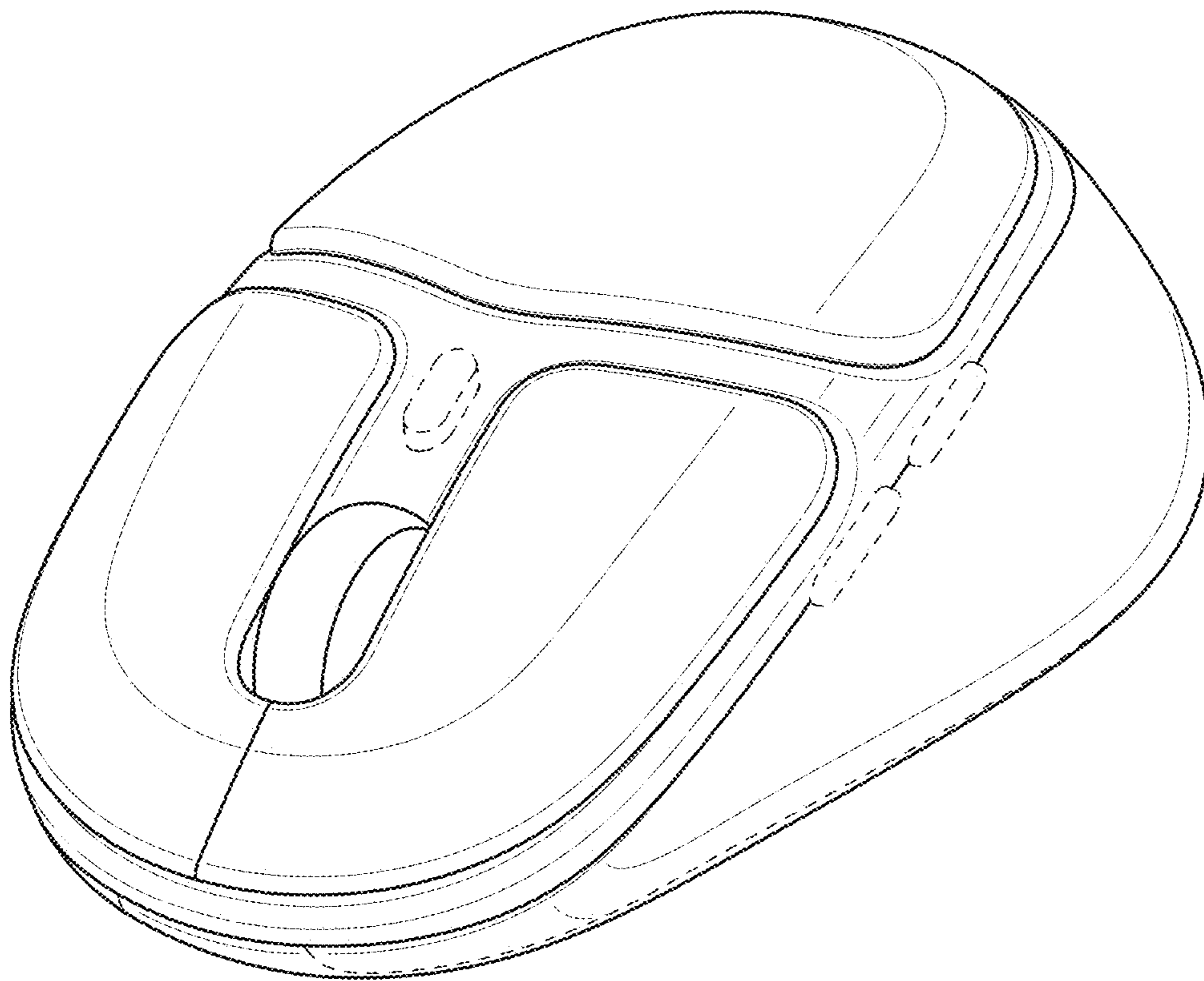

FIG. 2

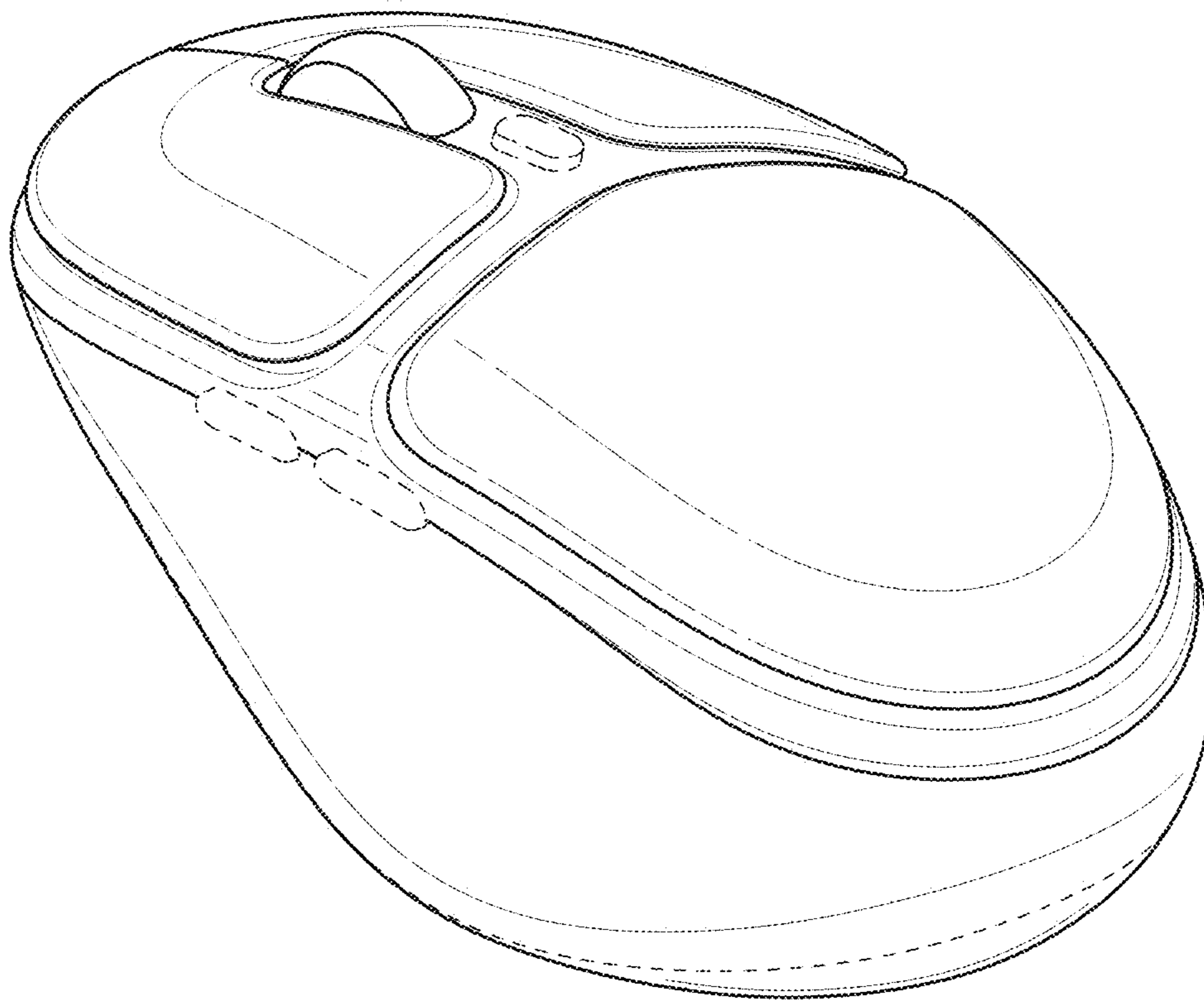

FIG. 3

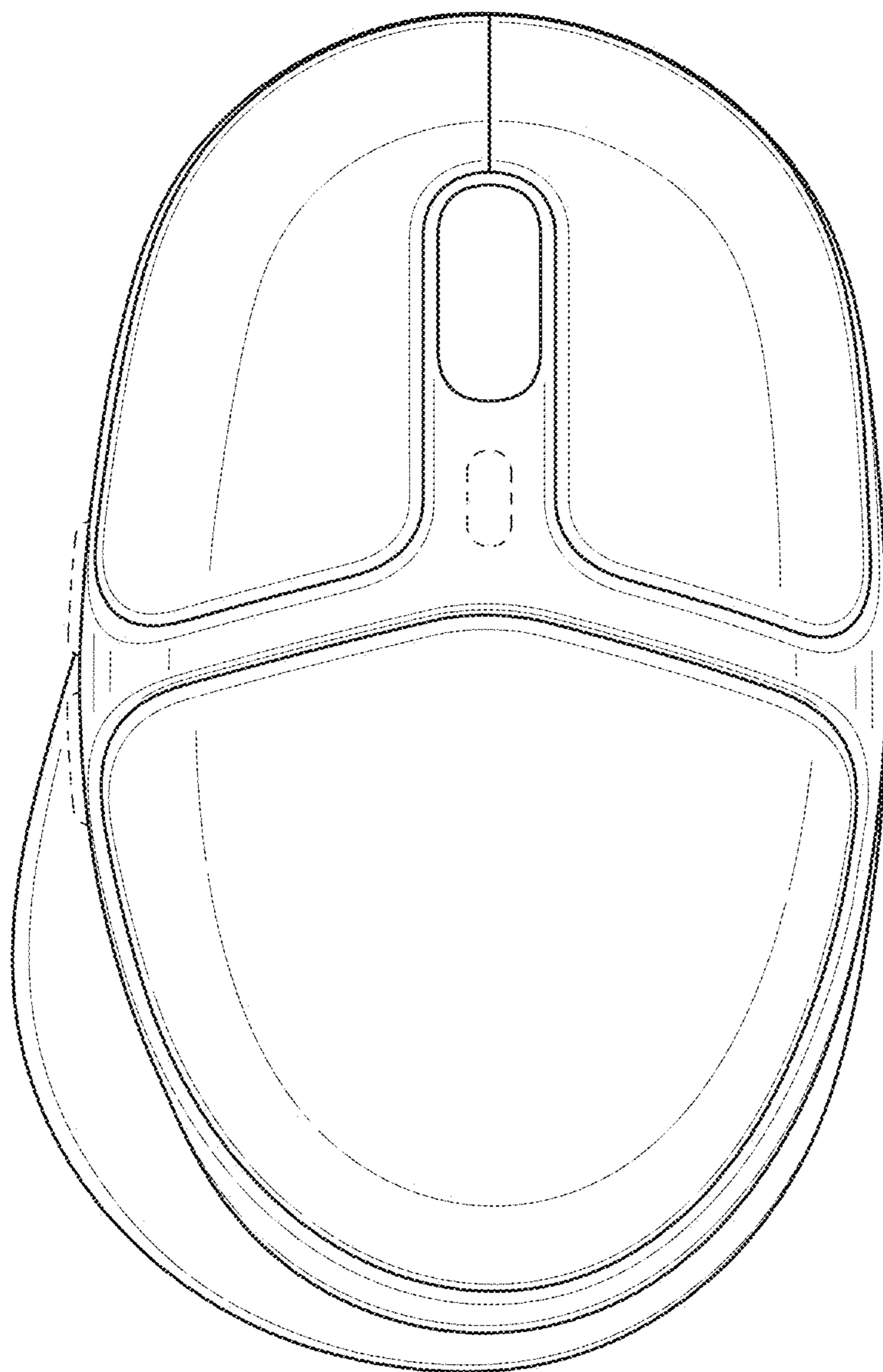

FIG. 4

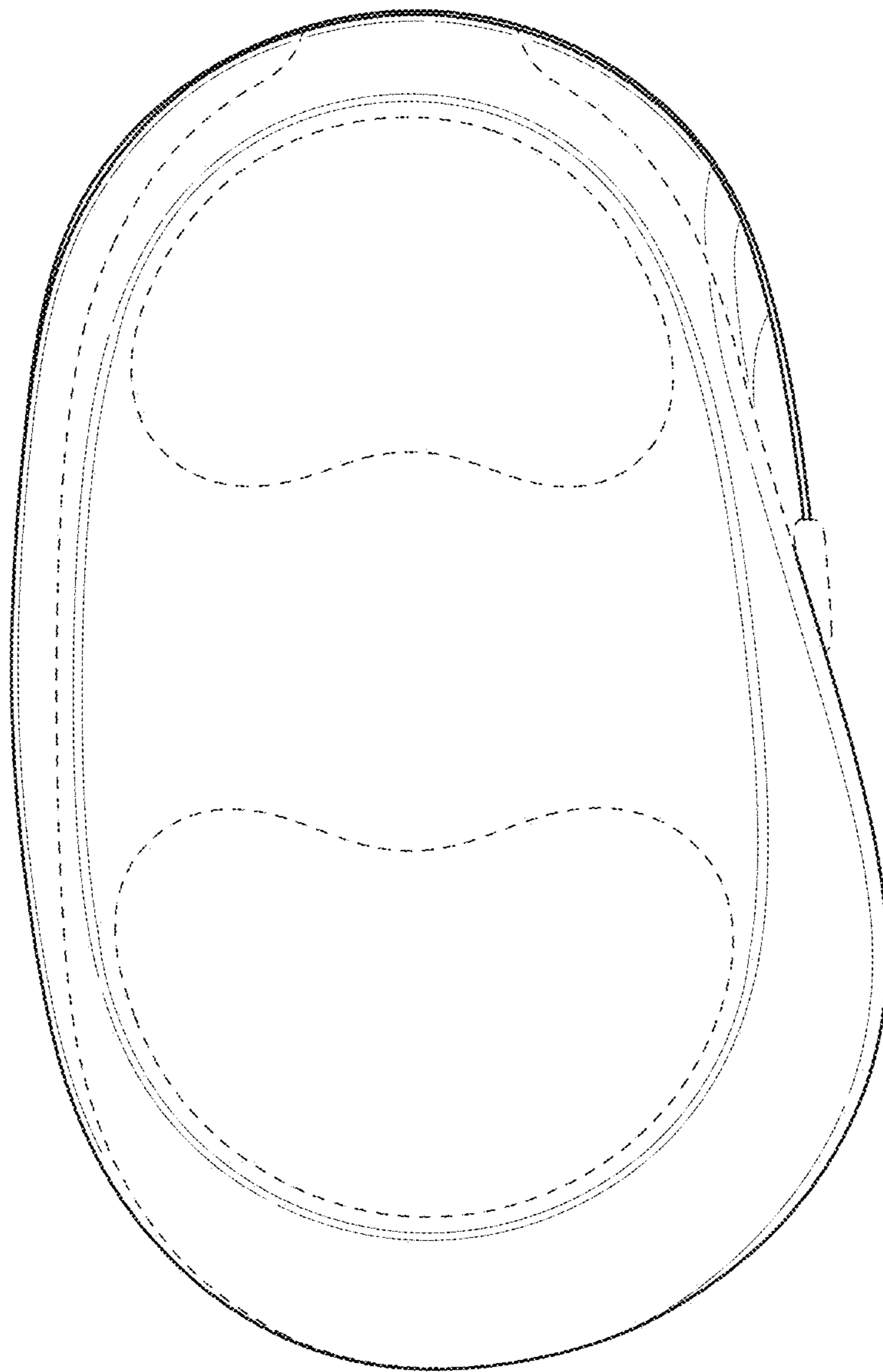

FIG. 5

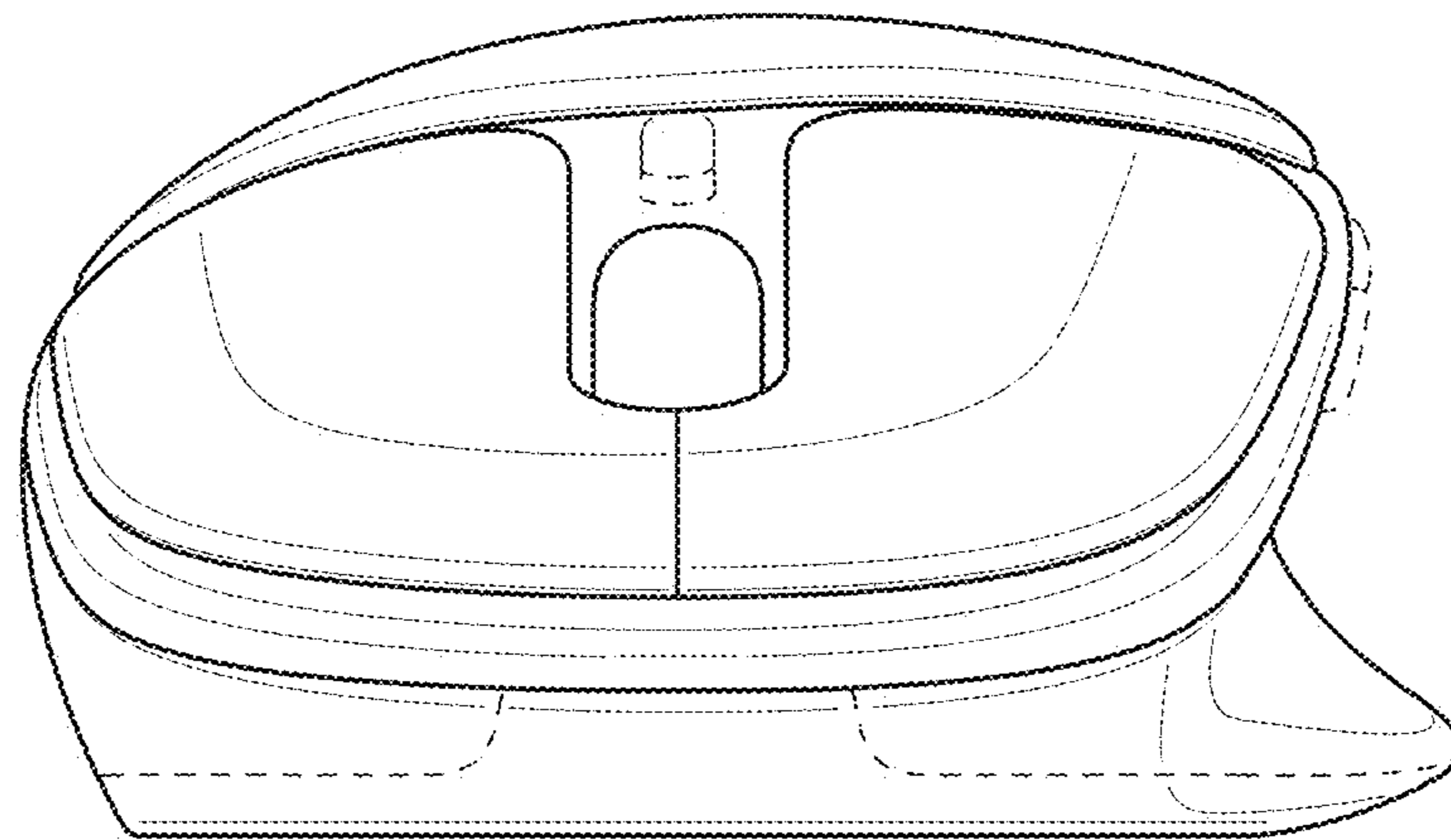

FIG. 6

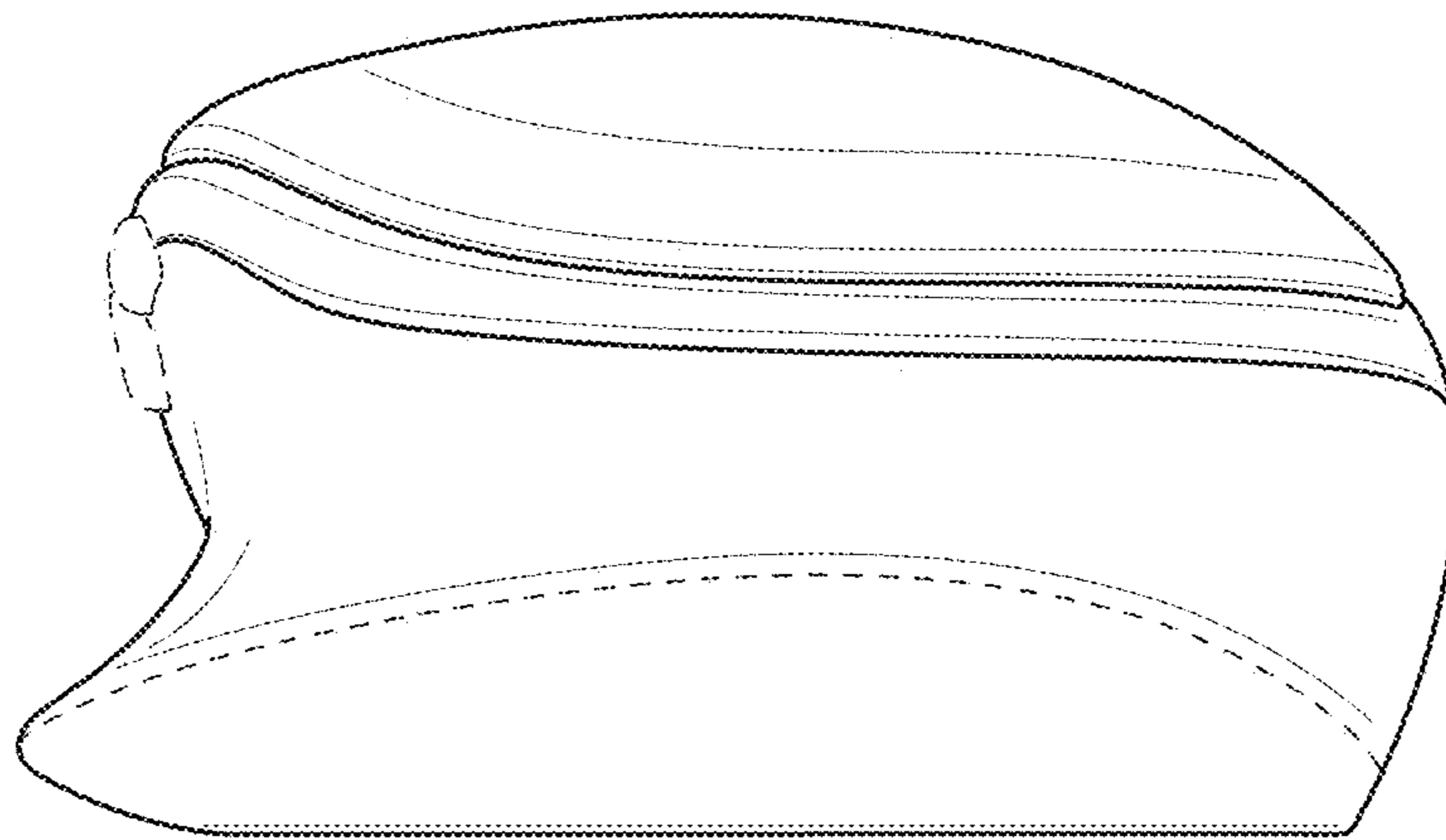

FIG. 7

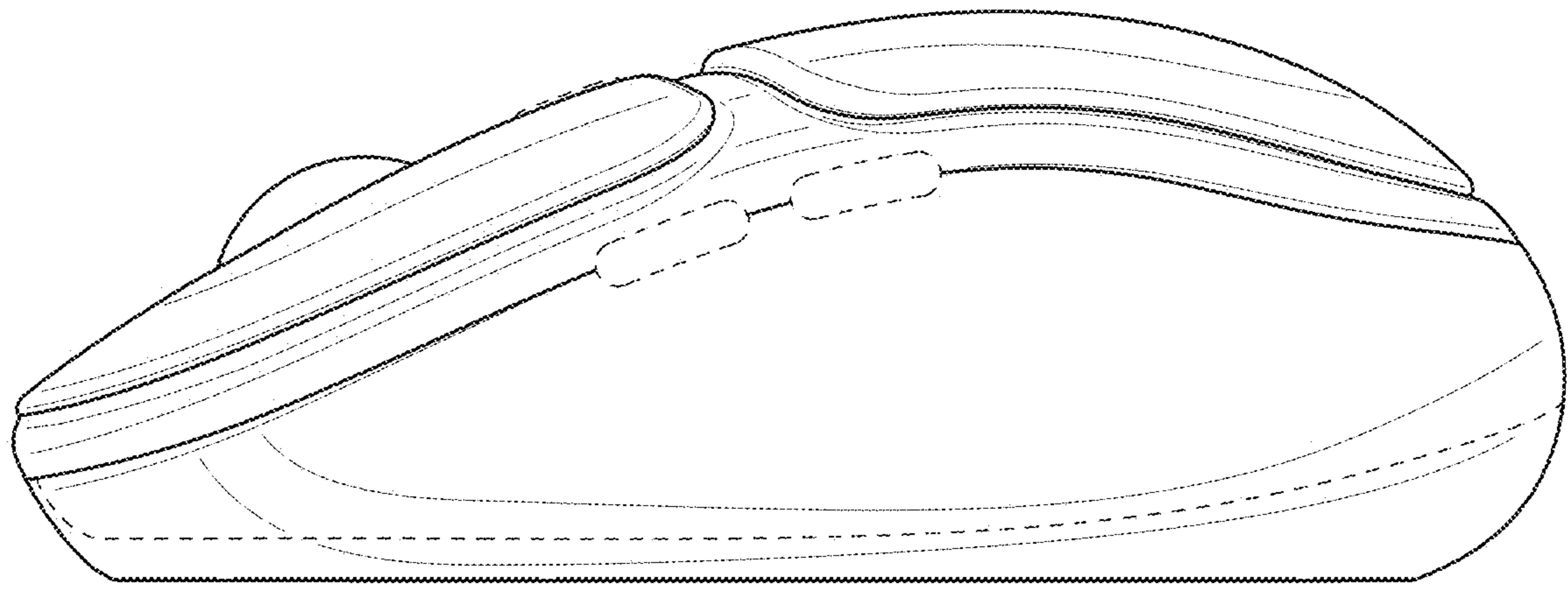

FIG. 8

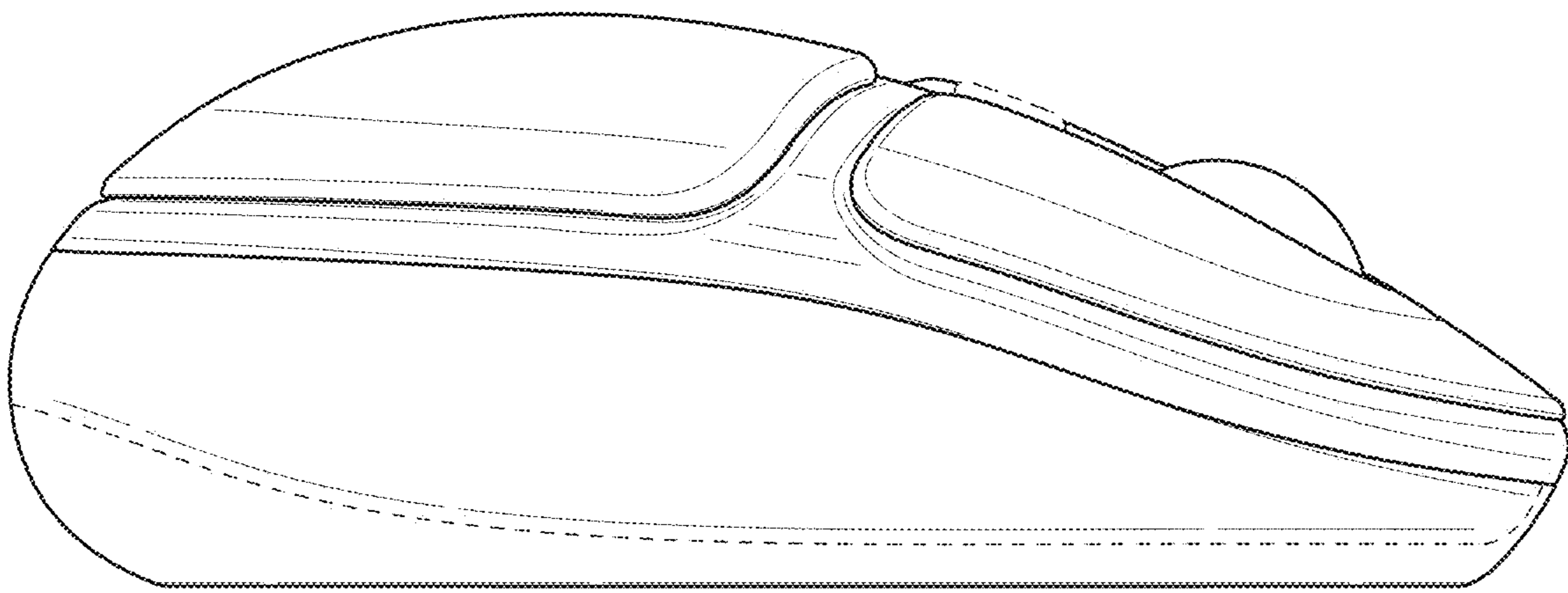

FIG. 9