



US00D983198S

(12) **United States Design Patent**
Brinkmann

(10) **Patent No.:** **US D983,198 S**

(45) **Date of Patent:** **** Apr. 11, 2023**

(54) **KEYBOARD**

(71) Applicant: **Tobias Brinkmann**, Clear Island Waters (AU)

(72) Inventor: **Tobias Brinkmann**, Clear Island Waters (AU)

(**) Term: **15 Years**

(21) Appl. No.: **29/772,904**

(22) Filed: **Mar. 4, 2021**

(51) **LOC (14) Cl.** **14-02**

(52) **U.S. Cl.**
USPC **D14/392**

(58) **Field of Classification Search**
USPC D14/12, 12.2, 383, 331-335, 338-340, D14/346, 347, 356, 384, 387-392, D14/395-401, 407, 416-417, 432, D14/454-457; D21/324, 333; D18/1, 2, D18/4.2

CPC B41J 5/107; B41J 5/10; B41J 5/12; B41J 5/14; B41J 7/34; G06F 3/0219; G06F 3/0231; G06F 3/0202; G06F 3/0213; G06F 3/03546; G06F 3/0359; G06F 3/0205; G06F 3/02

See application file for complete search history.

(56) **References Cited**

U.S. PATENT DOCUMENTS

D380,465 S *	7/1997	Chang	D14/395
D386,172 S *	11/1997	Kawauchi	D14/395
5,826,839 A *	10/1998	Chen	G06F 3/0221 248/118
5,829,899 A *	11/1998	Chao	G06F 3/0213 248/118
D405,777 S *	2/1999	Jasinski	D14/398
D439,902 S *	4/2001	Oba	D14/392
D445,792 S *	7/2001	Ji	D14/392
D488,814 S *	4/2004	Kang	D14/392
D556,758 S *	12/2007	Nguyen	D14/391

D580,446 S *	11/2008	DeMaio	D14/456
D583,818 S *	12/2008	Kuchler	D14/391
D643,037 S *	8/2011	Liang	D14/391

(Continued)

FOREIGN PATENT DOCUMENTS

CN	306817666	*	9/2021
CN	307316285	*	5/2022

(Continued)

OTHER PUBLICATIONS

Aula, "Gaming Keyboard and Mouse Combo . . ." available at amazon.com, date first available Jun. 10, 2022, date visited Sep. 20, 2022, Available at URL: <https://a.co/d/74MbFXc> (Year: 2022).*

(Continued)

Primary Examiner — Daniel J Domino
Assistant Examiner — Samina Vieth
(74) *Attorney, Agent, or Firm* — QuickPatents, LLC;
Kevin Prince

(57) **CLAIM**

The ornamental design for a keyboard, as shown and described.

DESCRIPTION

FIG. 1 is a top perspective view of a keyboard, showing my new design;
FIG. 2 is an exploded top perspective view thereof;
FIG. 3 is an exploded top plan view thereof;
FIG. 4 is an exploded left-side elevational view thereof;
FIG. 5 is an exploded right-side elevational view thereof;
FIG. 6 is an exploded front elevational view thereof; and,
FIG. 7 is an exploded rear elevational view thereof.
The bottom plan view of the keyboard is not claimed. The broken lines depict portions of the keyboard that form no part of the claimed design.

1 Claim, 7 Drawing Sheets

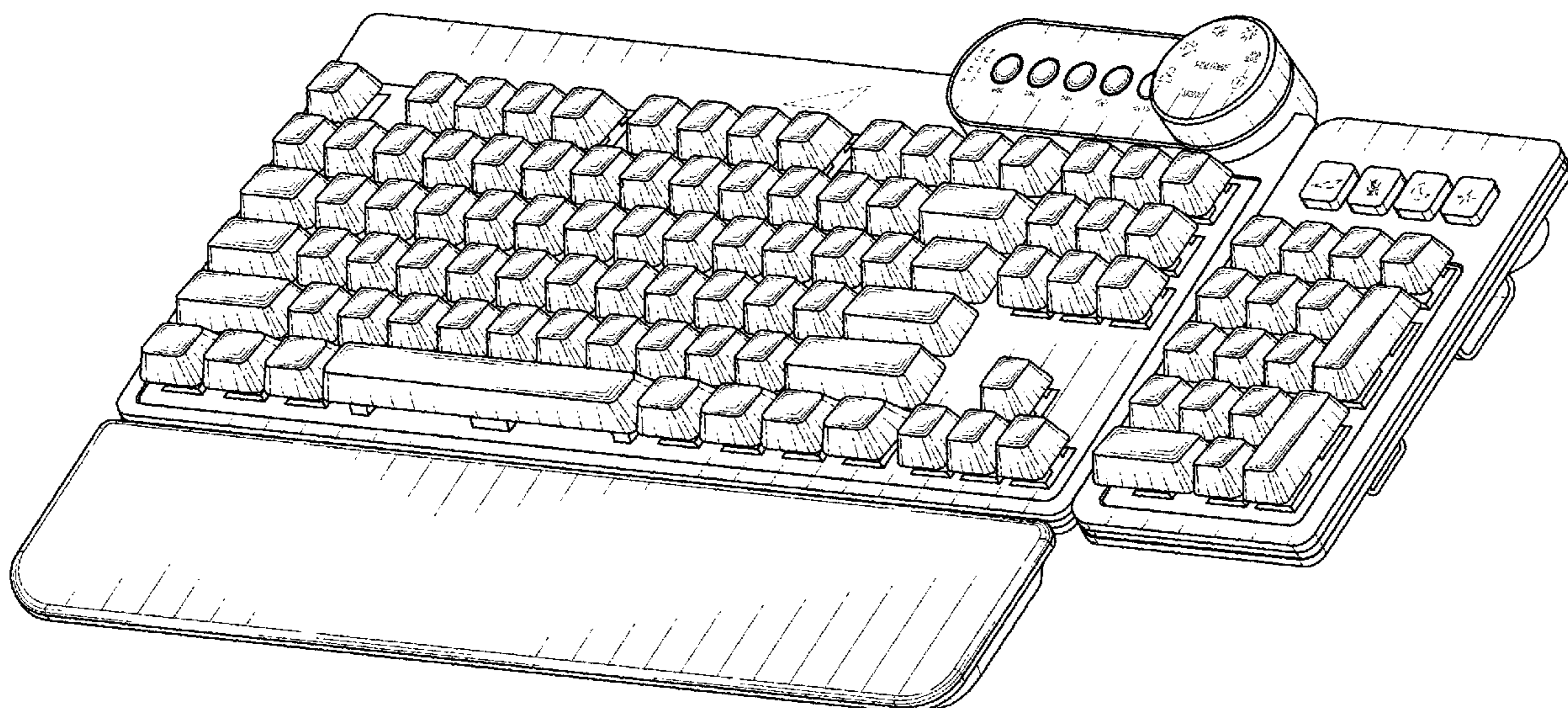

(56)

References Cited

U.S. PATENT DOCUMENTS

D780,756 S * 3/2017 Crisp D14/391
 D811,396 S * 2/2018 Tzeng D14/391
 10,310,626 B1 * 6/2019 Lu G06F 3/0221
 D934,248 S * 10/2021 Tong D14/392
 2003/0011496 A1 * 1/2003 Yu H01H 13/84
 341/23
 2003/0206761 A1 * 11/2003 Emerson G06F 3/0202
 400/489
 2004/0100447 A1 * 5/2004 Ozolins G06F 3/021
 345/170
 2005/0207817 A1 * 9/2005 Jenkins G06F 3/0219
 400/489
 2007/0045392 A1 * 3/2007 Youens G06F 3/0216
 235/145 R
 2008/0138136 A1 * 6/2008 Sauvage G06F 3/0216
 400/488
 2009/0261991 A1 * 10/2009 Su H01H 13/7057
 341/22
 2010/0073855 A1 * 3/2010 Liang G06F 3/0219
 361/679.08
 2013/0222990 A1 * 8/2013 Yu G06F 3/0221
 361/679.2
 2014/0240238 A1 * 8/2014 Norwalk G06F 3/0221
 345/168

FOREIGN PATENT DOCUMENTS

CN 307348780 * 5/2022
 CN 307486406 * 8/2022

OTHER PUBLICATIONS

Havit, "Wired Gaming Keyboard Mouse . . ." available at amazon.com, date first available Oct. 21, 2015, date visited Sep. 20, 2022, Available at URL: <https://a.co/d/f4ppOtZ> (Year: 2015).*

Shortcircuit, "This Gaming Keyboard is really Advanced!. . ." available at youtube.com, date published May 15, 2021, date visited Sep. 20, 2022, Available at URL: <https://www.youtube.com/watch?v=FLrWfrFIMMU> (Year: 2021).*

RedThunder, "K900 Gaming Keyboard RGB Backlit Semi Mechanical Keyboard . . .", available at amazon.com, date first available May 14, 2018, Available at URL: <https://a.co/d/8UrLmUM> (Year: 2018).*

* cited by examiner

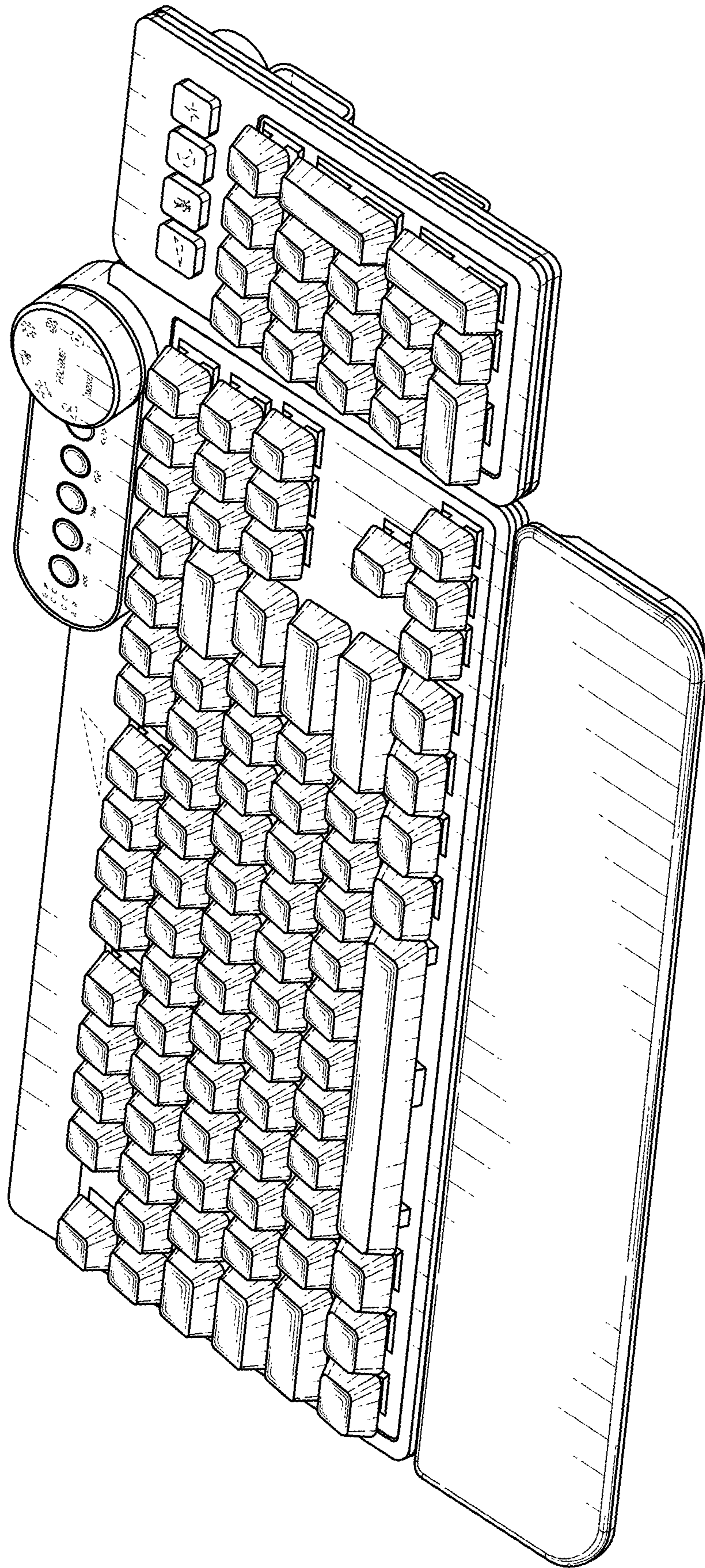

FIG. 1

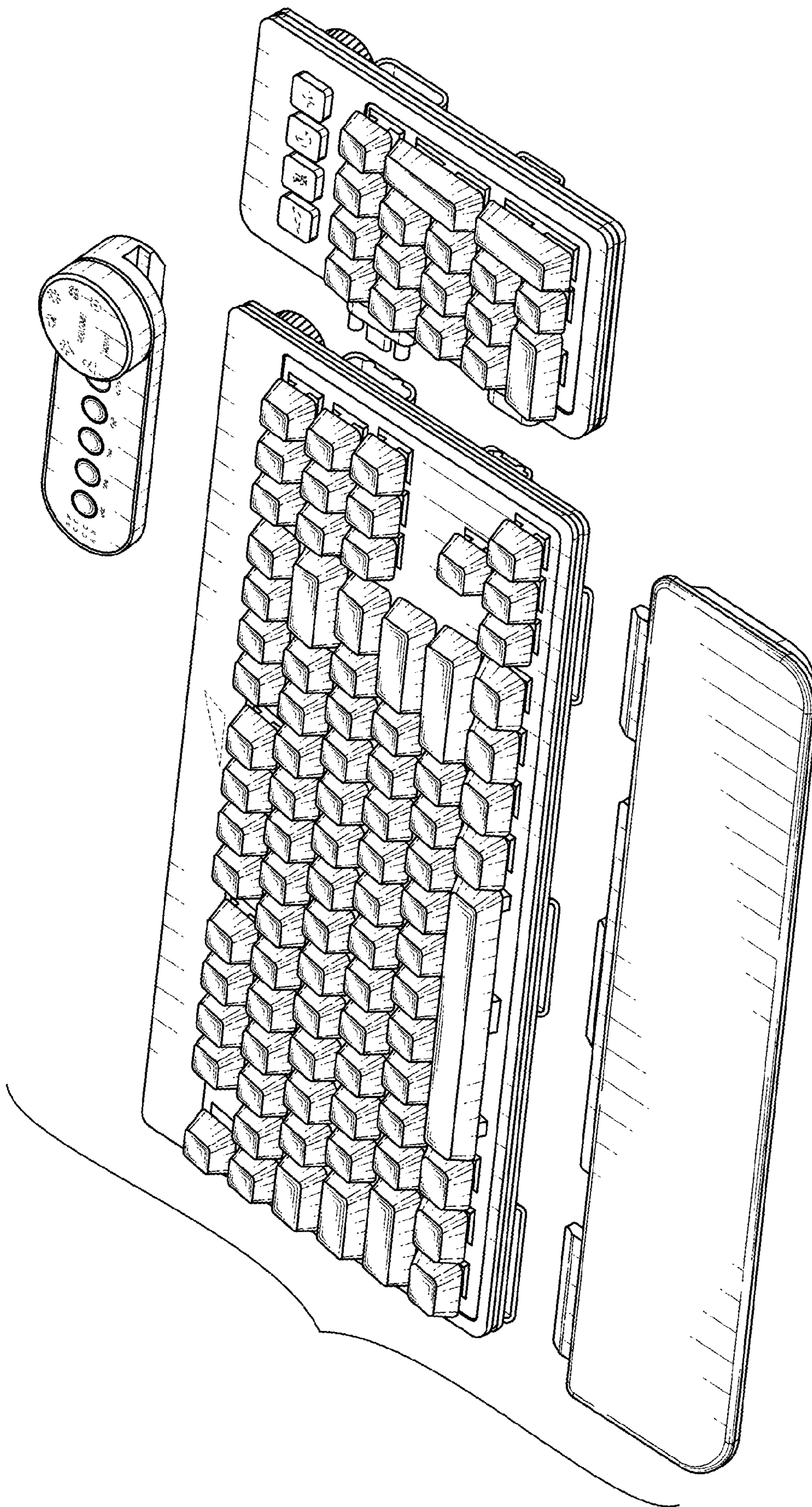

FIG. 2

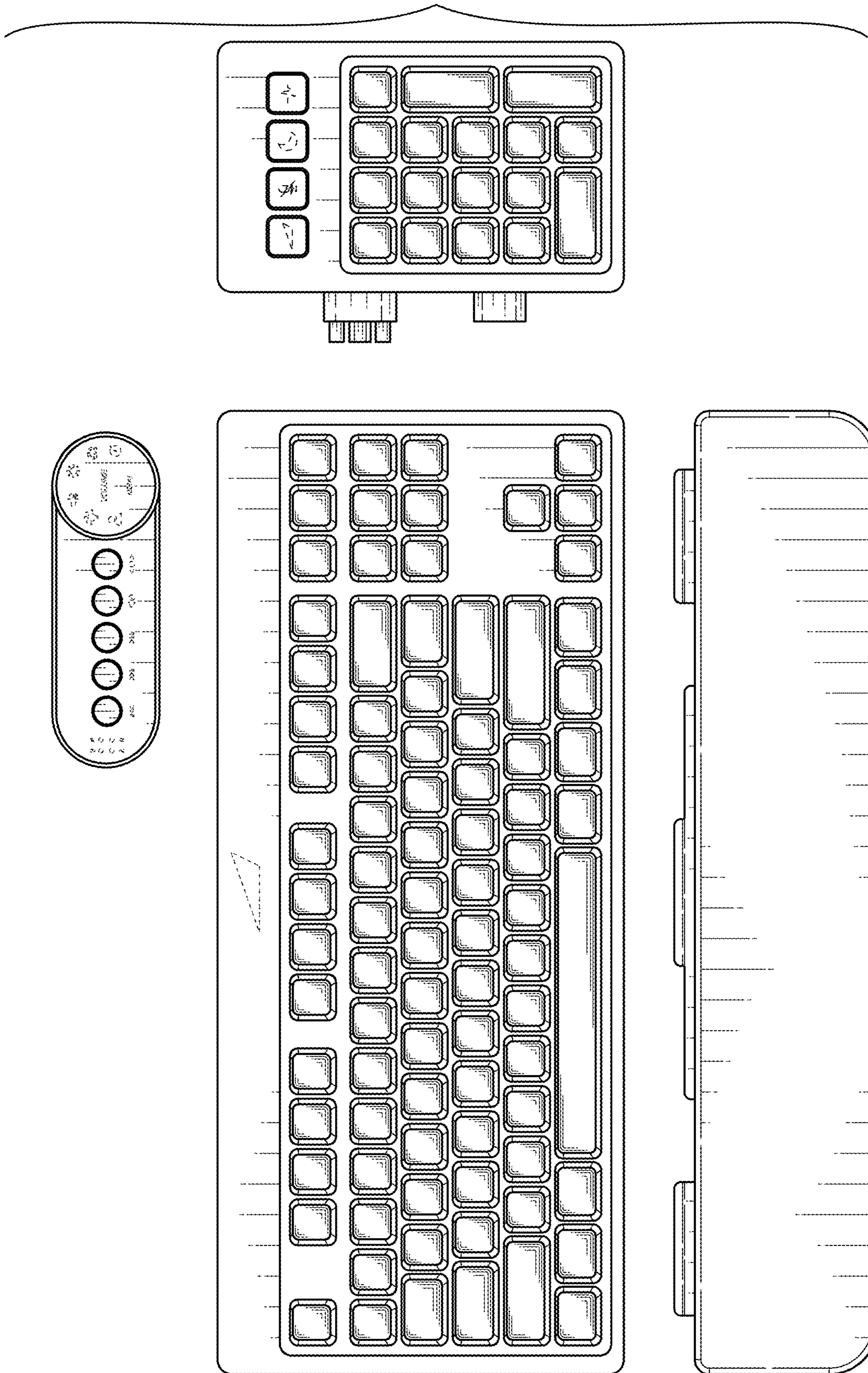

FIG. 3

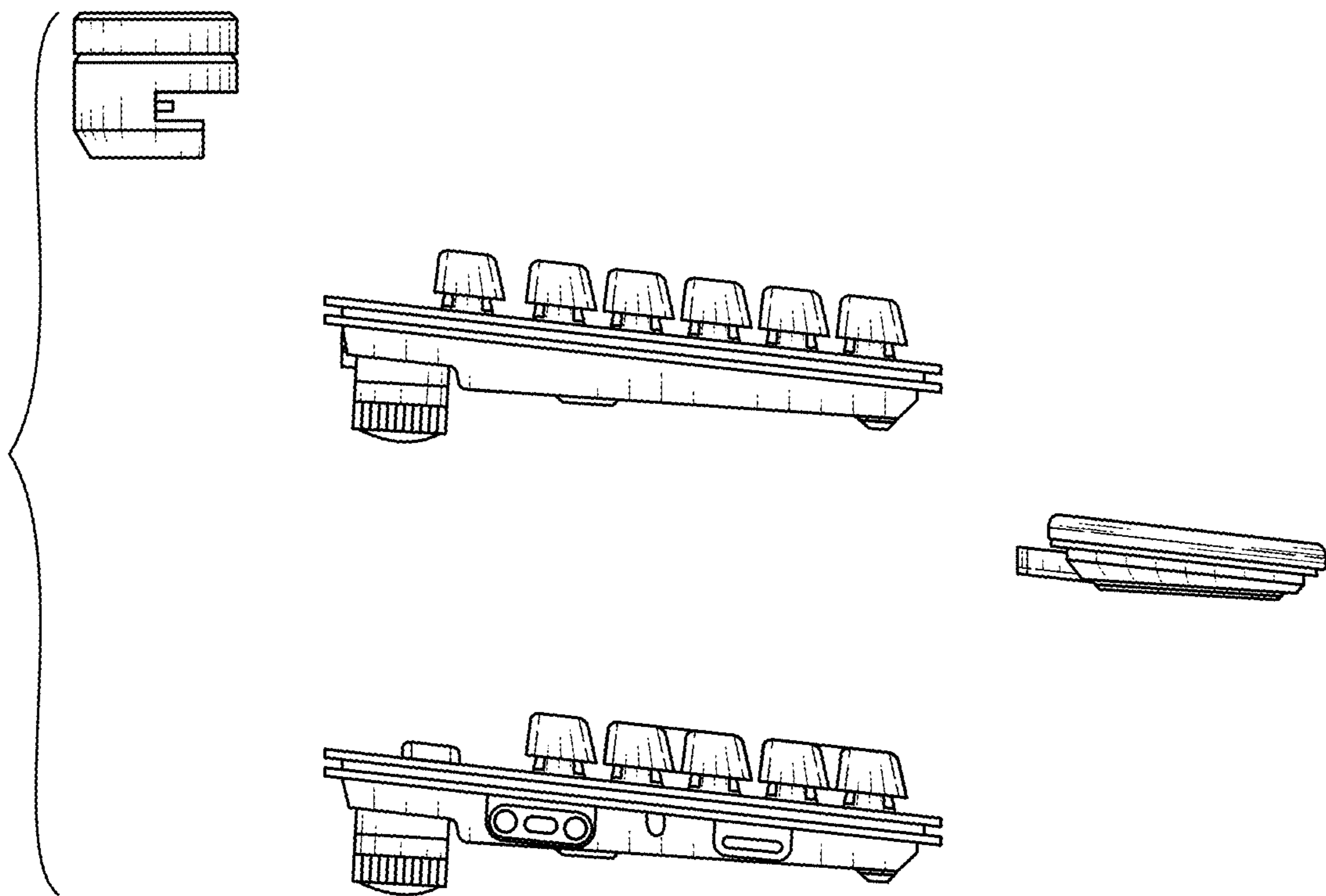

FIG. 4

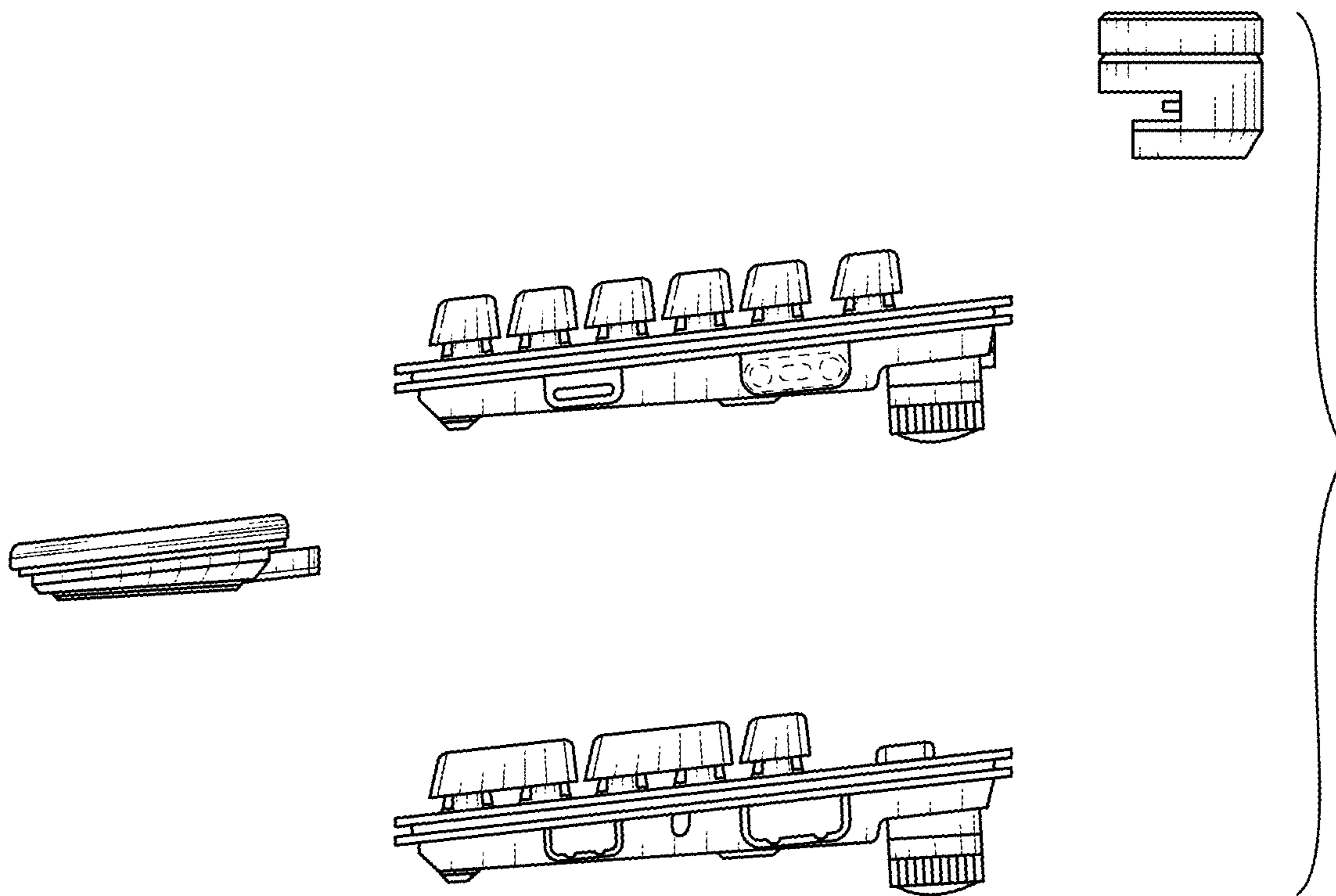

FIG. 5

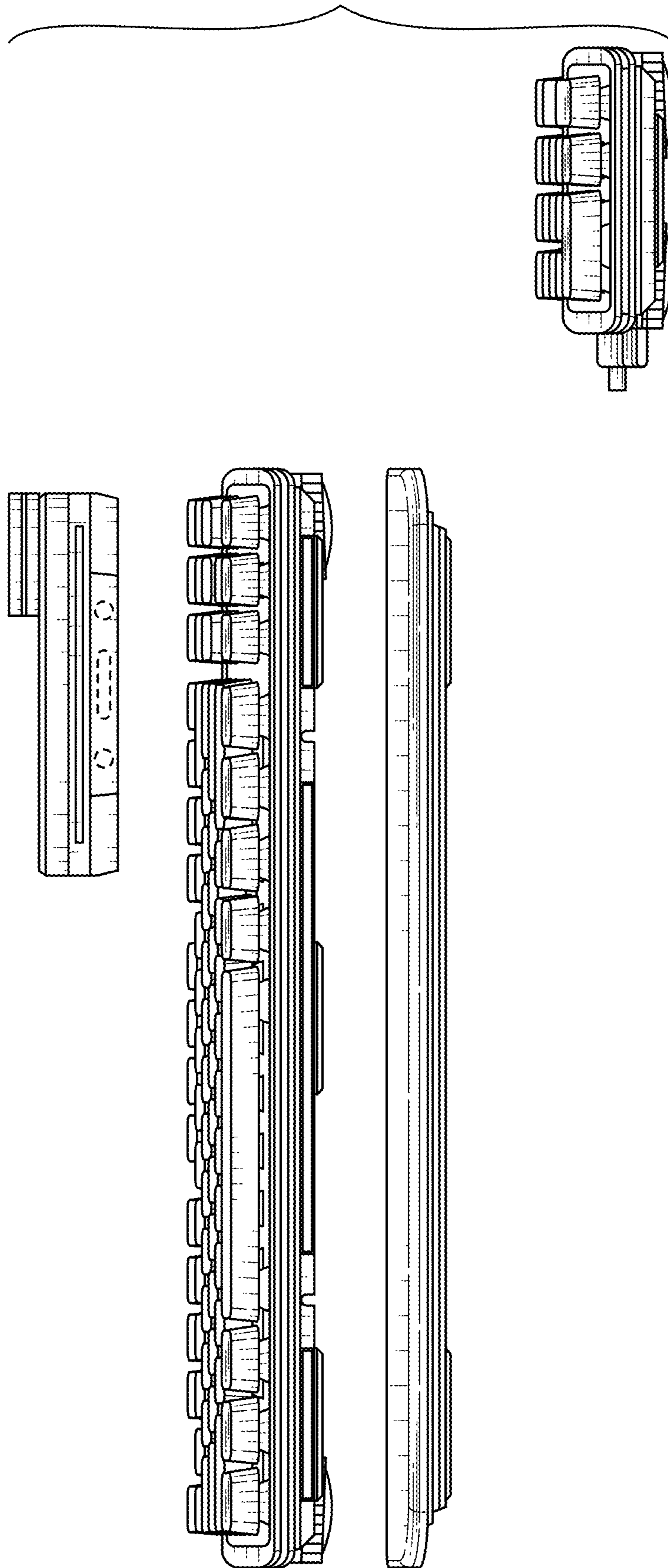

FIG. 6

