



US00D983080S

(12) **United States Design Patent** (10) **Patent No.:** **US D983,080 S**
Bugdaycay (45) **Date of Patent:** **** Apr. 11, 2023**

(54) **JEWELRY LINK**

(71) Applicant: **Elizabeth A. Bugdaycay**, New York, NY (US)

(72) Inventor: **Elizabeth A. Bugdaycay**, New York, NY (US)

(**) Term: **15 Years**

(21) Appl. No.: **29/801,742**

(22) Filed: **Jul. 30, 2021**

(51) **LOC (14) Cl.** **11-01**

(52) **U.S. Cl.**
USPC **D11/93**

(58) **Field of Classification Search**

USPC D11/1, 79, 86, 93, 3, 6, 12, 13, 14, 15,
D11/16, 17, 18, 40, 87, 97, 103, 200;
D21/483, 493; D8/349, 354, 382
CPC A44C 1/00; A44C 25/00; A44C 25/001;
A44C 25/007; A44C 3/008; A44C 11/00;
A44C 5/02; A44C 5/18; A44C 5/105;
A44C

(Continued)

(56) **References Cited**

U.S. PATENT DOCUMENTS

D116,839 S * 9/1939 Dieterich D11/93
D175,876 S * 10/1955 Armbrust D11/13

(Continued)

OTHER PUBLICATIONS

FoundRae Strong Hearts Love link chain. Online [website], Instagram, posted online by user @foundrae on Nov. 1, 2022 [retrieved on Nov. 15, 2022]. (Year: 2022).*

Primary Examiner — Tracey J Bell

Assistant Examiner — Grace Doyle

(74) *Attorney, Agent, or Firm* — Cozen O'Connor

(57) **CLAIM**

The ornamental design for a jewelry link, as shown and described.

DESCRIPTION

FIG. 1 shows a perspective view of the claimed jewelry link; FIG. 2 shows a front view thereof; FIG. 3 shows a rear view thereof; FIG. 4 shows a top view thereof; FIG. 5 shows a bottom view thereof; FIG. 6 shows a left-side end view; FIG. 7 shows a right-side end view; FIG. 8 shows the jewelry link with environmental structure shown in broken line; FIG. 9 shows the jewelry link with environmental structure shown in broken line; FIG. 10 shows the jewelry link with environmental structure shown in broken line; FIG. 11 shows another embodiment of a jewelry link with heart-shaped cross sections oriented differently from the orientation of FIG. 1; FIG. 12 shows a top view of the jewelry link of FIG. 11; FIG. 13 shows a bottom view of the jewelry link of FIG. 11; FIG. 14 shows a left-side end view of the jewelry link of FIG. 11; FIG. 15 shows a right-side end view of the jewelry link of FIG. 11; FIG. 16 shows a left-side end view of the jewelry link of FIG. 11; FIG. 17 shows a right-side end view of the jewelry link of FIG. 11; FIG. 18 shows the jewelry link of FIG. 11 with environmental structure shown in broken line; FIG. 19 shows the jewelry link of FIG. 11 with environmental structure shown in broken line; and, FIG. 20 shows the jewelry link of FIG. 11 with environmental structure shown in broken line. The broken line showing of jewelry is for the purpose of illustrating environmental structure and forms no part of the claimed design.

1 Claim, 14 Drawing Sheets

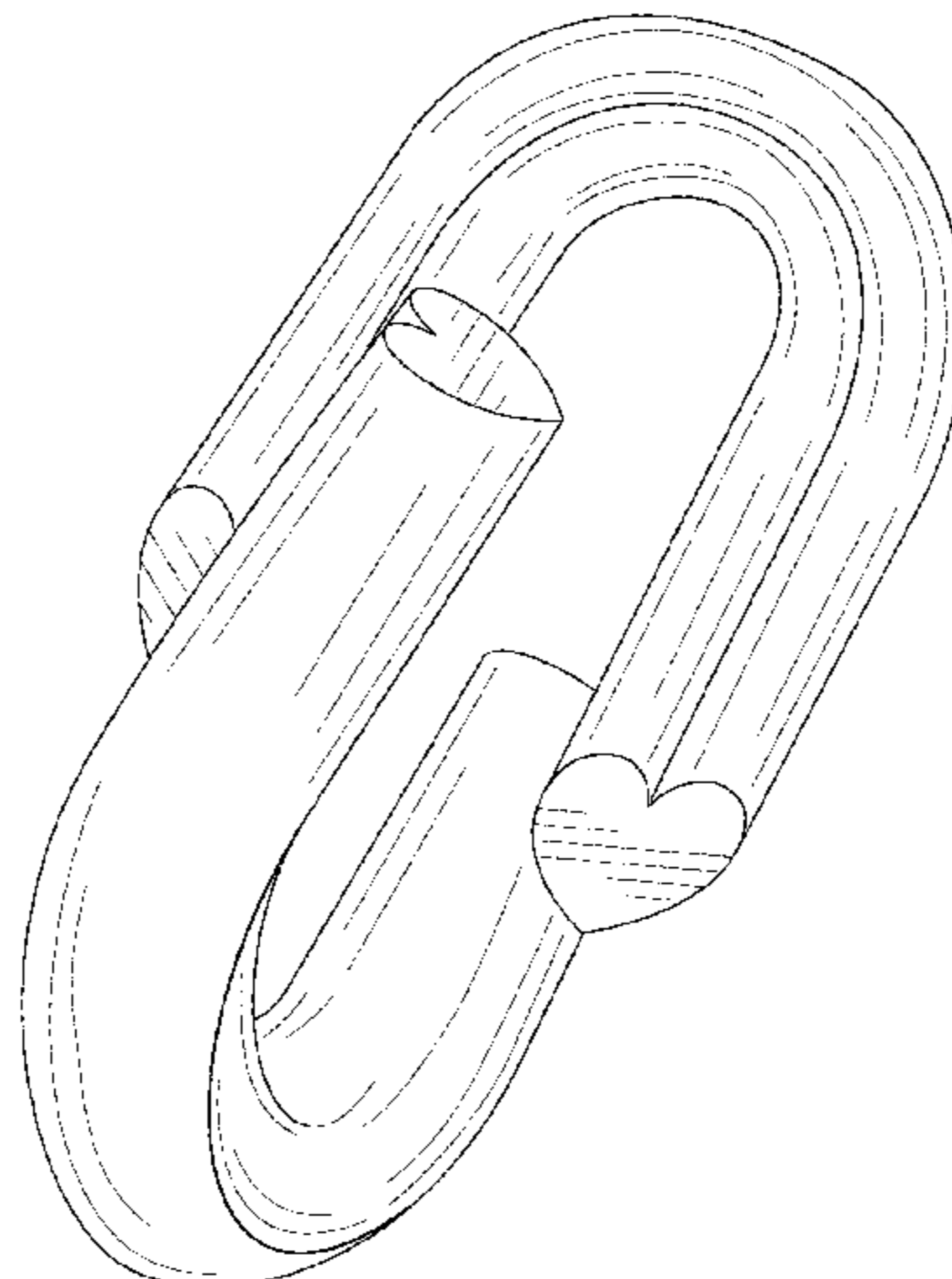

(58) **Field of Classification Search**

CPC ... 5/0038; A44C 5/0092; A44C 15/005; B60C
27/083

See application file for complete search history.

(56) **References Cited**

U.S. PATENT DOCUMENTS

2,821,034	A	*	1/1958	Baker	A01K 11/00
						D11/97
D221,730	S	*	9/1971	Marietta	D8/394
D598,805	S	*	8/2009	Hardy	D11/93
D701,565	S	*	3/2014	Lin	D19/65
D722,913	S	*	2/2015	Aagaard	D11/93
D729,106	S	*	5/2015	Shlakman	D11/91
D799,940	S	*	10/2017	Kelleghan	D8/356
D905,588	S	*	12/2020	Yamada	A01K 11/00
						D11/79
D955,750	S	*	6/2022	Miguel	D11/221

* cited by examiner

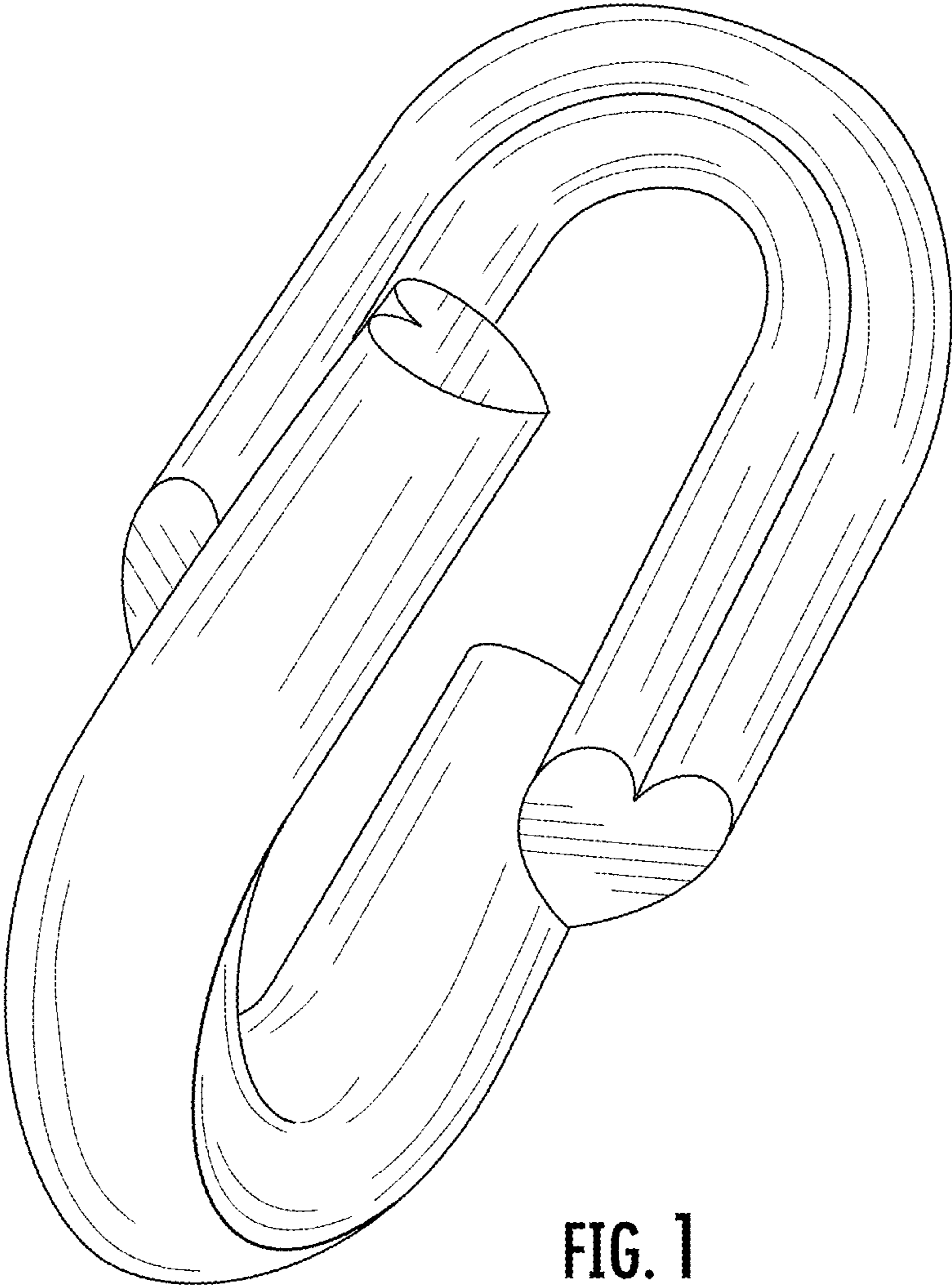

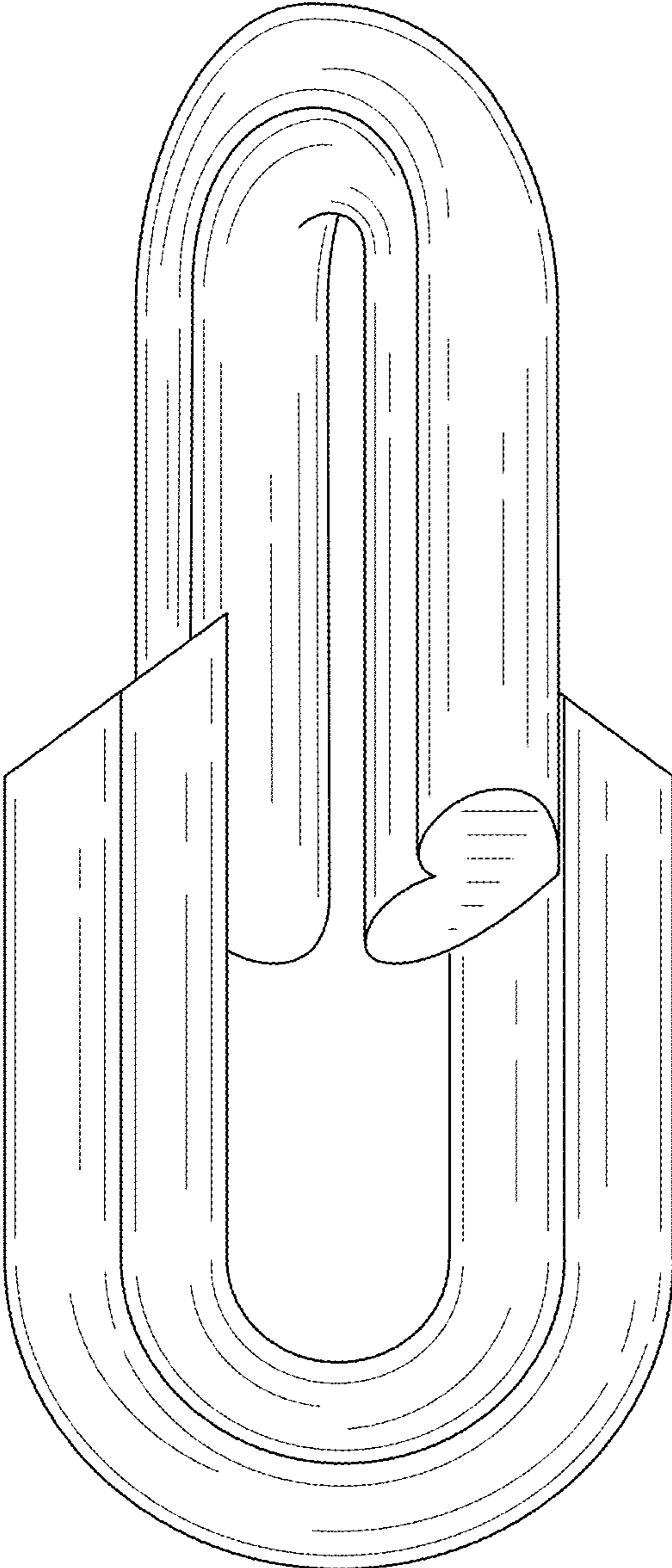

FIG. 2

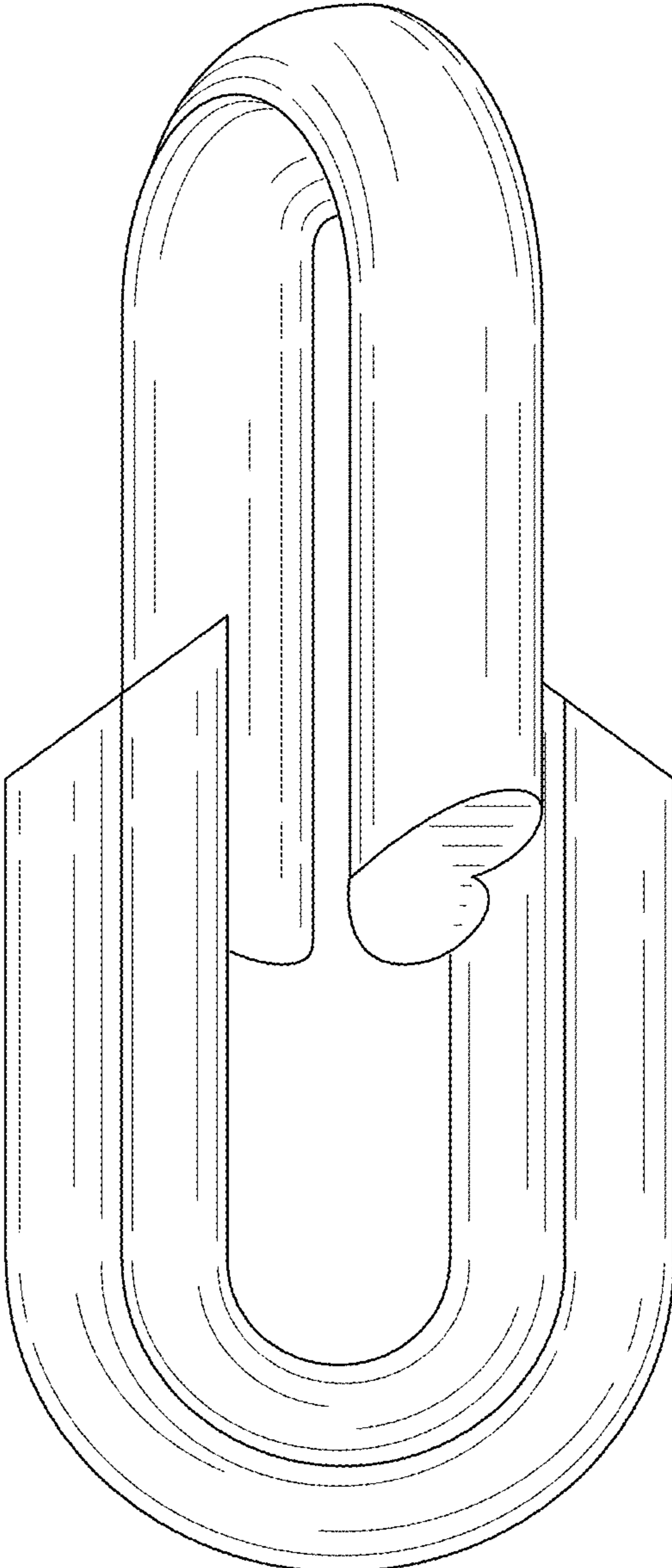

FIG. 3

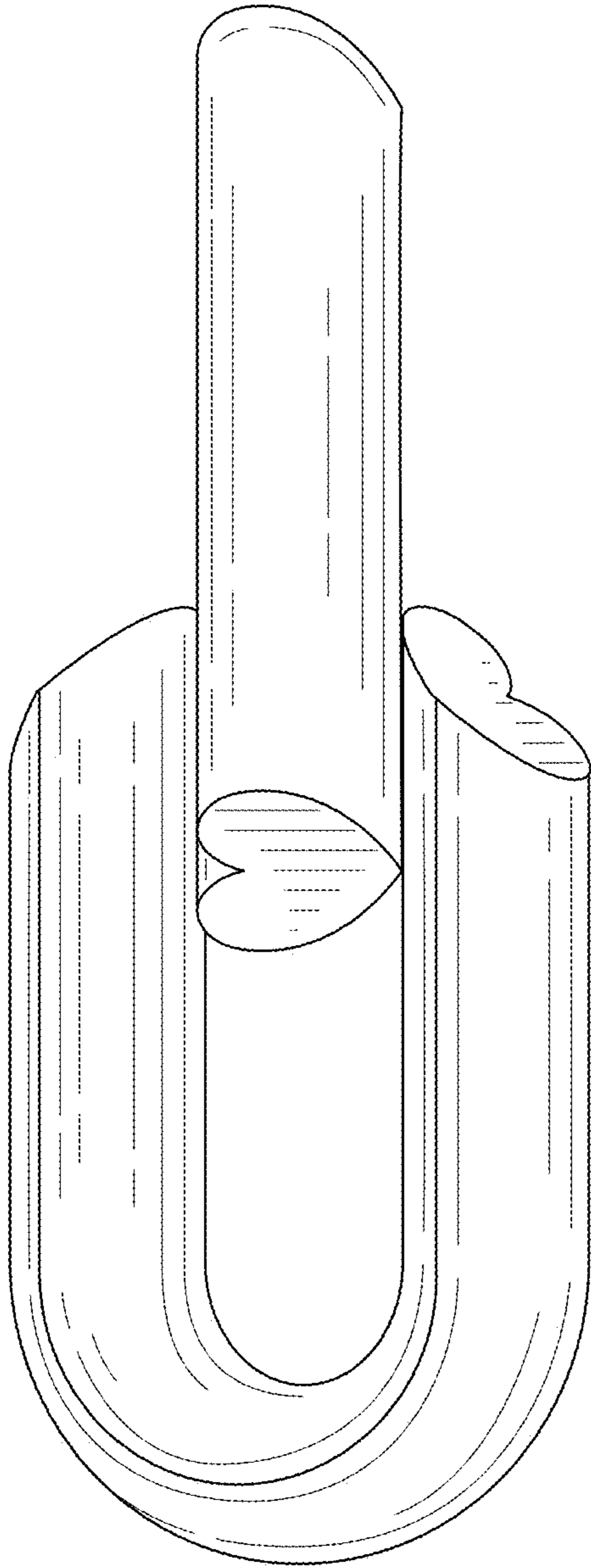

FIG. 4

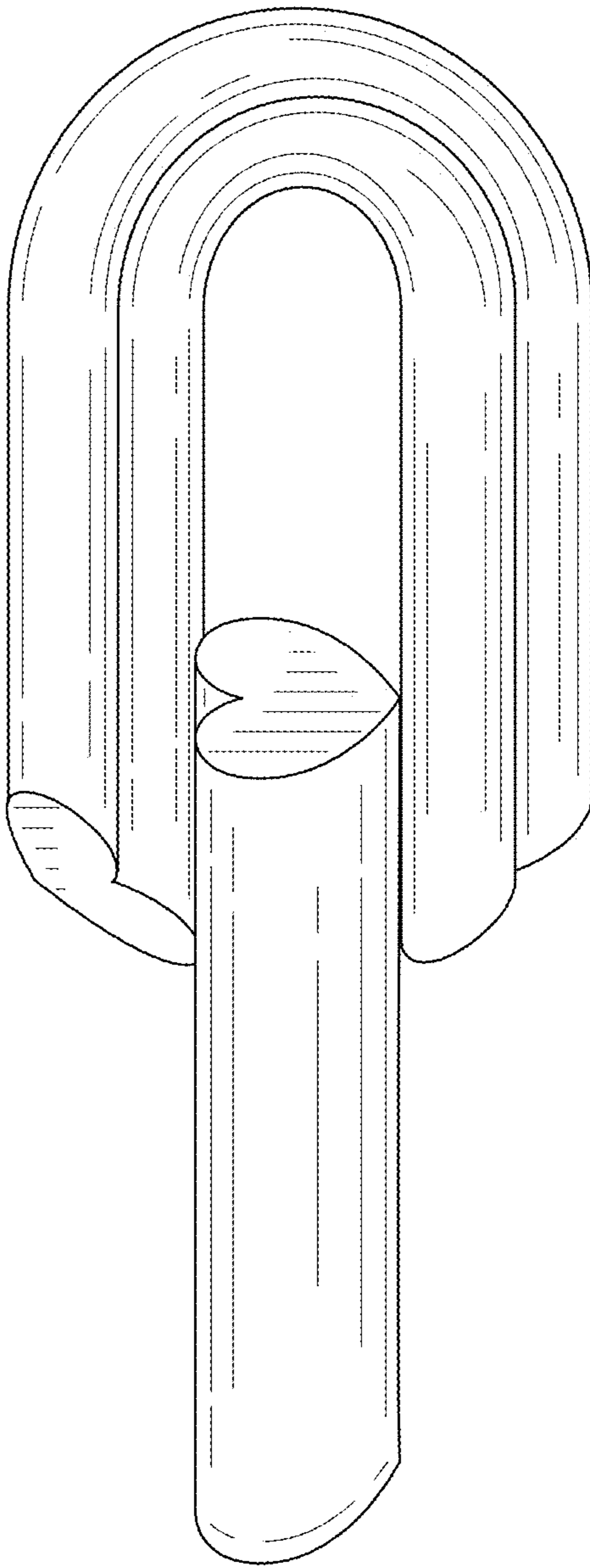

FIG. 5

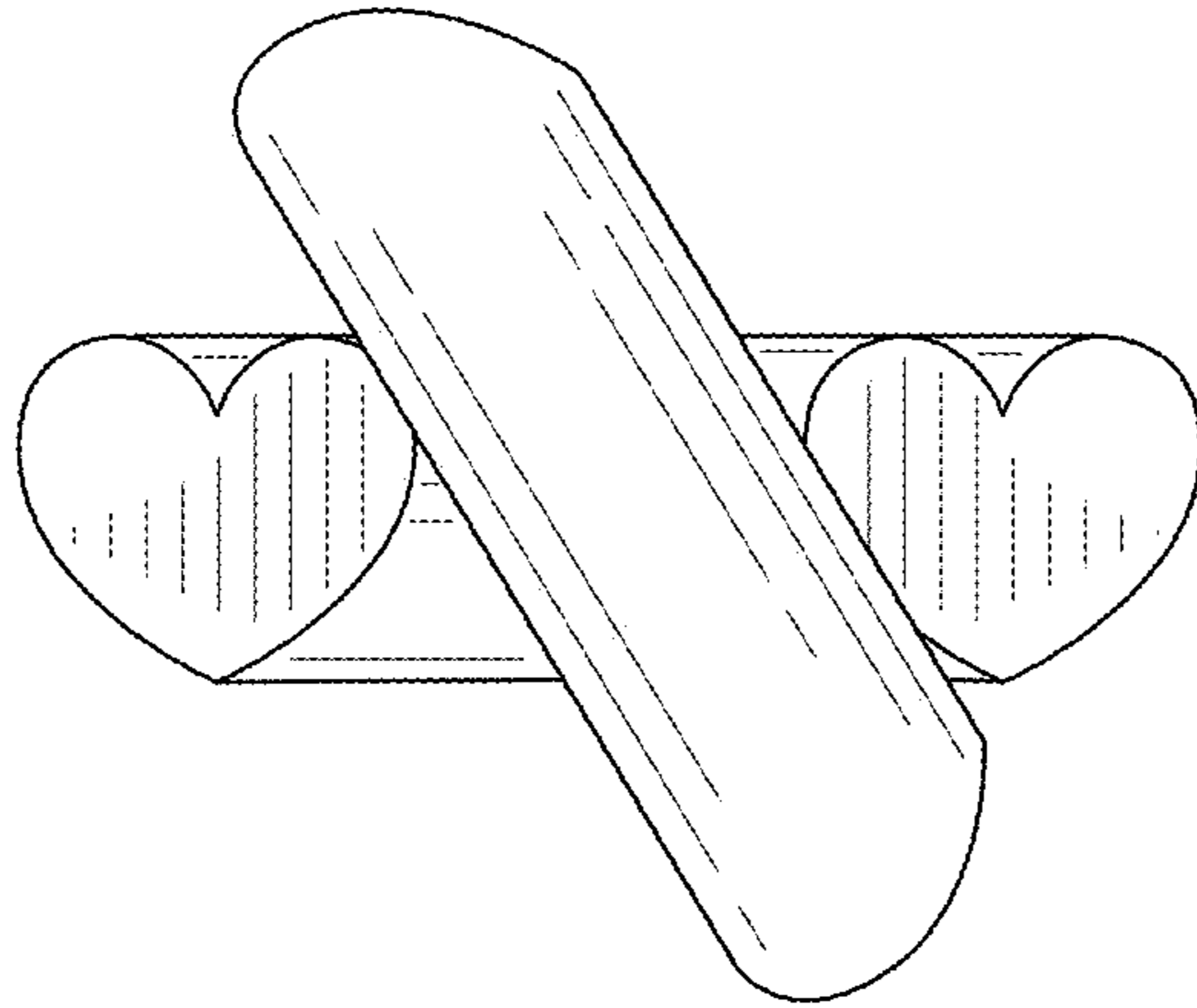

FIG. 6

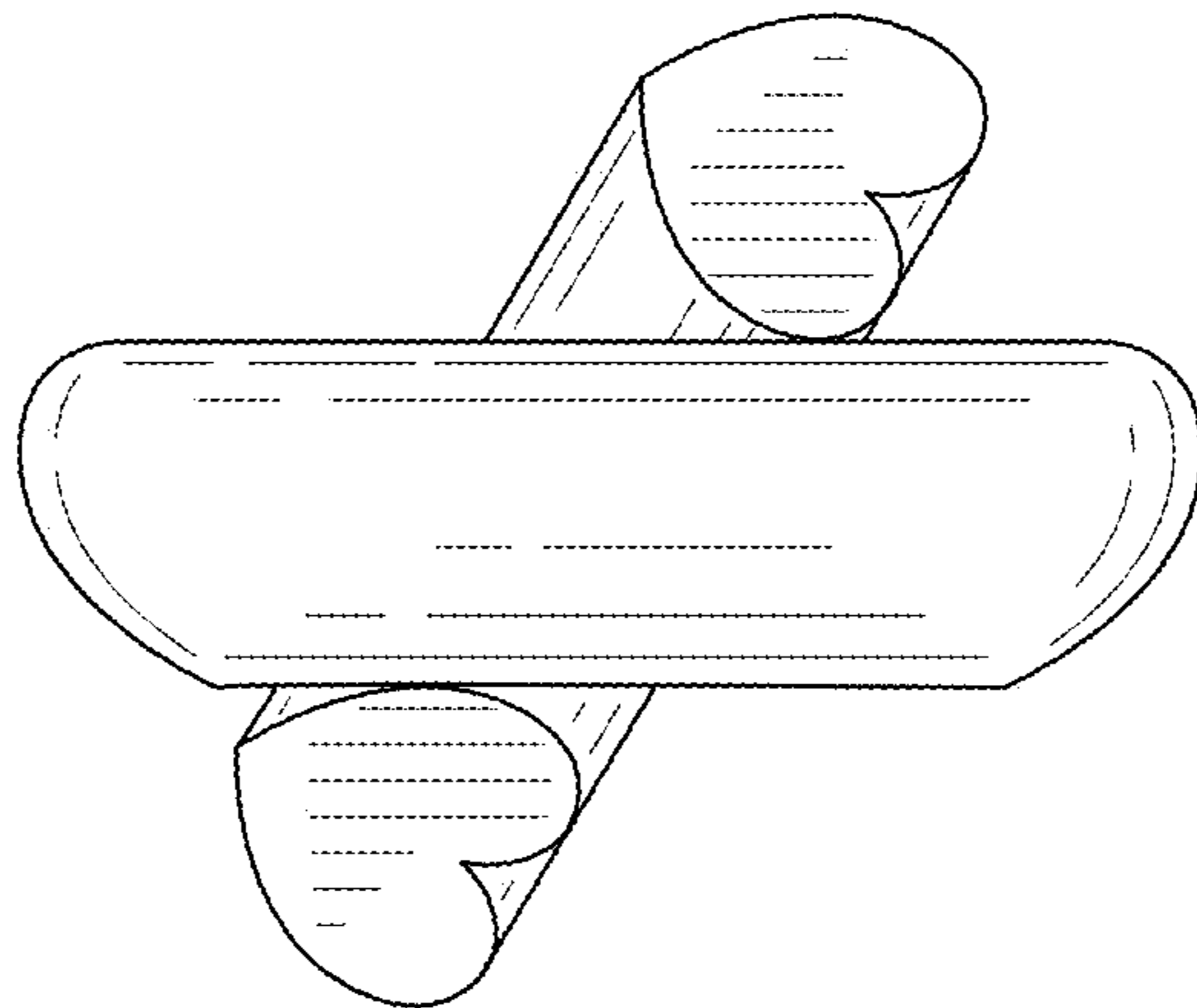

FIG. 7

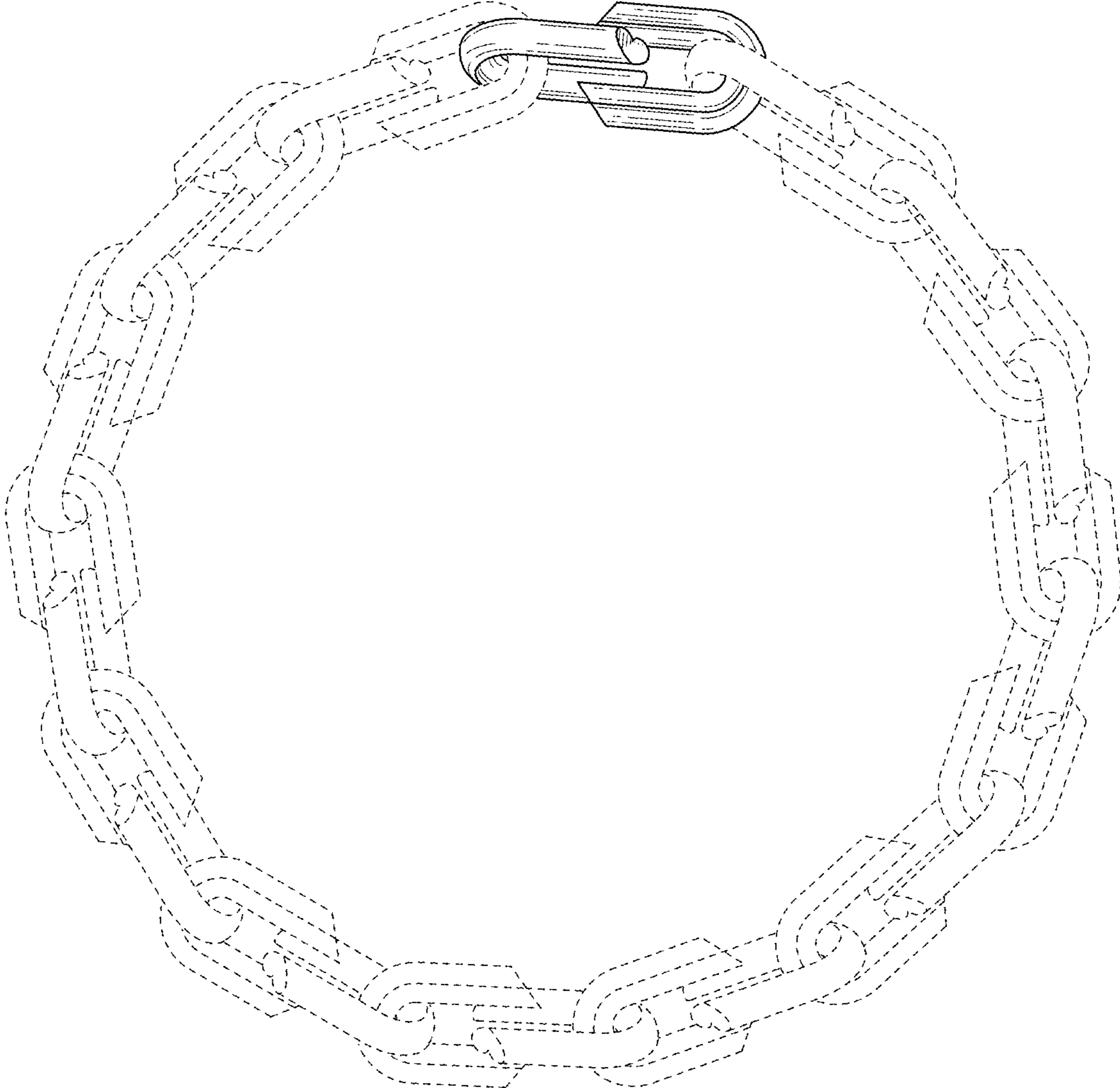

FIG. 8



FIG. 9

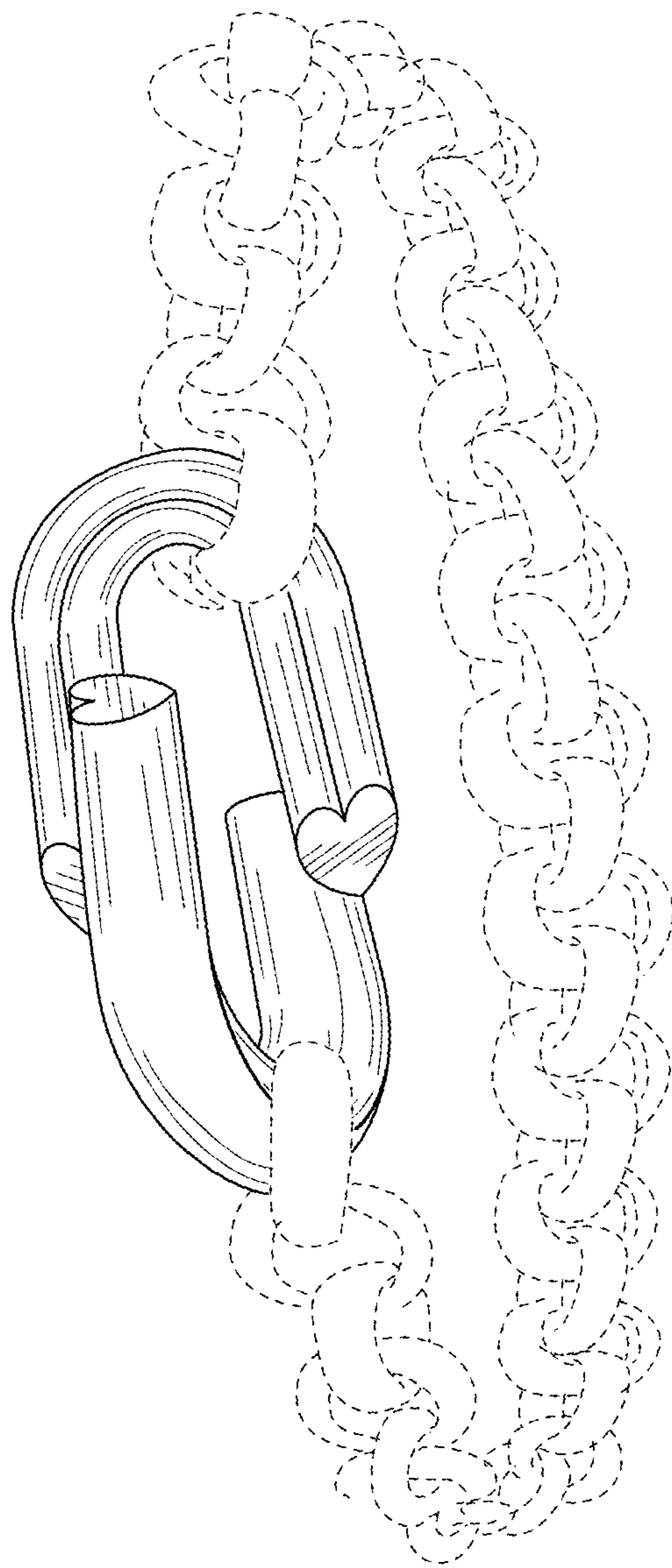

FIG. 10

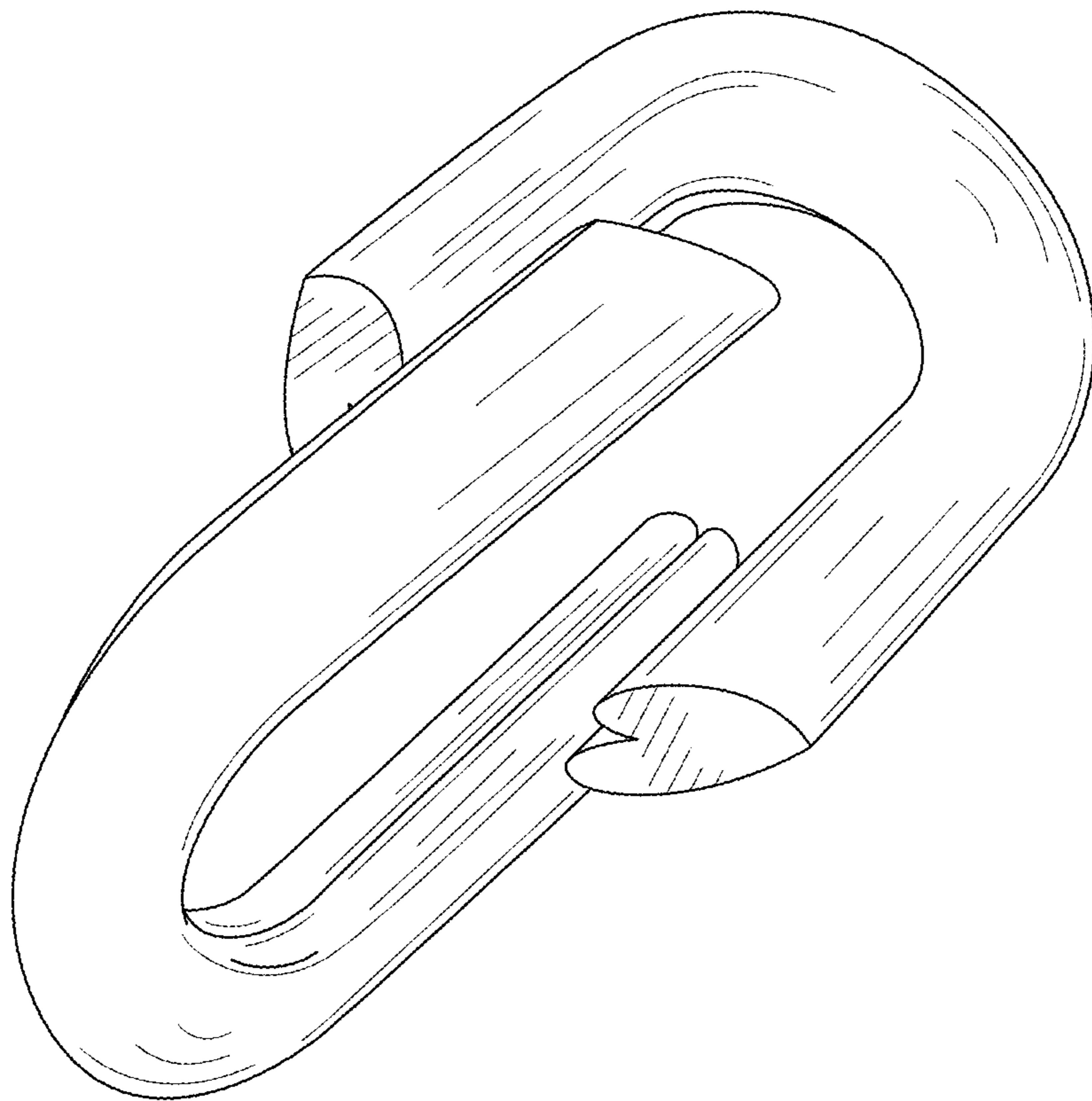

FIG. 11

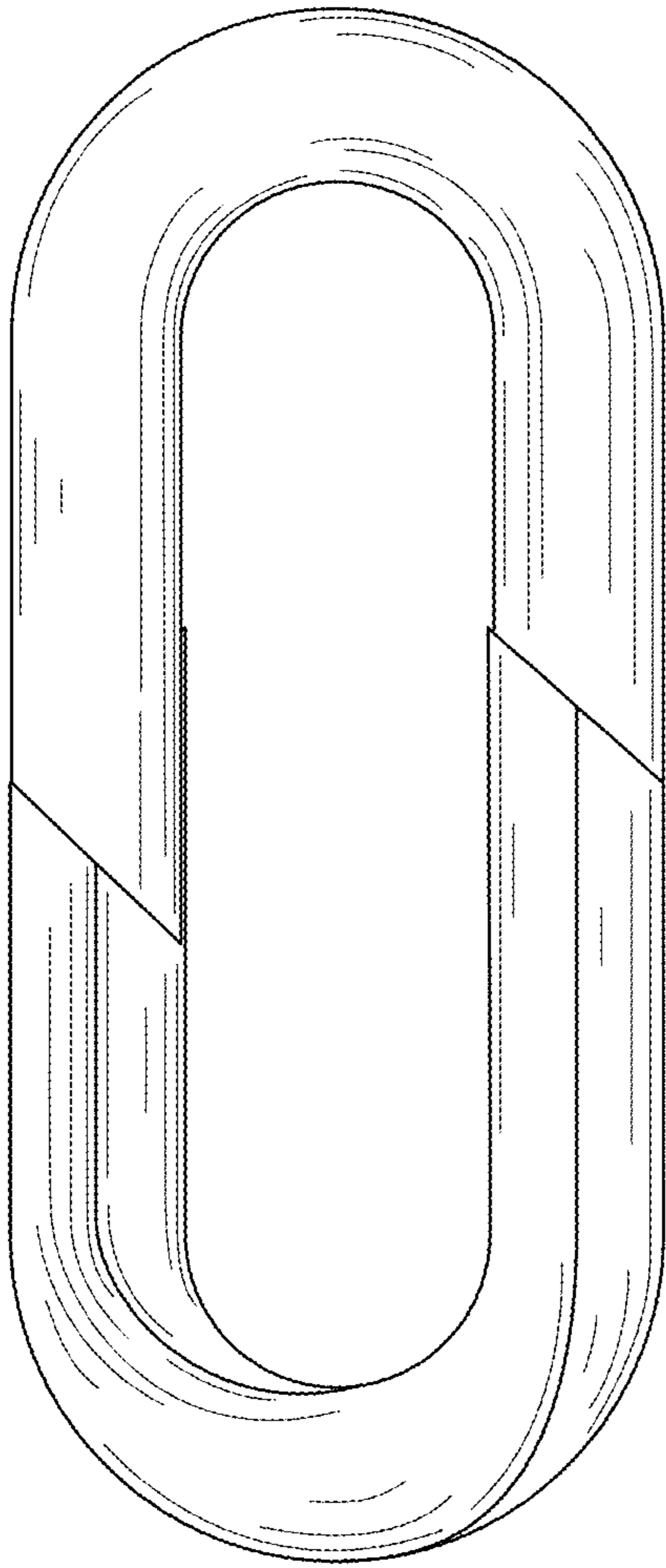

FIG. 12

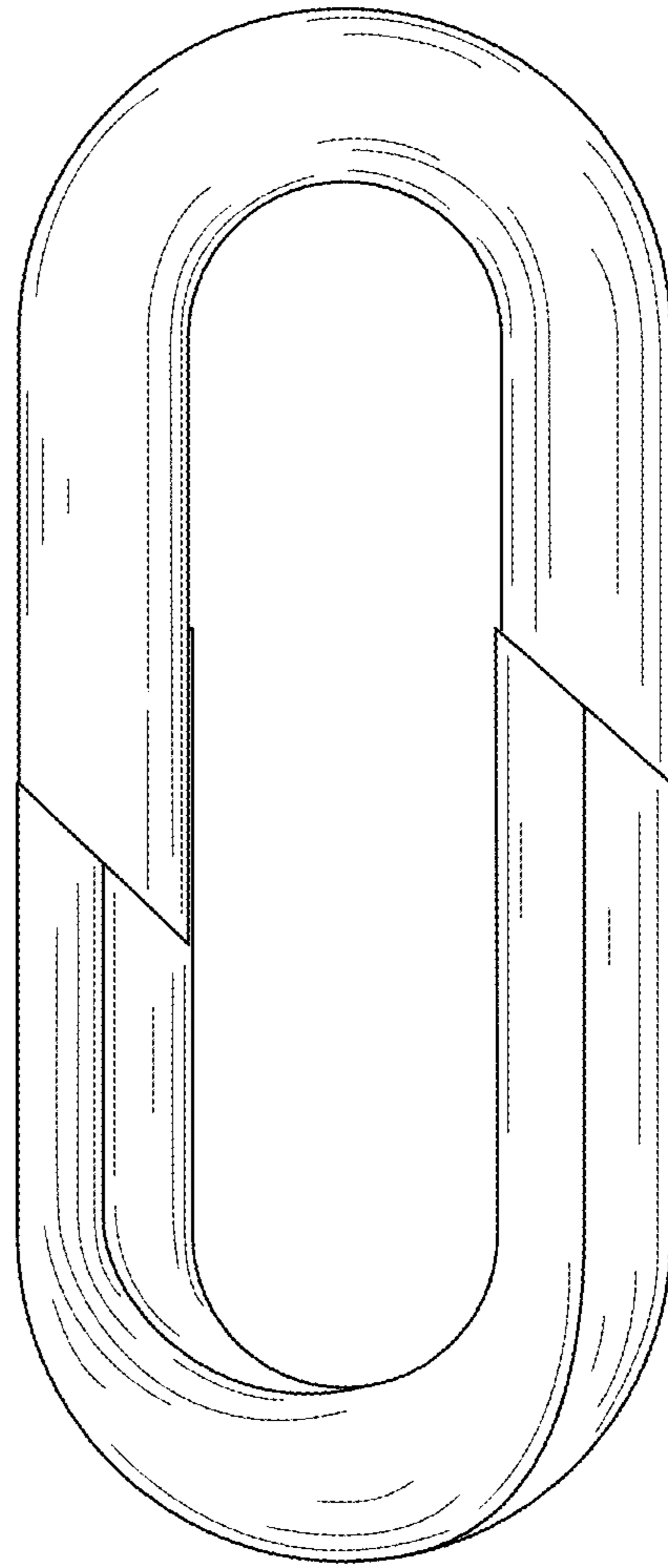

FIG. 13

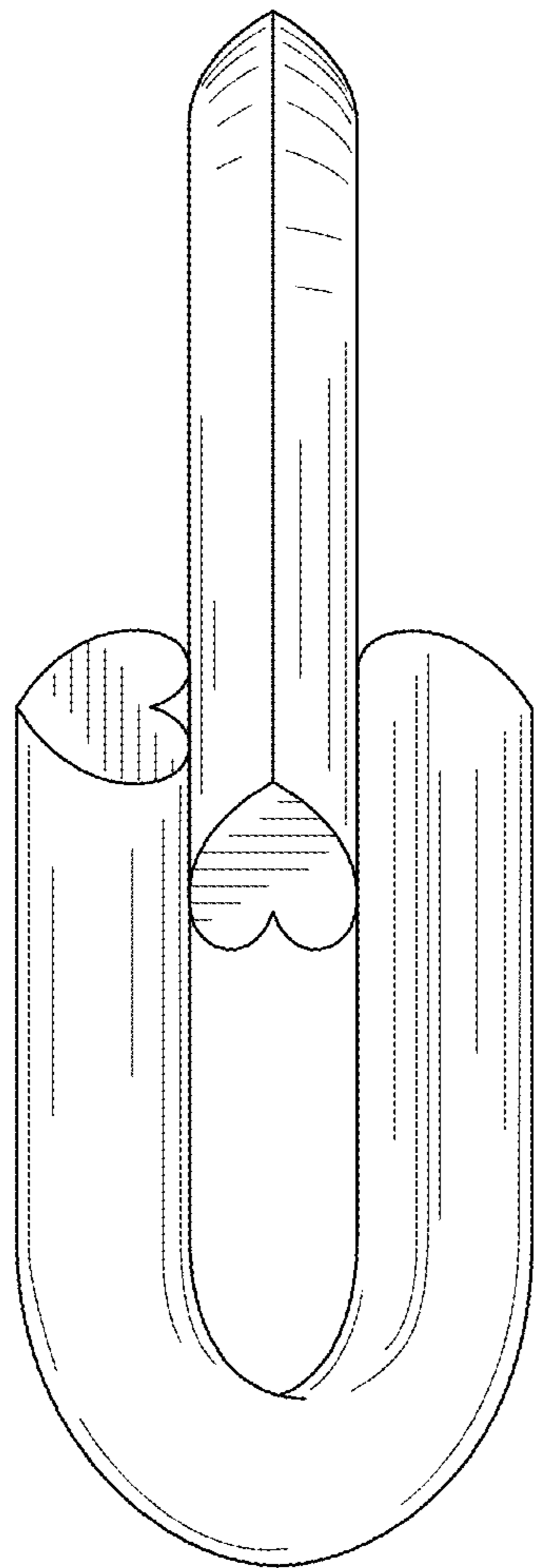

FIG. 14

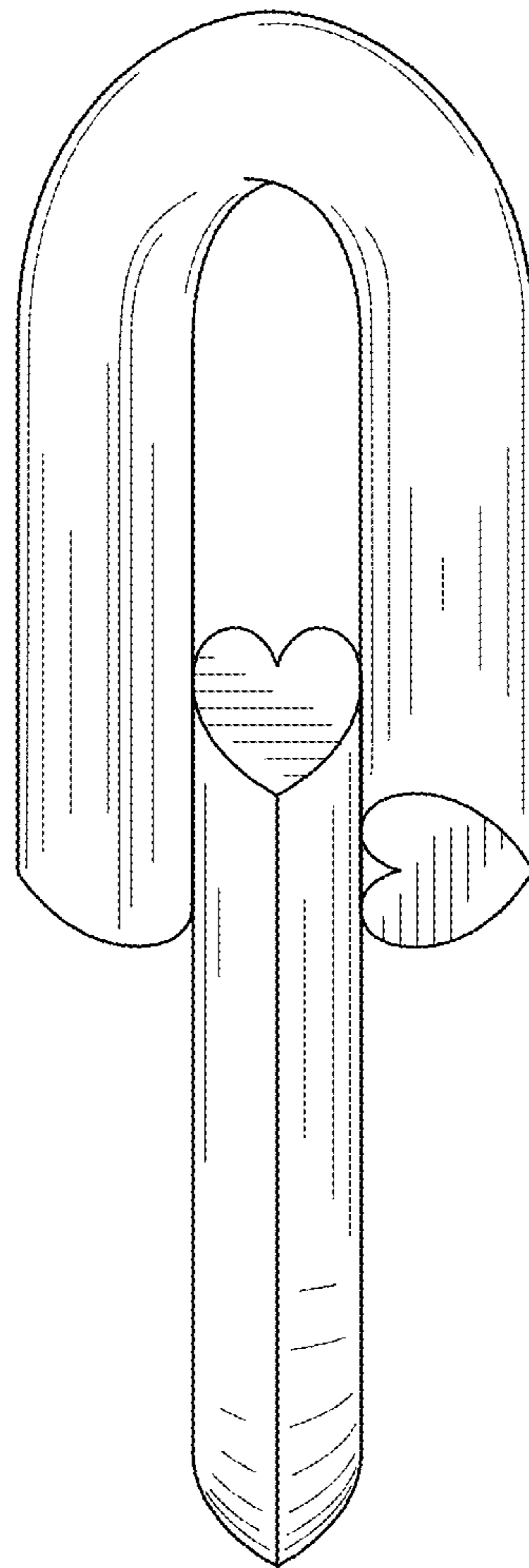

FIG. 15

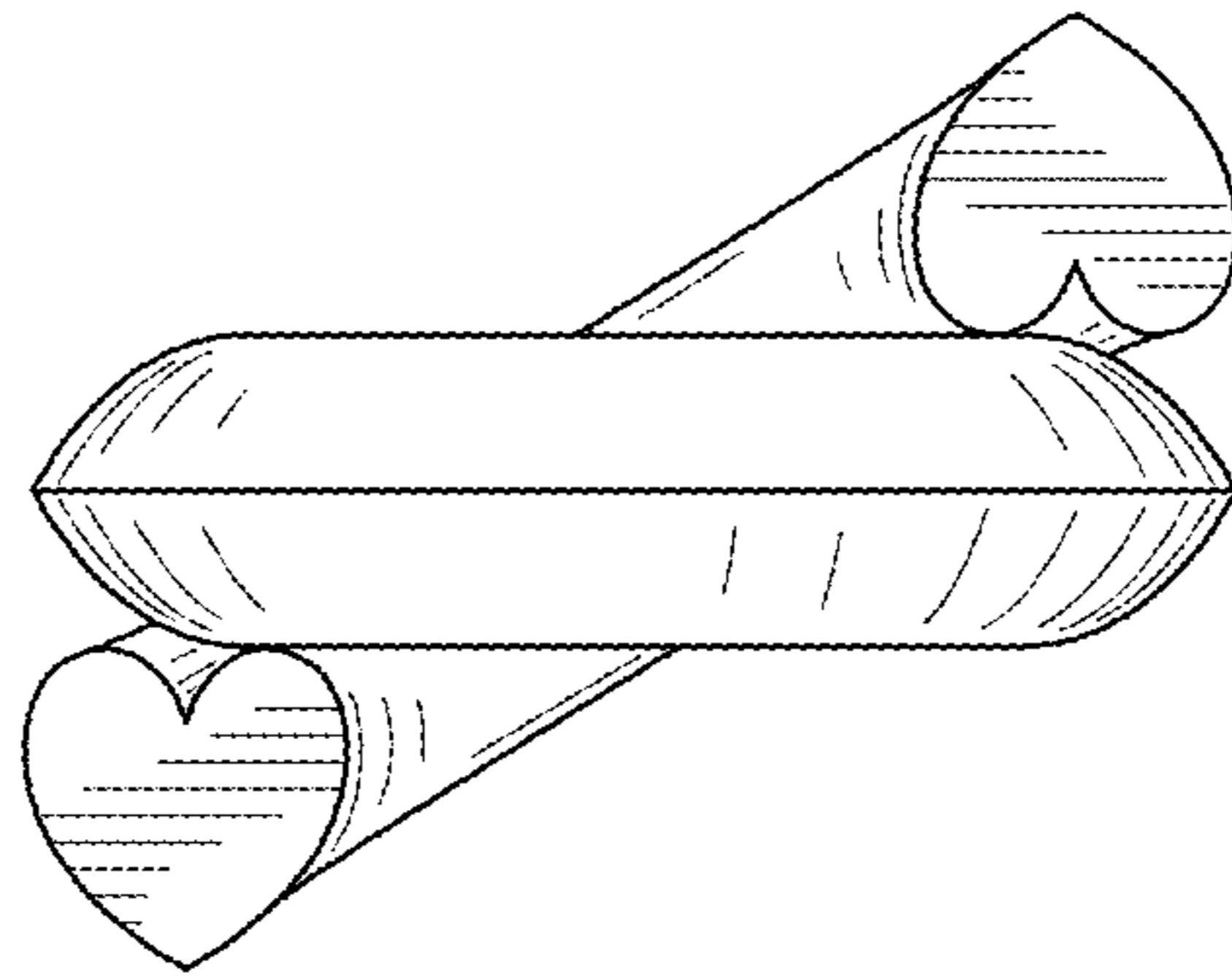

FIG. 16

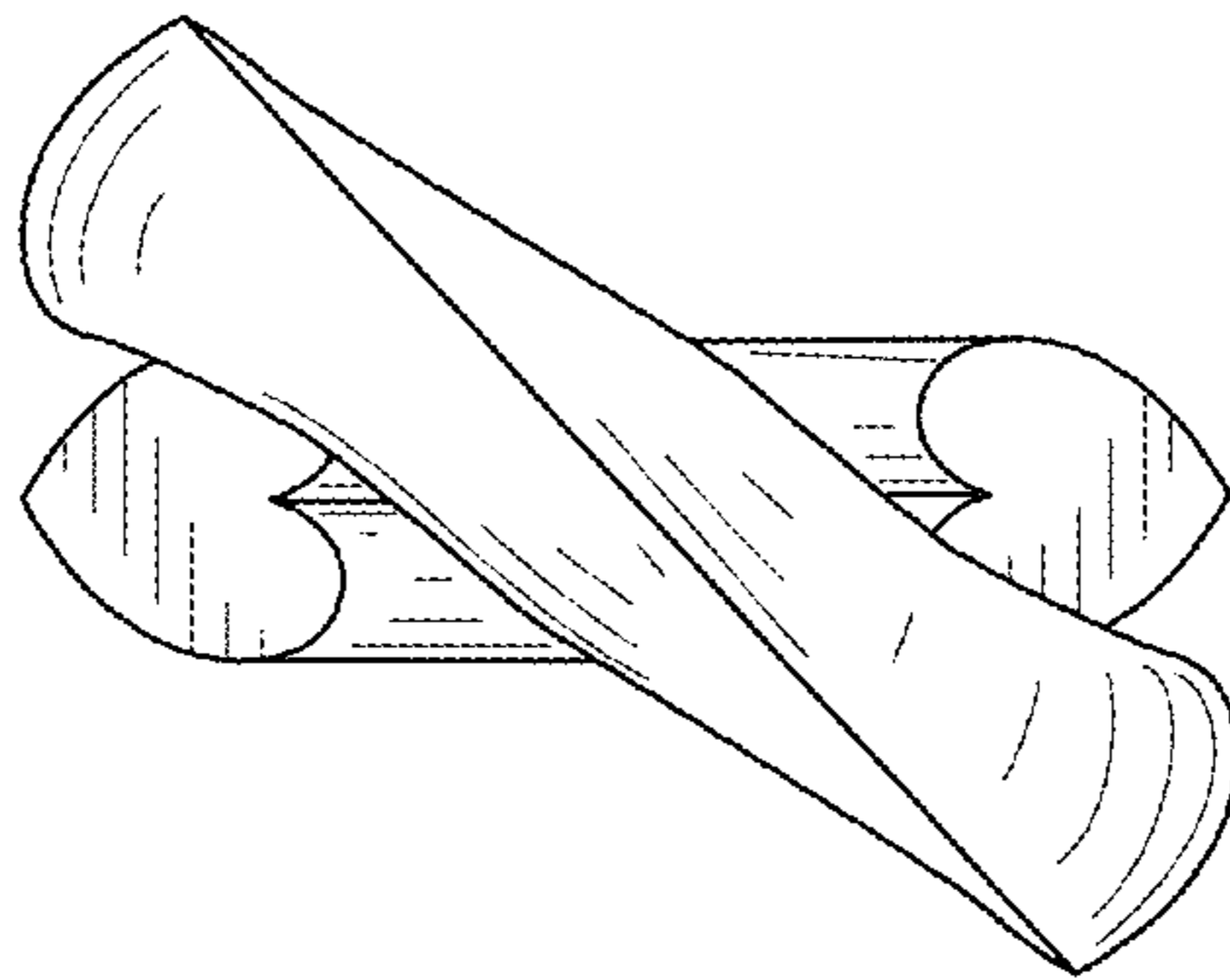

FIG. 17

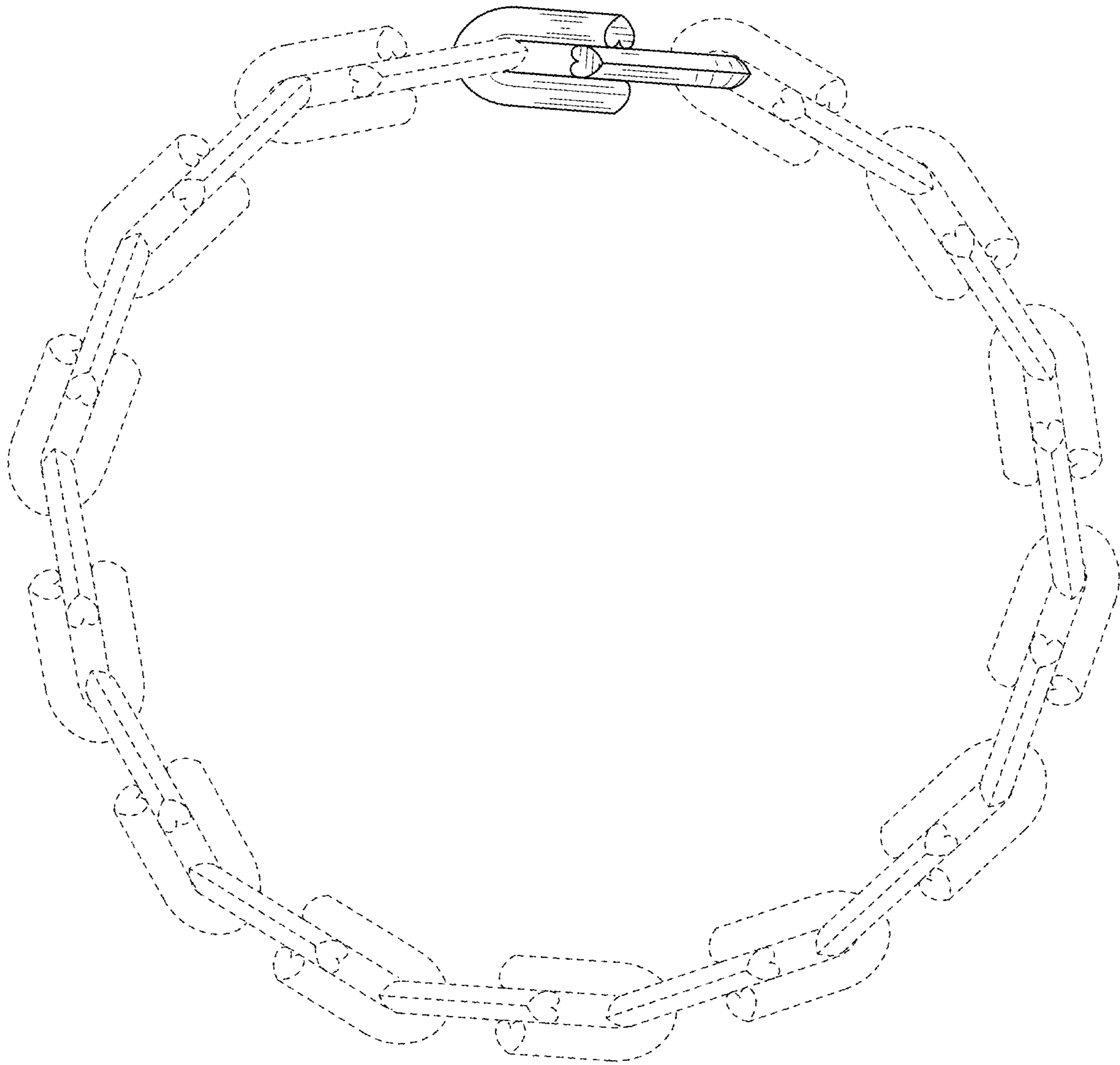

FIG. 18



FIG. 19

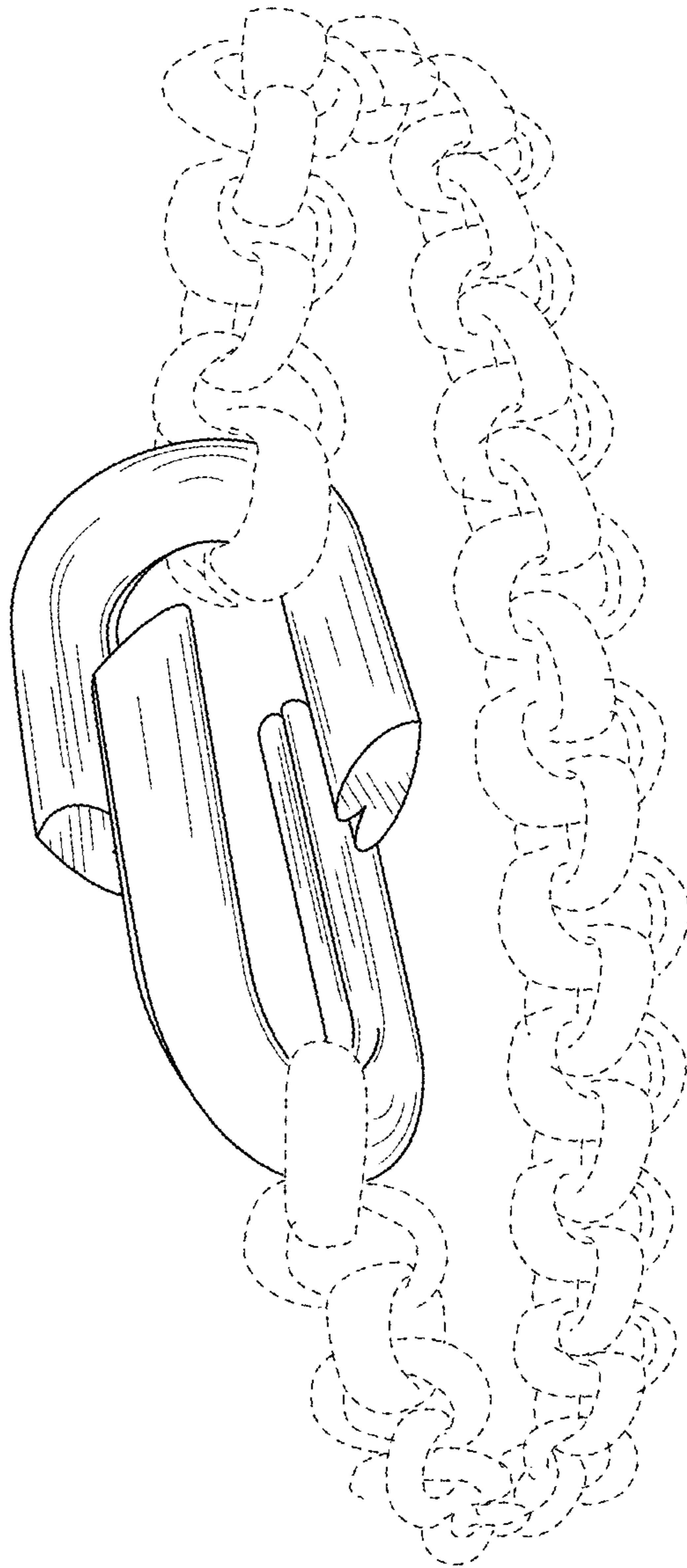

FIG. 20