



US00D983046S

(12) **United States Design Patent**
Butler

(10) **Patent No.:** **US D983,046 S**

(45) **Date of Patent:** **** Apr. 11, 2023**

(54) **BOTTLE**

(71) Applicant: **Monique Butler**, Murrieta, CA (US)

(72) Inventor: **Monique Butler**, Murrieta, CA (US)

(**) Term: **15 Years**

(21) Appl. No.: **29/837,287**

(22) Filed: **May 4, 2022**

(51) **LOC (14) Cl.** **09-01**

(52) **U.S. Cl.**

USPC **D9/652**; D9/530; D9/560; D24/197

(58) **Field of Classification Search**

USPC D9/682–694, 529, 560, 575, 500, 501,
D9/503, 504, 549, 558, 737–747, 652,
D9/600, 530, 542, 543, 562, 572–574;
D3/202, 270, 271.1–271.4; D24/197

CPC B05B 11/0038; B05B 11/0054; B65D
2543/00092

See application file for complete search history.

(56) **References Cited**

U.S. PATENT DOCUMENTS

D190,528 S *	6/1961	Brandeis	D9/543
D253,034 S *	10/1979	Meyer	D9/543
D335,453 S *	5/1993	Marti	D9/562
D339,295 S *	9/1993	Hicks	D9/549
D340,867 S *	11/1993	Martin	D9/530
D393,803 S *	4/1998	Walter	D9/543
D404,492 S *	1/1999	Demery	D24/197
D412,282 S *	7/1999	Cacciato	D9/530
D417,154 S *	11/1999	Weinert	D9/572
D461,416 S *	8/2002	Pieschel	D9/530
D465,412 S *	11/2002	Addis	D9/562
D483,874 S *	12/2003	Callier	D24/197
D516,920 S *	3/2006	Abadinsky	D9/542
D521,391 S *	5/2006	Andoh	D9/542
D559,108 S *	1/2008	Regas	D9/573

D581,800 S *	12/2008	Rica	D9/574
D595,141 S *	6/2009	Rica	D9/560
D603,717 S *	11/2009	Rica	D9/560
D604,175 S *	11/2009	Rica	D9/560
D684,065 S *	6/2013	Wiseman	D9/652
D716,152 S *	10/2014	Weiss	D9/745
D741,716 S *	10/2015	Konieczny	D9/562
D779,954 S *	2/2017	Ring	D9/560
D798,162 S *	9/2017	Hatellari	D9/652
D809,935 S *	2/2018	Weiss	D9/745
D860,802 S *	9/2019	Lee	D9/560
D896,098 S *	9/2020	Butler	D9/652
D908,507 S *	1/2021	Butler	D9/652
D908,508 S *	1/2021	Butler	D9/652
D922,203 S *	6/2021	De Silva Wijeyeratne	...	D9/562
D934,694 S *	11/2021	Heinonen	D9/560
D954,558 S *	6/2022	Butler	D9/652
D958,664 S *	7/2022	Lee	D9/560

* cited by examiner

Primary Examiner — Brett Miller

Assistant Examiner — Rani J Abdallah

(74) *Attorney, Agent, or Firm* — Clement Cheng

(57) **CLAIM**

The ornamental design for a bottle, as shown and described.

DESCRIPTION

FIG. 1 is a front perspective view of a transparent embodiment of a bottle incorporating the word GIRL.

FIG. 2 is a front view of the bottle shown in FIG. 1.

FIG. 3 is a rear view of the bottle shown in FIG. 1.

FIG. 4 is a left side view of the bottle shown in FIG. 1.

FIG. 5 is a right side view of the bottle shown in FIG. 1.

FIG. 6 is a top view of the bottle shown in FIG. 1; and,

FIG. 7 is a bottom view of the bottle shown in FIG. 1.

The dotted line disclosure for the cap of the bottle forms no part of the claimed invention.

1 Claim, 6 Drawing Sheets

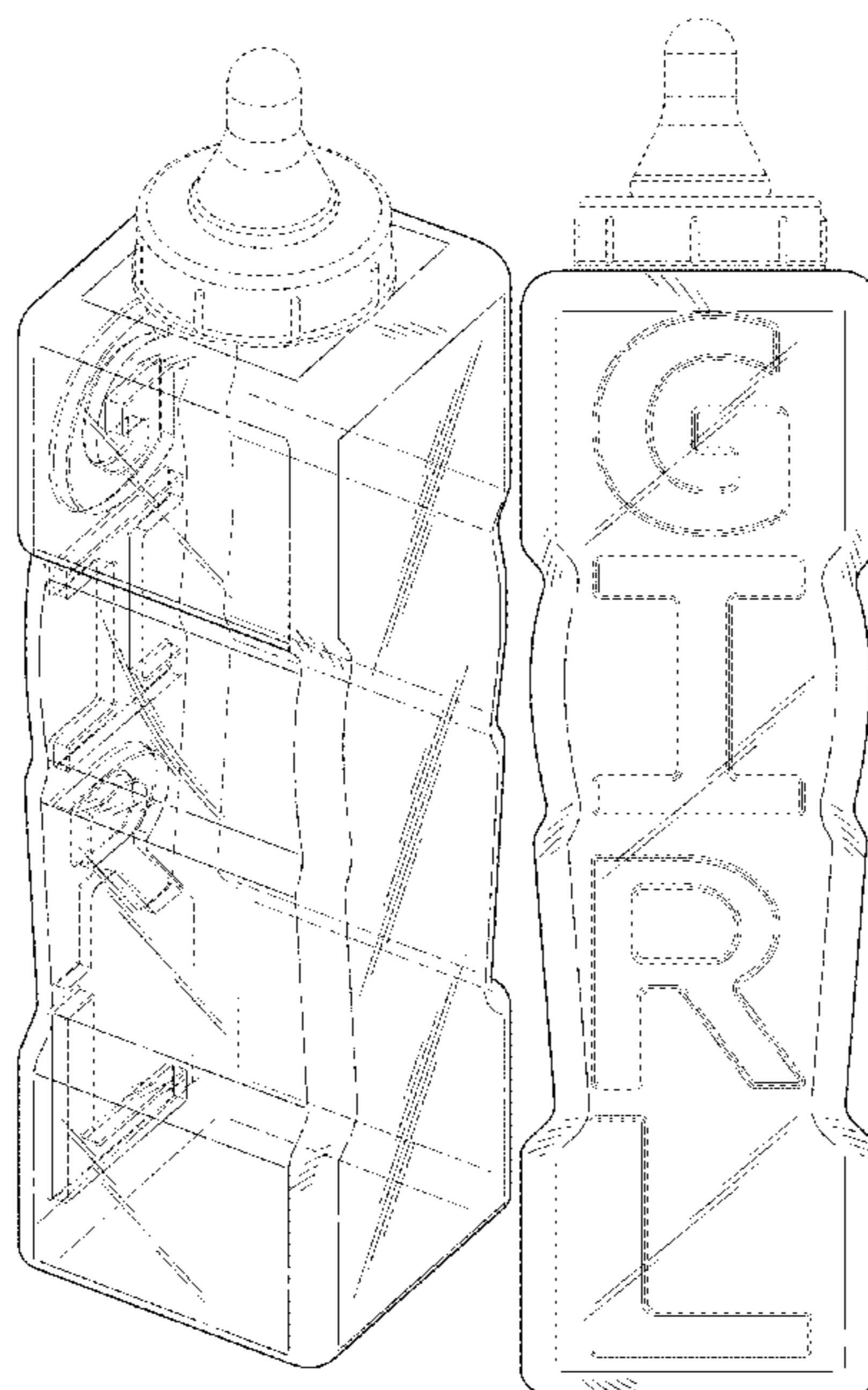

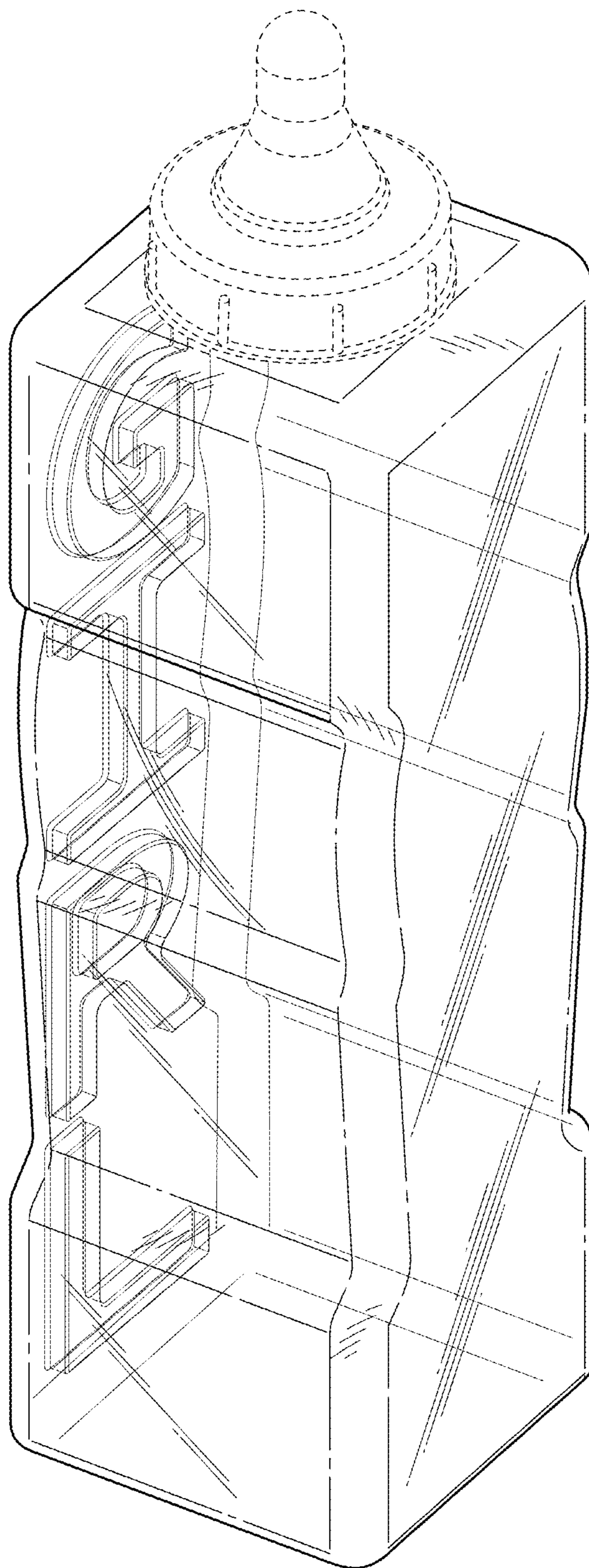

FIG. 1

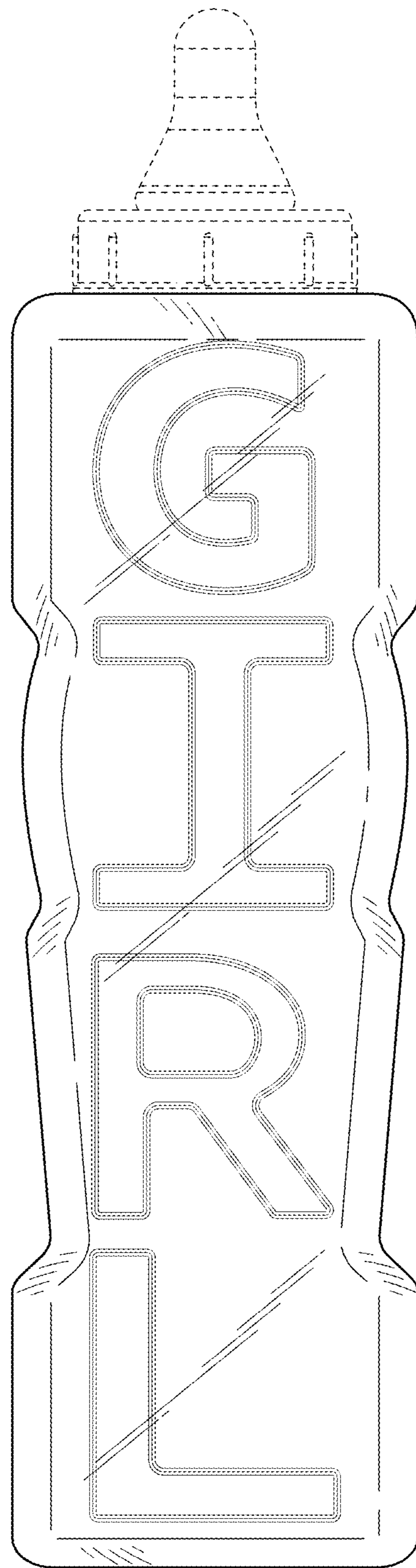

FIG. 2

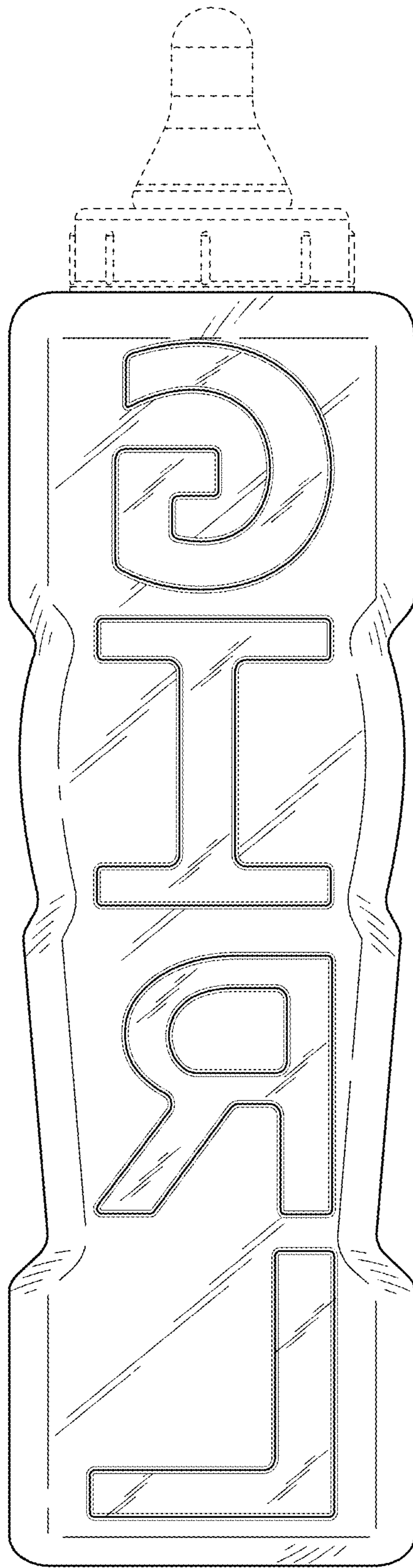

FIG. 3

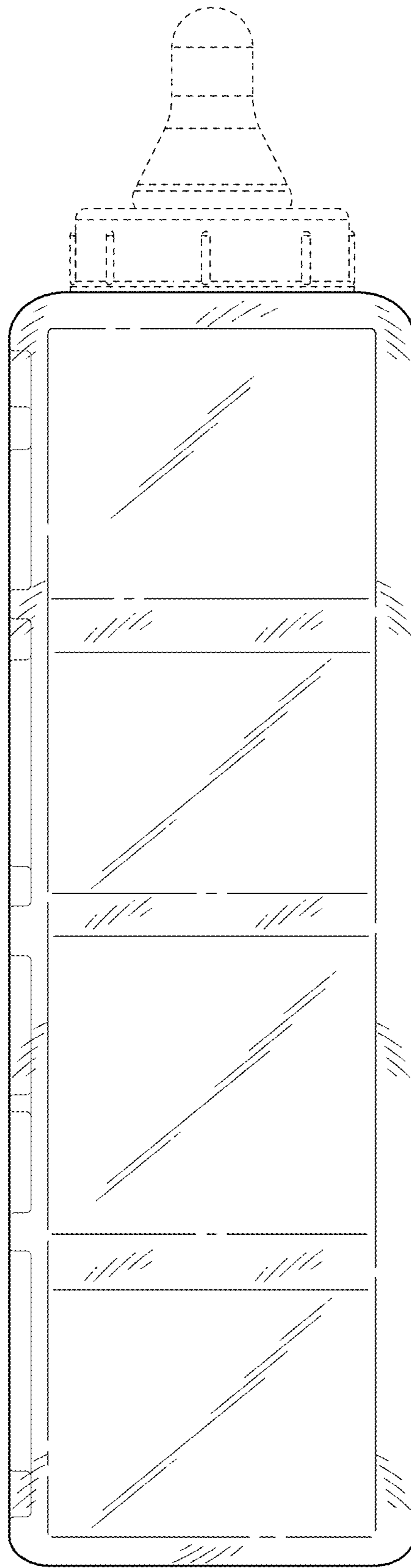

FIG. 4

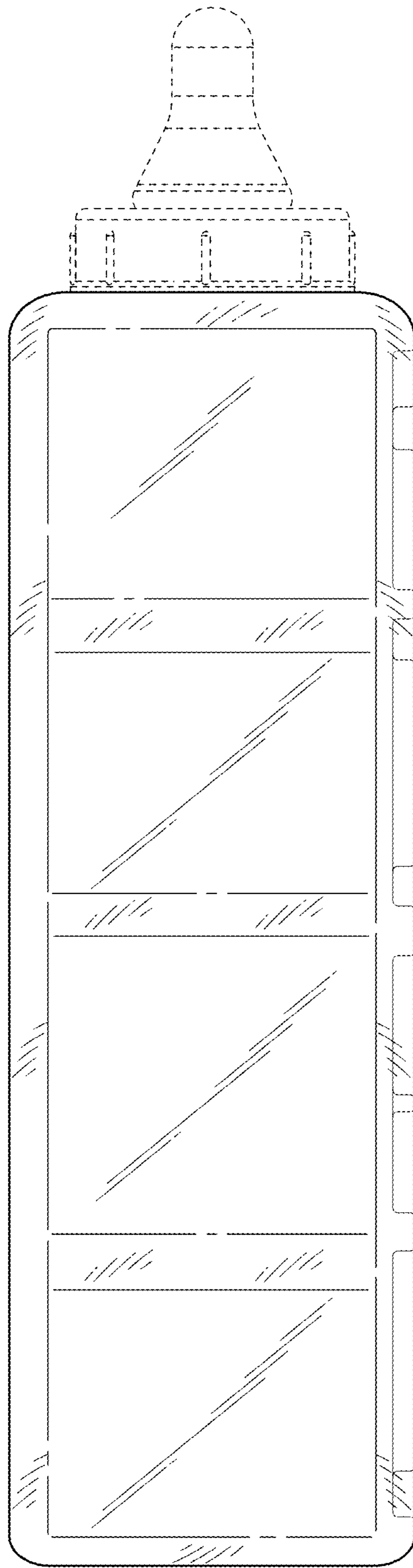

FIG. 5

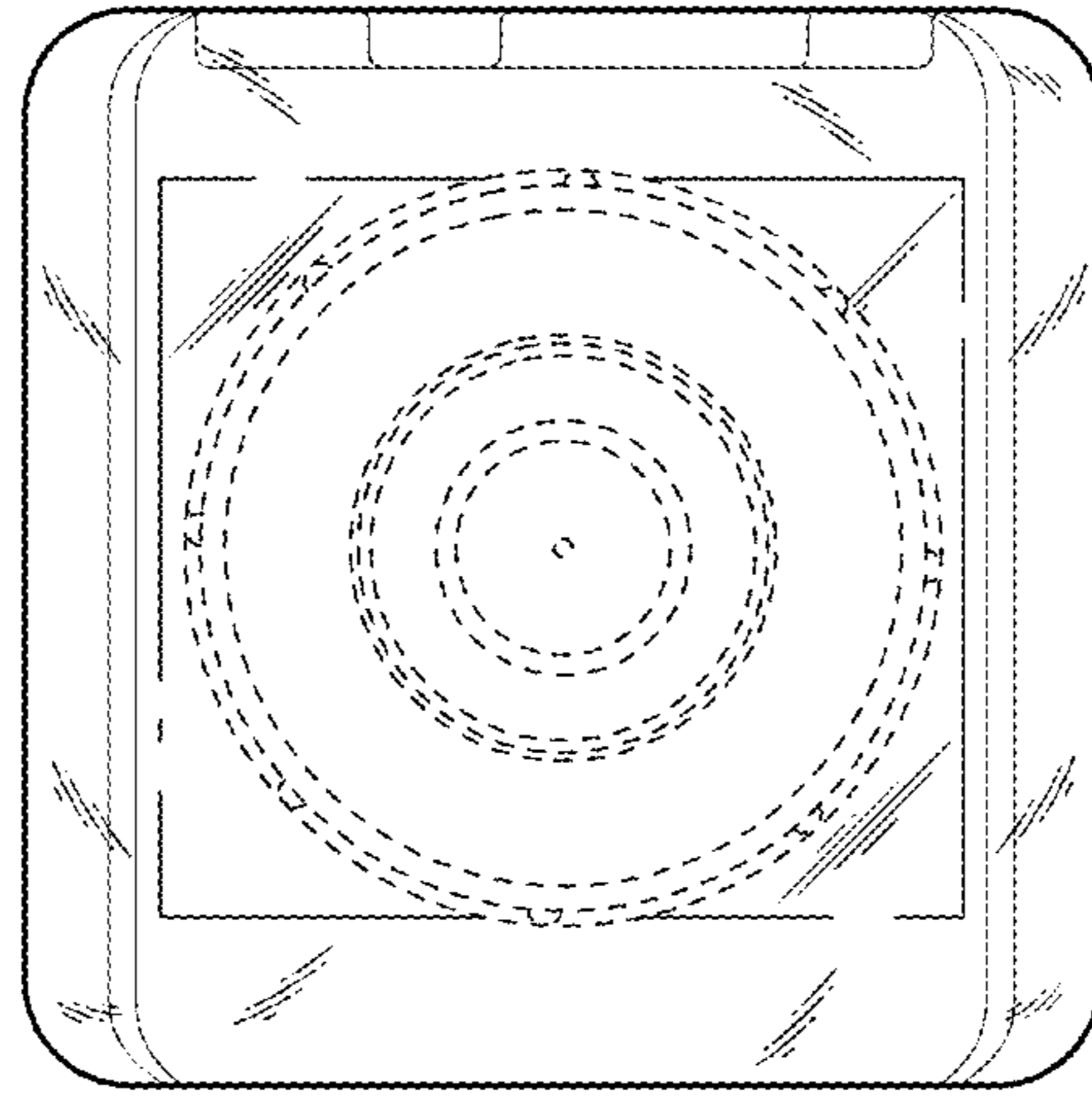

FIG. 6

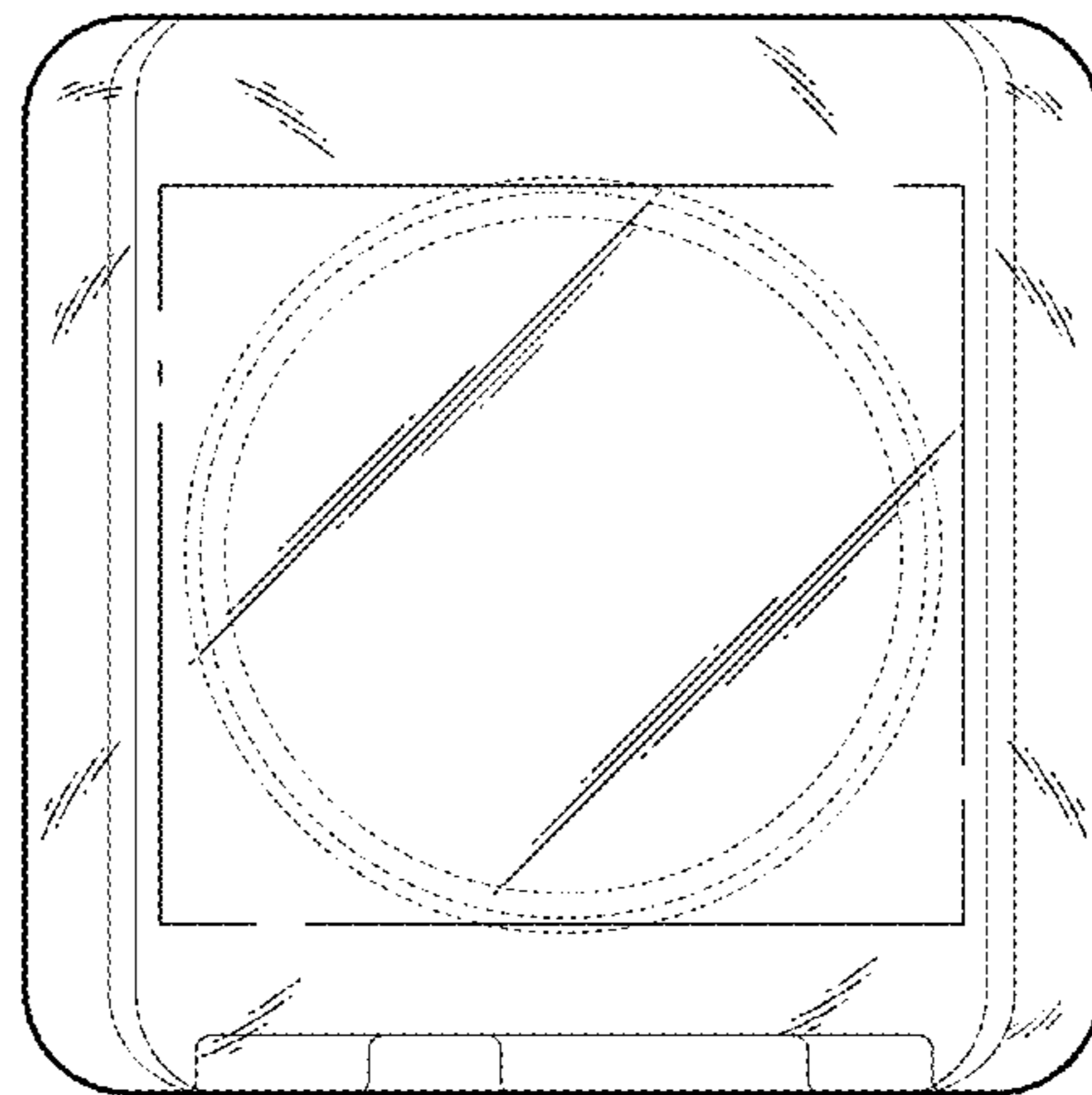

FIG. 7