



US00D983031S

(12) **United States Design Patent**  
**Shaw et al.**

(10) **Patent No.:** **US D983,031 S**  
(45) **Date of Patent:** **\*\* Apr. 11, 2023**

(54) **TOOTH-WHITENING PRODUCT CARTON**

**DESCRIPTION**

- (71) Applicant: **The Procter & Gamble Company**, Cincinnati, OH (US)
- (72) Inventors: **Jason Patrick Shaw**, Liberty Township, OH (US); **Martin Jay Marotti**, Carmel, IN (US)
- (73) Assignee: **The Procter & Gamble Company**, Cincinnati, OH (US)
- (\*\*) Term: **15 Years**
- (21) Appl. No.: **29/747,511**
- (22) Filed: **Aug. 24, 2020**
- (51) **LOC (14) Cl.** ..... **09-03**
- (52) **U.S. Cl.**  
USPC ..... **D9/418**
- (58) **Field of Classification Search**  
USPC ..... D9/414-427, 429-433, 455, 456, 499, D9/721

(Continued)

(56) **References Cited**

**U.S. PATENT DOCUMENTS**

- D249,932 S \* 10/1978 Russert ..... D9/417
- D406,754 S \* 3/1999 Tanabe ..... D9/415

(Continued)

**OTHER PUBLICATIONS**

Amazon. Crest Whitening Emulsions Teeth Whitening Treatment Kit. First available Jan. 1, 2015. Visited Dec. 28, 2021. <https://www.amazon.ca/Crest-Whitening-Emulsions-Teeth-Treatment/dp/B08HF4Z11M/> (Year: 2015).\*

*Primary Examiner* — Darcey E Gottschalk  
(74) *Attorney, Agent, or Firm* — Elizabeth A. Conklin

(57) **CLAIM**

The ornamental design for a tooth-whitening product carton, as shown and described.

The file of this patent contains at least one drawing/photograph executed in color. Copies of this patent with color drawing(s)/photograph(s) will be provided by the Office upon request and payment of the necessary fee.

FIG. 1 is a perspective view of a tooth-whitening product carton, embodying our new design containing a transparent window;

FIG. 2 is a front view thereof;

FIG. 3 is right side view thereof;

FIG. 4 is back side view thereof;

FIG. 5 is a left side view thereof;

FIG. 6 is a top side view thereof; and

FIG. 7 is a bottom side view thereof;

FIG. 8 is a perspective view of a second embodiment of a tooth-whitening product carton, embodying our new design containing a transparent window;

FIG. 9 is a front view thereof;

FIG. 10 is a right side view thereof;

FIG. 11 is a back side view thereof;

FIG. 12 is a left side view thereof;

FIG. 13 is a top side view thereof; and

FIG. 14 is a bottom side view thereof;

FIG. 15 is a perspective view of a third embodiment of a tooth-whitening product carton, embodying our new design containing a transparent window;

FIG. 16 is a front view thereof;

FIG. 17 is right side view thereof;

FIG. 18 is back side view thereof;

FIG. 19 is a left side view thereof;

FIG. 20 is a top side view thereof; and

FIG. 21 is a bottom side view thereof;

FIG. 22 is a perspective view of a fourth embodiment of a tooth-whitening product carton, embodying our new design containing a transparent window;

FIG. 23 is a front view thereof;

FIG. 24 is right side view thereof;

FIG. 25 is back side view thereof;

FIG. 26 is a left side view thereof;

FIG. 27 is a top side view thereof; and

FIG. 28 is a bottom side view thereof;

(Continued)

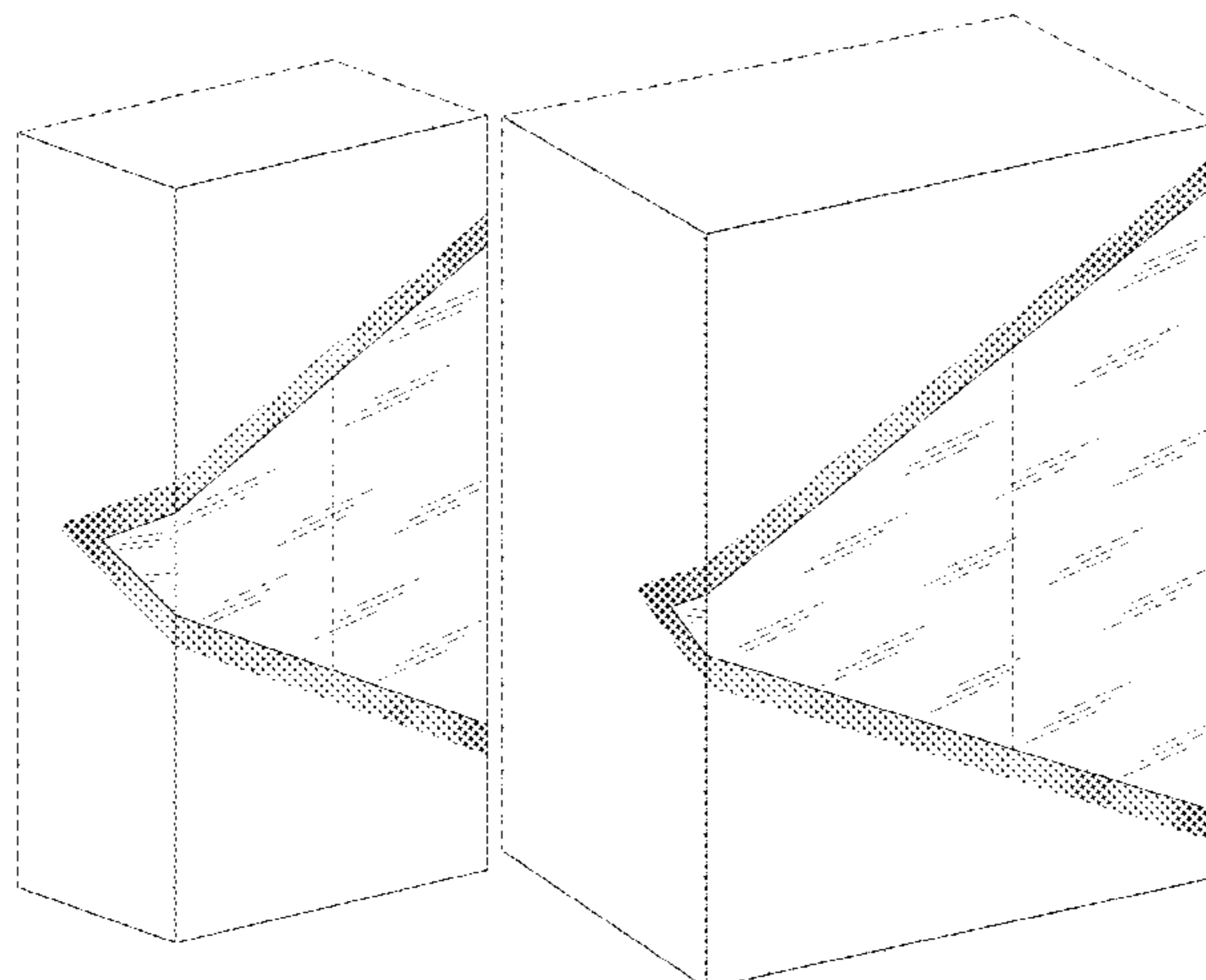

FIG. 29 is a perspective view of a fifth embodiment of a tooth-whitening product carton, embodying our new design containing a transparent window;  
 FIG. 30 is a front view thereof;  
 FIG. 31 is right side view thereof;  
 FIG. 32 is back side view thereof;  
 FIG. 33 is a left side view thereof;  
 FIG. 34 is a top side view thereof; and  
 FIG. 35 is a bottom side view thereof;  
 FIG. 36 is a perspective view of a sixth embodiment of a tooth-whitening product carton, embodying our new design containing a transparent window;  
 FIG. 37 is a front view thereof;  
 FIG. 38 is right side view thereof;  
 FIG. 39 is back side view thereof;  
 FIG. 40 is a left side view thereof;  
 FIG. 41 is a top side view thereof; and  
 FIG. 42 is a bottom side view thereof;  
 FIG. 43 is a perspective view of a seventh embodiment of a tooth-whitening product carton, embodying our new design containing a transparent window;  
 FIG. 44 is a front view thereof;  
 FIG. 45 is right side view thereof;  
 FIG. 46 is back side view thereof;  
 FIG. 47 is a left side view thereof;  
 FIG. 48 is a top side view thereof; and  
 FIG. 49 is a bottom side view thereof;  
 FIG. 50 is a perspective view of an eighth embodiment of a tooth-whitening product carton, embodying our new design containing a transparent window;  
 FIG. 51 is a front view thereof;  
 FIG. 52 is right side view thereof;  
 FIG. 53 is back side view thereof;  
 FIG. 54 is a left side view thereof;  
 FIG. 55 is a top side view thereof; and  
 FIG. 56 is a bottom side view thereof;  
 FIG. 57 is a perspective view of a ninth embodiment of a tooth-whitening product carton, embodying our new design containing a transparent window;  
 FIG. 58 is a front view thereof;  
 FIG. 59 is right side view thereof;  
 FIG. 60 is back side view thereof;  
 FIG. 61 is a left side view thereof;  
 FIG. 62 is a top side view thereof; and  
 FIG. 63 is a bottom side view thereof;  
 FIG. 64 is a perspective view of a tenth embodiment of a tooth-whitening product carton, embodying our new design containing a transparent window;  
 FIG. 65 is a front view thereof;  
 FIG. 66 is right side view thereof;  
 FIG. 67 is back side view thereof;  
 FIG. 68 is a left side view thereof;  
 FIG. 69 is a top side view thereof; and  
 FIG. 70 is a bottom side view thereof;  
 FIG. 71 is a perspective view of an eleventh embodiment of a tooth-whitening product carton, embodying our new design containing a transparent window;  
 FIG. 72 is a front view thereof;  
 FIG. 73 is right side view thereof;  
 FIG. 74 is back side view thereof;  
 FIG. 75 is a left side view thereof;  
 FIG. 76 is a top side view thereof; and

FIG. 77 is a bottom side view thereof;  
 FIG. 78 is a perspective view of a twelfth embodiment of a tooth-whitening product carton, embodying our new design containing a transparent window;  
 FIG. 79 is a front view thereof;  
 FIG. 80 is right side view thereof;  
 FIG. 81 is back side view thereof;  
 FIG. 82 is a left side view thereof;  
 FIG. 83 is a top side view thereof; and,  
 FIG. 84 is a bottom side view thereof.  
 In the drawings, the broken lines show portions of a tooth-whitening product carton that form no part of the claim.  
 The gray shading illustrates color contrast, not surface ornamentation or a particular color.

**1 Claim, 60 Drawing Sheets  
 (18 of 60 Drawing Sheet(s) Filed in Color)**

(58) **Field of Classification Search**  
 CPC ..... B65D 5/42; B65D 5/50  
 See application file for complete search history.

(56) **References Cited**

U.S. PATENT DOCUMENTS

D466,804	S	*	12/2002	Solland	.....	D9/418
D528,906	S	*	9/2006	Harper	.....	D9/418
D542,647	S	*	5/2007	Walter	.....	D9/414
D600,110	S	*	9/2009	Cain	.....	D9/418
D600,547	S	*	9/2009	Cain	.....	D9/418
D625,179	S	*	10/2010	Gibson	.....	D9/423
D633,786	S	*	3/2011	Gibson	.....	D9/423
D636,663	S	*	4/2011	Work	.....	D9/418
D639,652	S	*	6/2011	Abdalkhani	.....	D9/418
D649,067	S	*	11/2011	Birdwell	.....	D9/721
D693,212	S	*	11/2013	Lee	.....	D9/415
D699,563	S	*	2/2014	McAdam	.....	D9/418
D702,546	S	*	4/2014	McAdam	.....	D9/418
D739,242	S	*	9/2015	Pitera	.....	D9/499
D740,118	S	*	10/2015	Kawai	.....	D9/499
D740,654	S	*	10/2015	Boehnen	.....	D9/418
D743,248	S	*	11/2015	Fath	.....	D9/418
D769,121	S	*	10/2016	Mochizuki	.....	D9/499
D779,327	S	*	2/2017	Fraser	.....	D9/499
D798,141	S	*	9/2017	Miller	.....	D9/418
D822,480	S	*	7/2018	Rivera	.....	D9/418
D833,868	S	*	11/2018	Marotti	.....	D9/434
D846,383	S	*	4/2019	Hernandez	.....	D9/434
D863,950	S	*	10/2019	Chilton	.....	D9/418
D866,313	S	*	11/2019	Marotti	.....	D9/418
D866,314	S	*	11/2019	Marotti	.....	D9/418
D870,551	S	*	12/2019	Klesmith	.....	D9/418
D891,917	S	*	8/2020	Candan	.....	D9/418
D907,478	S	*	1/2021	Marotti	.....	D9/418
D907,479	S	*	1/2021	Marotti	.....	D9/418
D918,056	S	*	5/2021	Garrison	.....	D9/734
D921,480	S	*	6/2021	Marotti	.....	D9/418
D924,049	S	*	7/2021	Carr	.....	D9/418
D924,050	S	*	7/2021	Carr	.....	D9/418
D939,340	S	*	12/2021	Moffat	.....	D9/414
D952,456	S	*	5/2022	Creager	.....	D9/418
2013/0299372	A1	*	11/2013	Ha	.....	B65D 77/042 206/362.1
2020/0216216	A1	*	7/2020	Marotti	.....	B65D 5/4204
2021/0229858	A1	*	7/2021	Martinsen	.....	B65D 5/001

\* cited by examiner

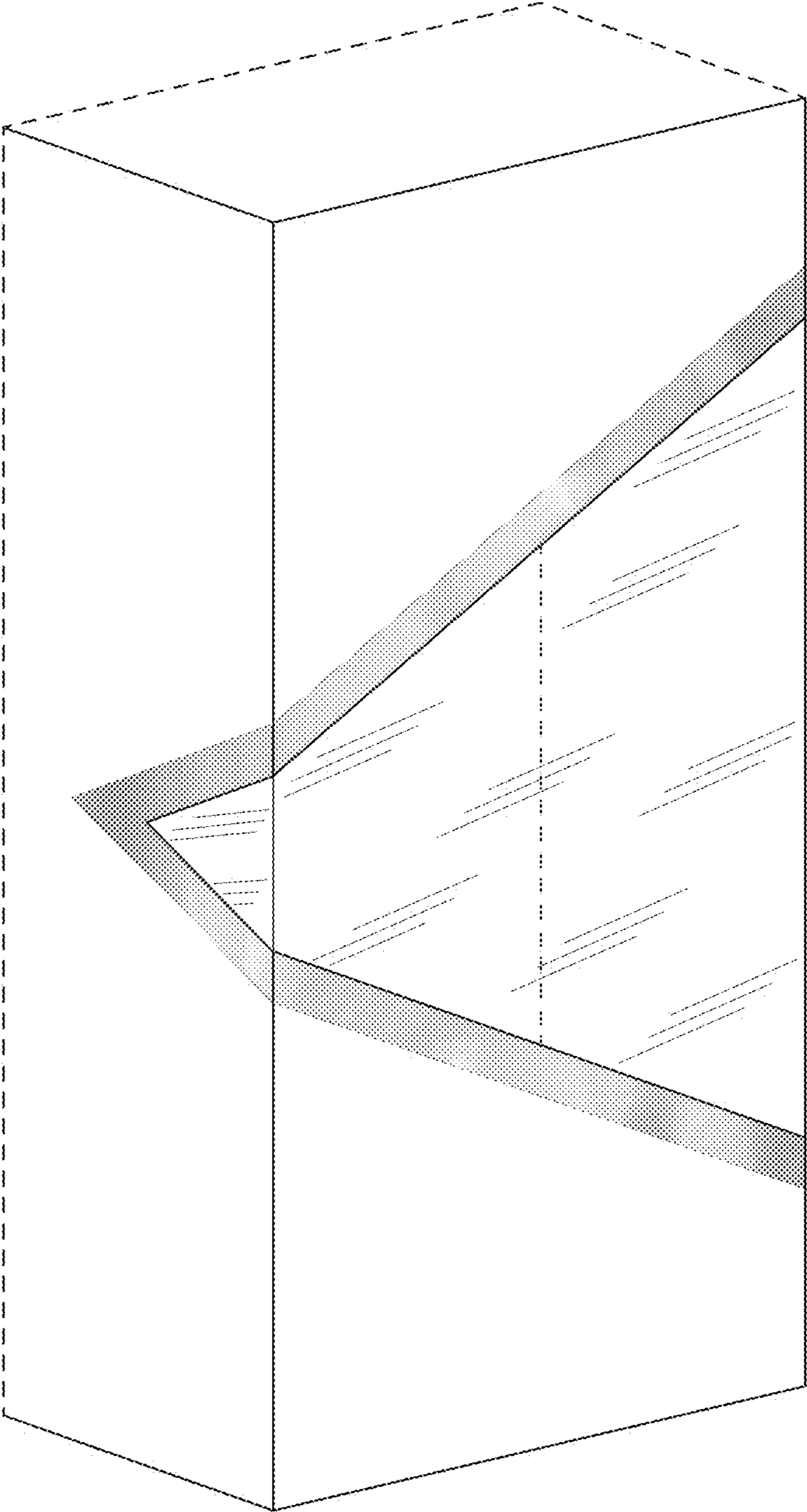

FIG. 1

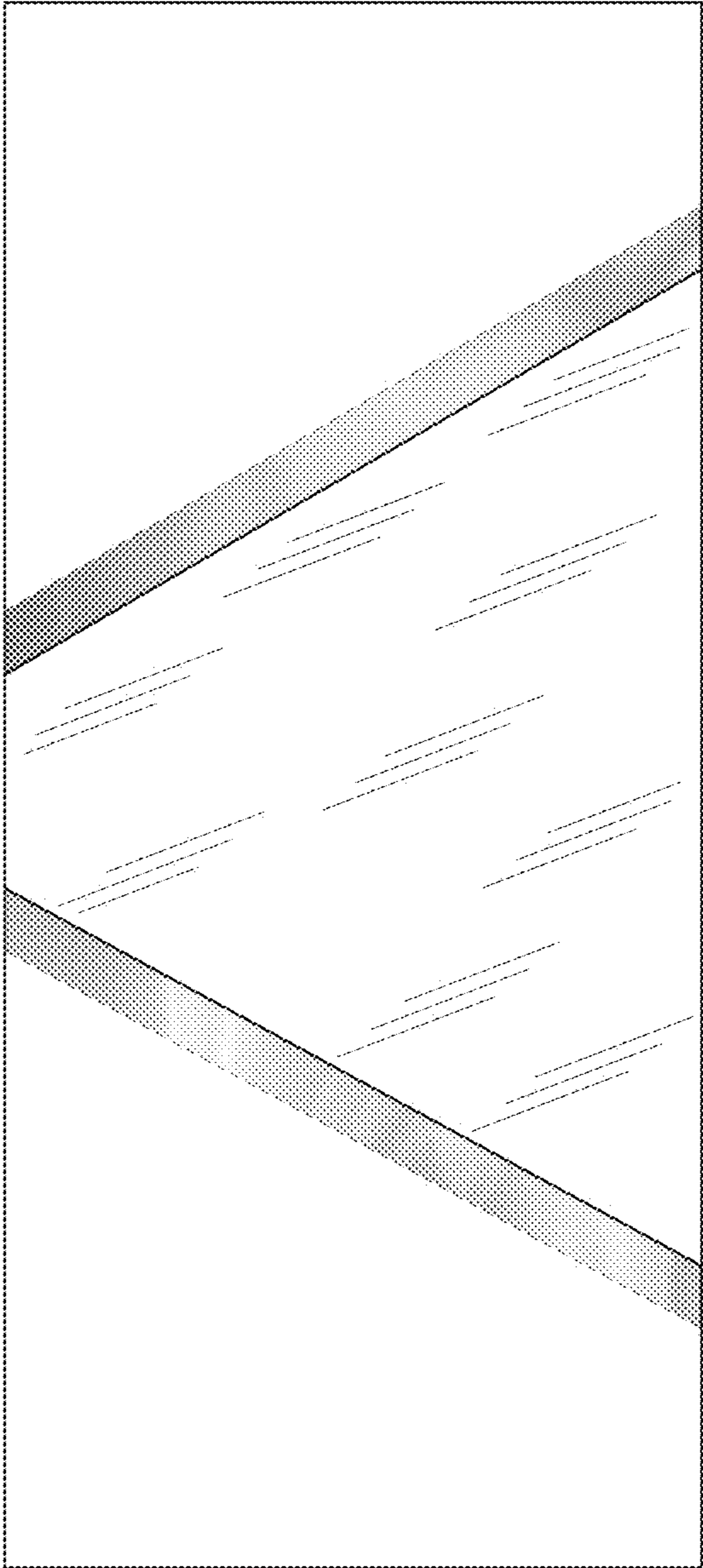

FIG. 2

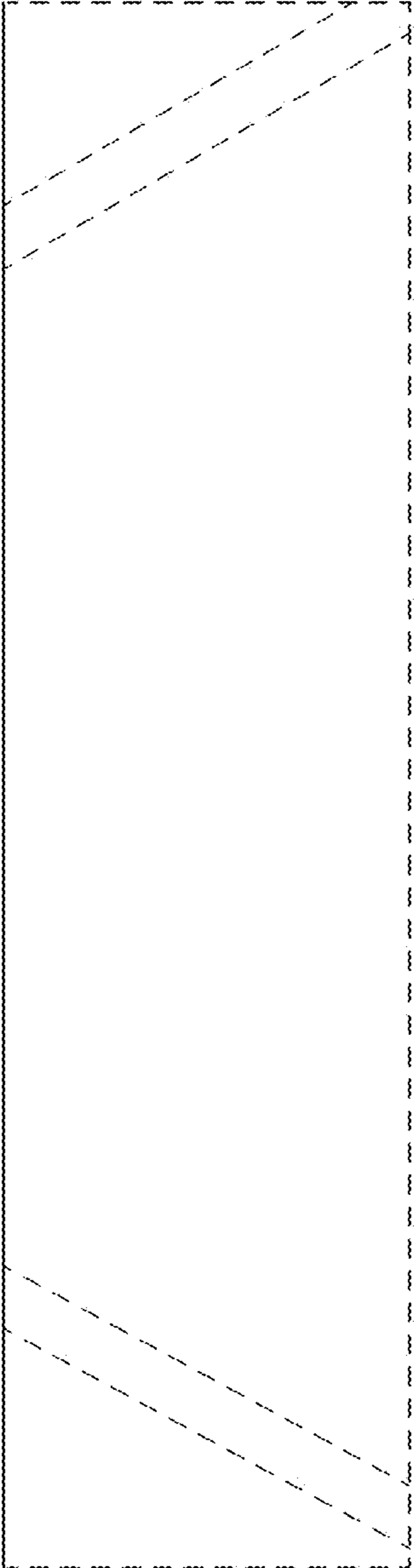

FIG. 3

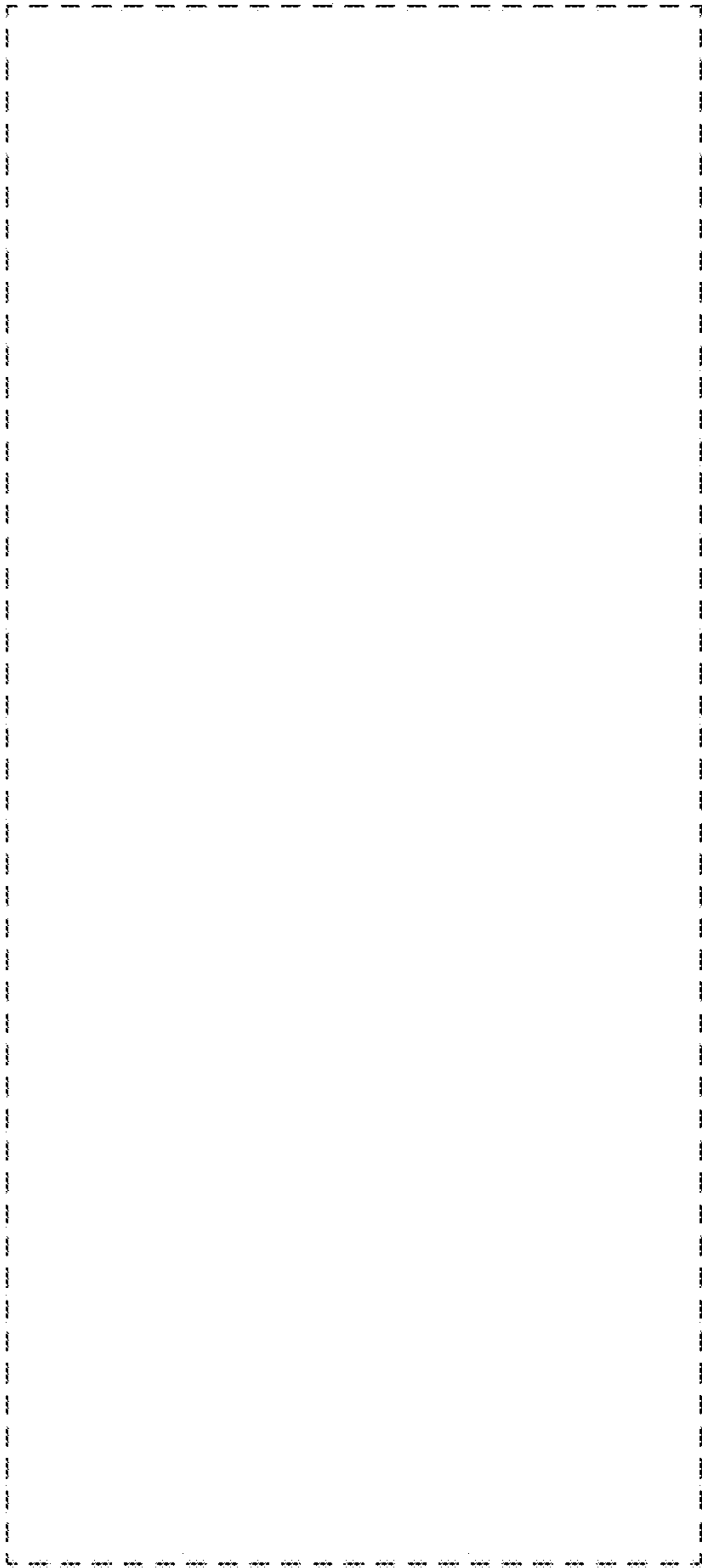

FIG. 4

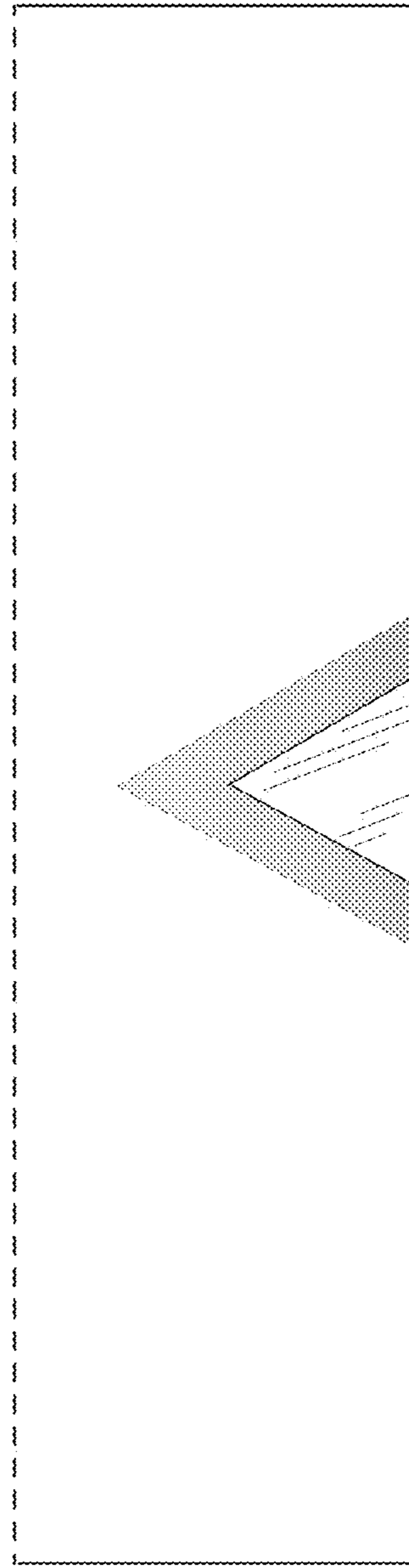

FIG. 5

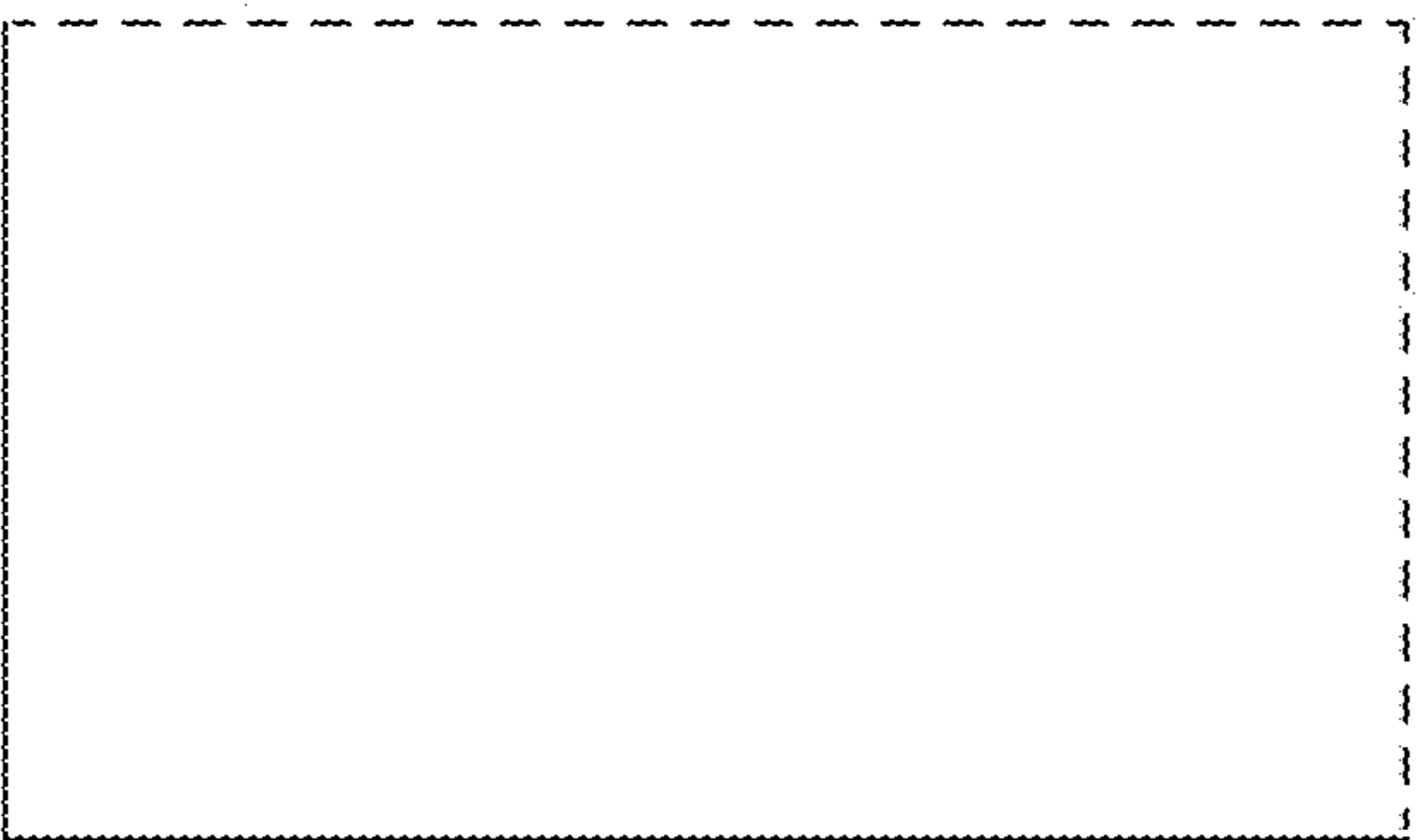

FIG. 6

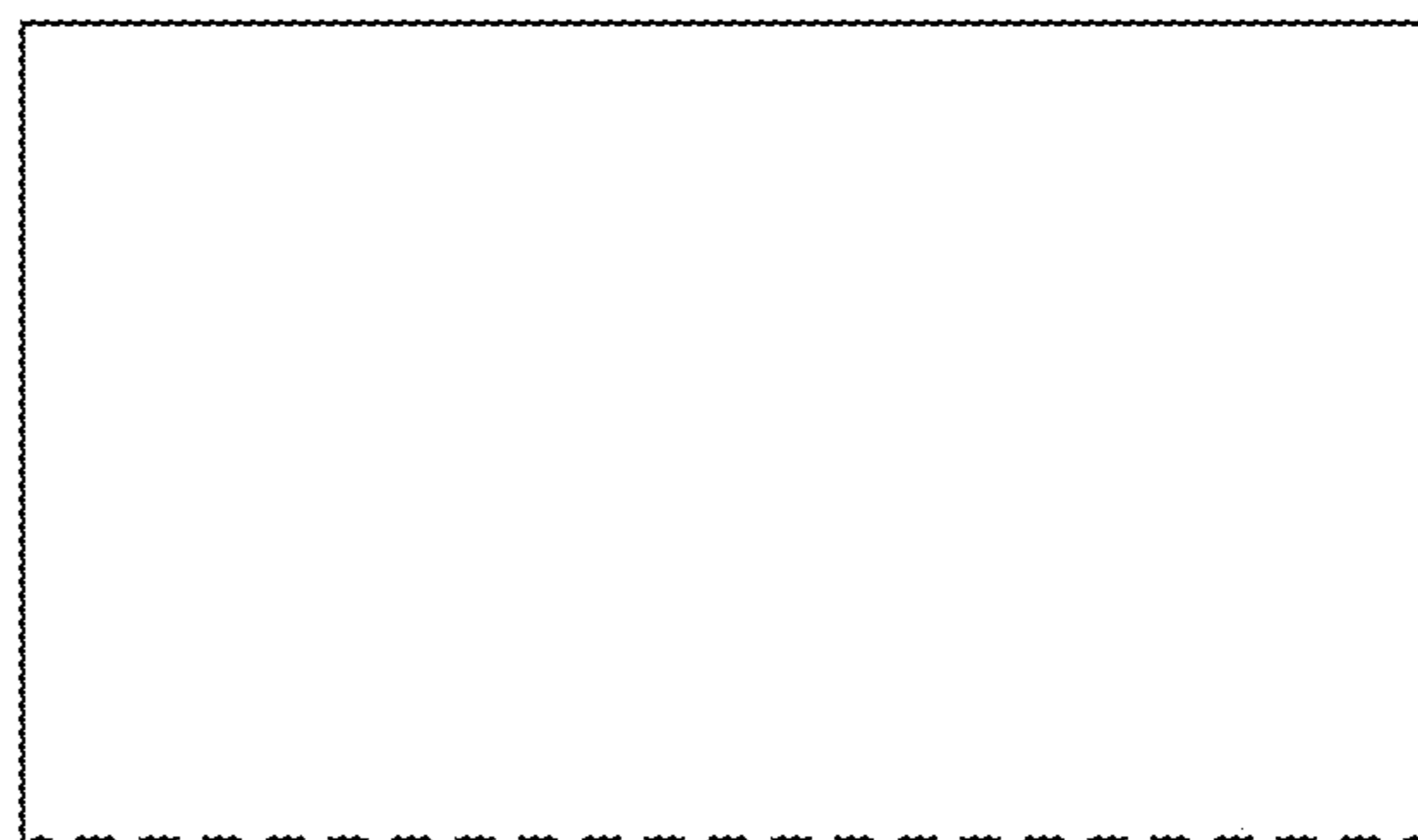

FIG. 7

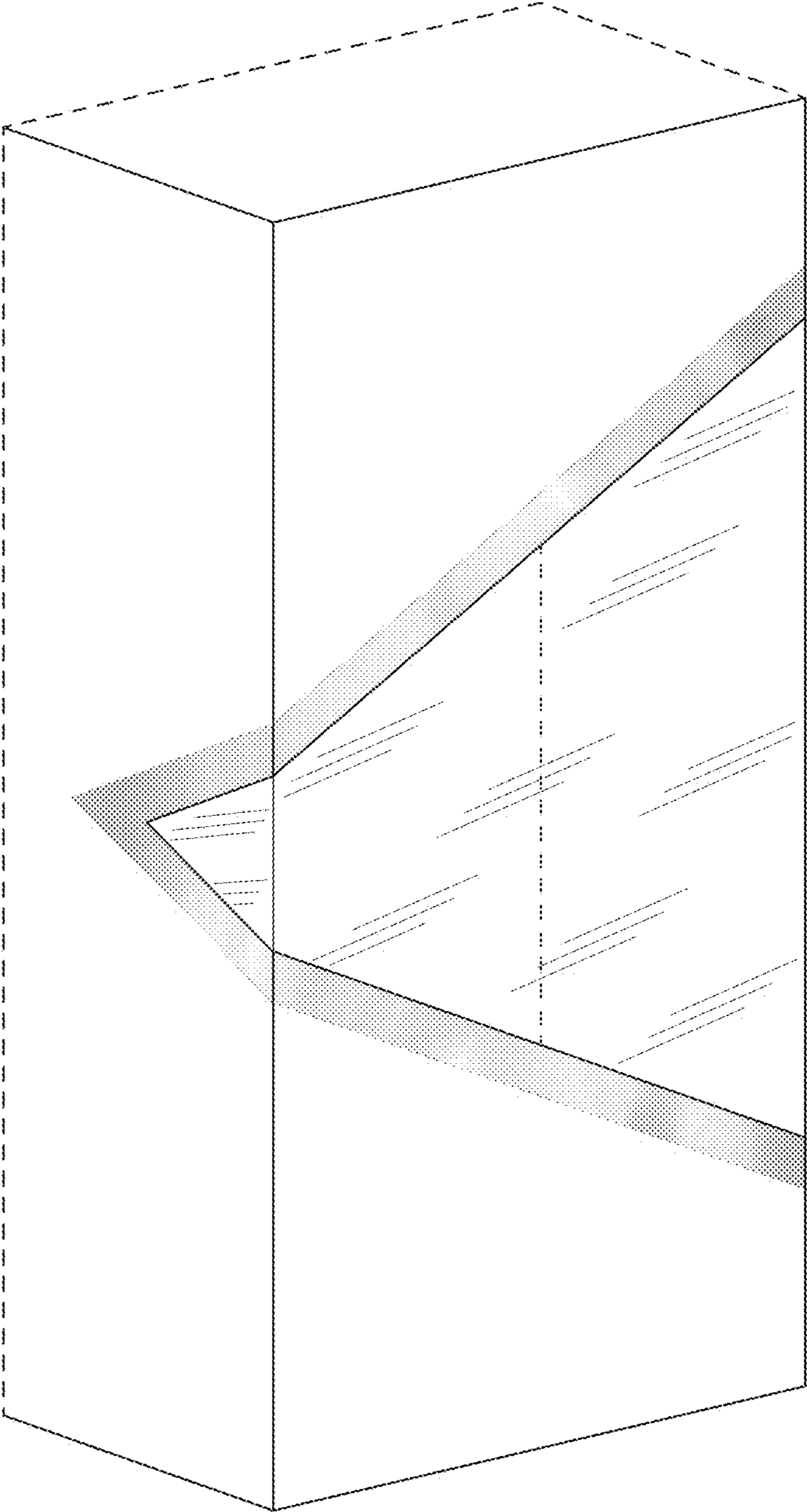

FIG. 8

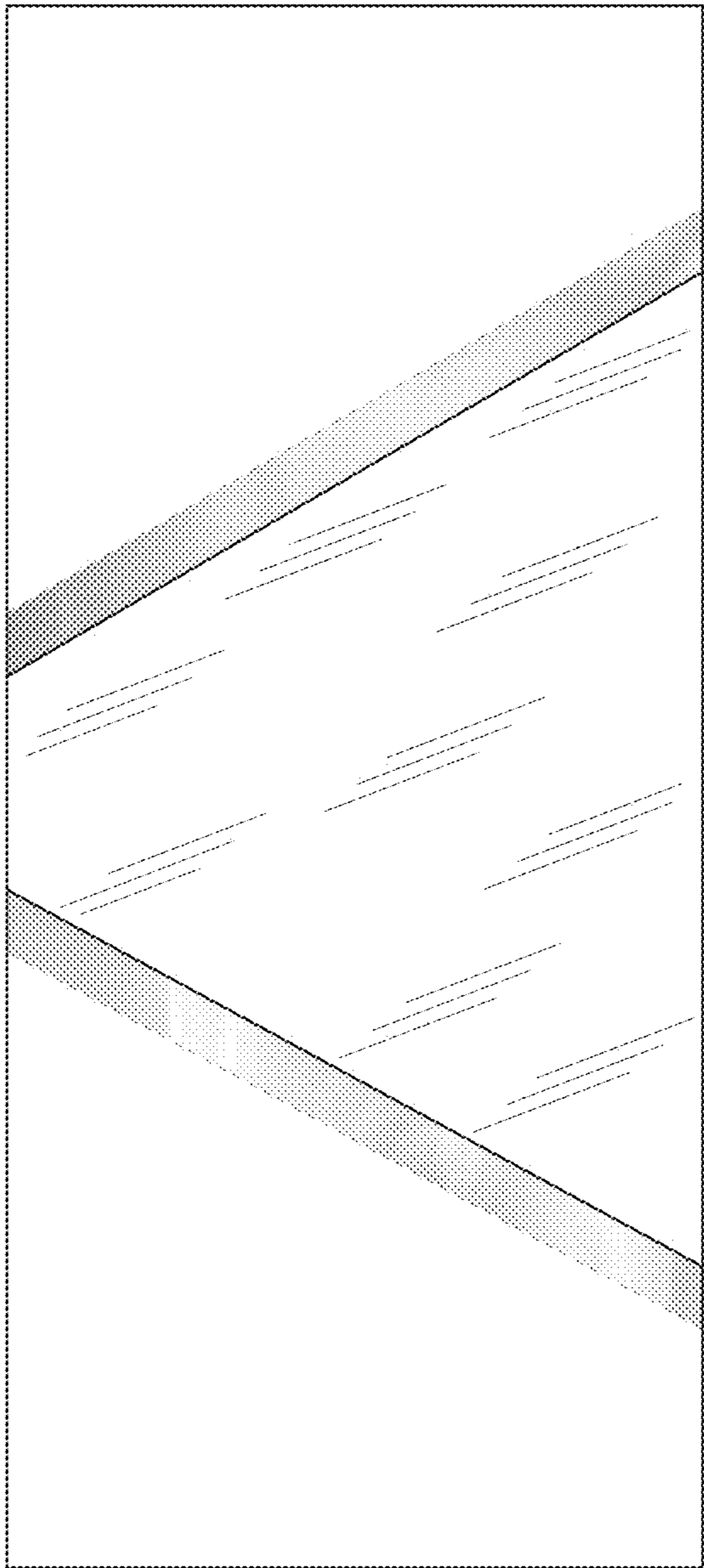

FIG. 9

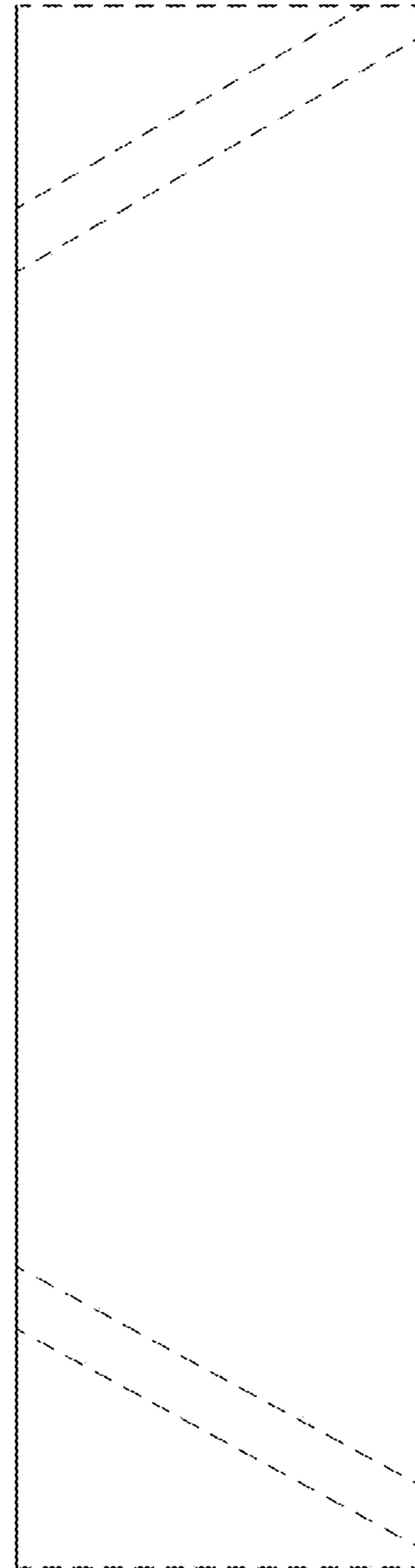

FIG. 10

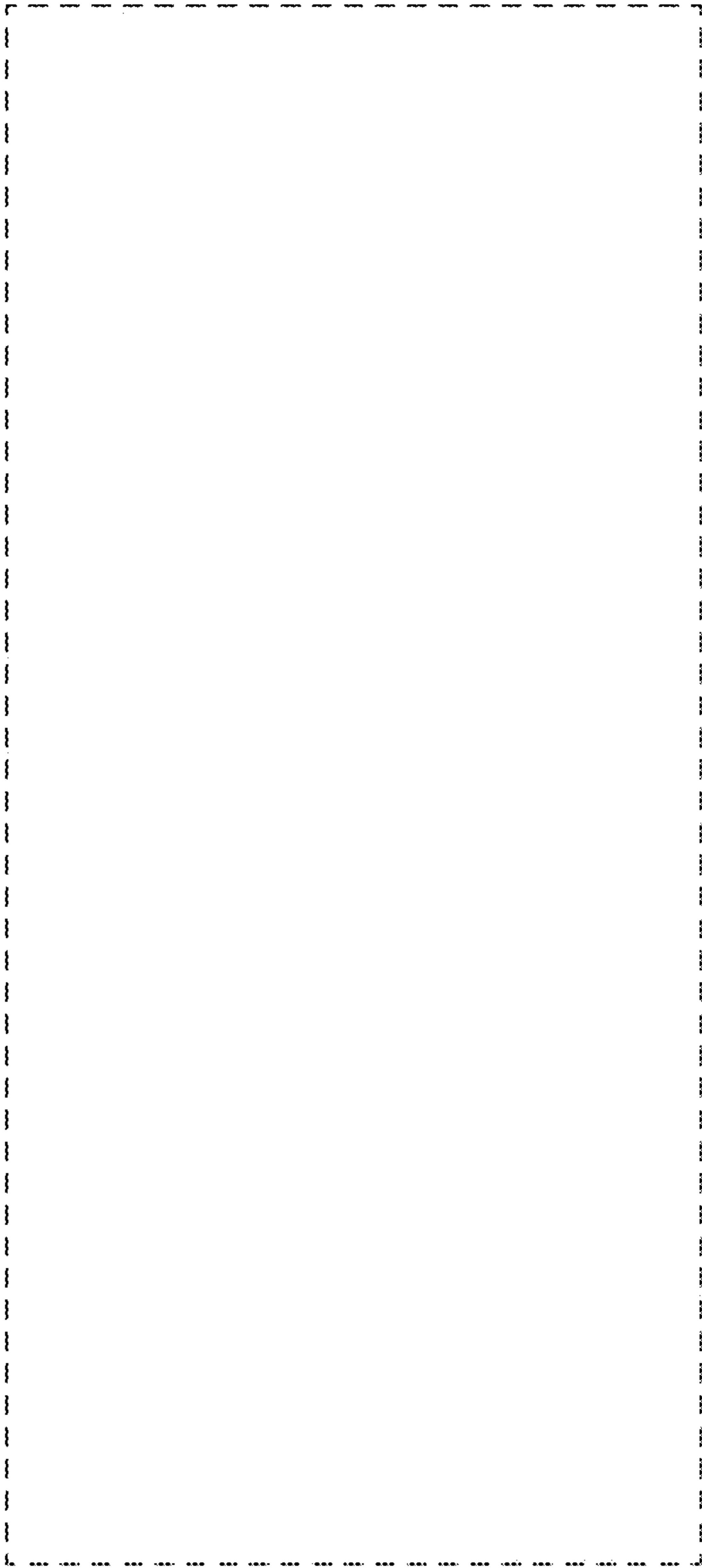

FIG. 11

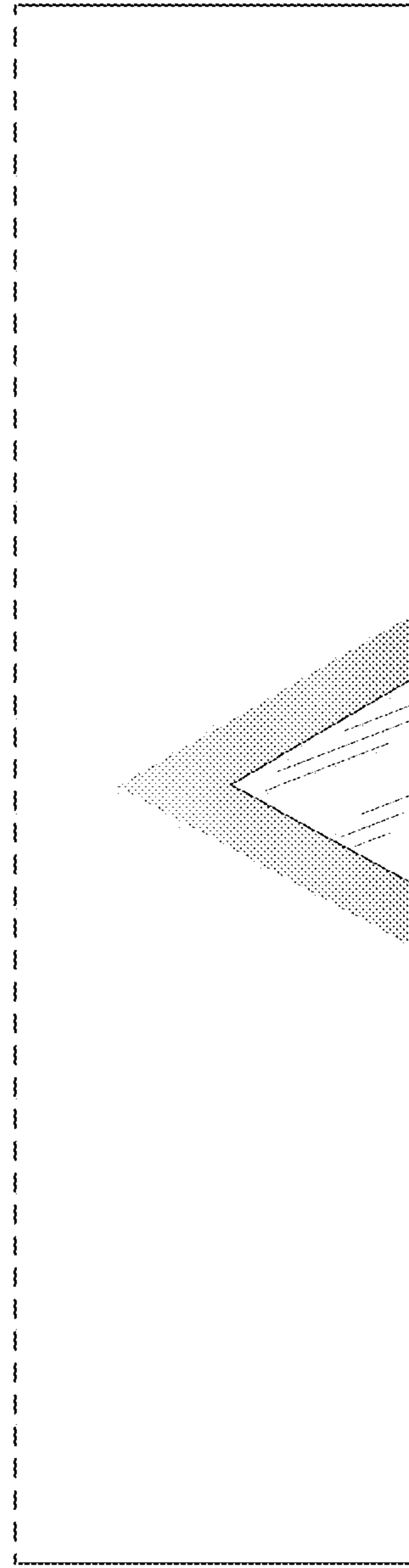

FIG. 12

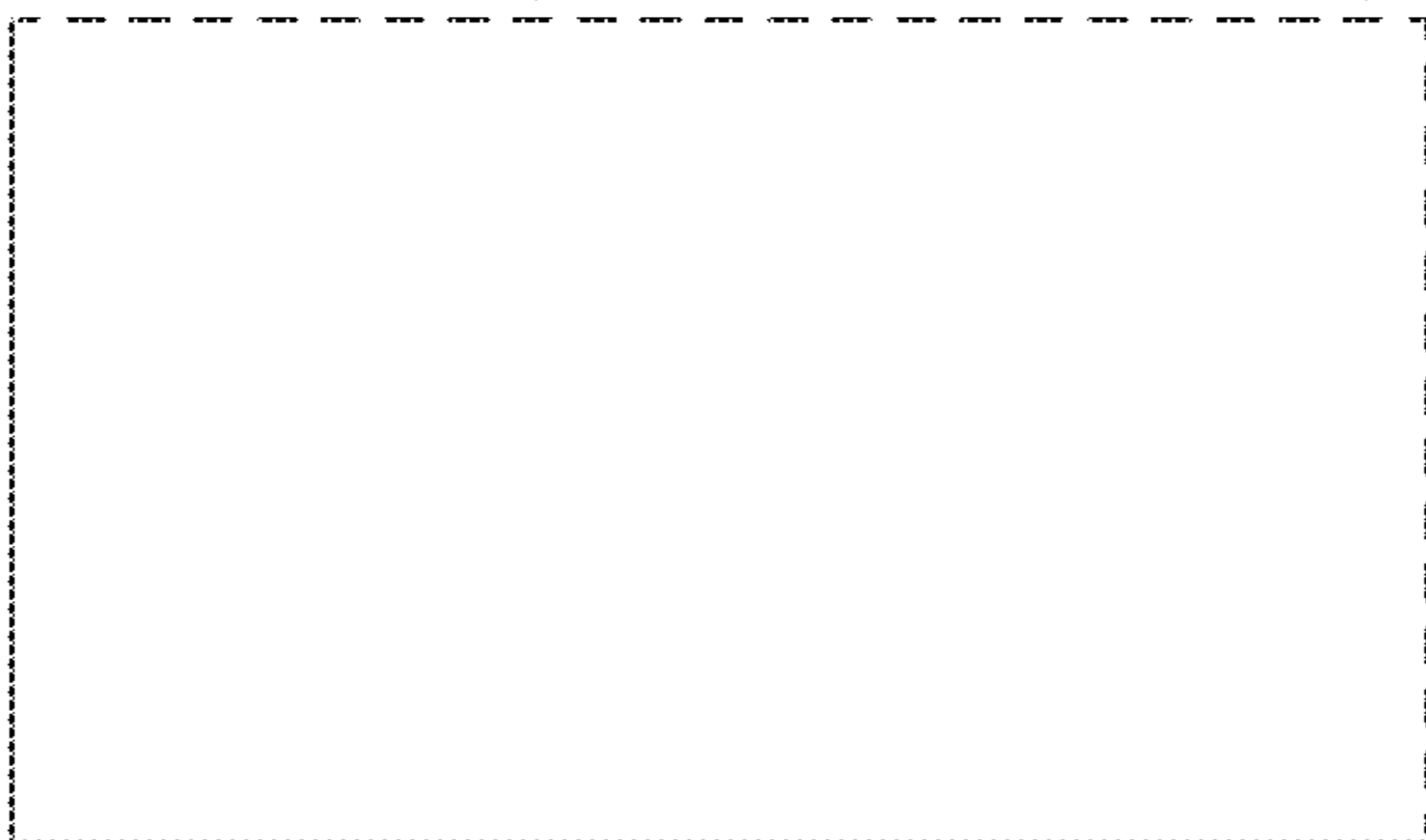

FIG. 13

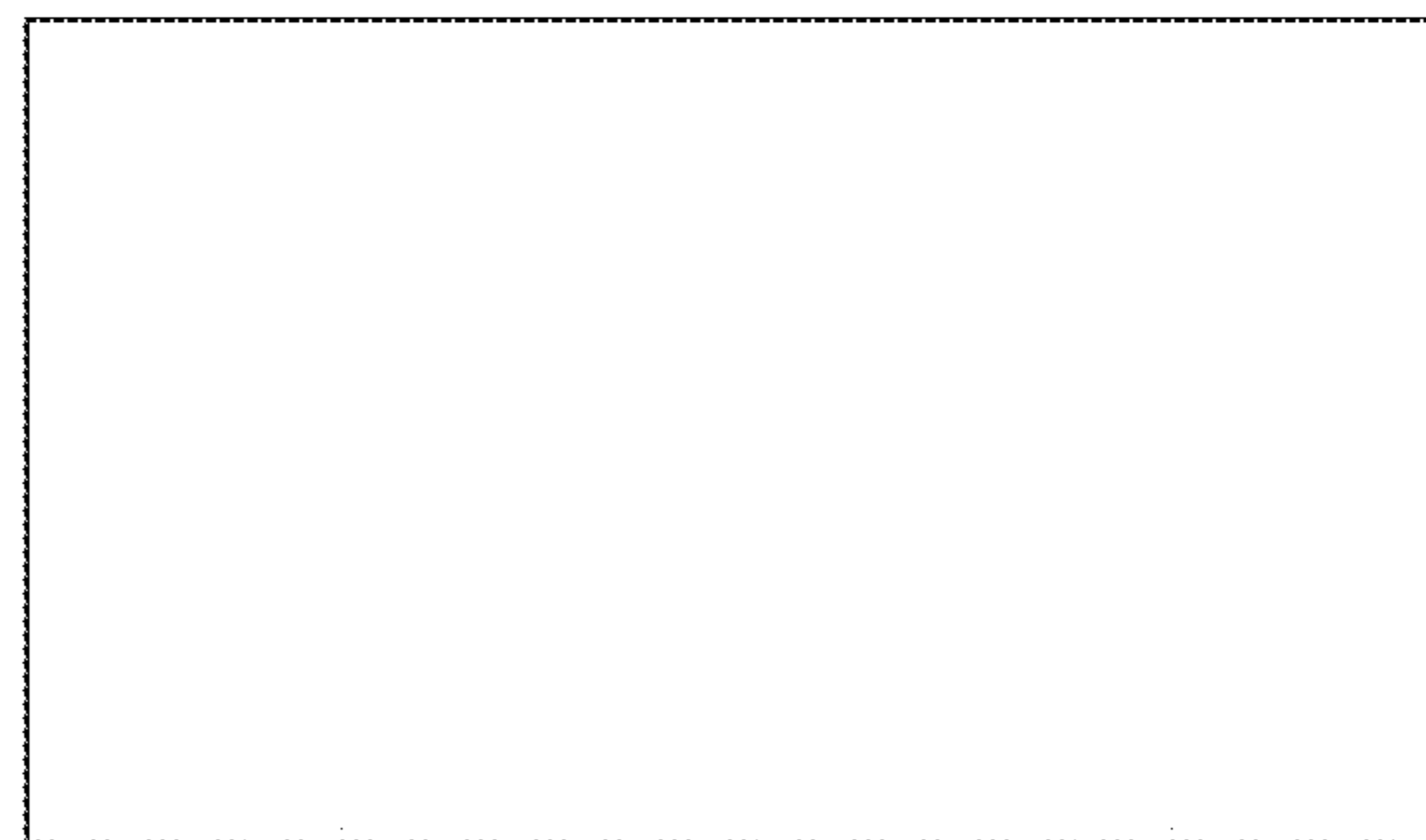

FIG. 14



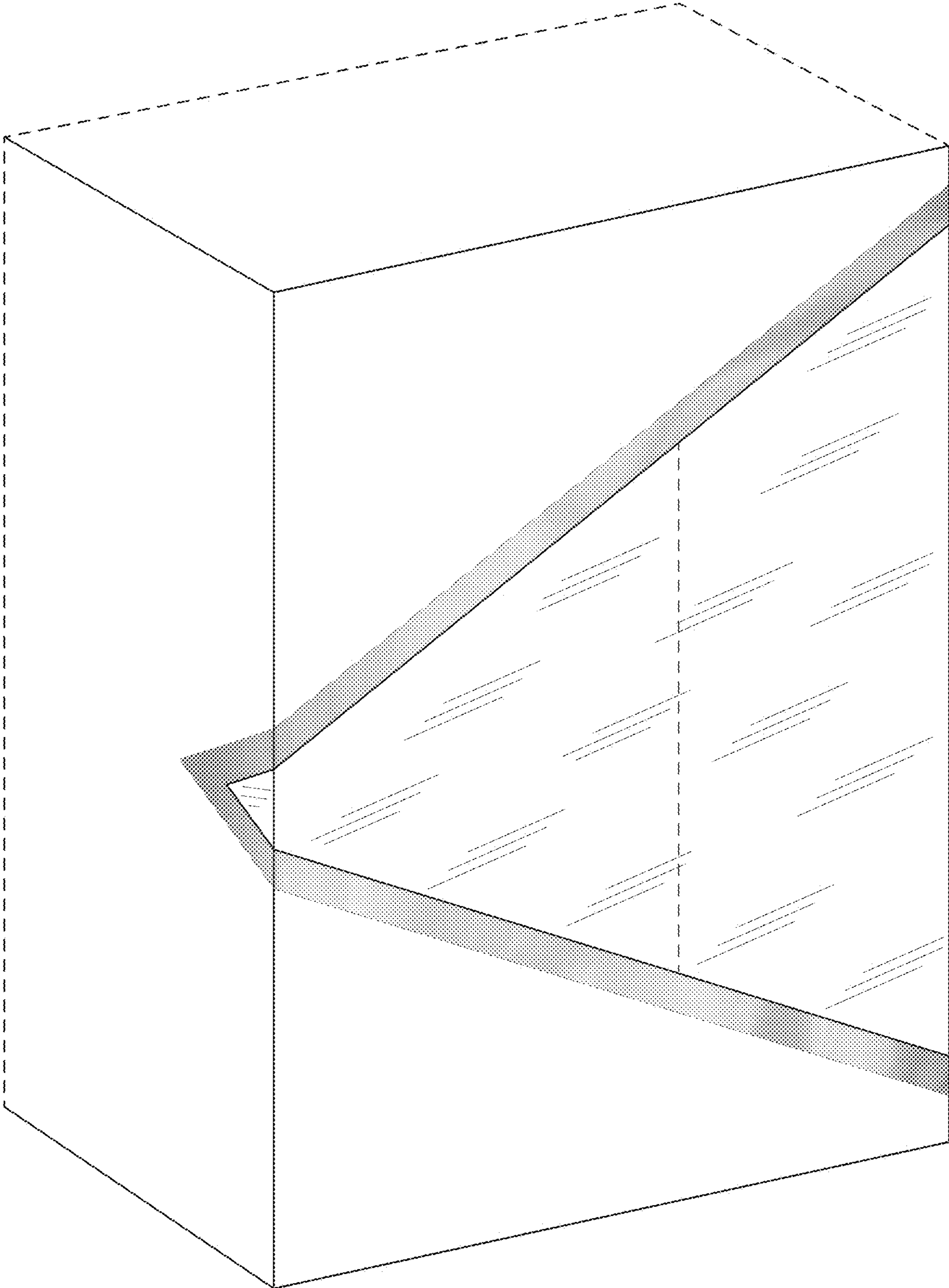

FIG. 15

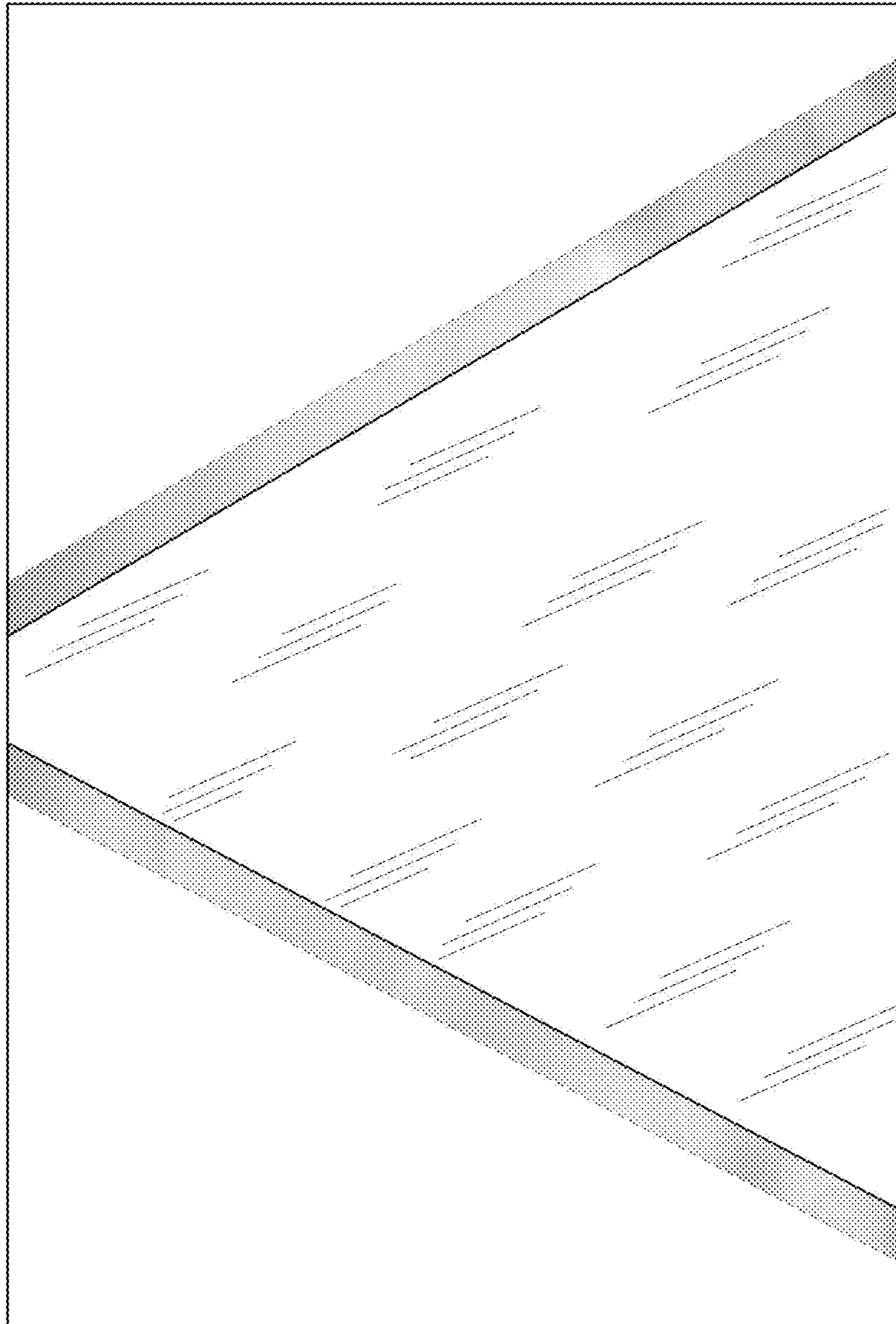

FIG. 16

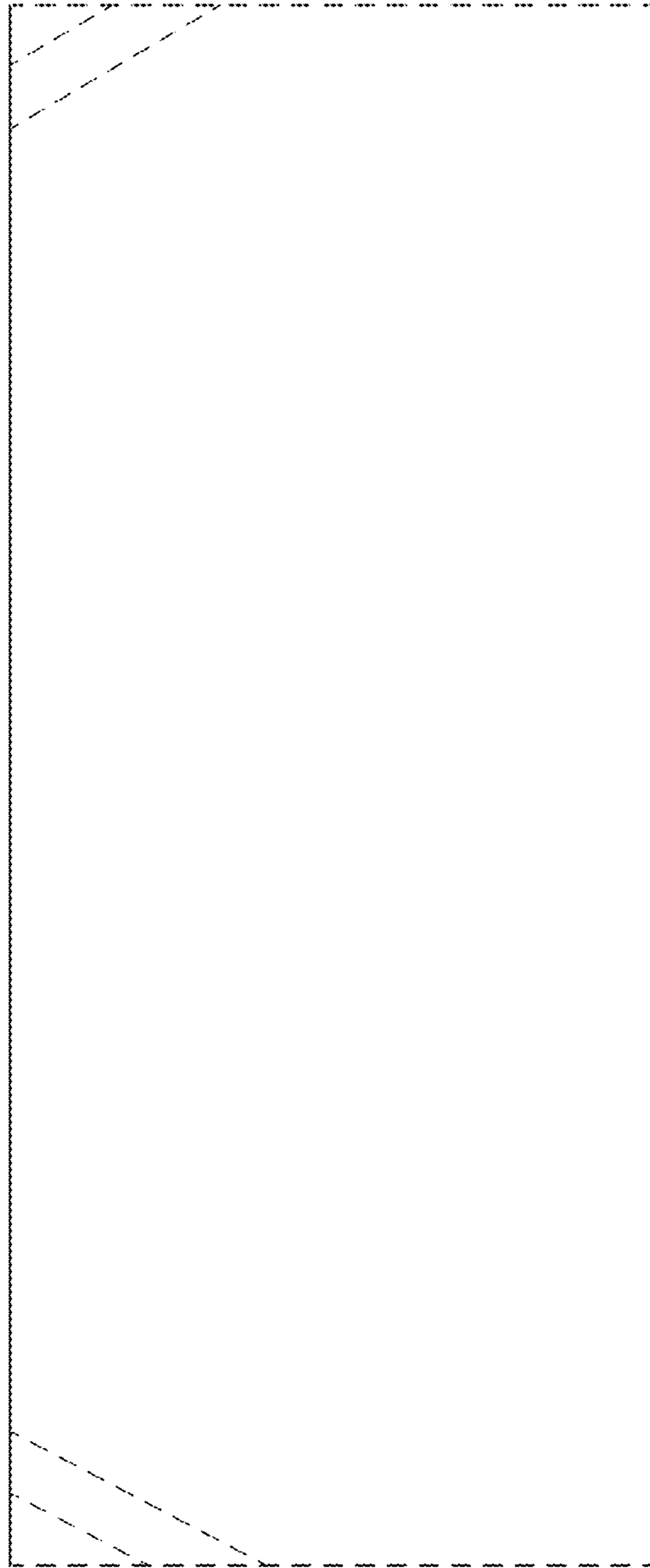

FIG. 17

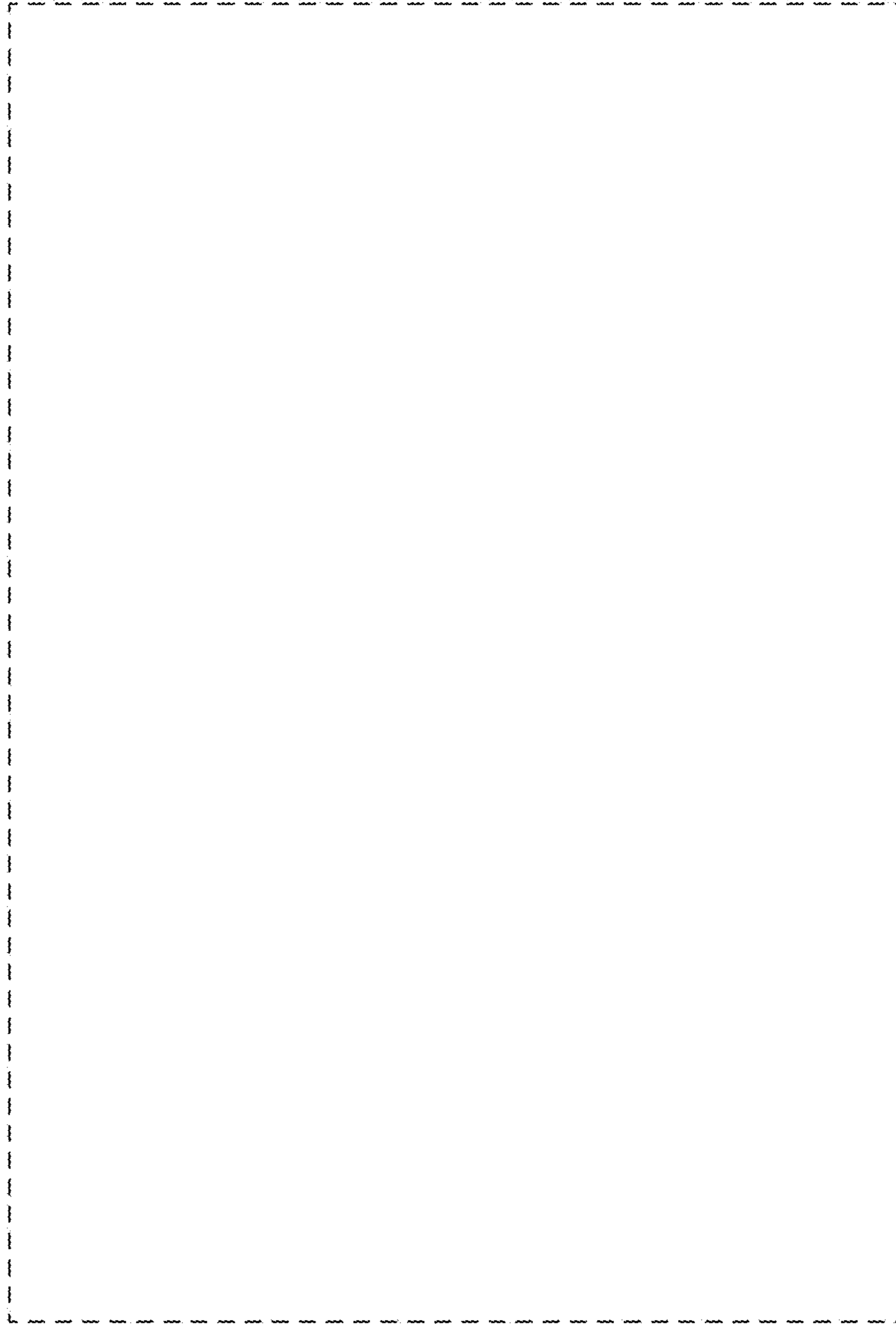

FIG. 18

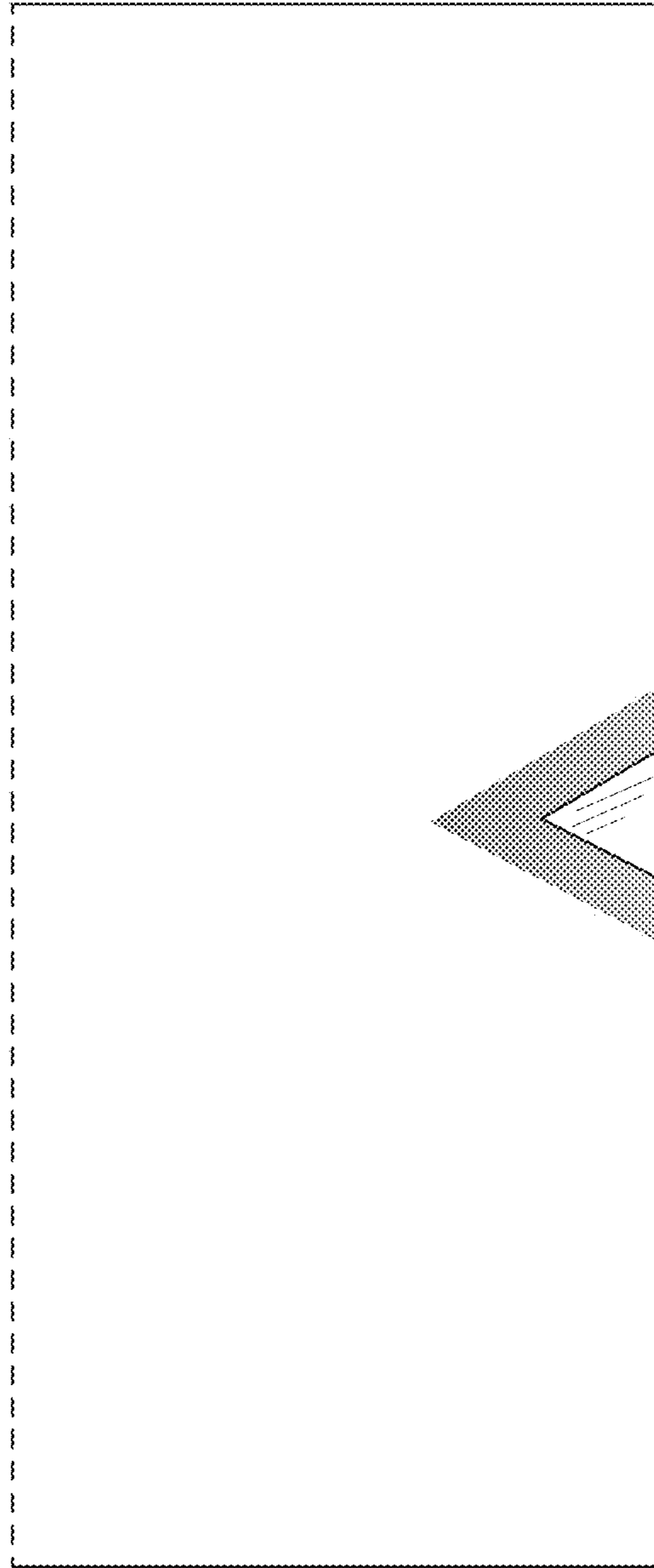

FIG. 19



FIG. 20



FIG. 21

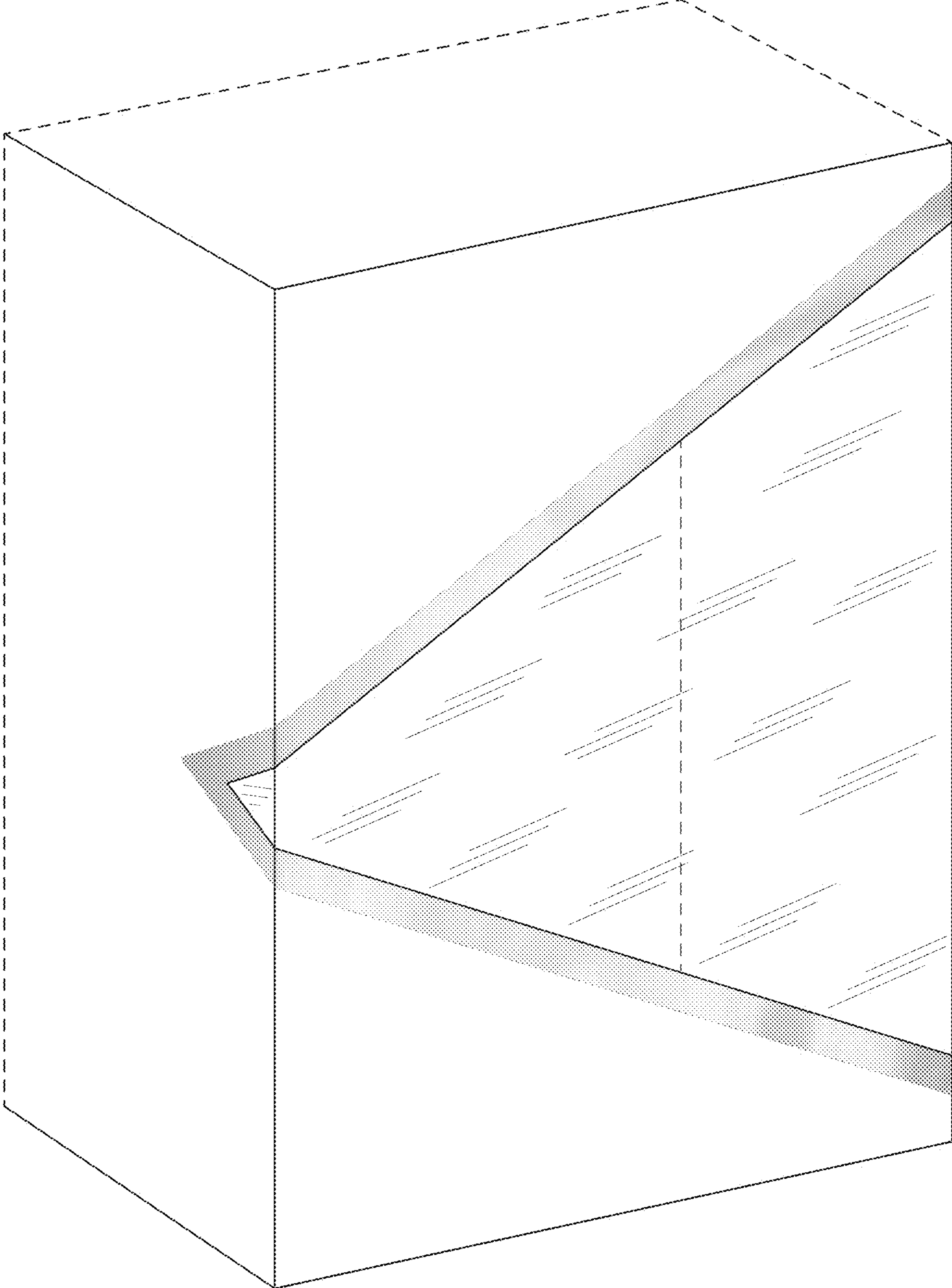

FIG. 22

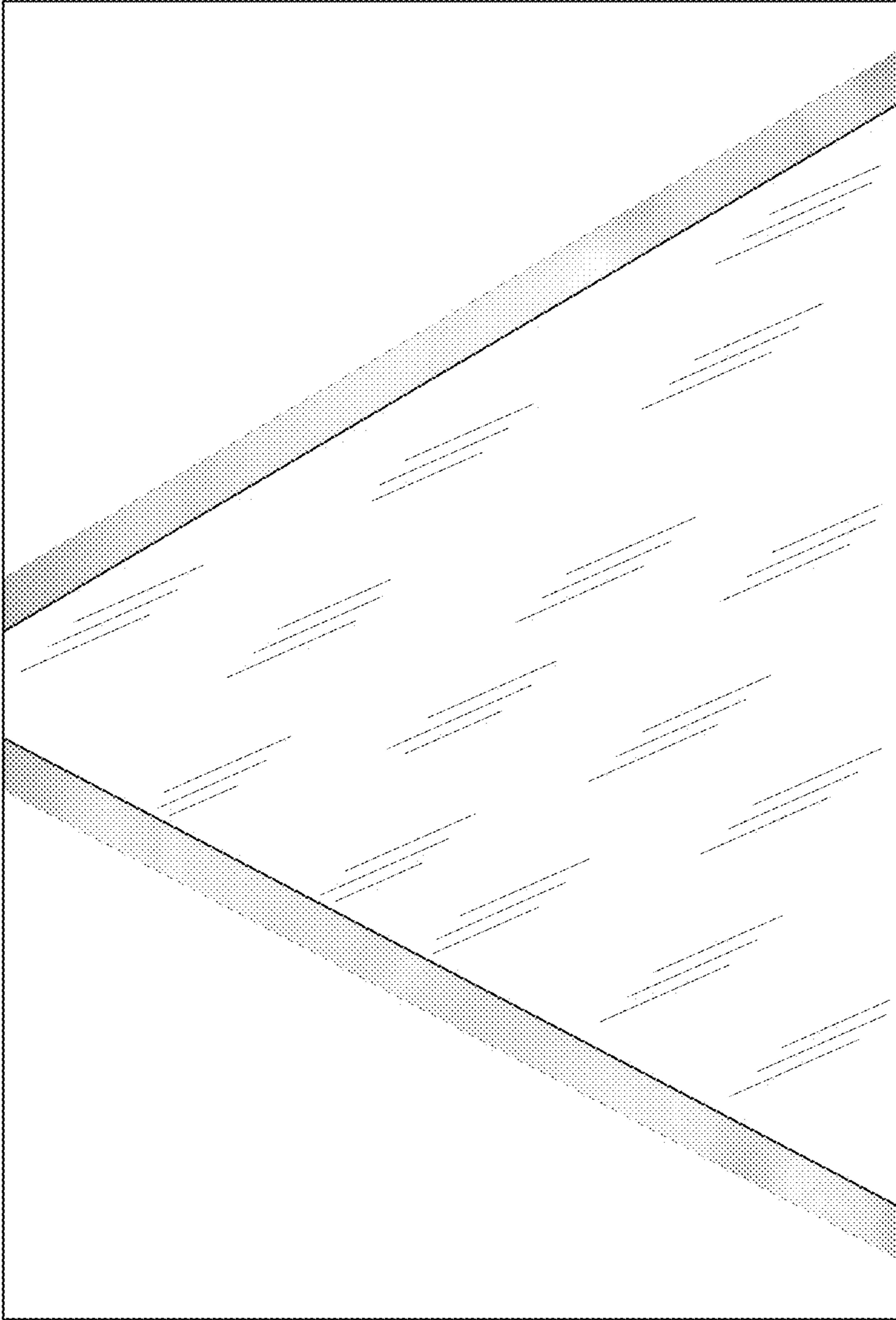

FIG. 23



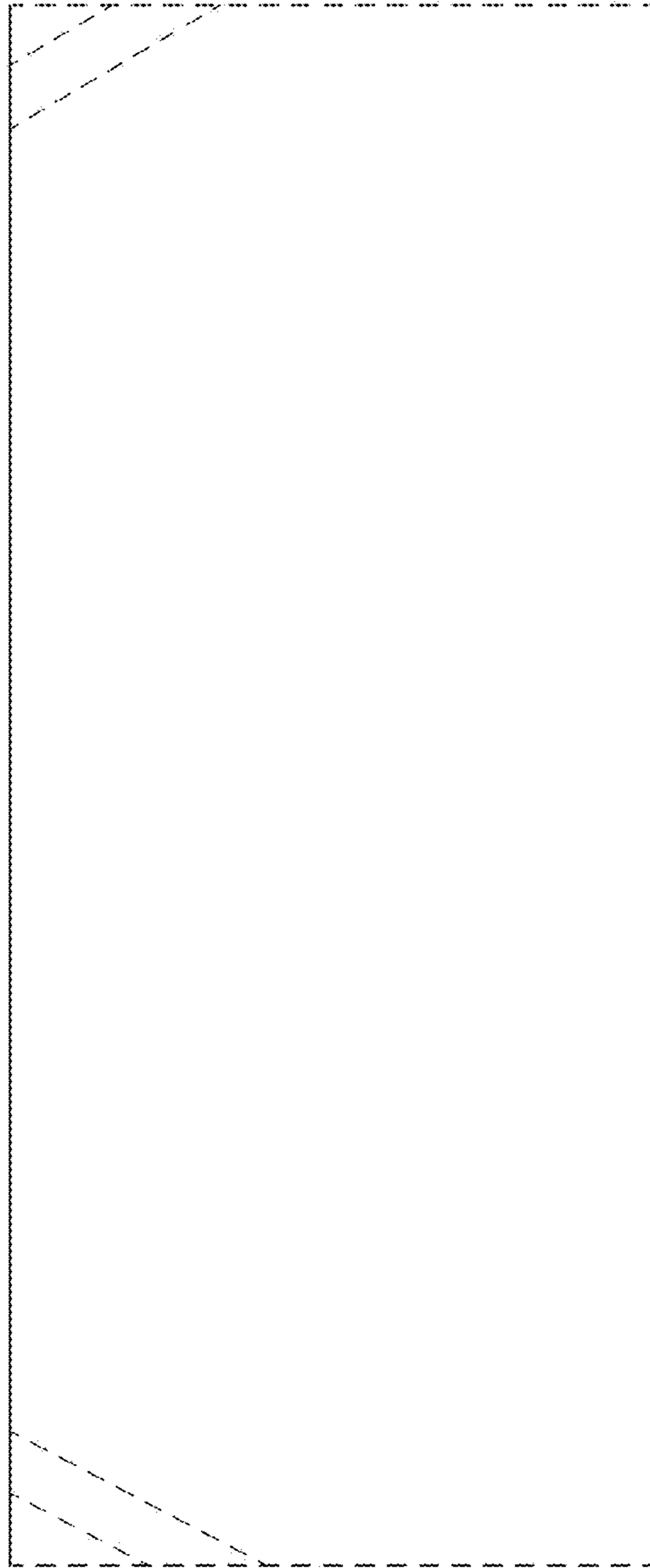

FIG. 24

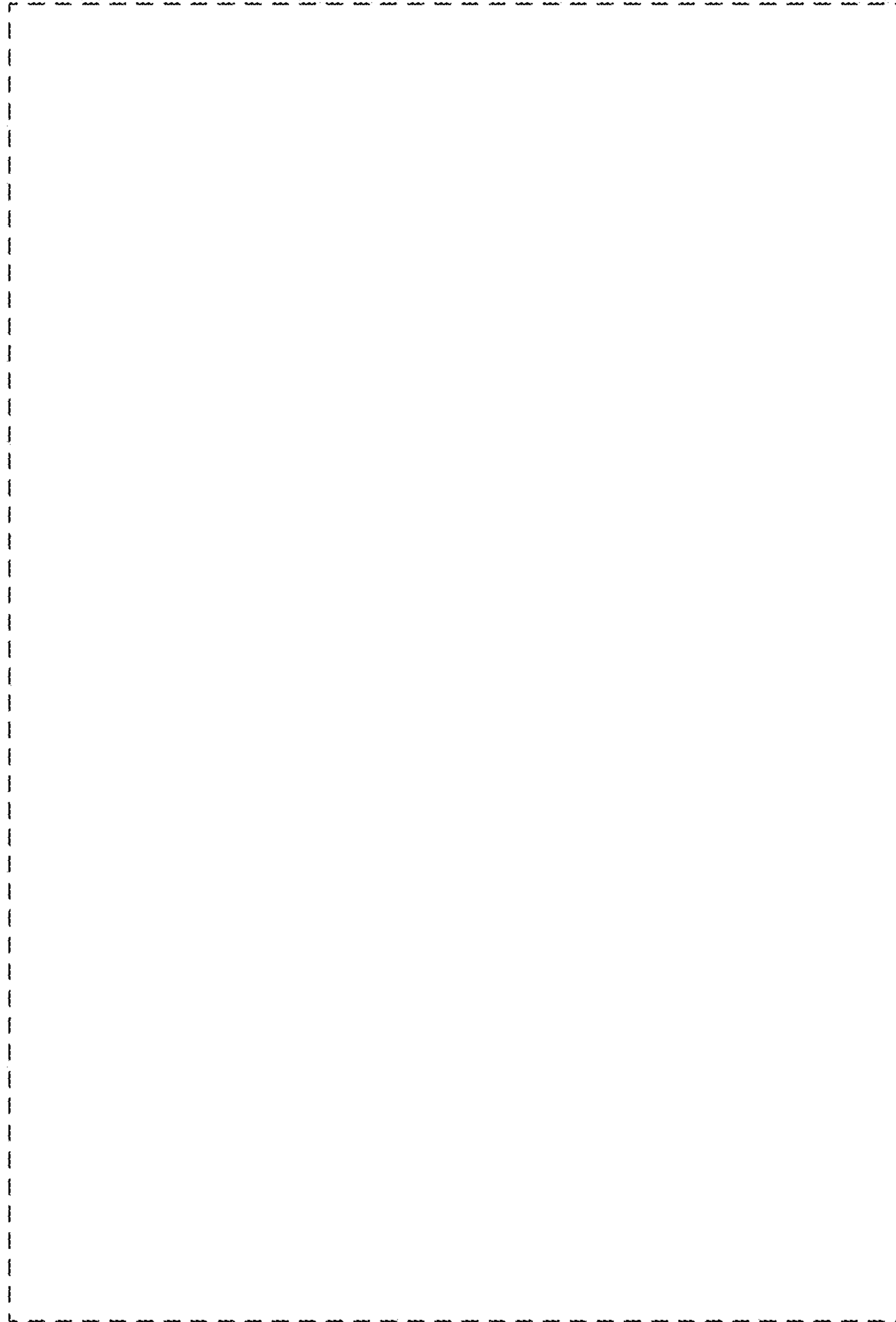

FIG. 25

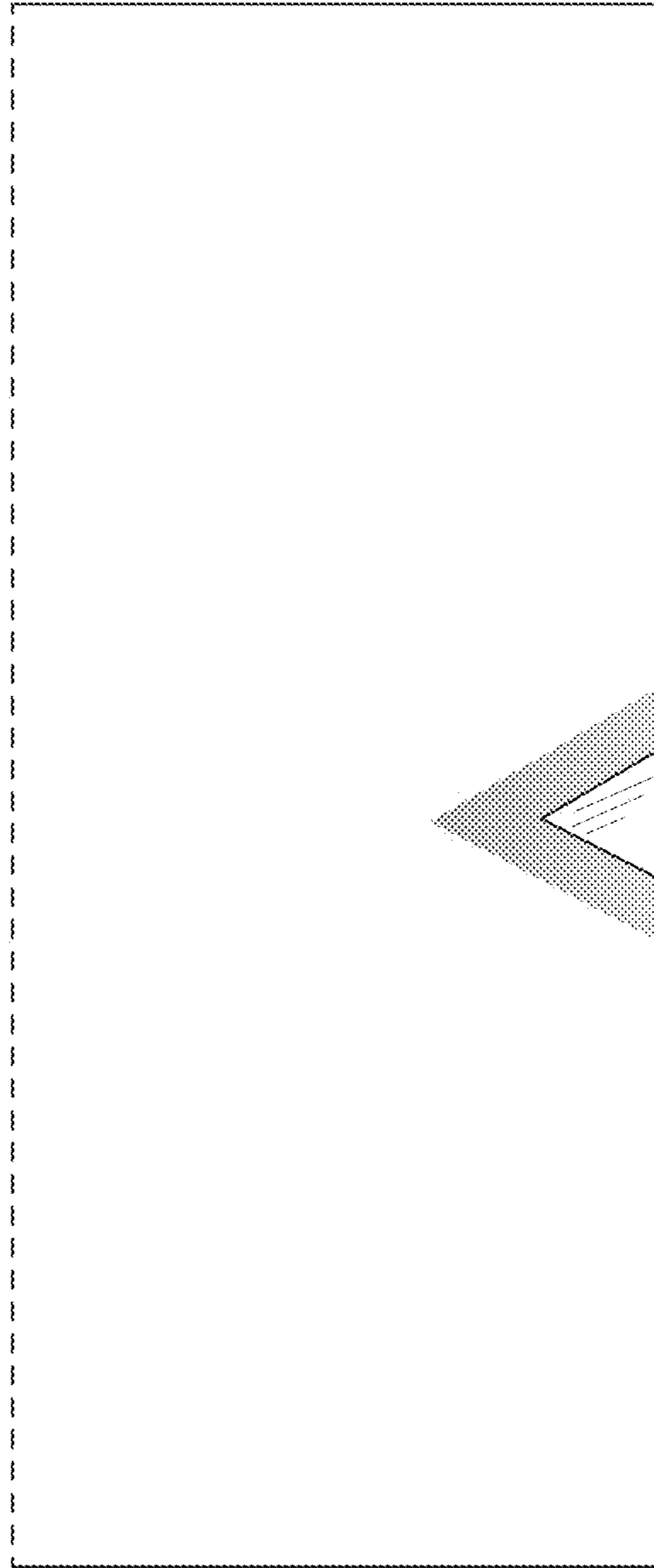

FIG. 26

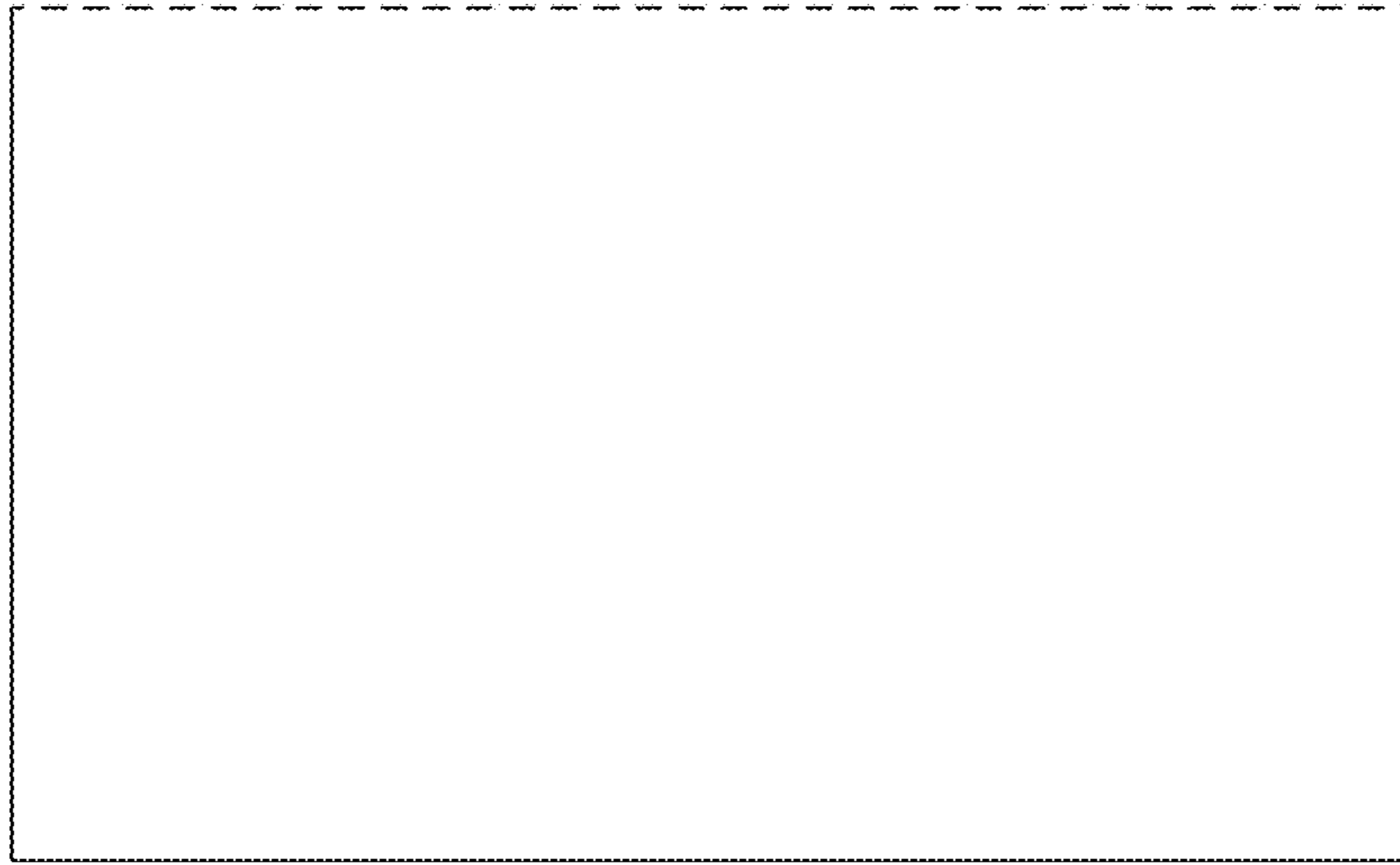

FIG. 27



FIG. 28

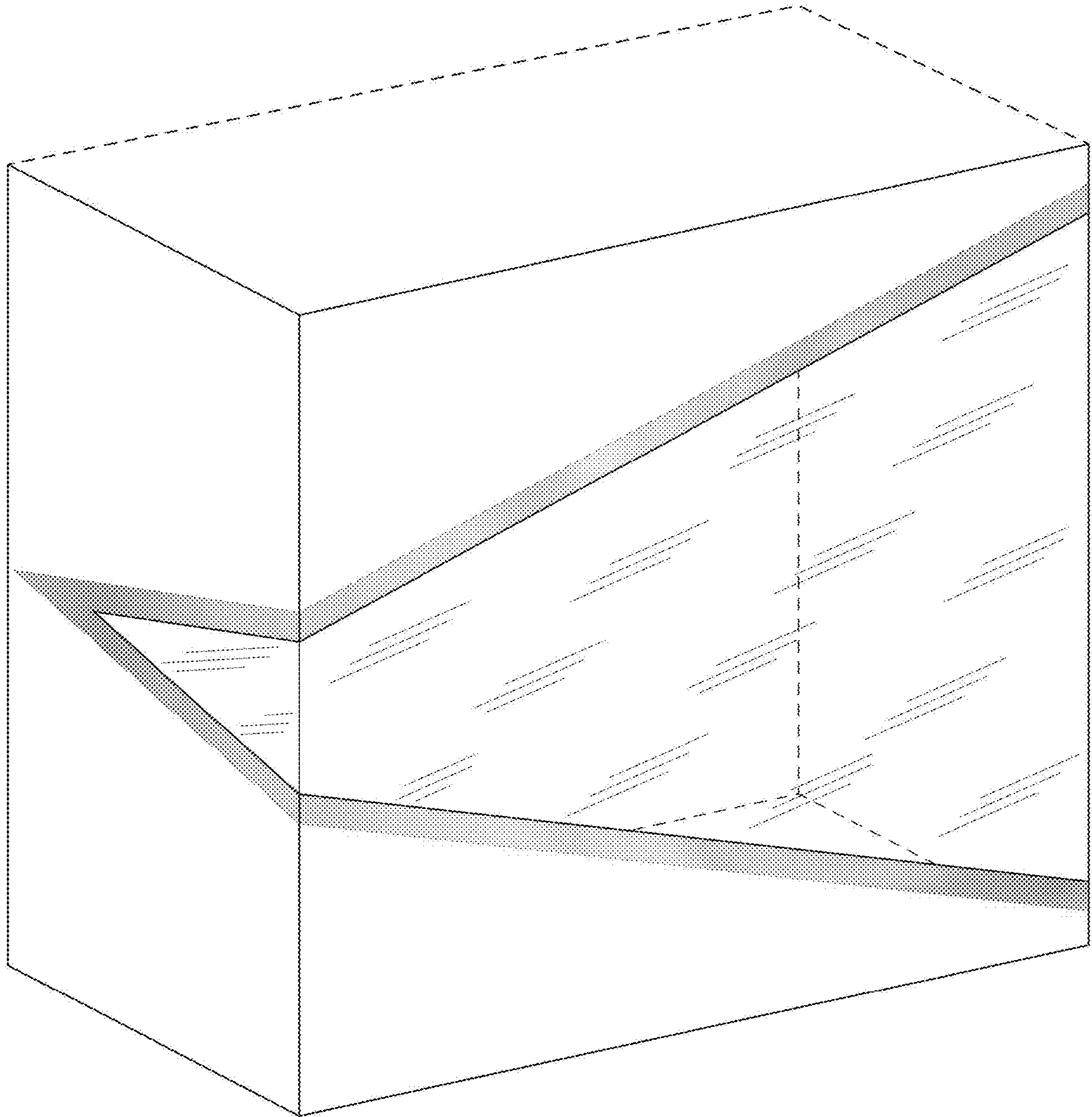

FIG. 29

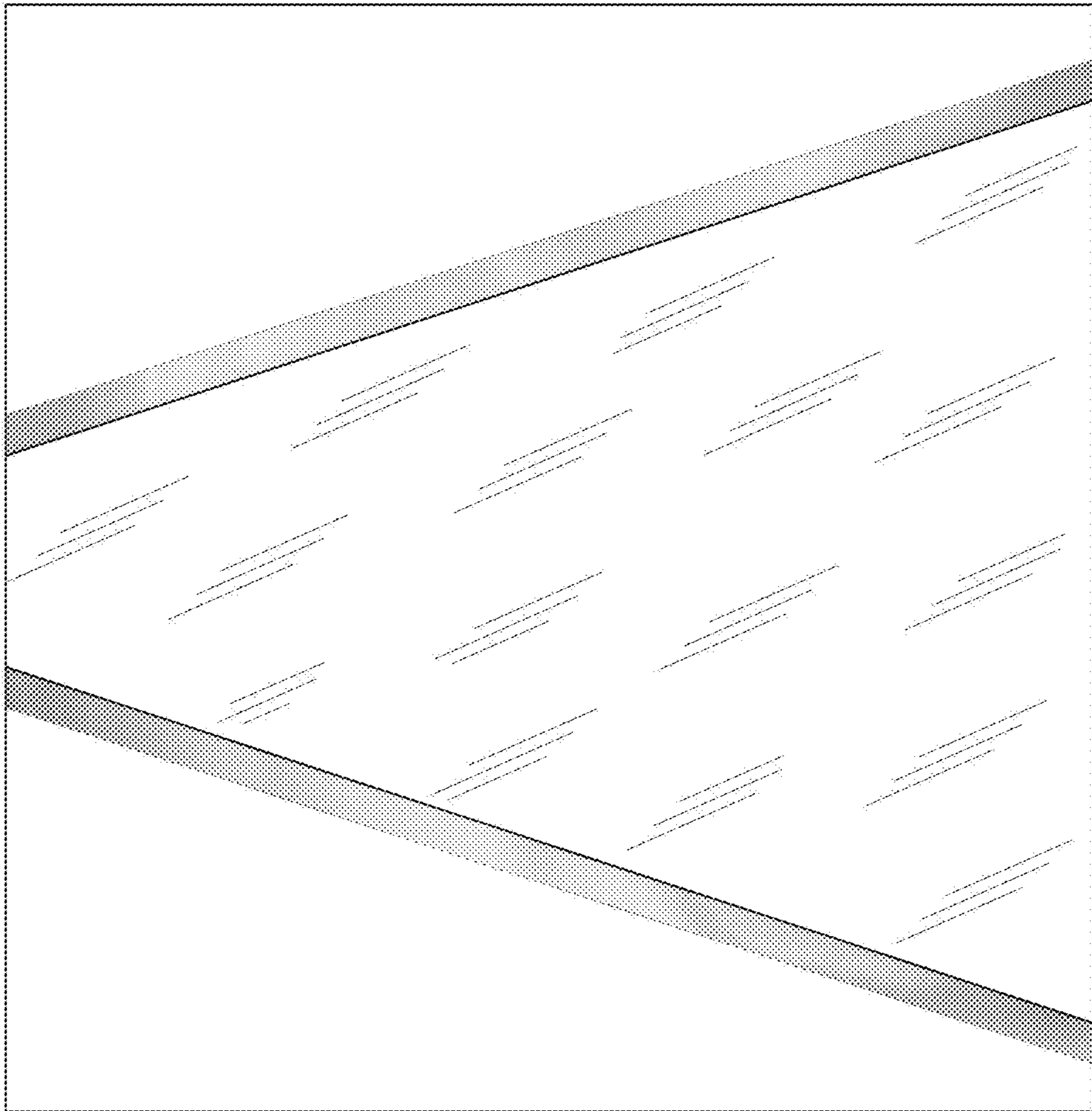

FIG. 30

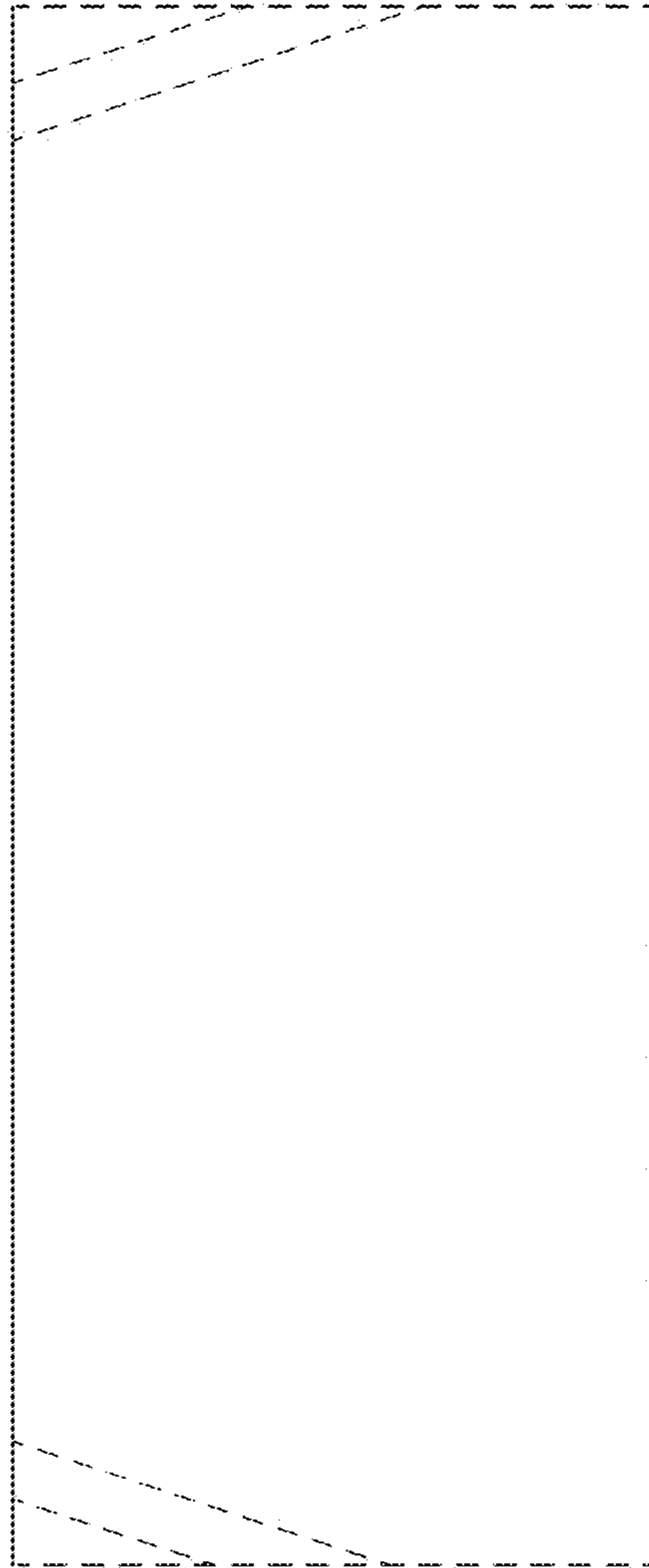

FIG. 31



FIG. 32



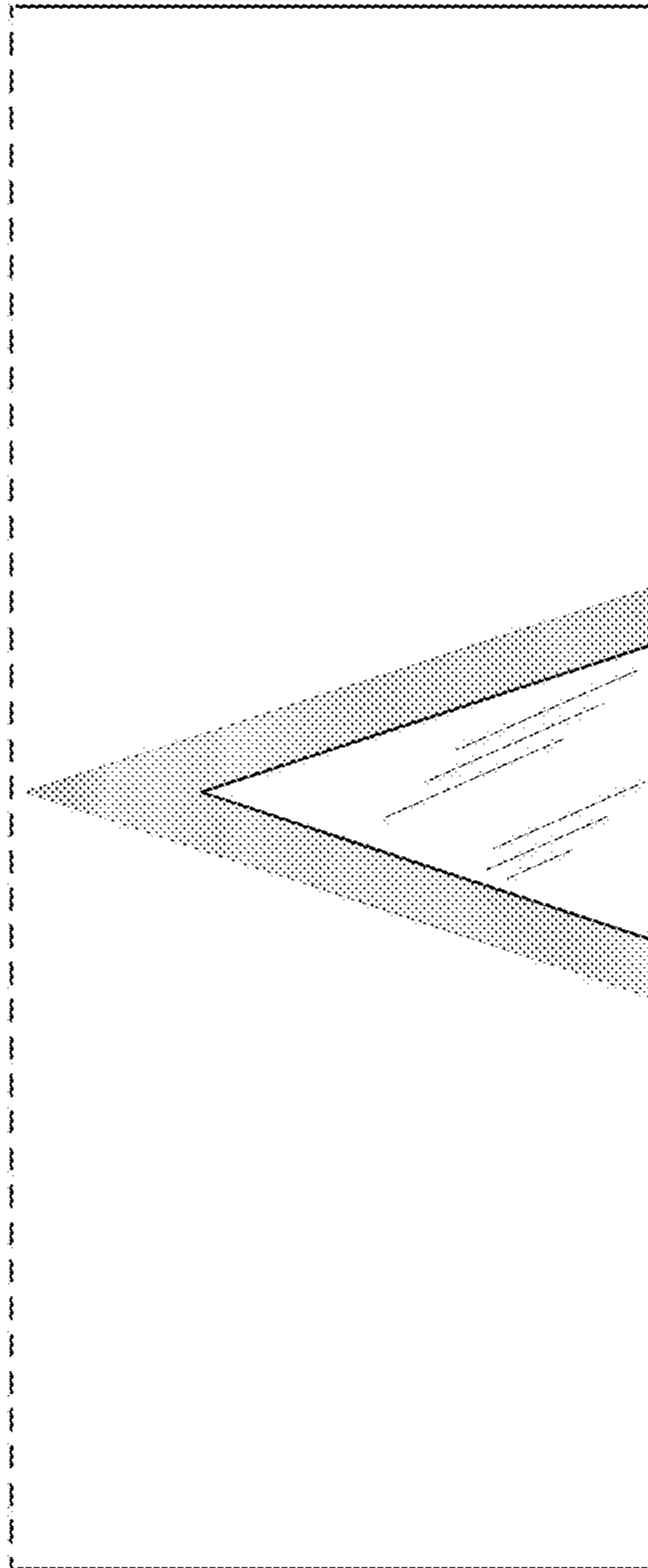

FIG. 33



FIG. 34



FIG. 35

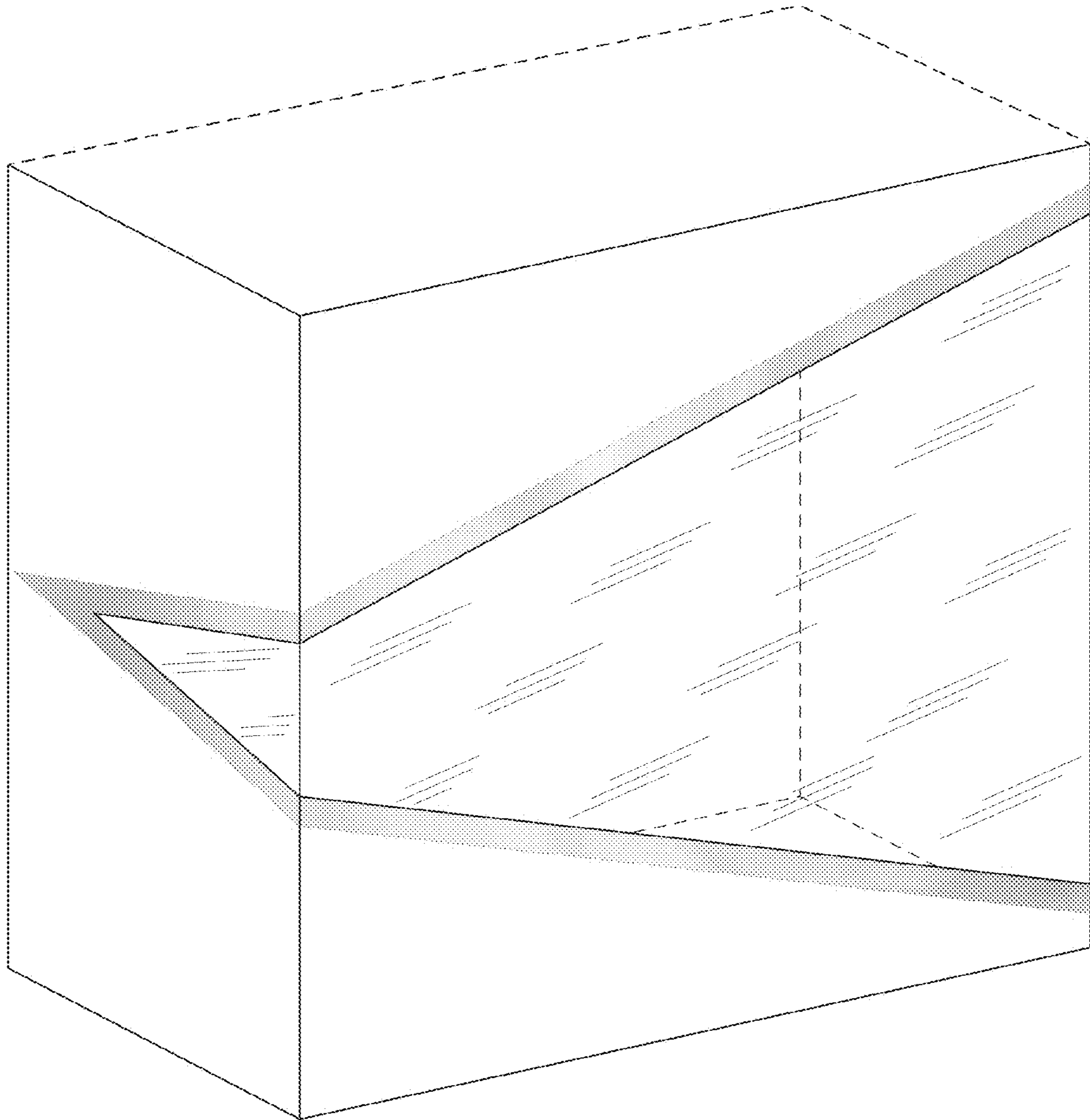

FIG. 36

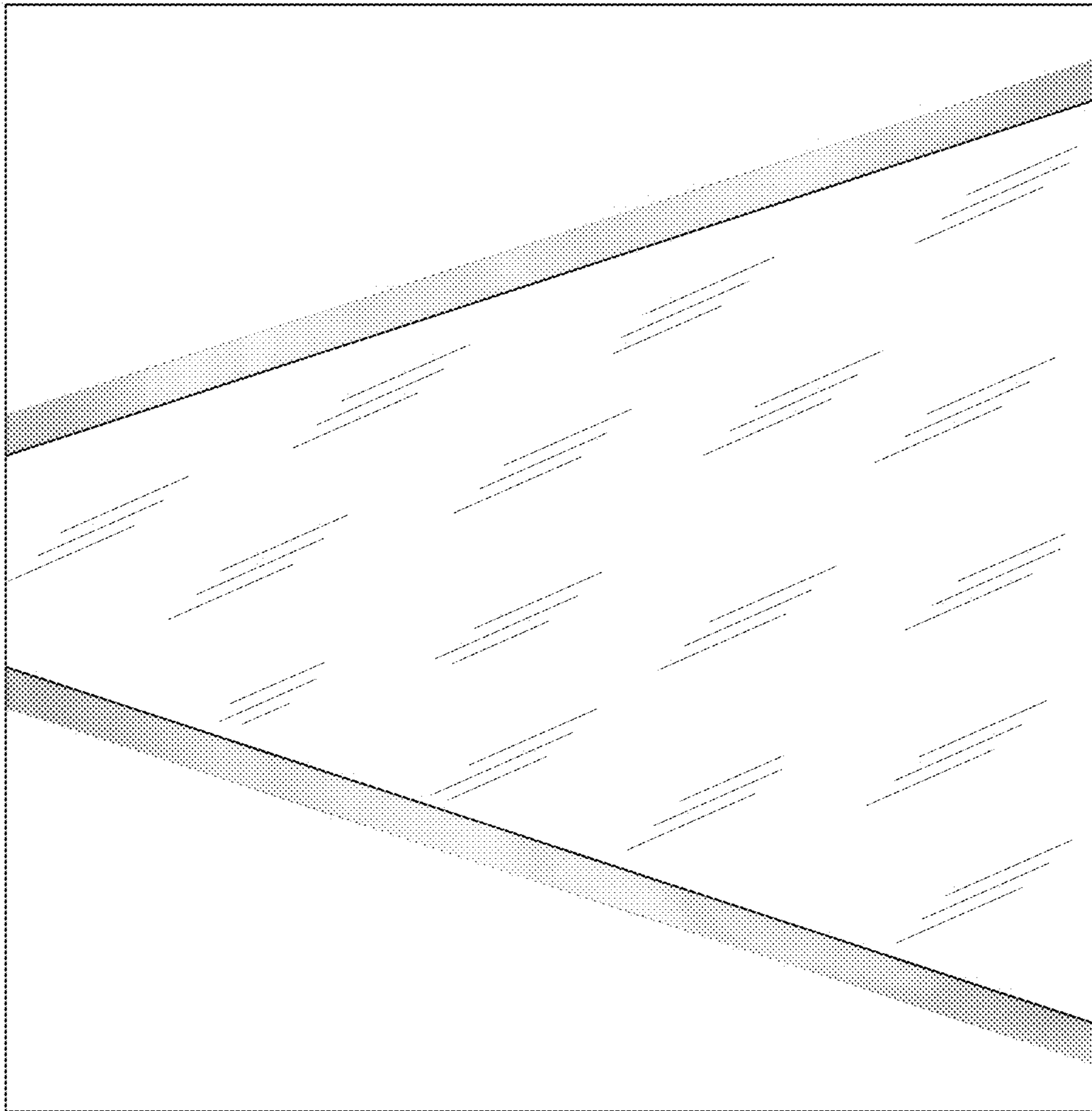

FIG. 37

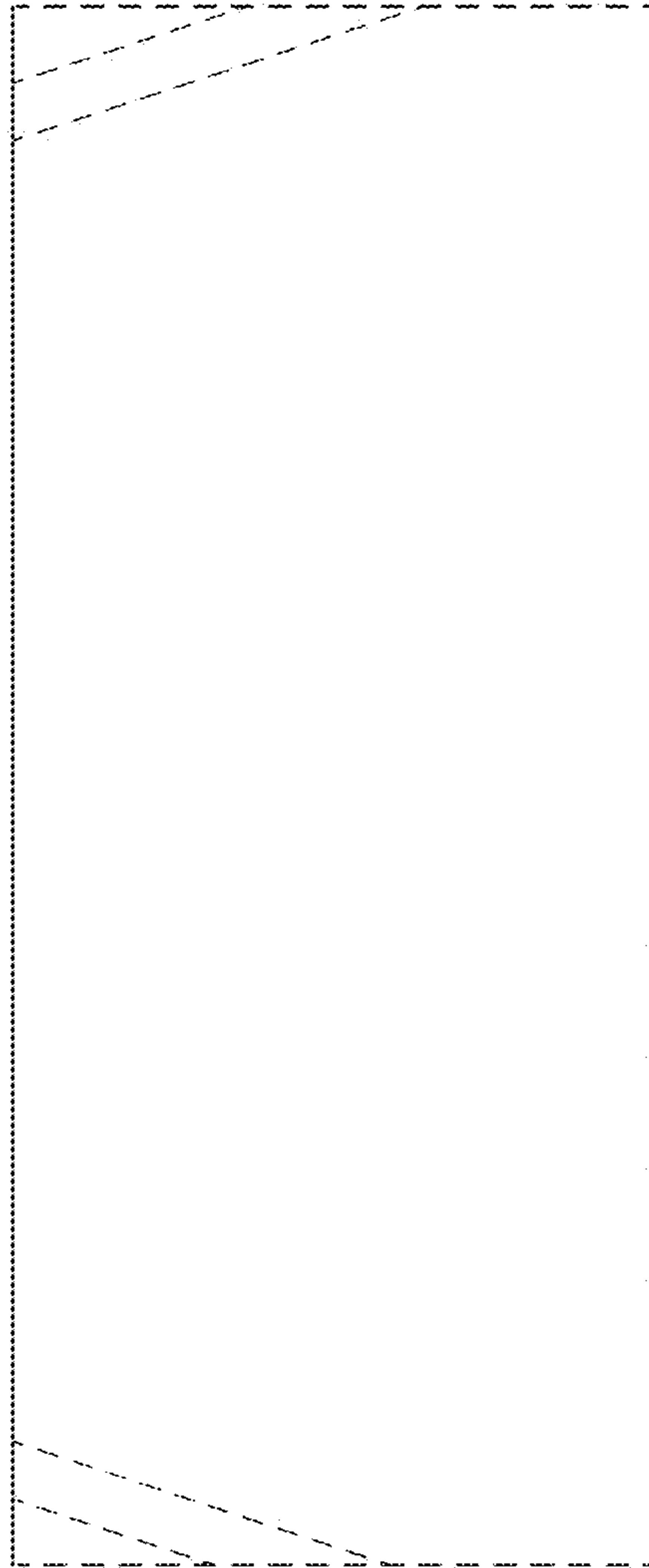

FIG. 38



FIG. 39

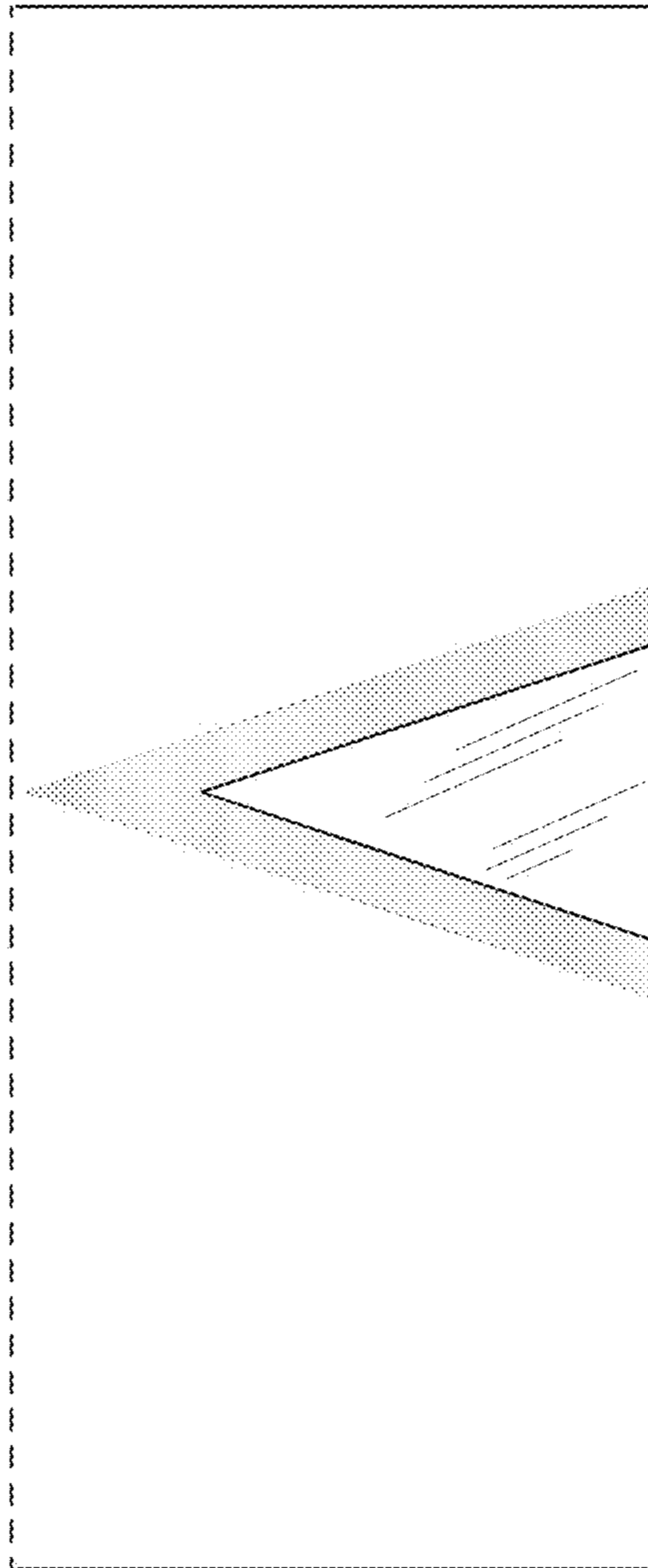

FIG. 40



FIG. 41



FIG. 42



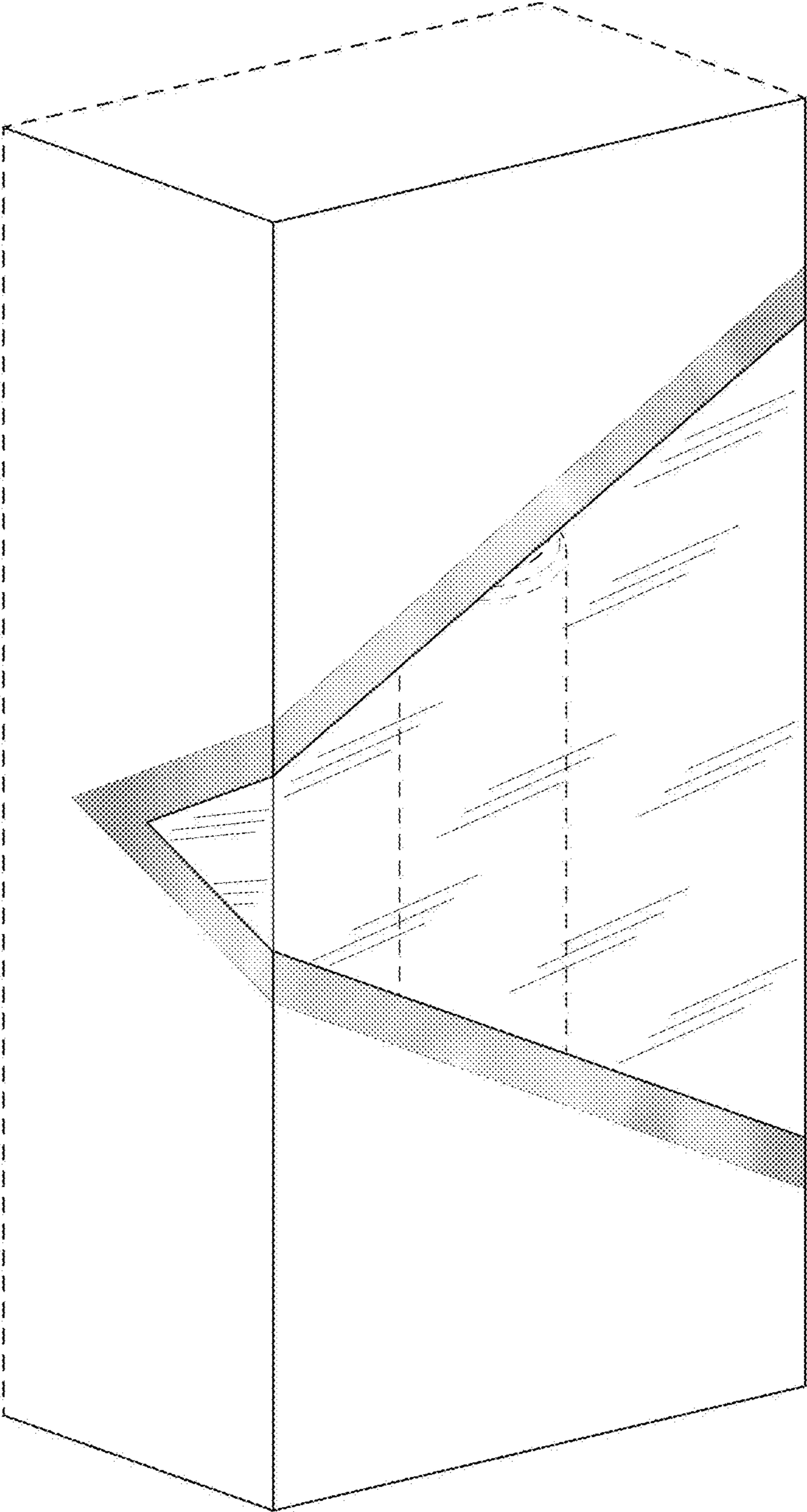

FIG. 43

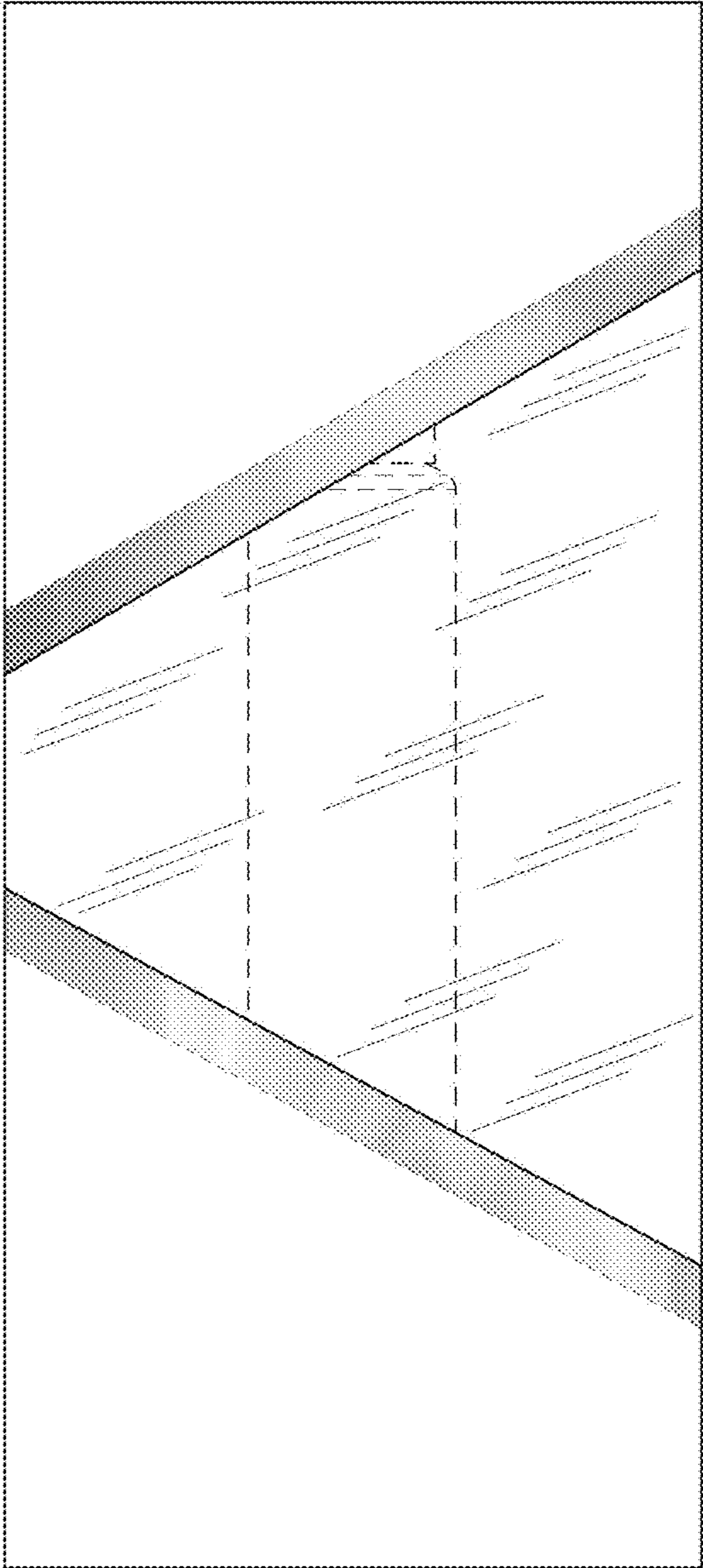

FIG. 44

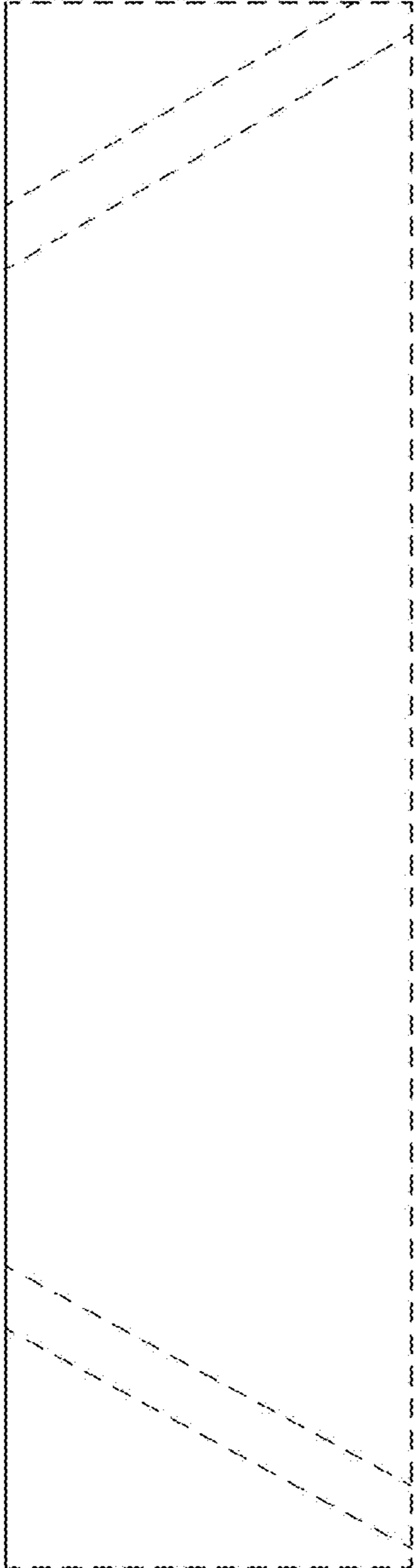

FIG. 45

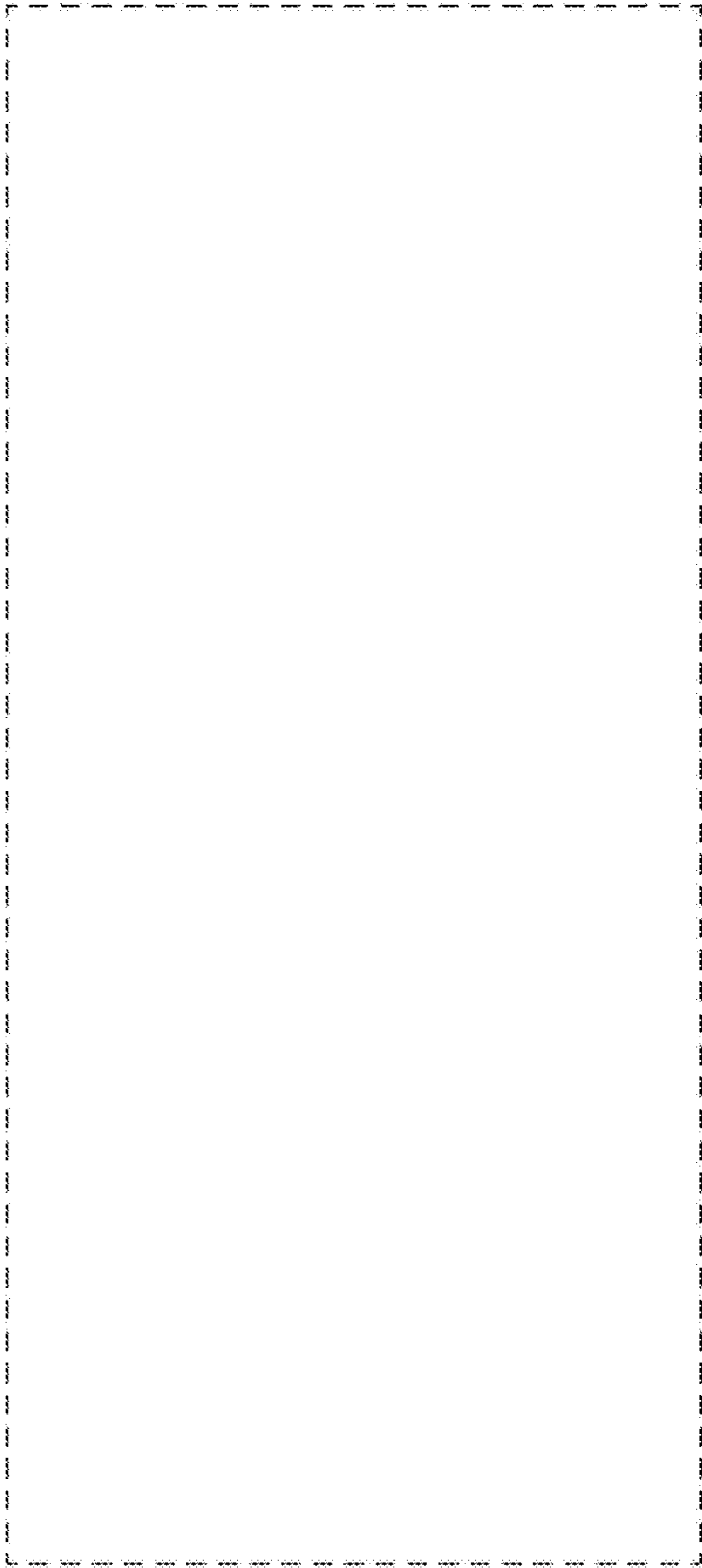

FIG. 46

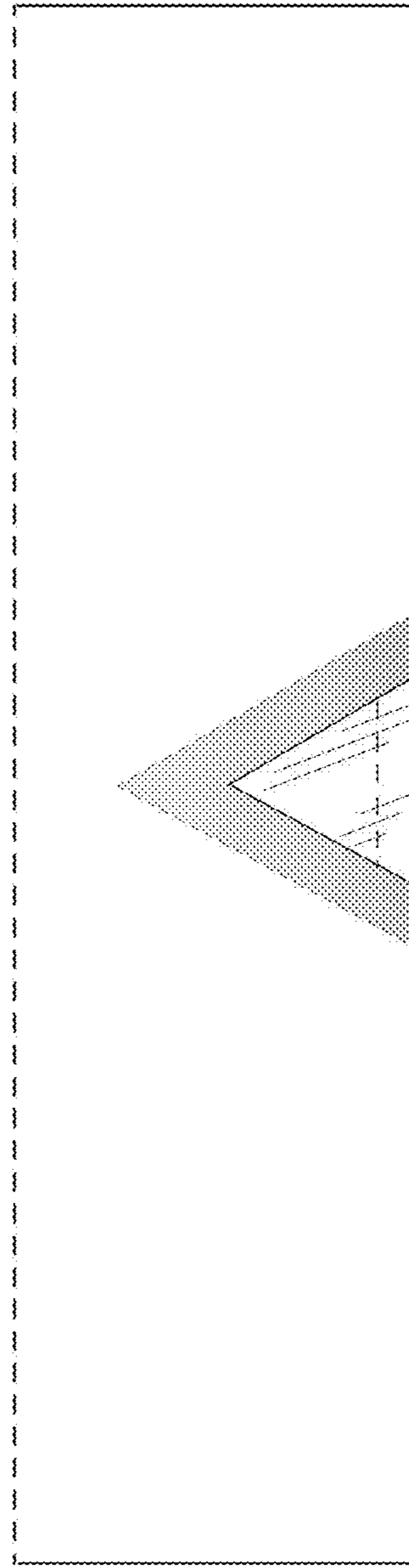

FIG. 47

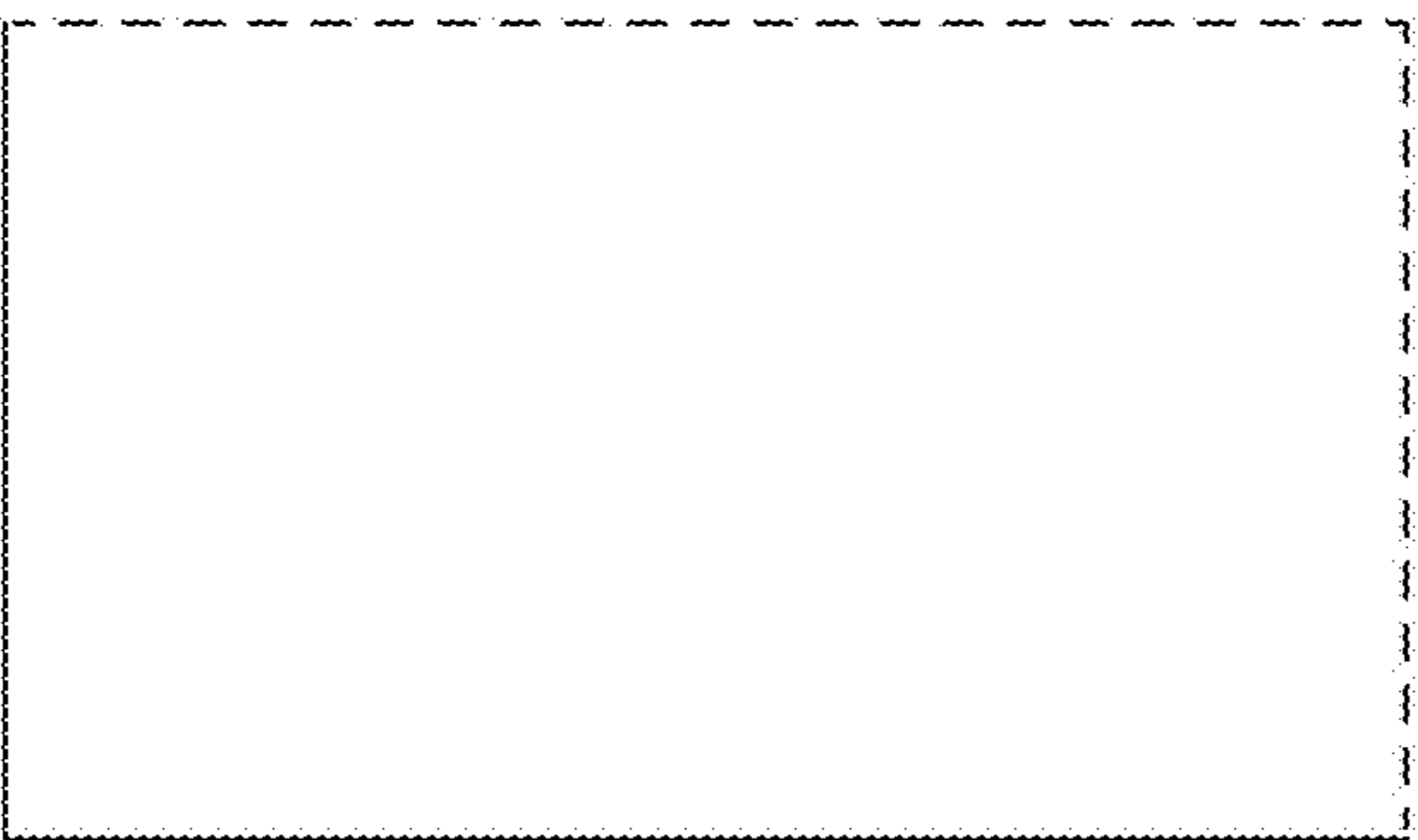

FIG. 48

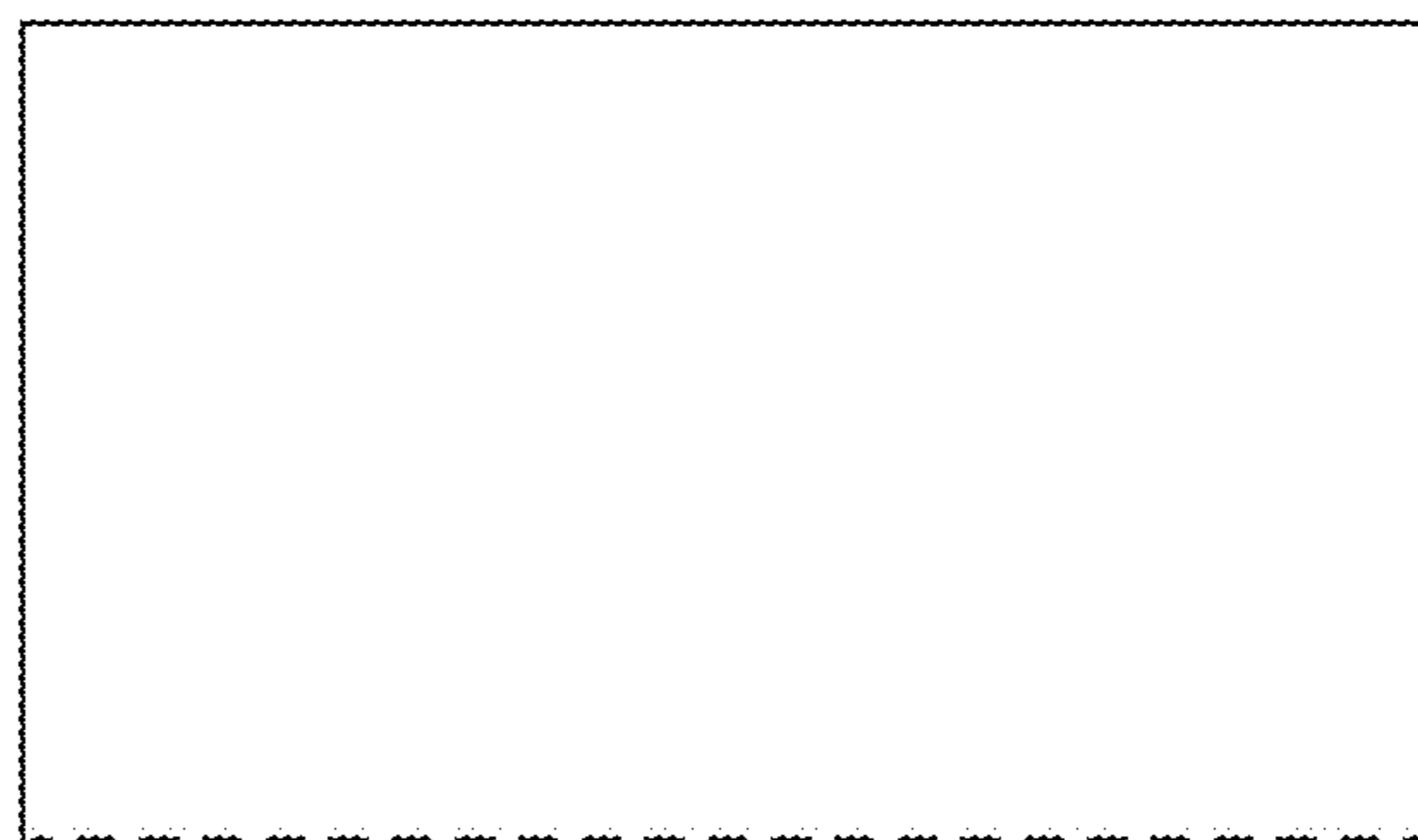

FIG. 49

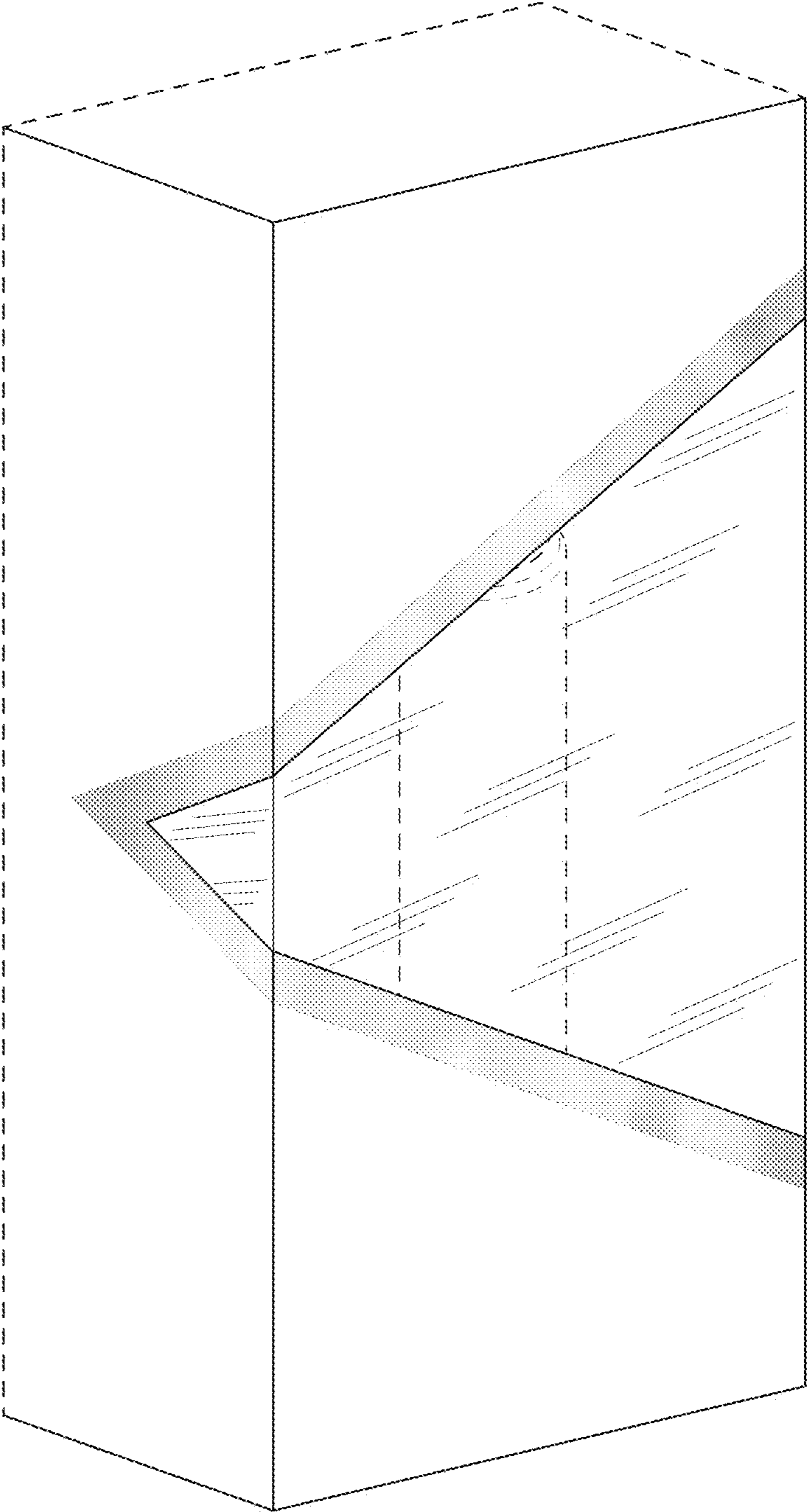

FIG. 50

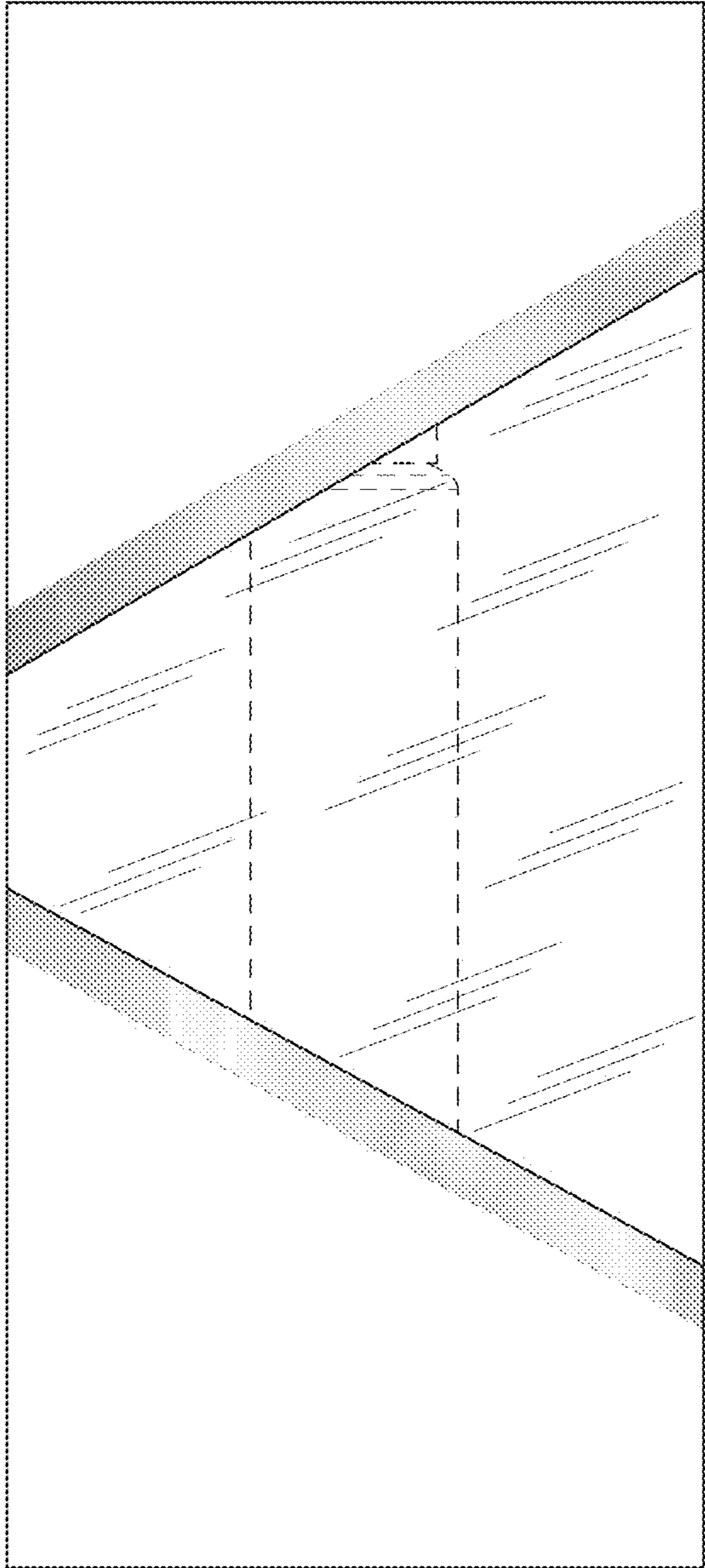

FIG. 51

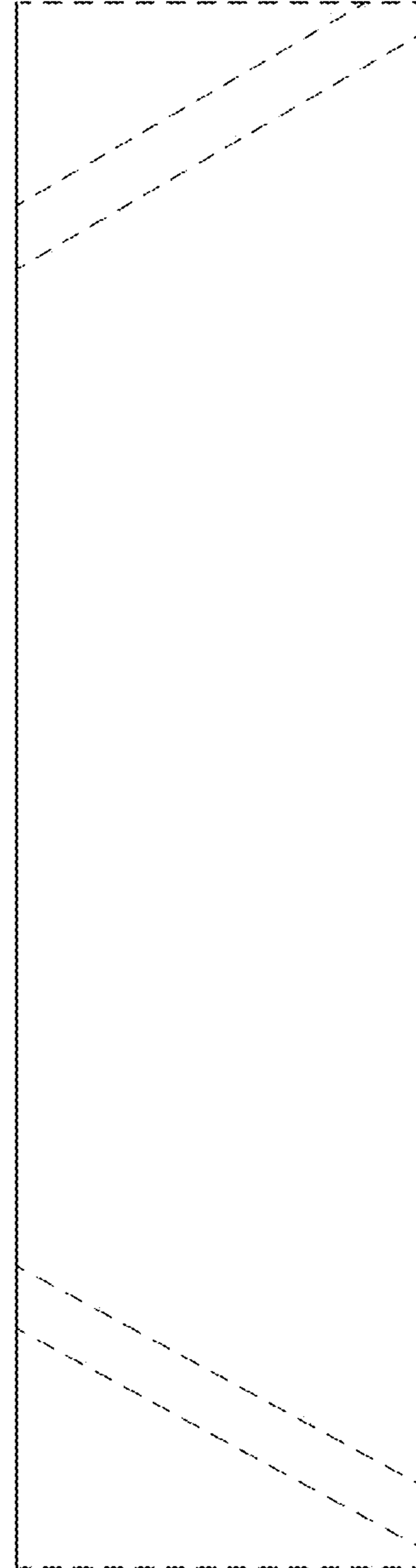

FIG. 52

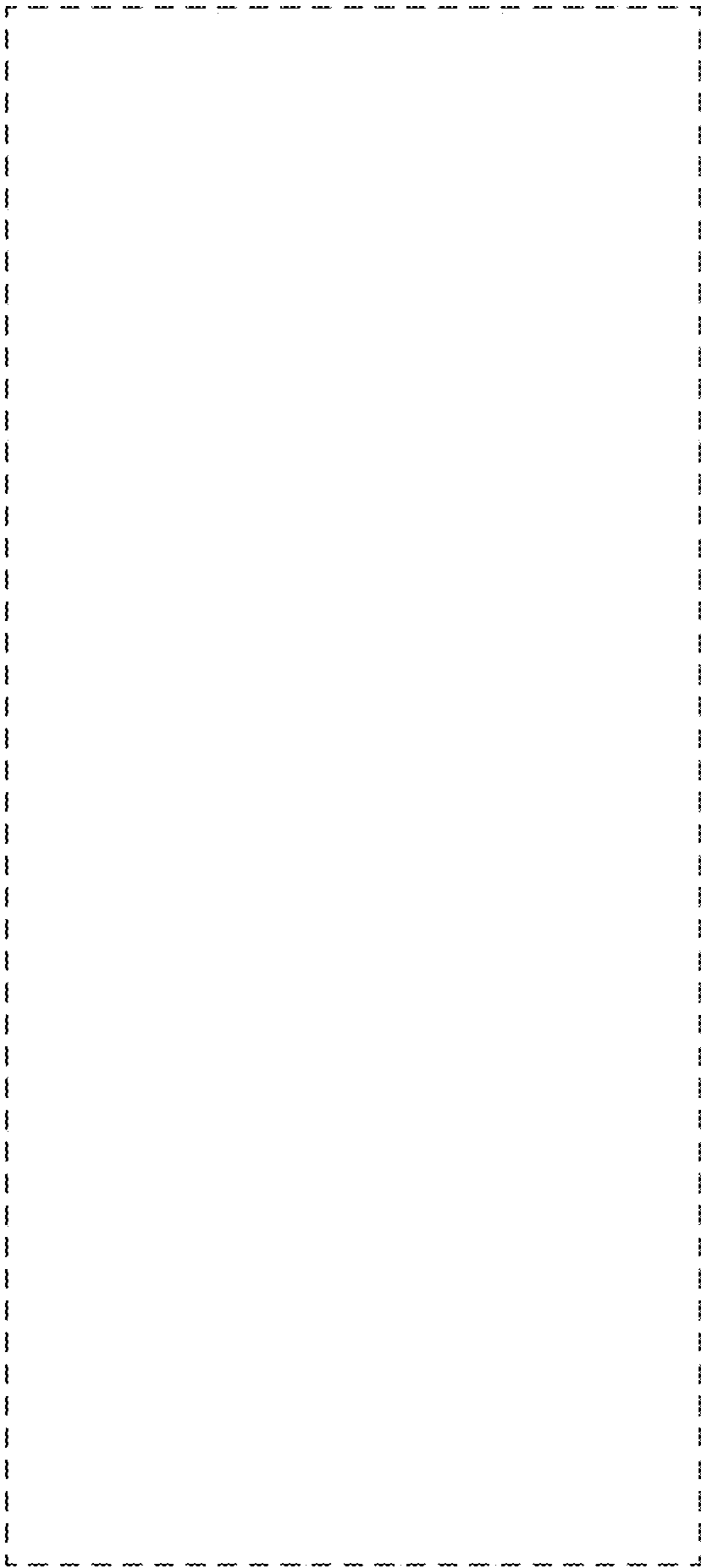

FIG. 53

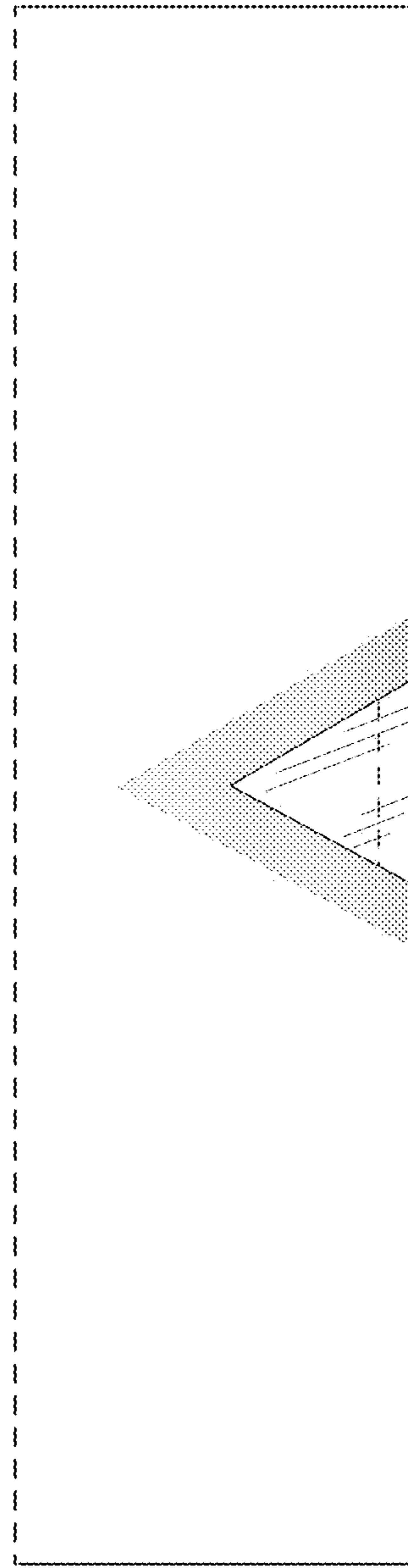

FIG. 54

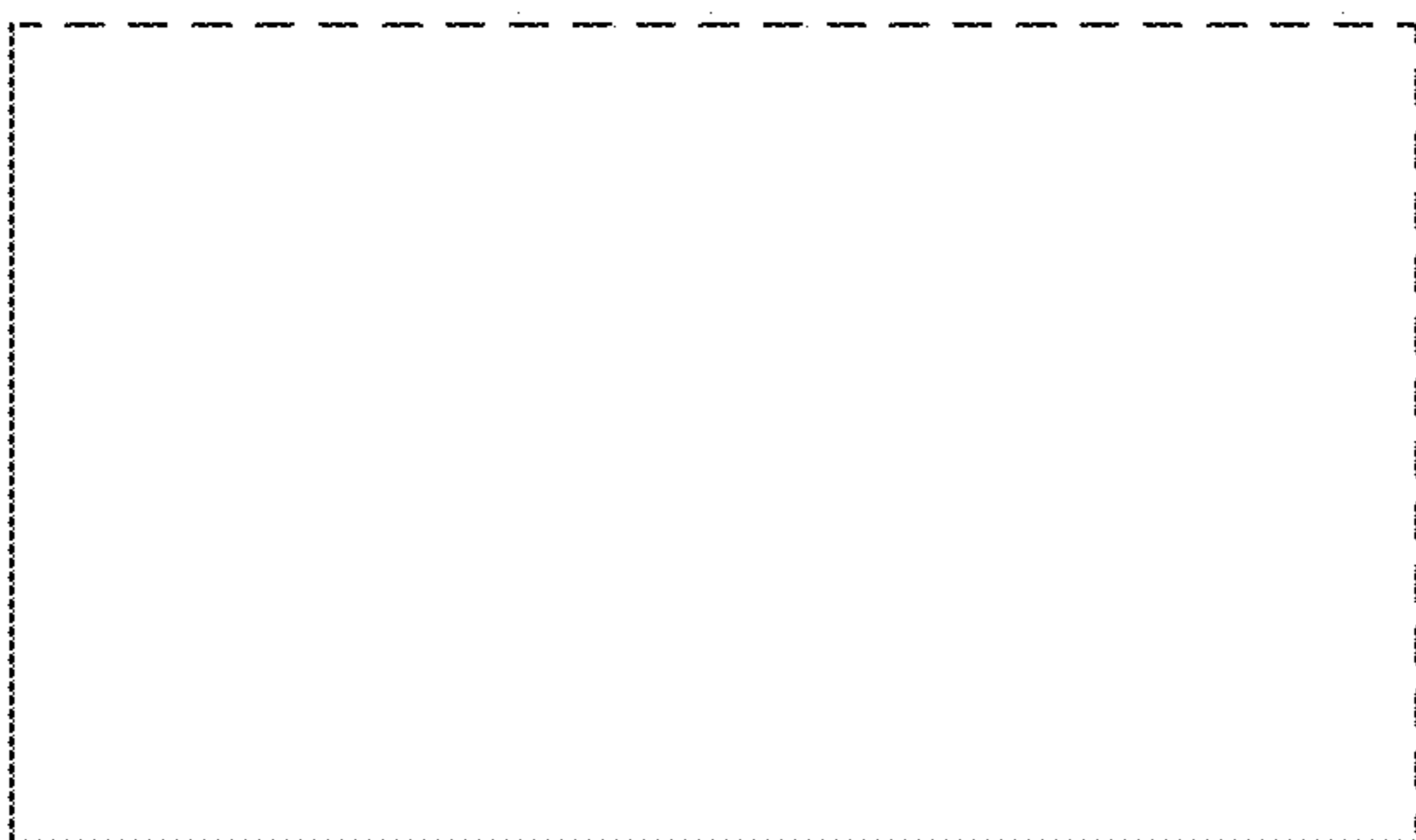

FIG. 55

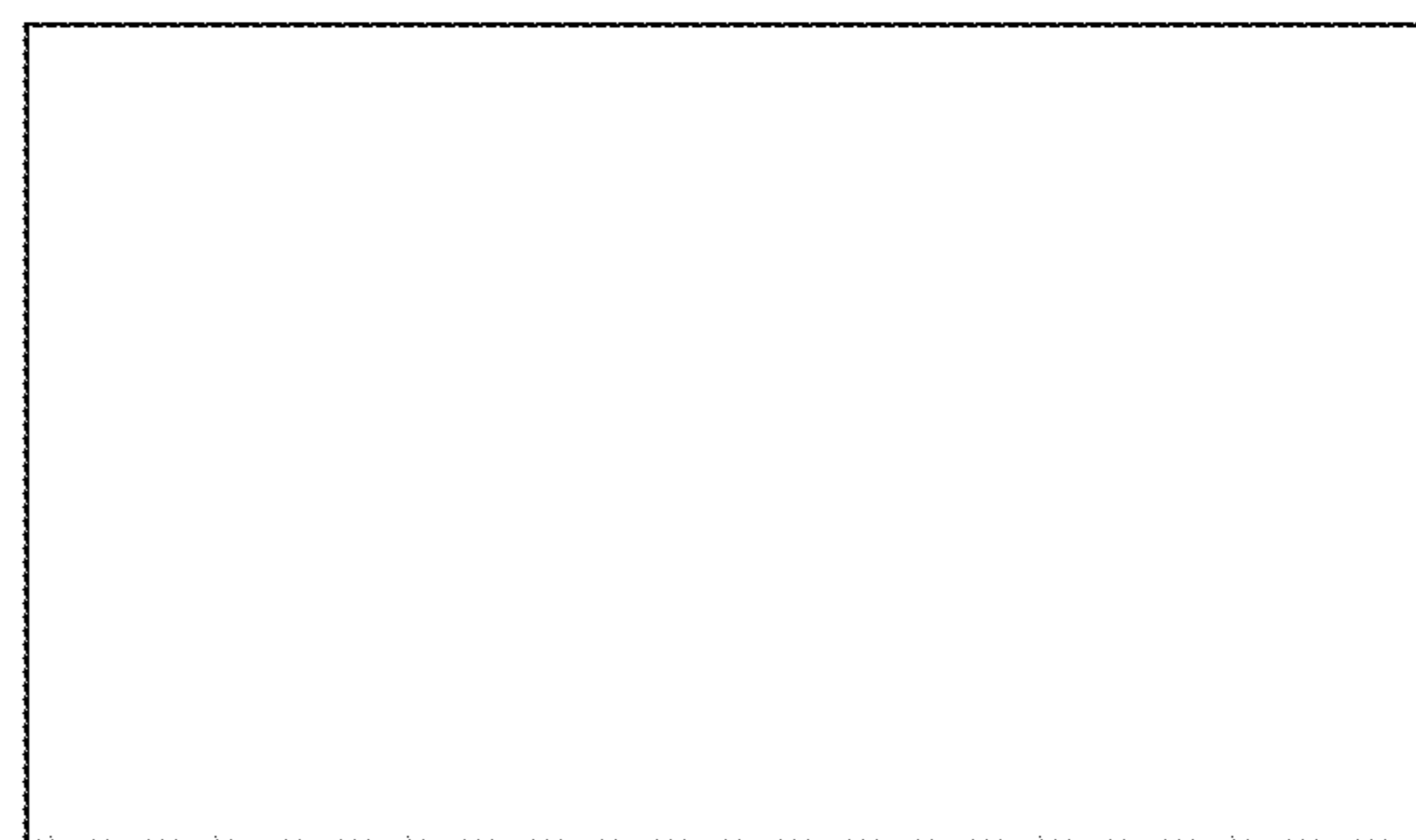

FIG. 56

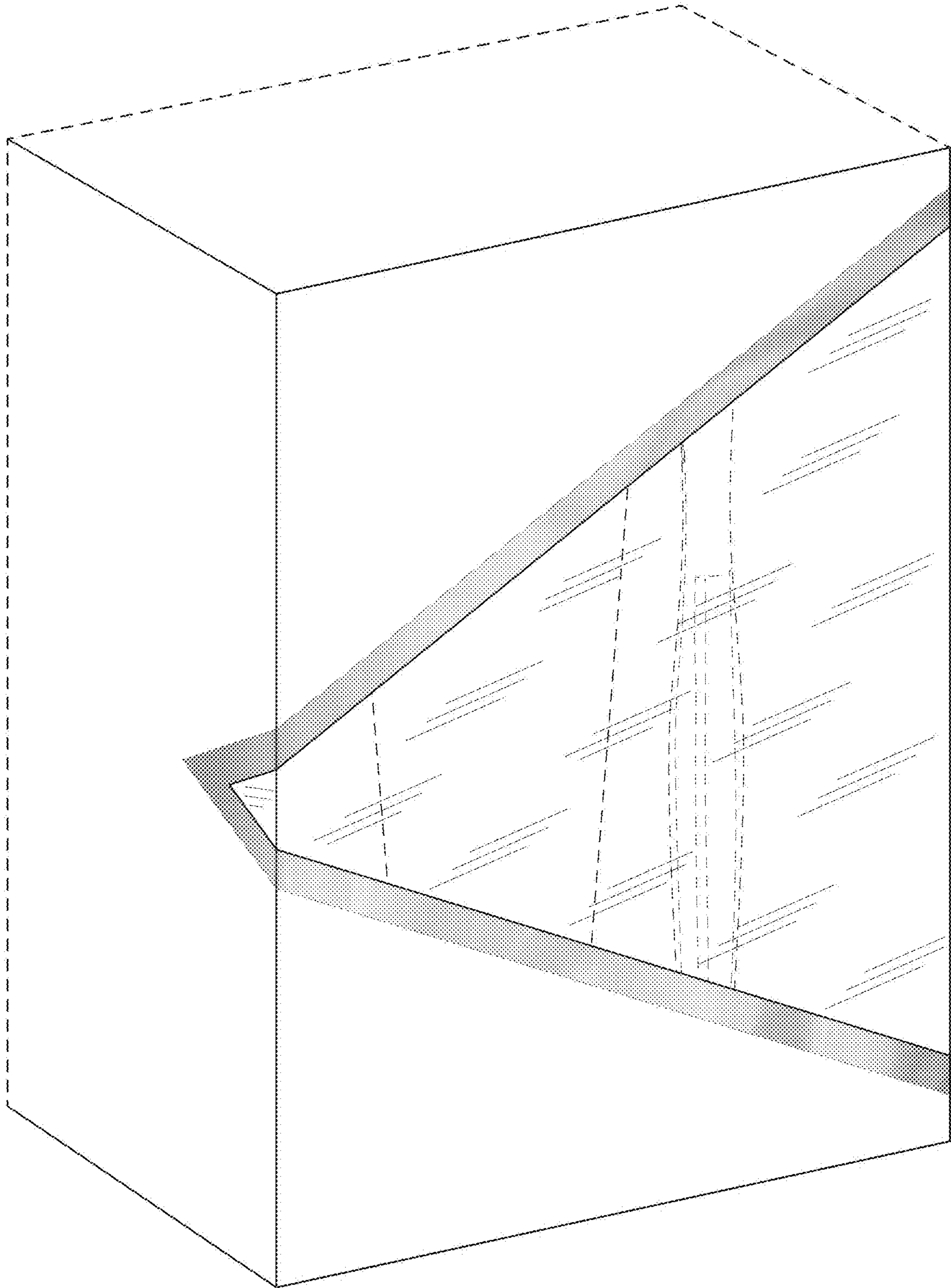

FIG. 57

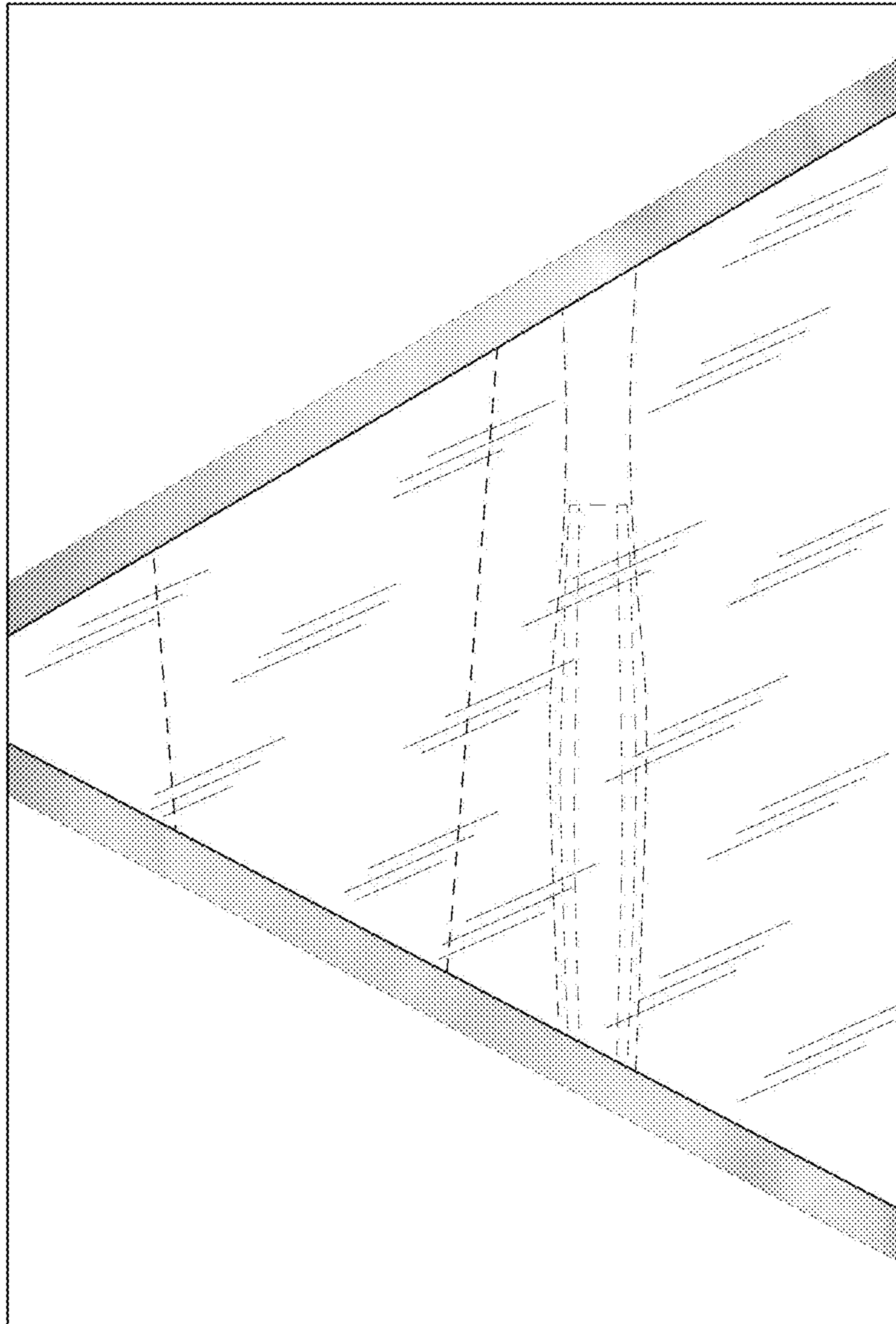

FIG. 58



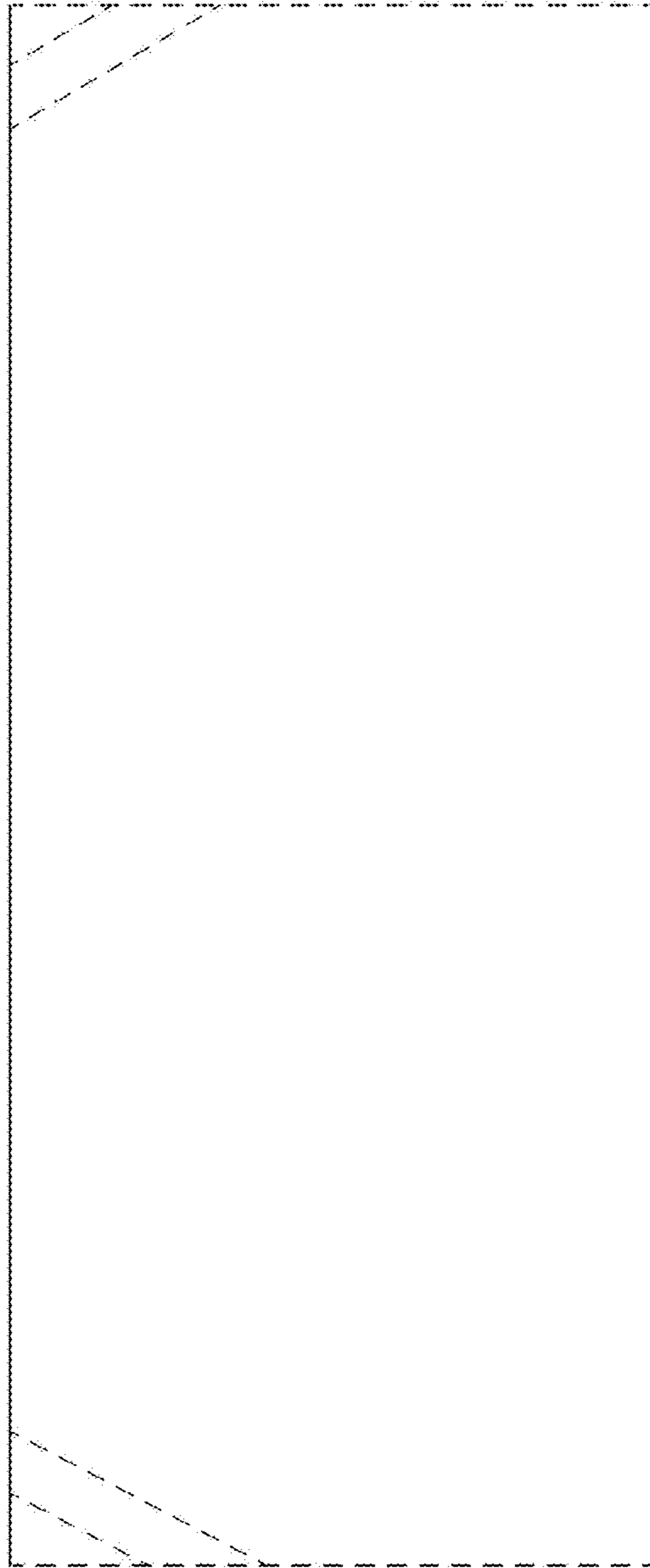

FIG. 59

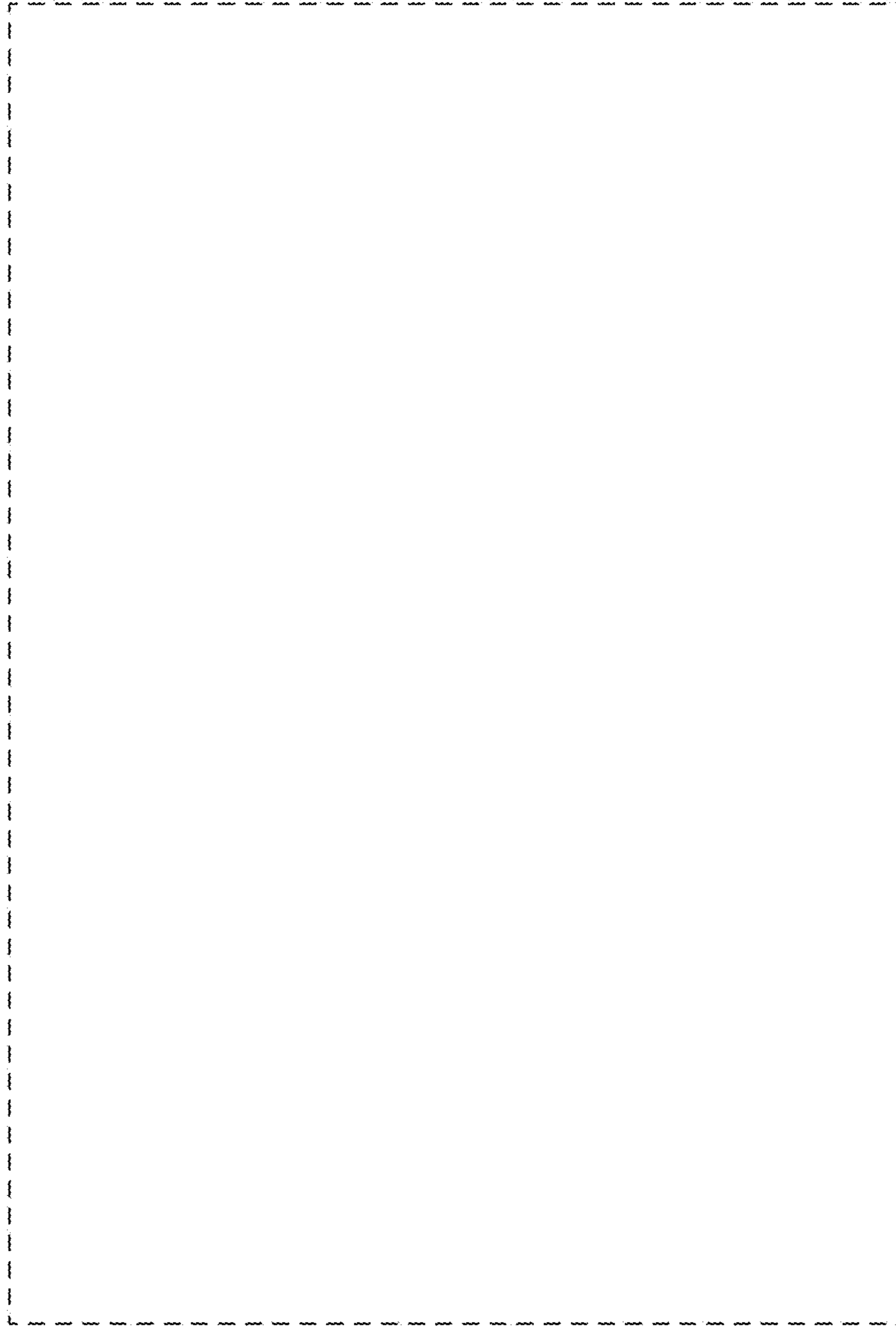

FIG. 60

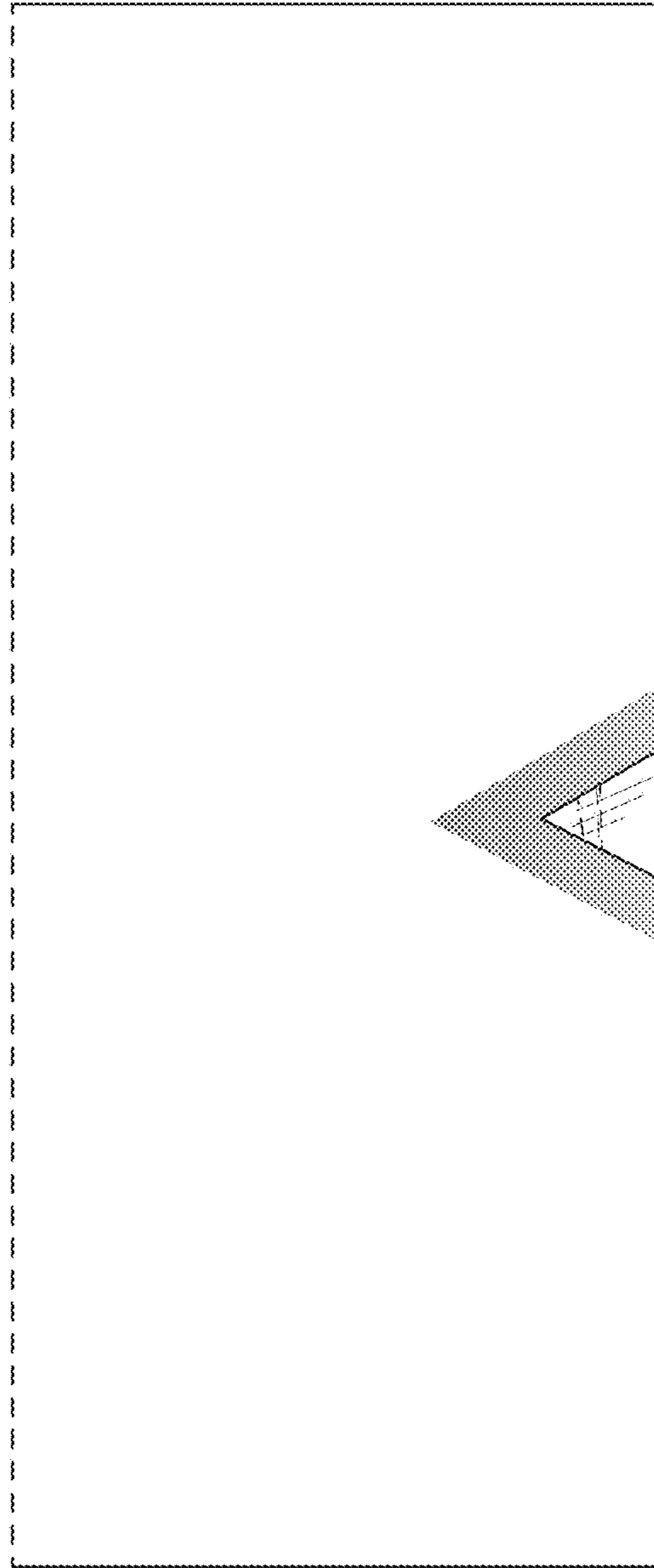

FIG. 61

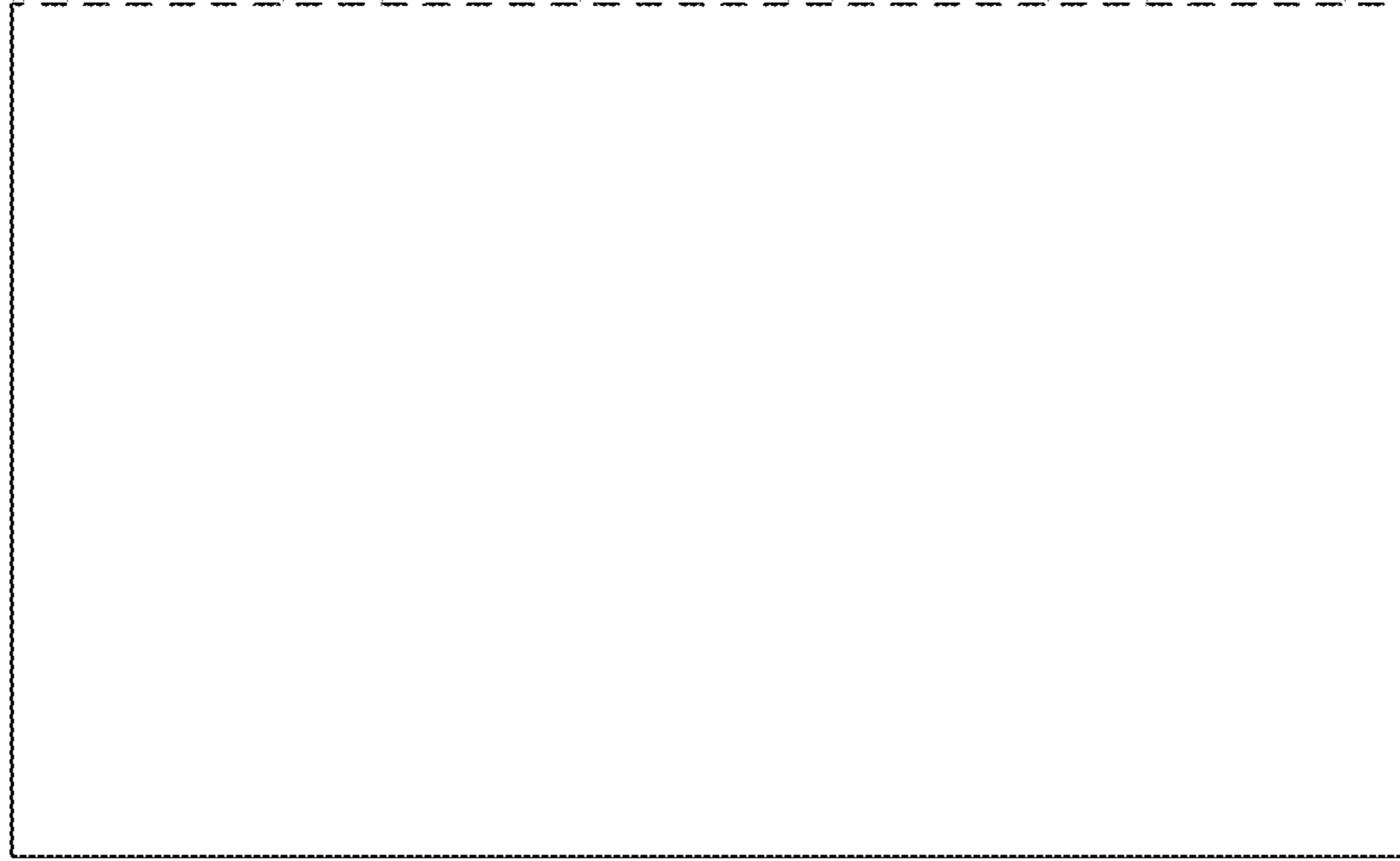

FIG. 62

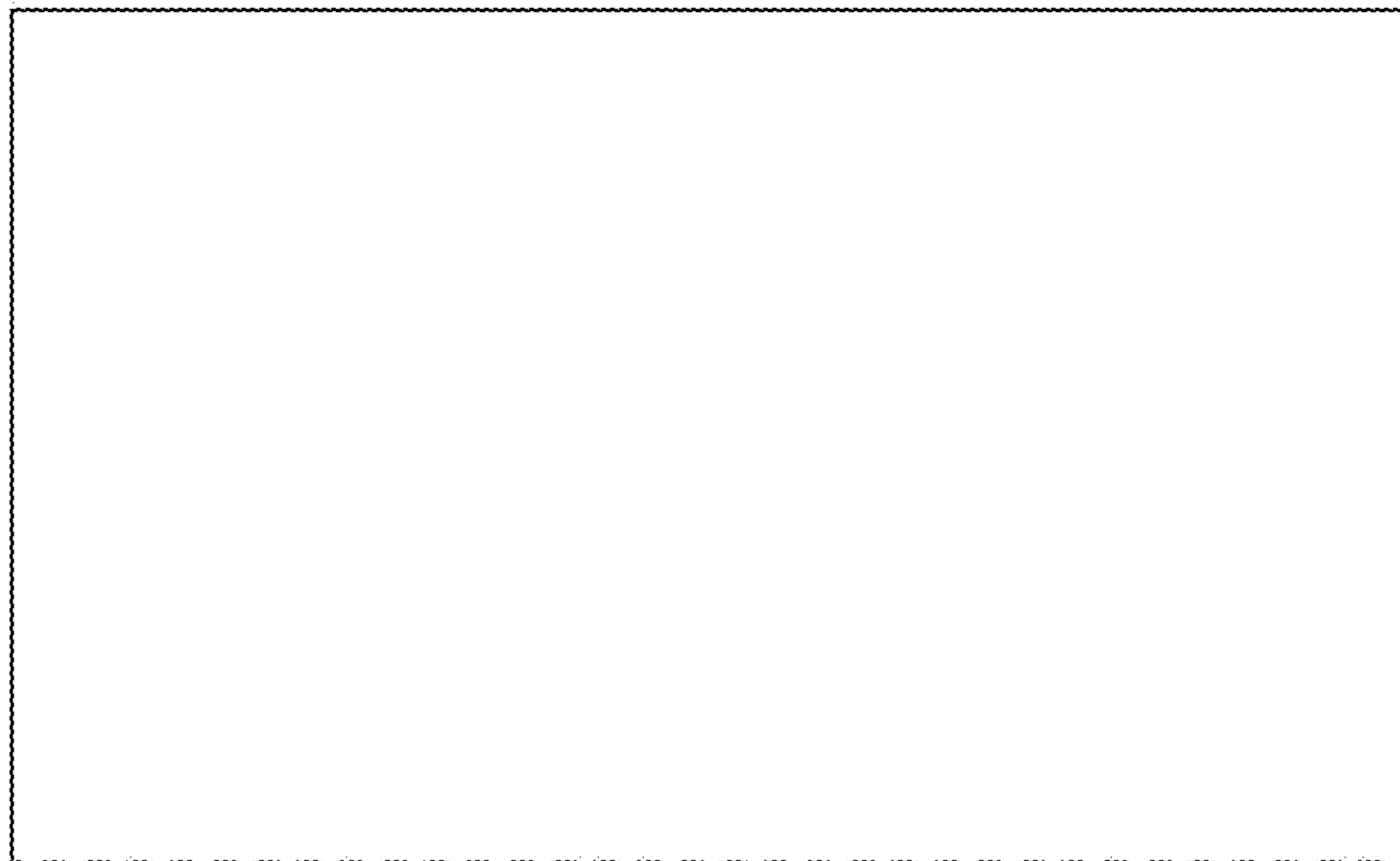

FIG. 63

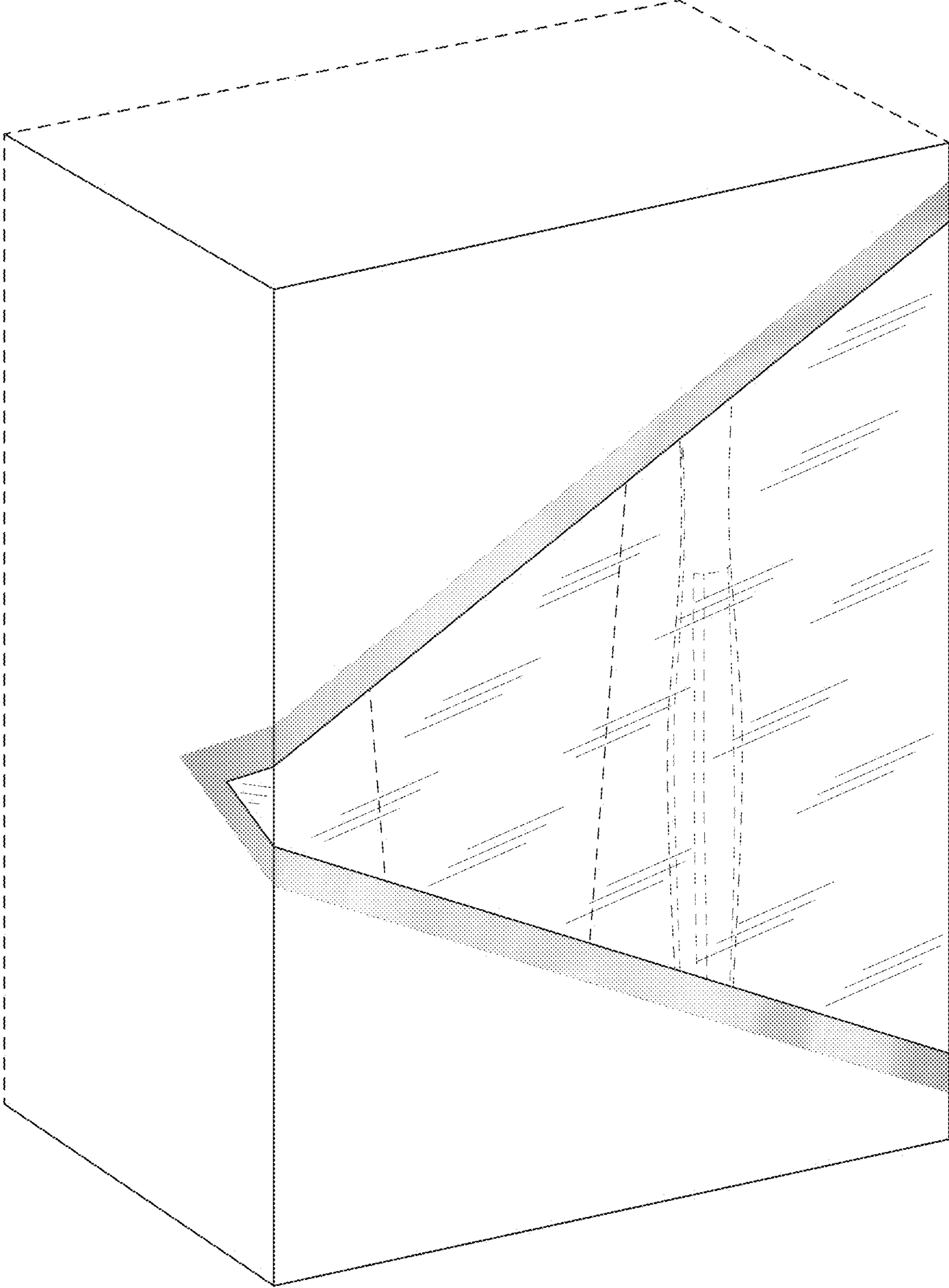

FIG. 64

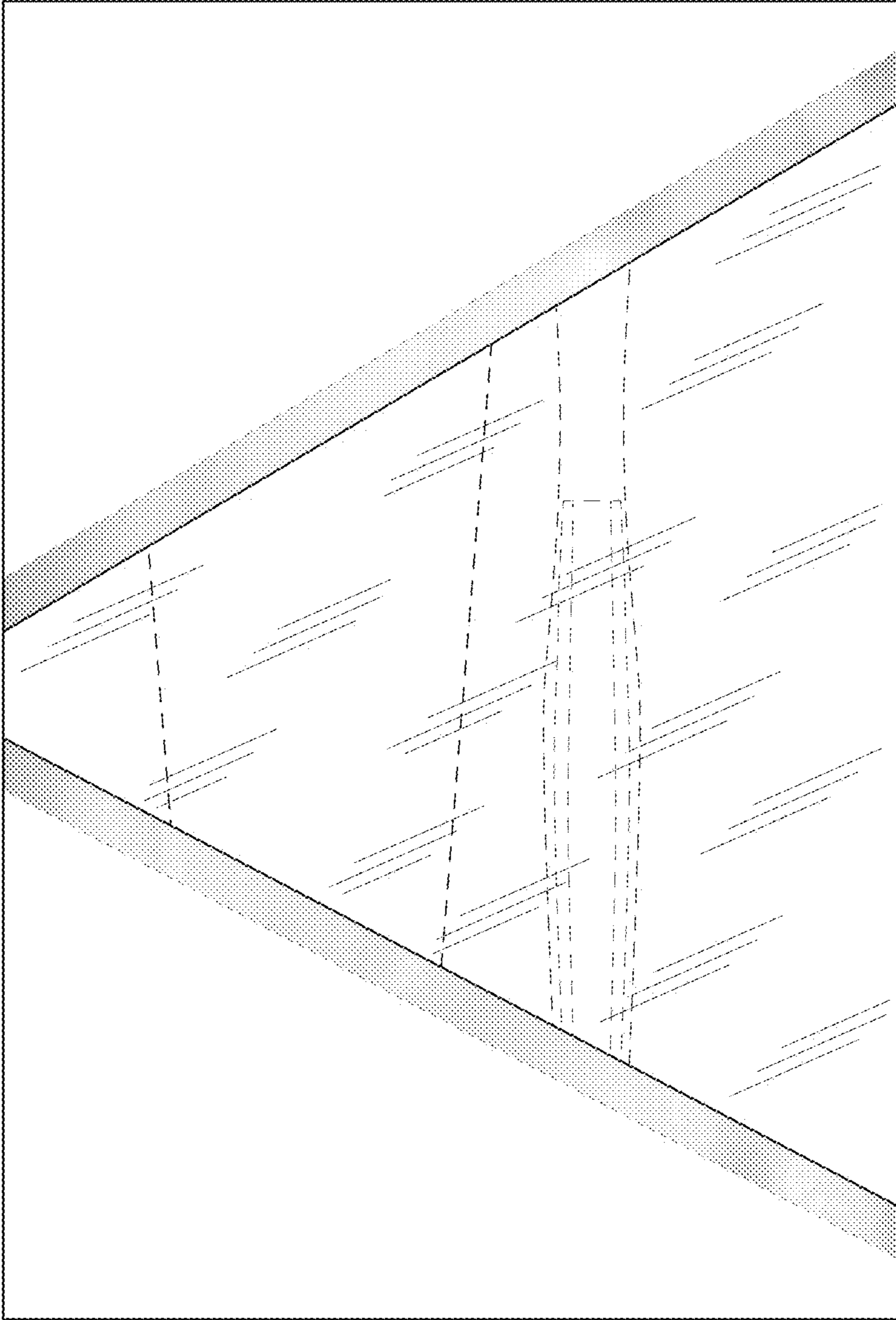

FIG. 65

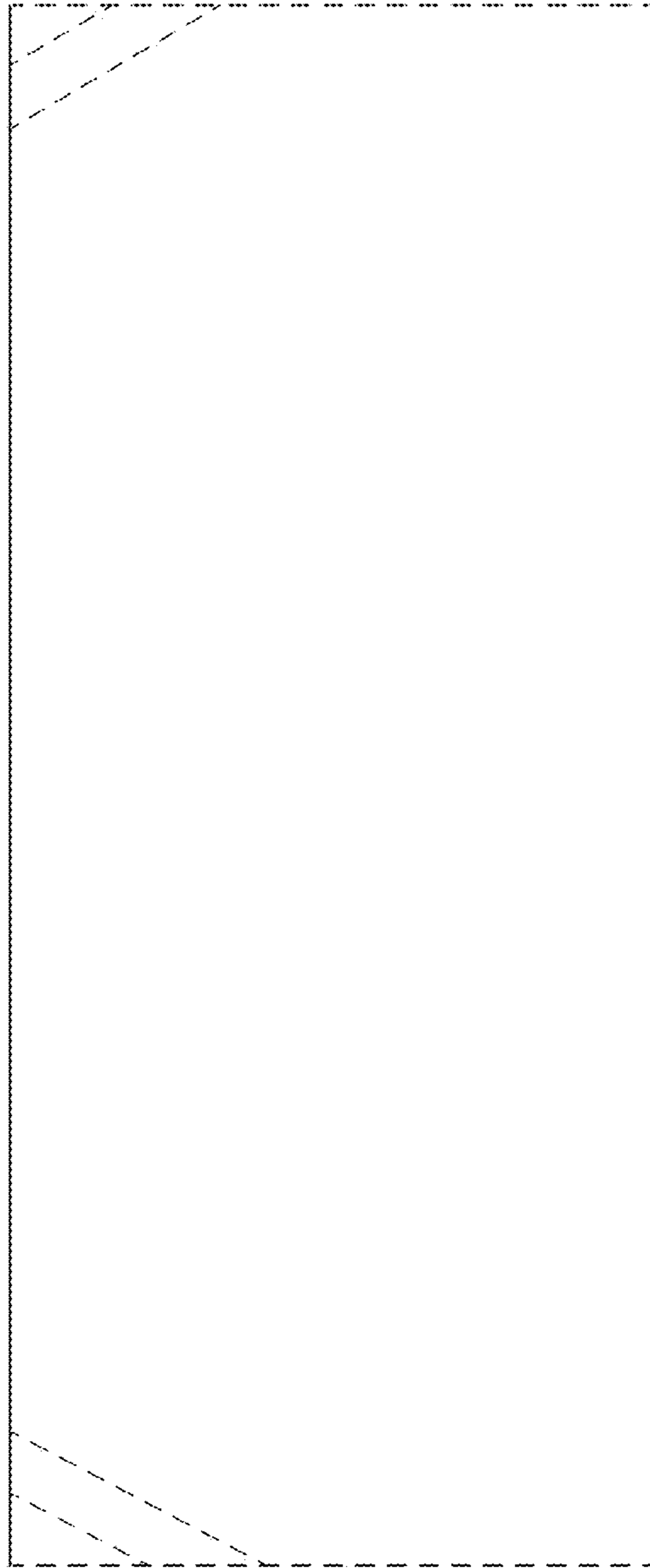

FIG. 66

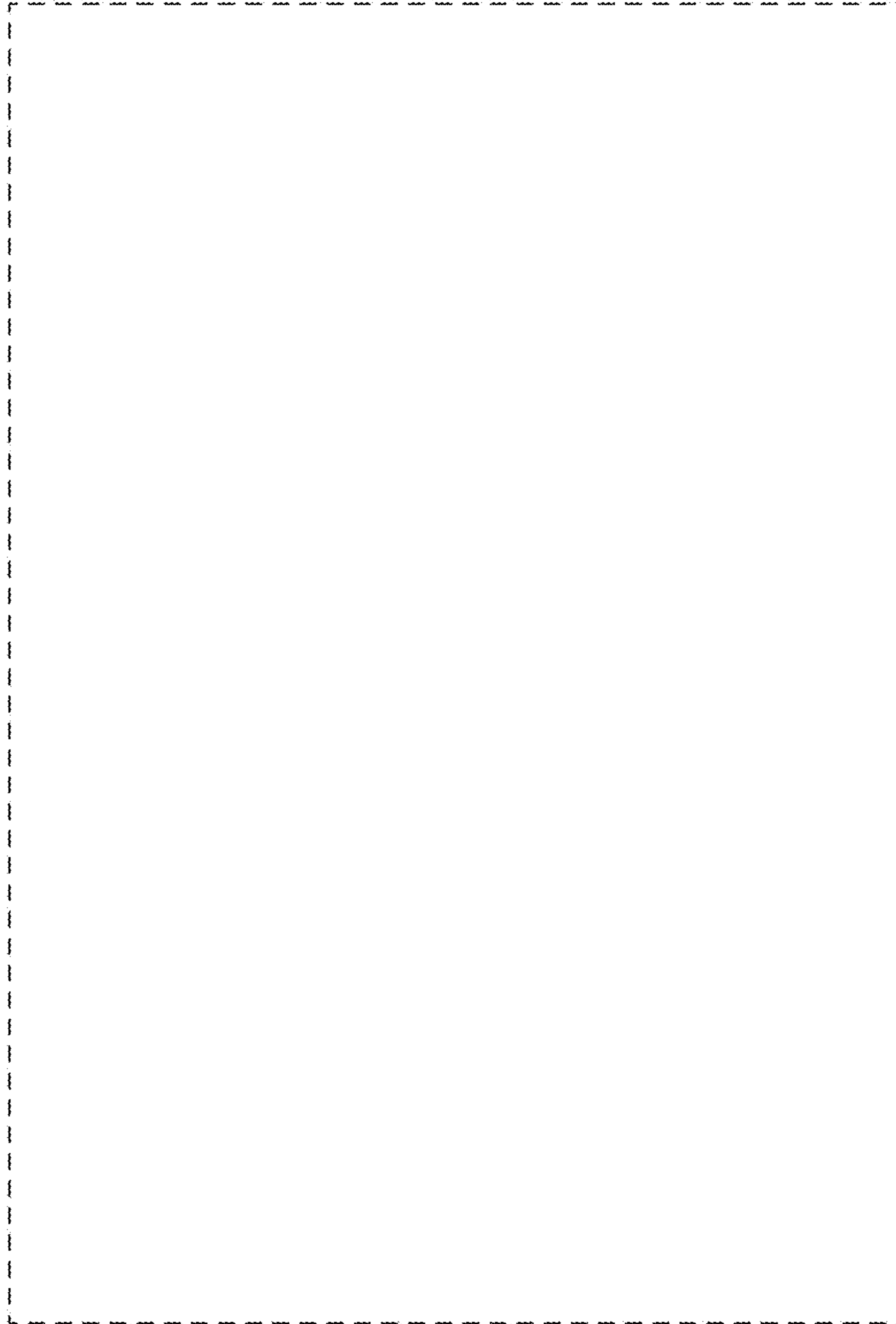

FIG. 67



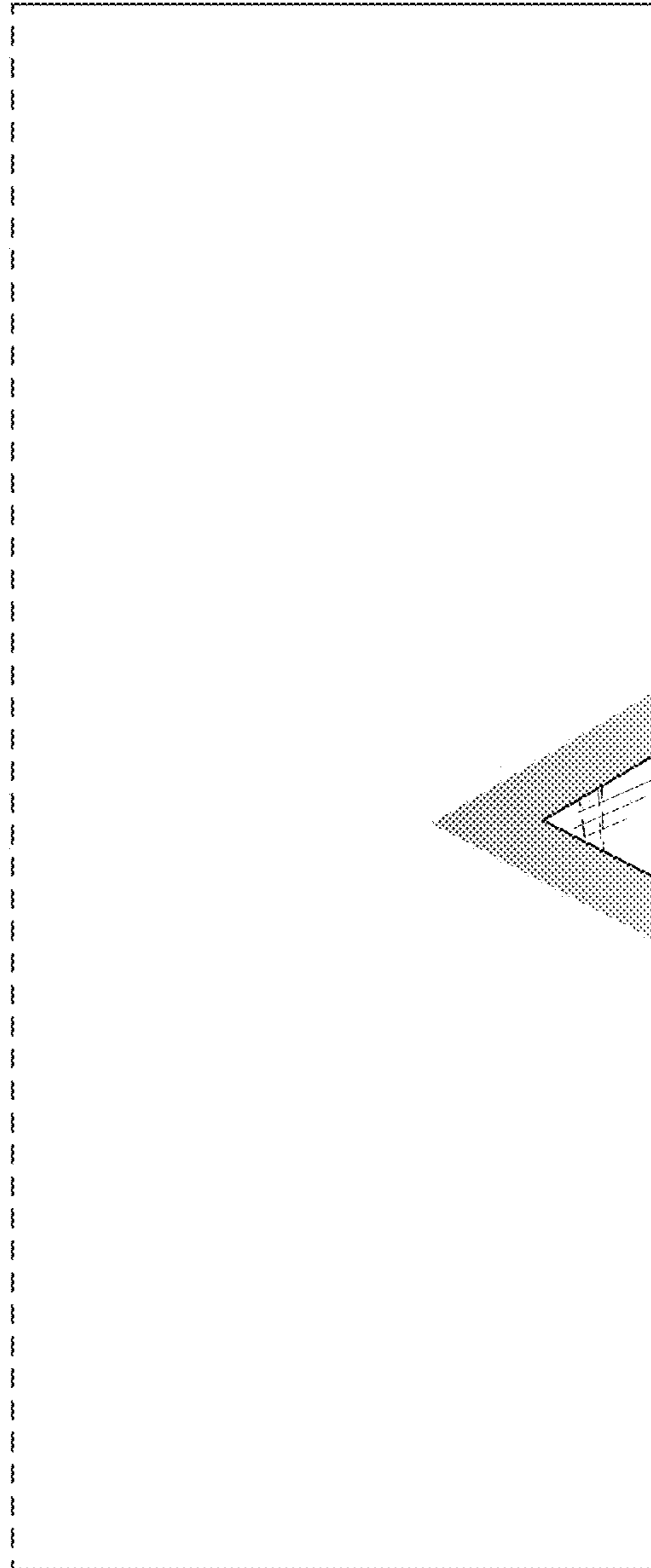

FIG. 68

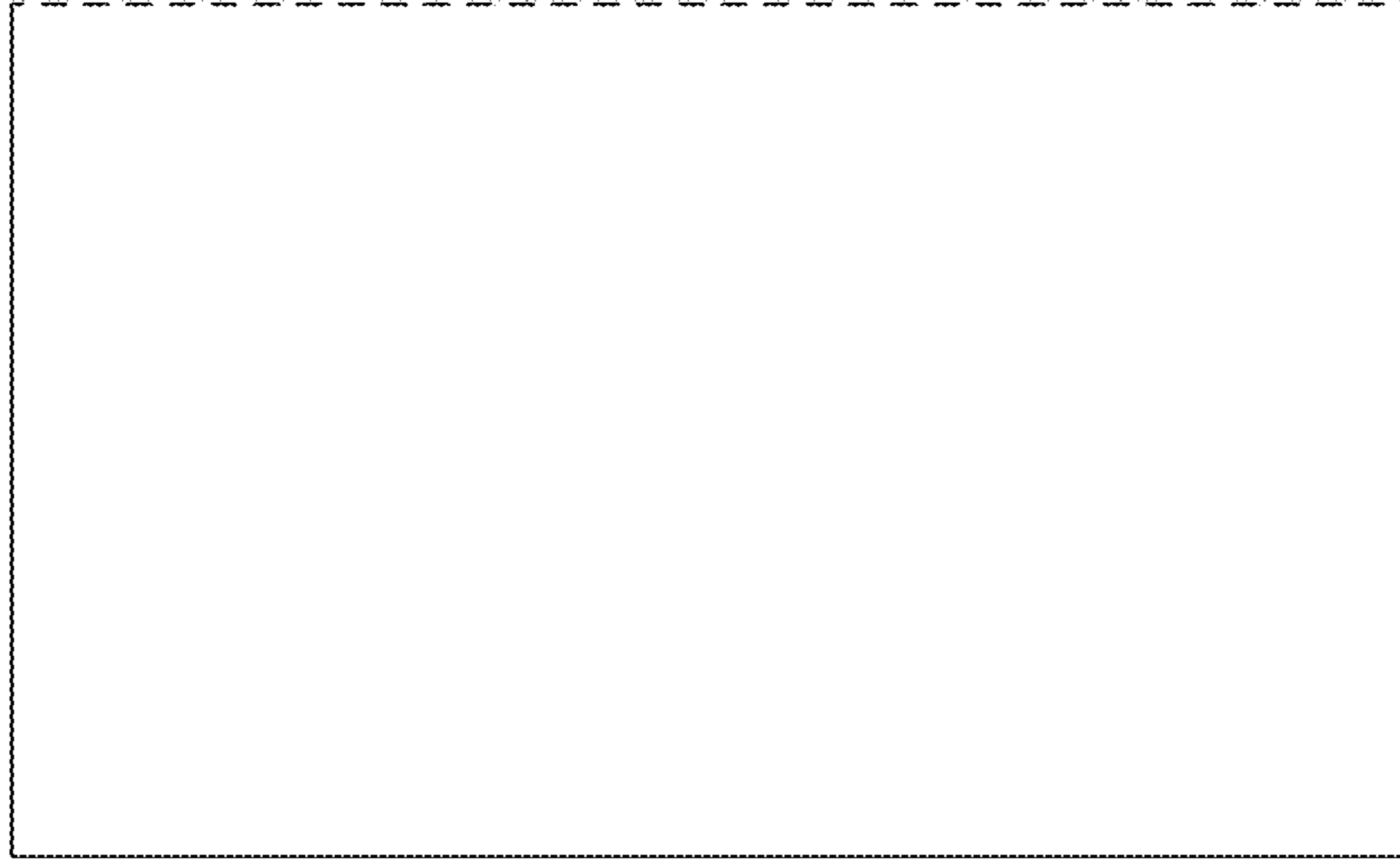

FIG. 69



FIG. 70

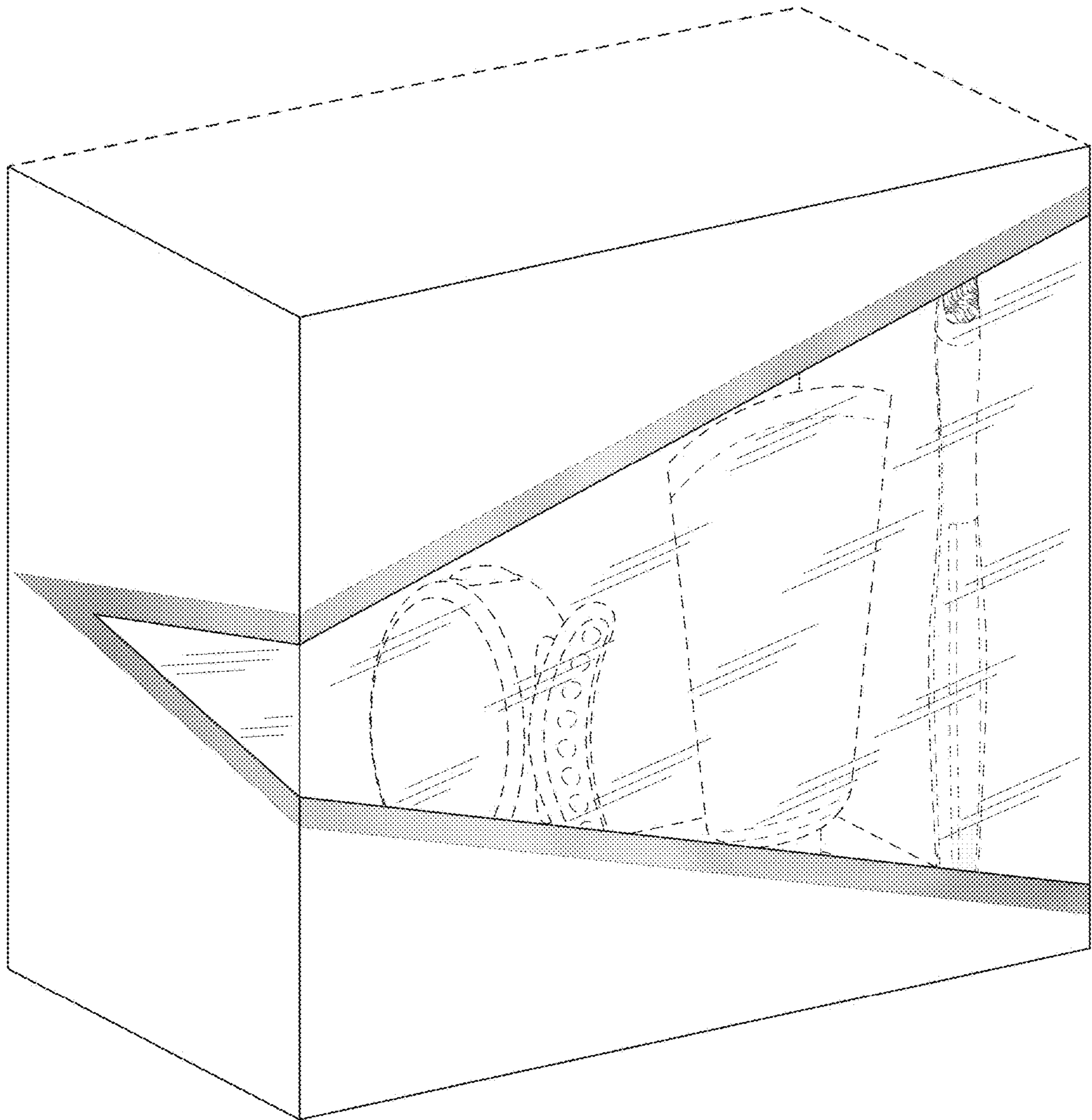

FIG. 71

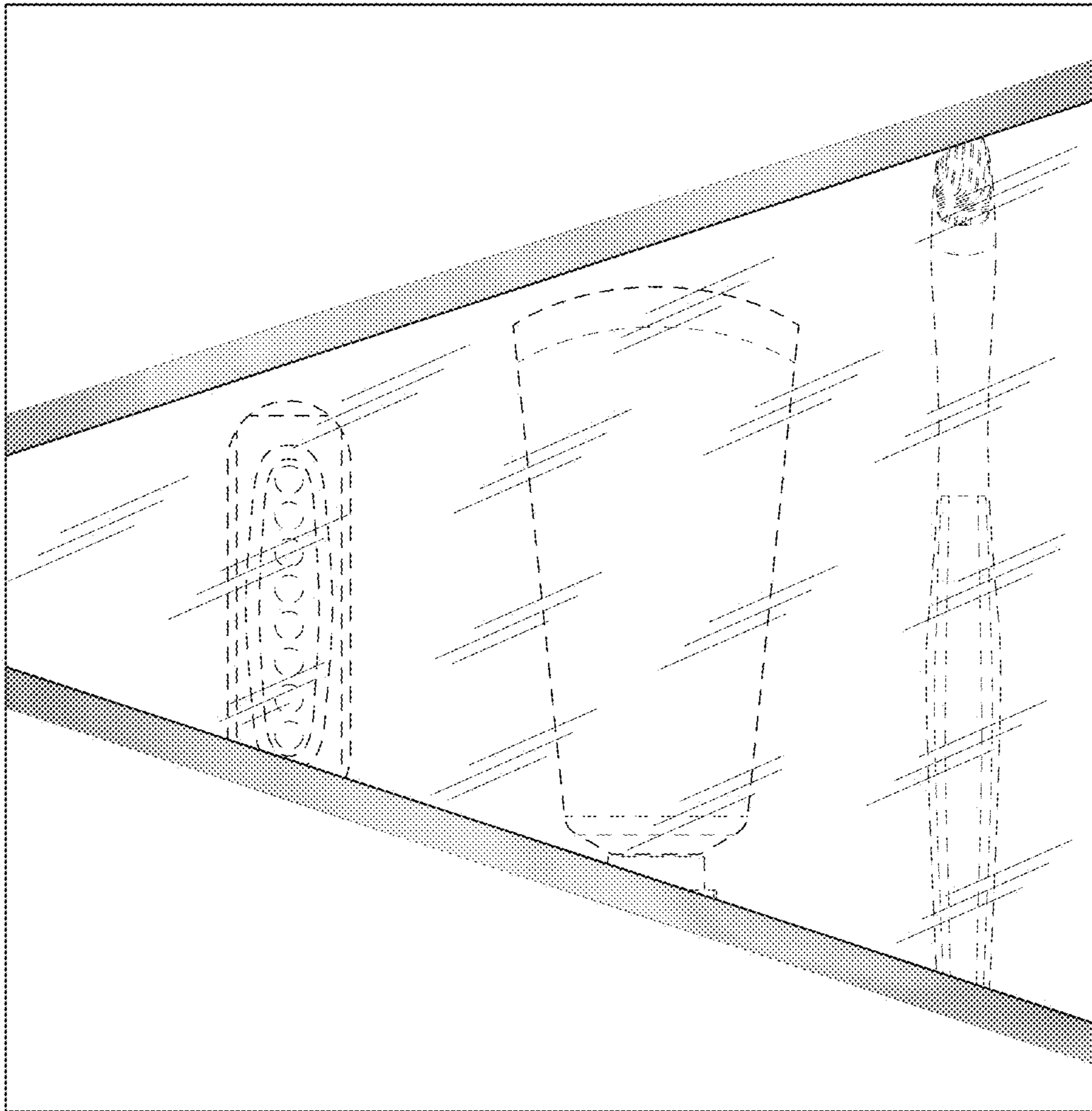

FIG. 72

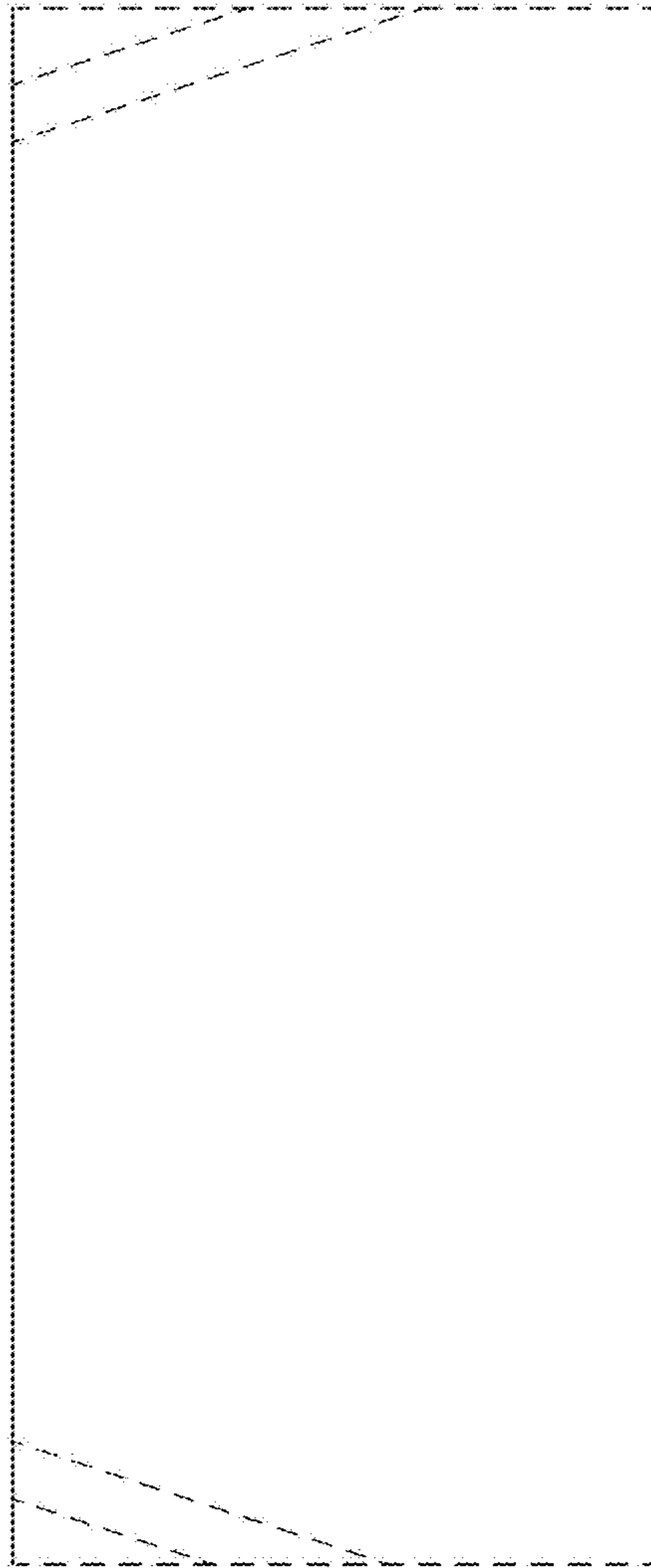

FIG. 73



FIG. 74

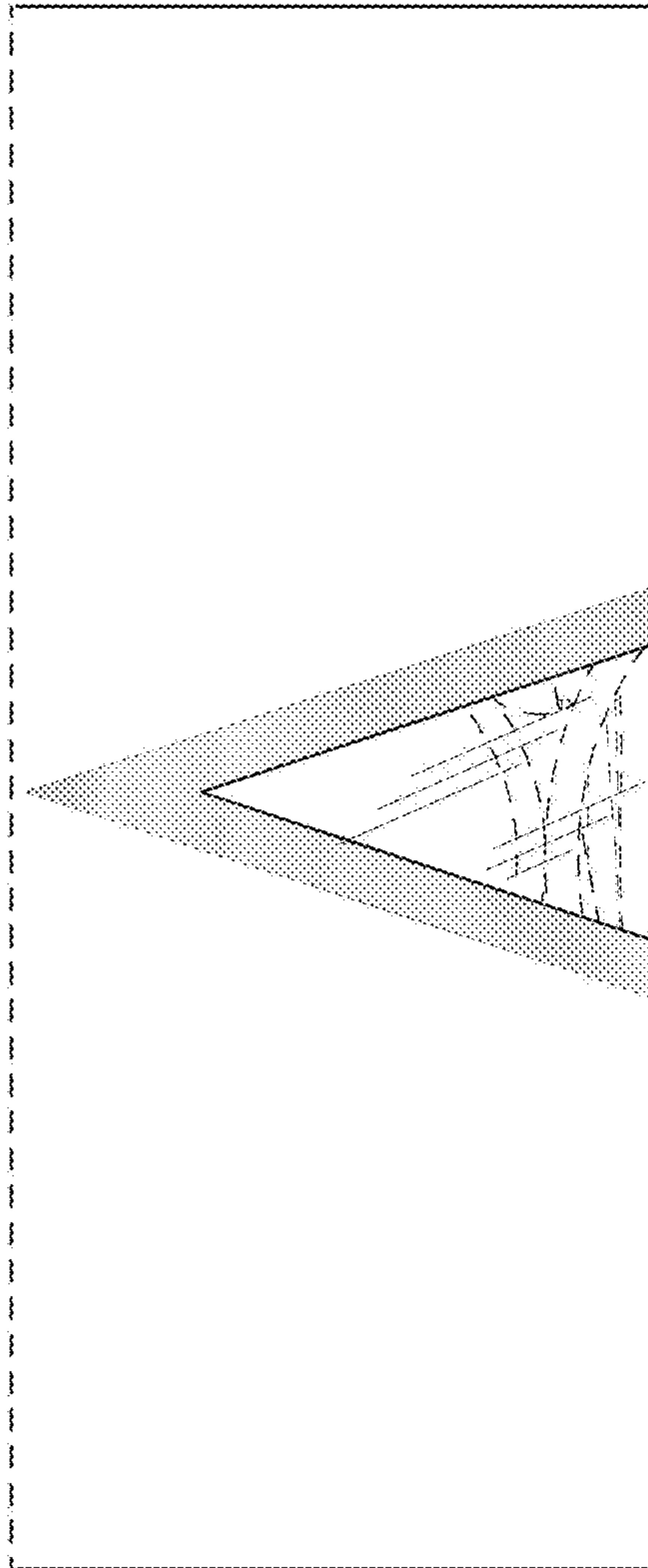

FIG. 75



FIG. 76



FIG. 77



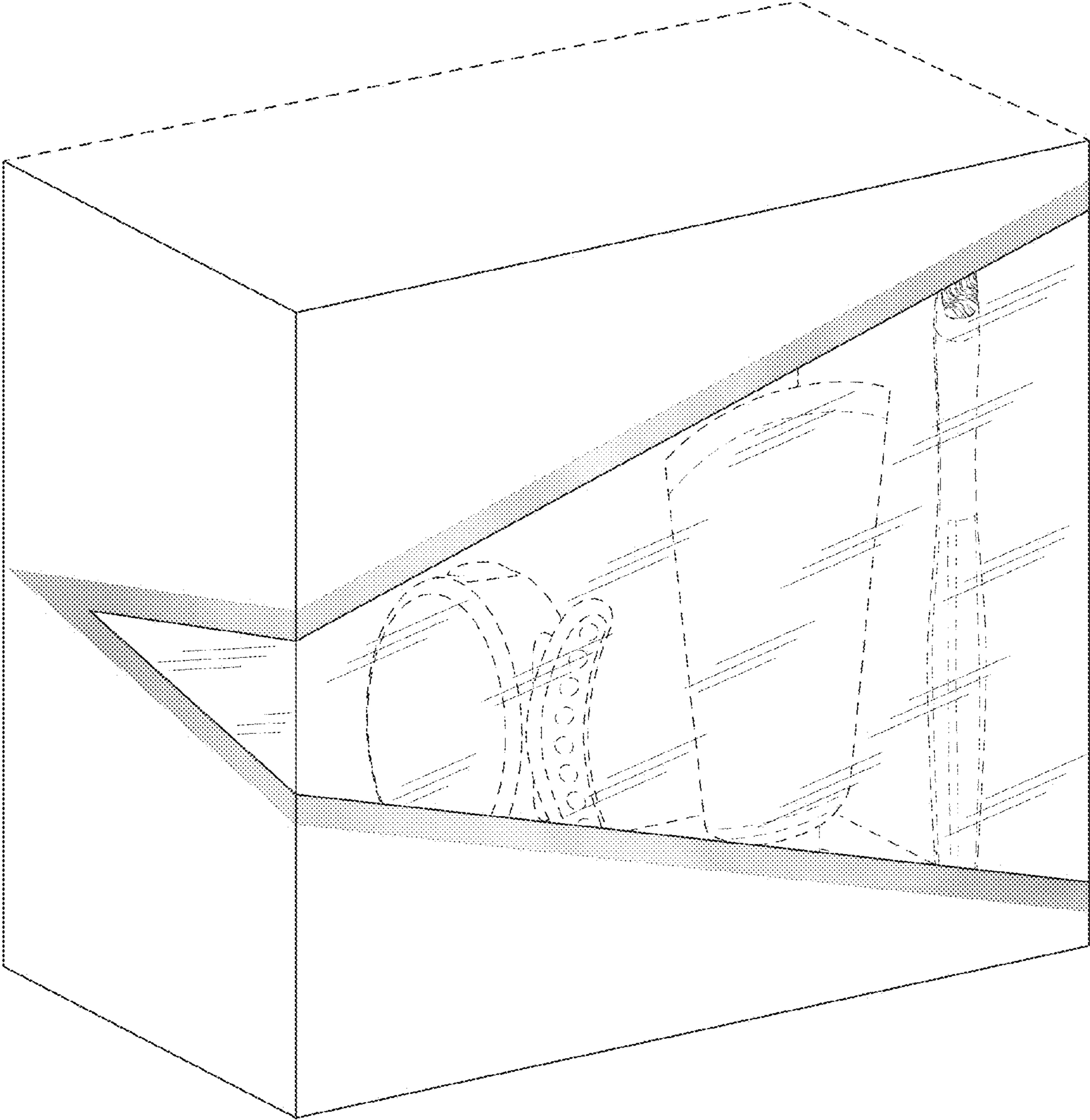

FIG. 78

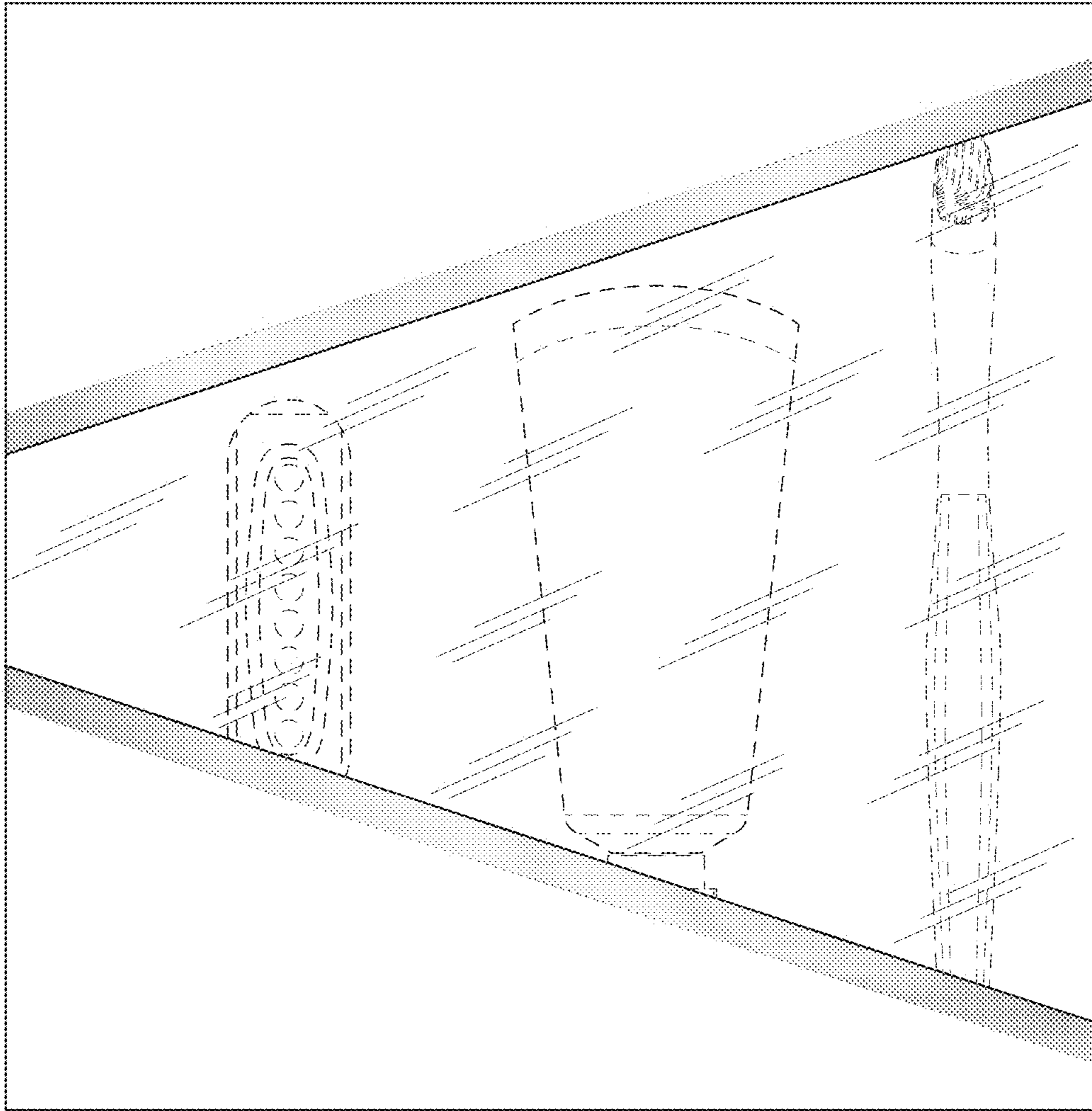

FIG. 79

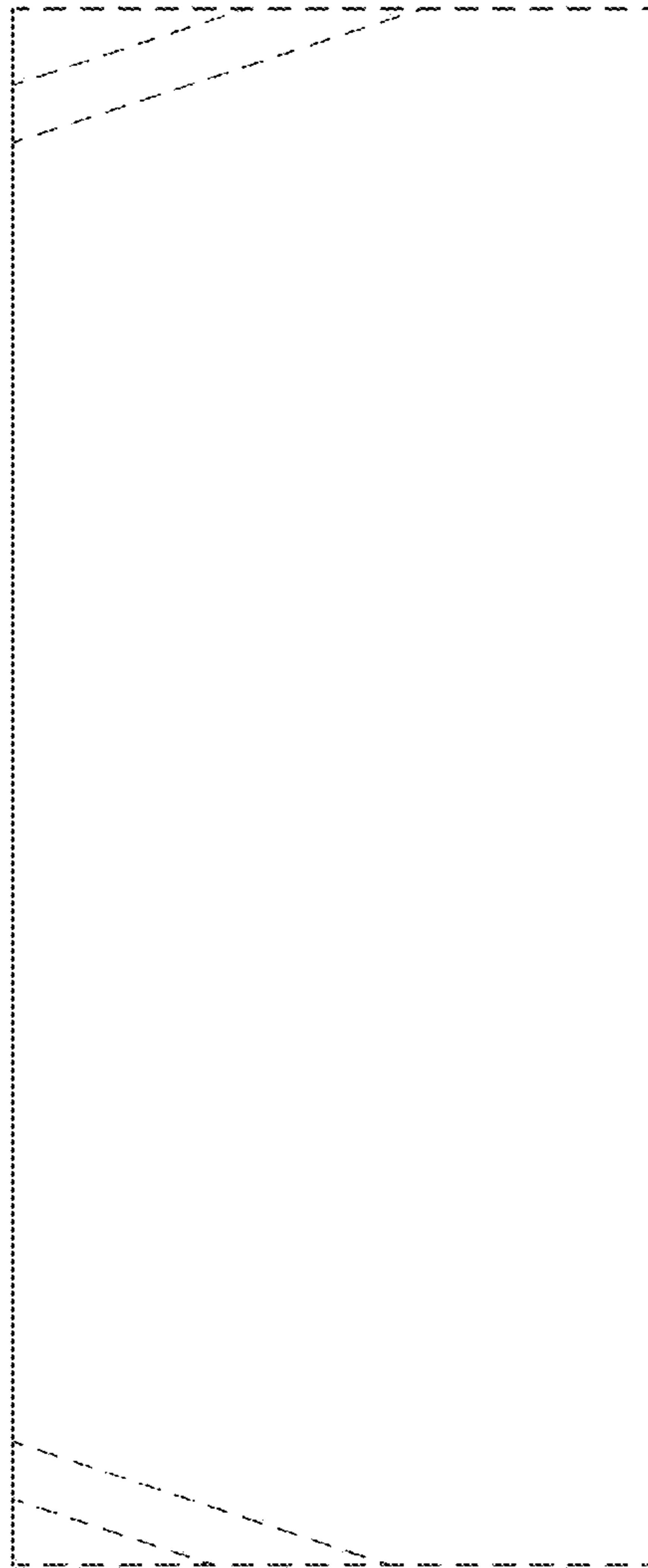

FIG. 80



FIG. 81

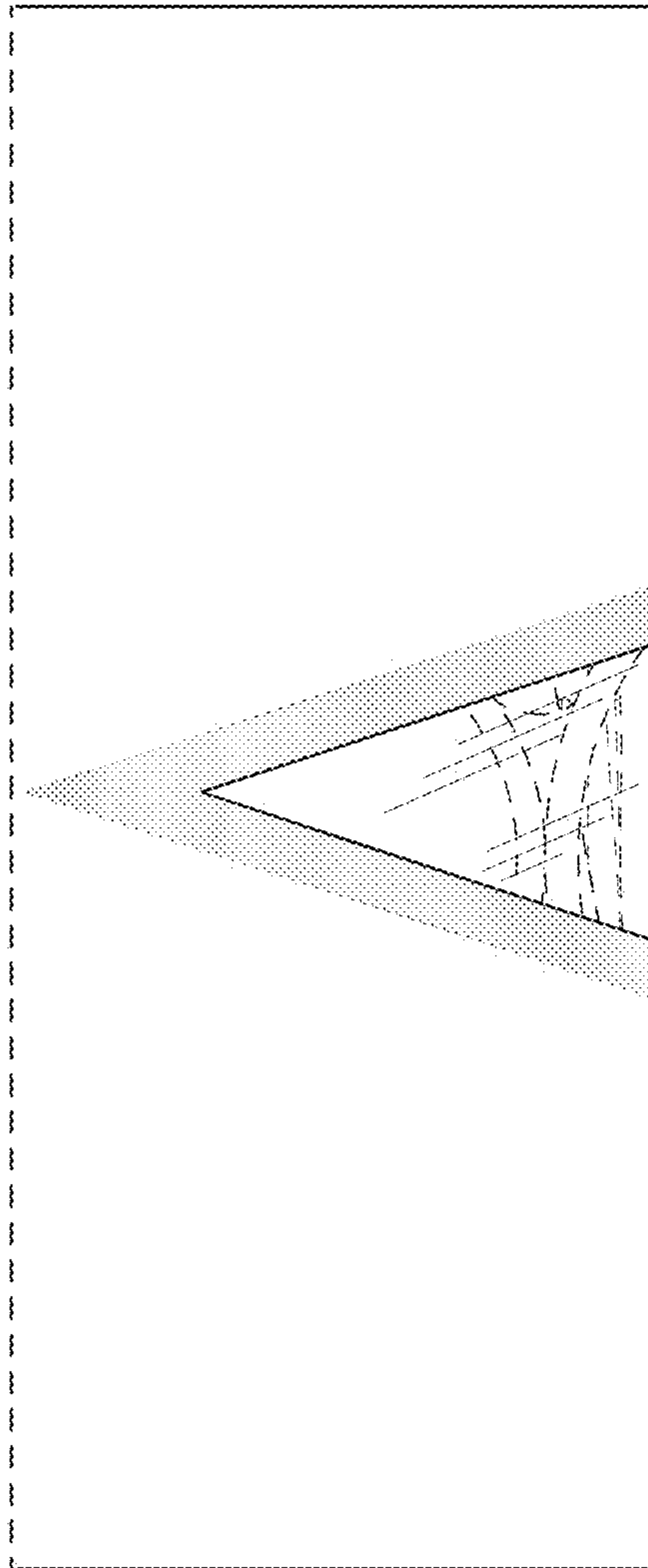

FIG. 82

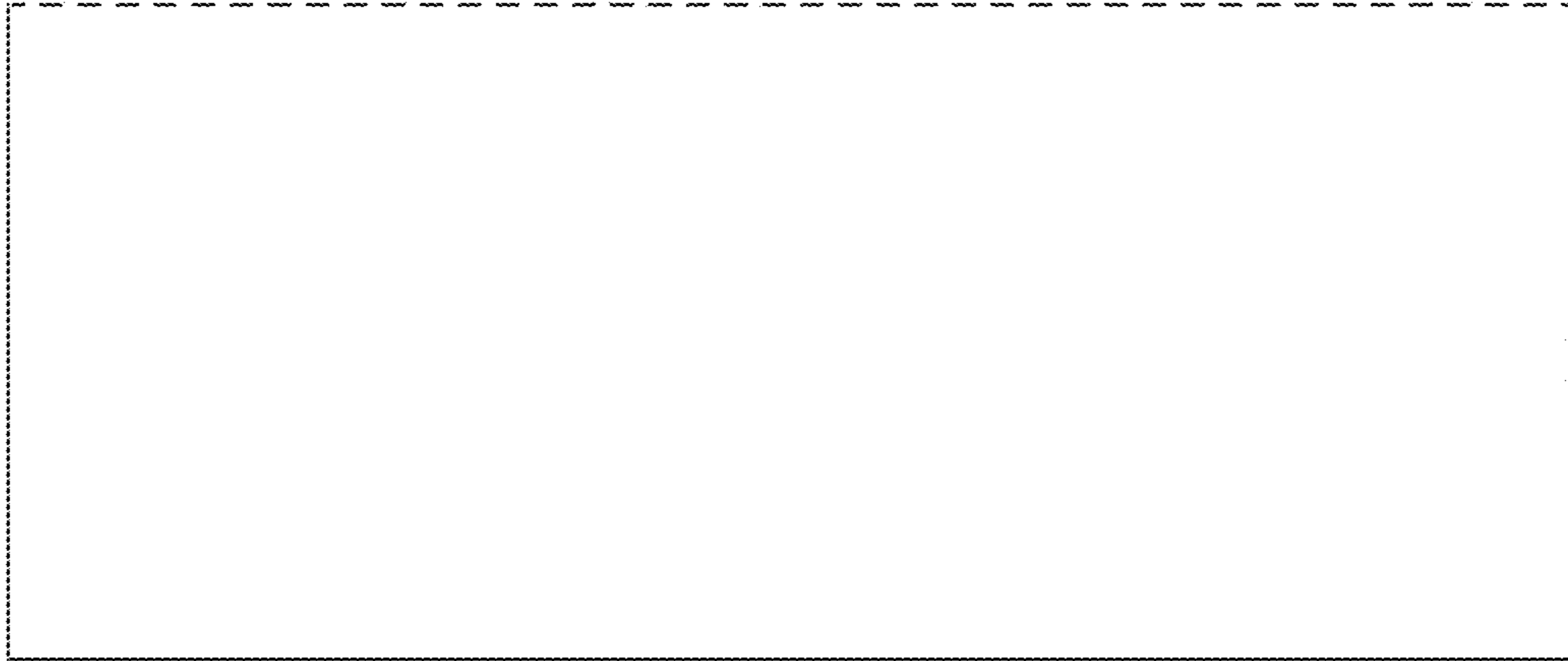

FIG. 83



FIG. 84