



US00D982858S

(12) **United States Design Patent**  
**Dong et al.**

(10) **Patent No.:** **US D982,858 S**  
(45) **Date of Patent:** **\*\* Apr. 4, 2023**

(54) **HANDHELD VACUUM CLEANER**  
(71) Applicant: **Gree Electric Appliances, Inc. of Zhuhai, Zhuhai (CN)**  
(72) Inventors: **Jianbo Dong, Guangdong (CN); Sha Li, Guangdong (CN); Guangyu Chen, Guangdong (CN); Jiachi Liu, Guangdong (CN)**  
(\*\*) Term: **15 Years**  
(21) Appl. No.: **35/510,363**  
(22) Filed: **Aug. 10, 2020**  
(80) **Hague Agreement Data**  
Int. Filing Date: **Aug. 10, 2020**  
Int. Reg. No.: **DM/210219**  
Int. Reg. Date: **Aug. 10, 2020**  
Int. Reg. Pub. Date: **Sep. 18, 2020**

(30) **Foreign Application Priority Data**  
Mar. 27, 2020 (CN) ..... 202030112823.X  
(51) **LOC (14) Cl.** ..... **15-05**  
(52) **U.S. Cl.**  
USPC ..... **D32/21**  
(58) **Field of Classification Search**  
USPC ... D32/4, 17, 18, 19, 21, 22, 23, 24, 31, 32, D32/34, 38, 39  
CPC ... A47L 5/24; A47L 5/28; A47L 5/225; A47L 9/12; A47L 9/322; A47L 9/1608; A47L 9/1683  
See application file for complete search history.

(56) **References Cited**  
U.S. PATENT DOCUMENTS  
D668,010 S \* 9/2012 Stickney ..... D32/18  
D830,016 S \* 10/2018 Lim ..... D32/22

D830,017 S \* 10/2018 Nam ..... D32/22  
D839,509 S \* 1/2019 Nam ..... D32/18  
D839,510 S \* 1/2019 Nam ..... D32/18  
D905,360 S \* 12/2020 Ma ..... D32/22  
D908,990 S \* 1/2021 Chen ..... D32/22  
D912,344 S \* 3/2021 Choi ..... D32/21  
D915,697 S \* 4/2021 Kim ..... B01D 46/0023  
D32/18  
D918,504 S \* 5/2021 Kim ..... D32/31  
D920,609 S \* 5/2021 Ma ..... D32/21  
D927,103 S \* 8/2021 Zou ..... D32/18  
D932,124 S \* 9/2021 Lin ..... D32/22  
D946,221 S \* 3/2022 Ma ..... D32/18  
D947,472 S \* 3/2022 He ..... D32/18  
D948,142 S \* 4/2022 He ..... D32/18  
2020/0214523 A1 \* 7/2020 Kim ..... A47L 5/24  
2021/0121033 A1 \* 4/2021 Kwak ..... A47L 9/281  
2022/0022711 A1 \* 1/2022 Lee ..... A47L 9/242

\* cited by examiner

*Primary Examiner* — Tracey J Bell

(57) **CLAIM**

The ornamental design for a handheld vacuum cleaner, as shown and described.

**DESCRIPTION**

- 1. Handheld vacuum cleaner
- 1.1 : Front
- 1.2 : Back
- 1.3 : Left
- 1.4 : Right
- 1.5 : Top
- 1.6 : Bottom
- 1.7 : Perspective

Portions within the broken lines in Fig. 1.2 show environment and form no part of the claimed design.

**1 Claim, 7 Drawing Sheets**

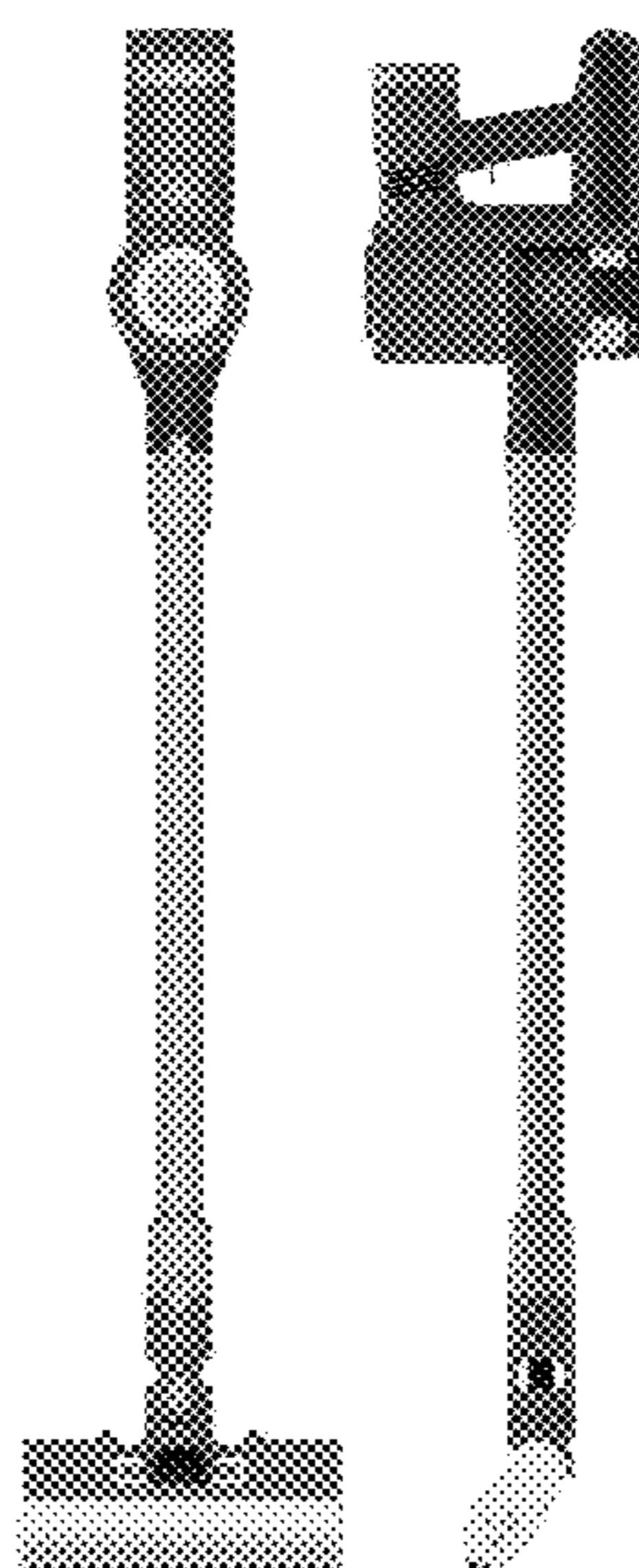

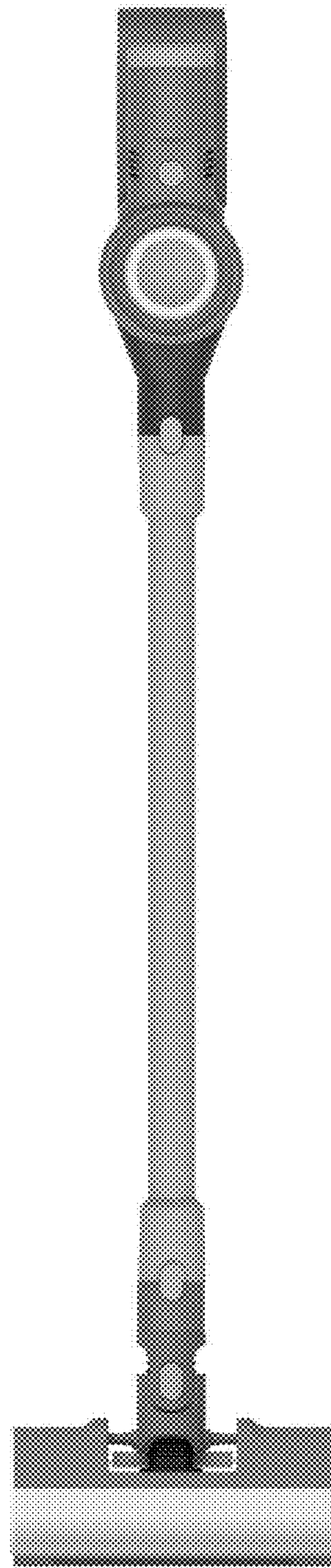

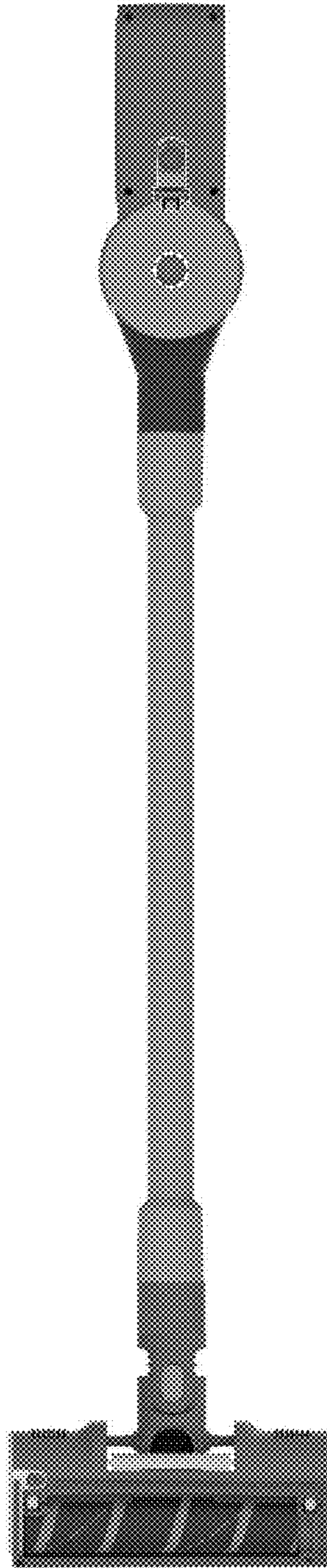

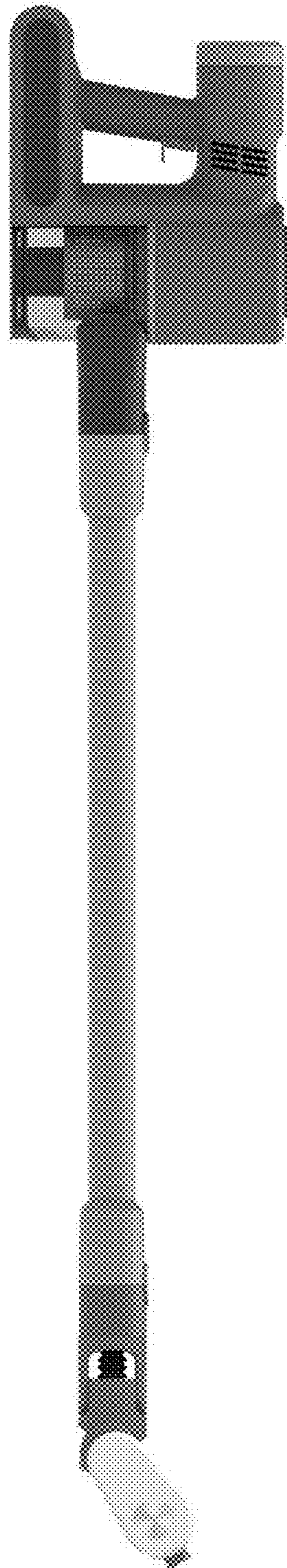

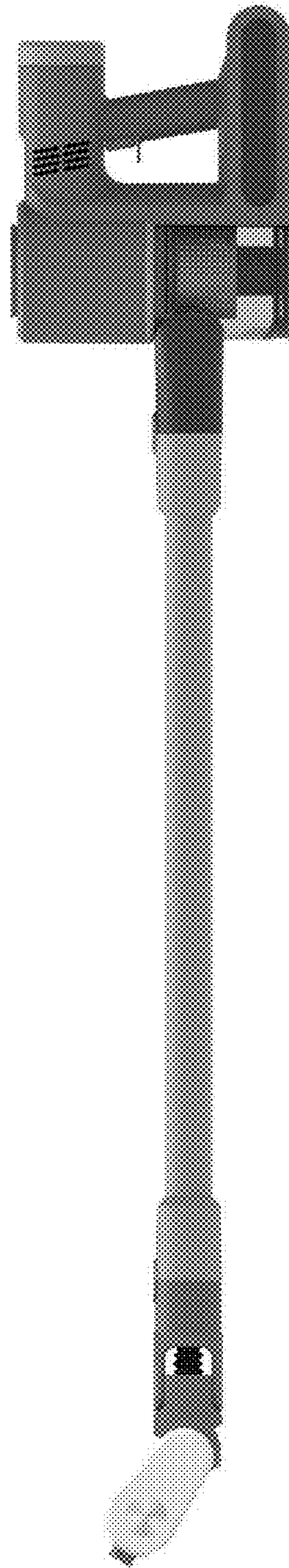

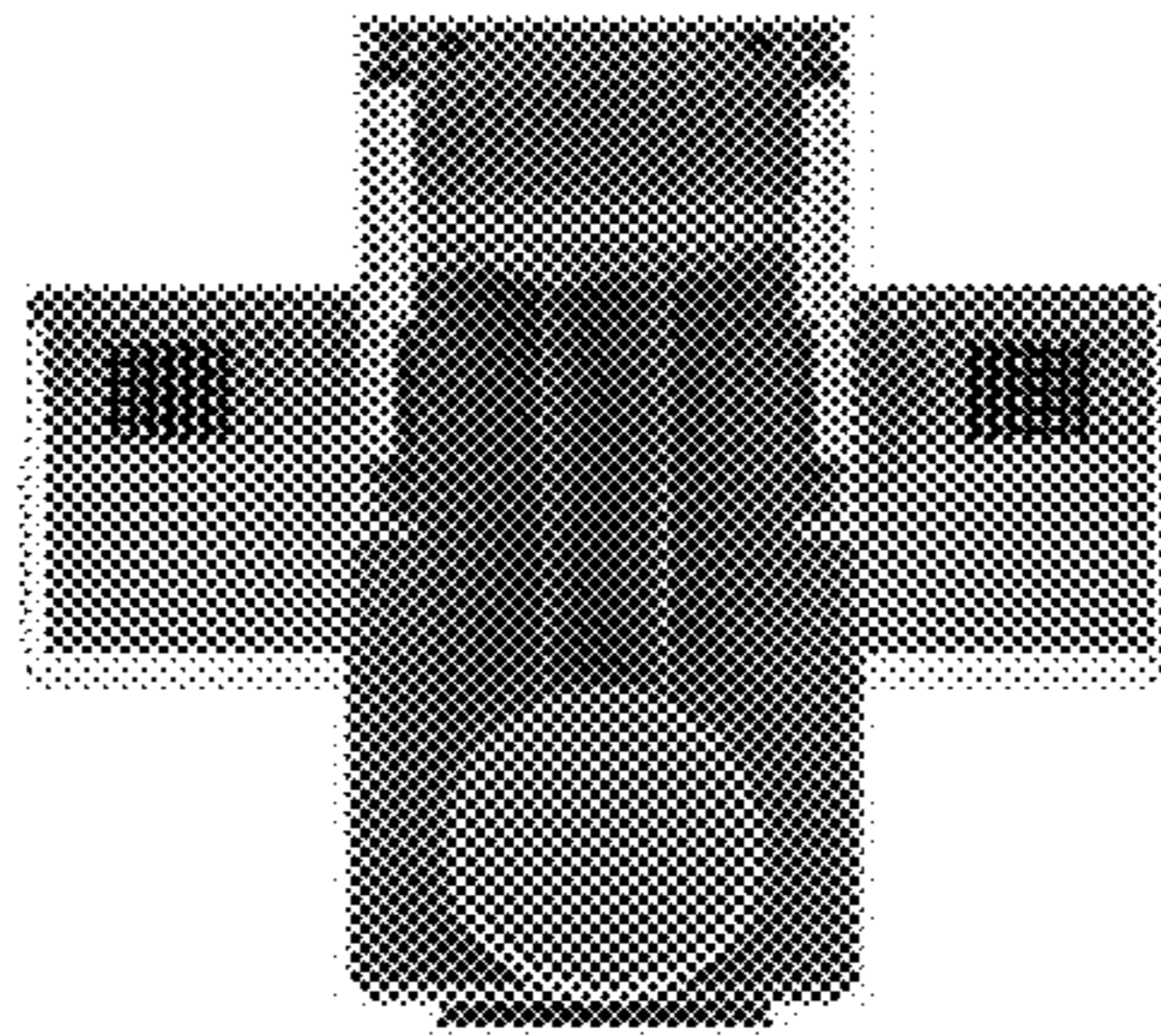

**1.5**

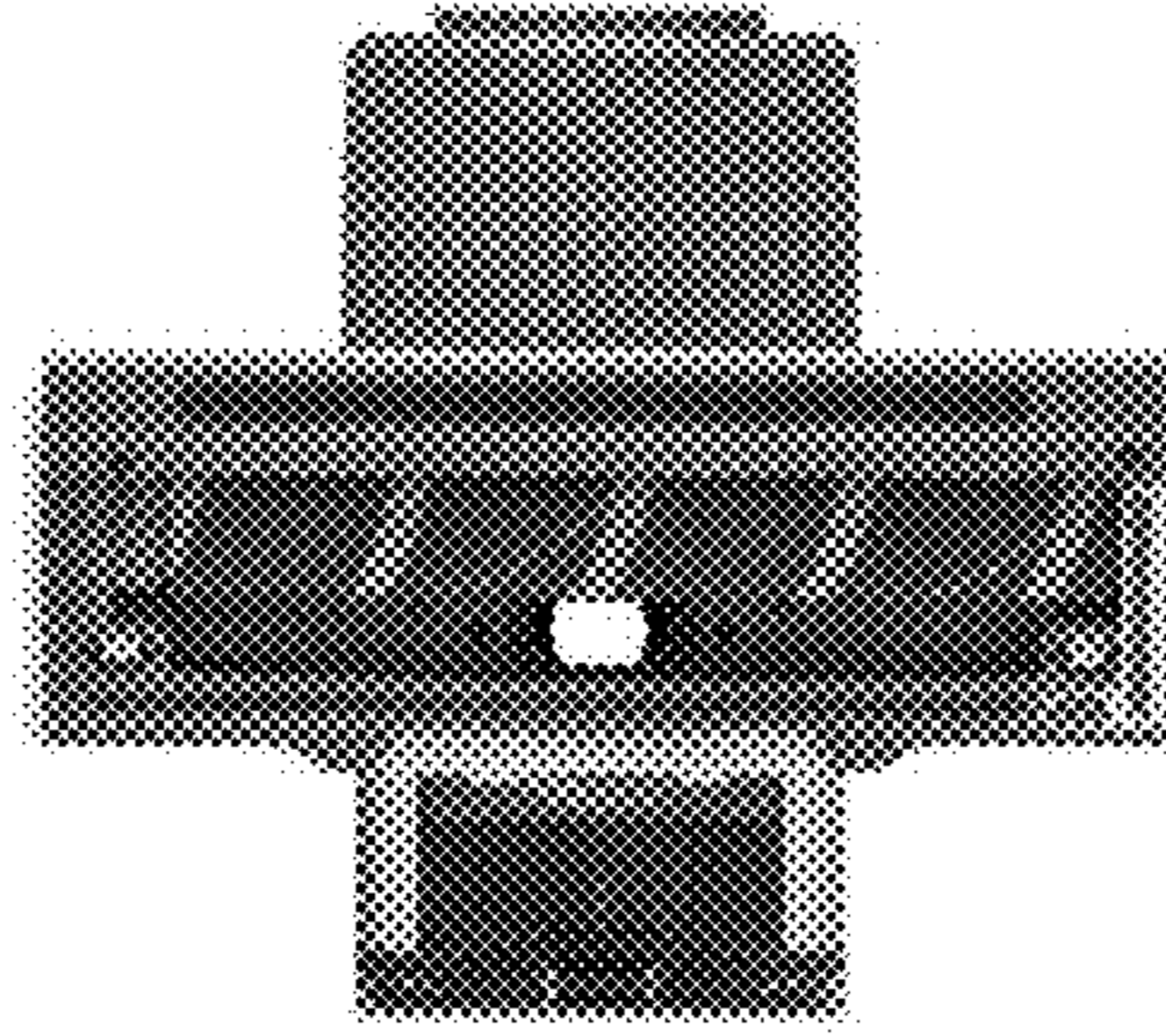

**1.6**

