



US00D982829S

(12) **United States Design Patent**
Youngjin

(10) **Patent No.:** **US D982,829 S**

(45) **Date of Patent:** **** Apr. 4, 2023**

- (54) **RAZOR CARTRIDGE**
- (71) Applicant: **Dorco Co., Ltd.**, Seoul (KR)
- (72) Inventor: **Lee Youngjin**, Seoul (KR)
- (73) Assignee: **DORCO CO., LTD.**, Seoul (KR)
- (**) Term: **15 Years**

D619,301 S *	7/2010	Wattam	D28/47
D754,399 S *	4/2016	Andersson	D28/54
D754,400 S *	4/2016	Andersson	D28/54
D756,565 S *	5/2016	Andersson	D28/54
D890,429 S *	7/2020	Chae	D28/47
D964,653 S *	9/2022	Washington	D28/47
2020/0316798 A1 *	10/2020	Walker, Jr.	B26B 21/42

- (21) Appl. No.: **29/776,296**
- (22) Filed: **Mar. 29, 2021**

FOREIGN PATENT DOCUMENTS

WO	WO-2021182830 A1 *	9/2021
WO	WO-2021182831 A1 *	9/2021

* cited by examiner

Primary Examiner — Jennifer Rivard

(30) **Foreign Application Priority Data**

Jan. 14, 2021 (KR) 30-2021-0002109

(51) **LOC (14) Cl.** **28-03**

(52) **U.S. Cl.**
USPC **D28/47; D28/54**

(58) **Field of Classification Search**
USPC D28/46-48, 54
CPC B26B 21/22-227; B26B 21/30; B26B
21/40-4006; B26B 21/4012-4031; B26B
21/56
See application file for complete search history.

(57) **CLAIM**

An ornamental design for a razor cartridge, as shown and described.

DESCRIPTION

FIG. 1 is a top, front and right side perspective of a razor cartridge showing my new design;
FIG. 2 is a front elevational view thereof;
FIG. 3 is a rear elevational view thereof;
FIG. 4 is a left side elevational view thereof;
FIG. 5 is a right side elevational view thereof;
FIG. 6 is top plan view thereof;
FIG. 7 is a bottom plan view thereof; and,
FIG. 8 is a bottom, front and left side perspective view thereof.

The broken lines illustrate portions of the razor cartridge and form no part of the claimed design.

(56) **References Cited**

U.S. PATENT DOCUMENTS

4,128,937 A *	12/1978	Adorney	B26B 21/52 30/47
D616,606 S *	5/2010	Adams	D28/47
D617,497 S *	6/2010	Goodhead	D28/47

1 Claim, 8 Drawing Sheets

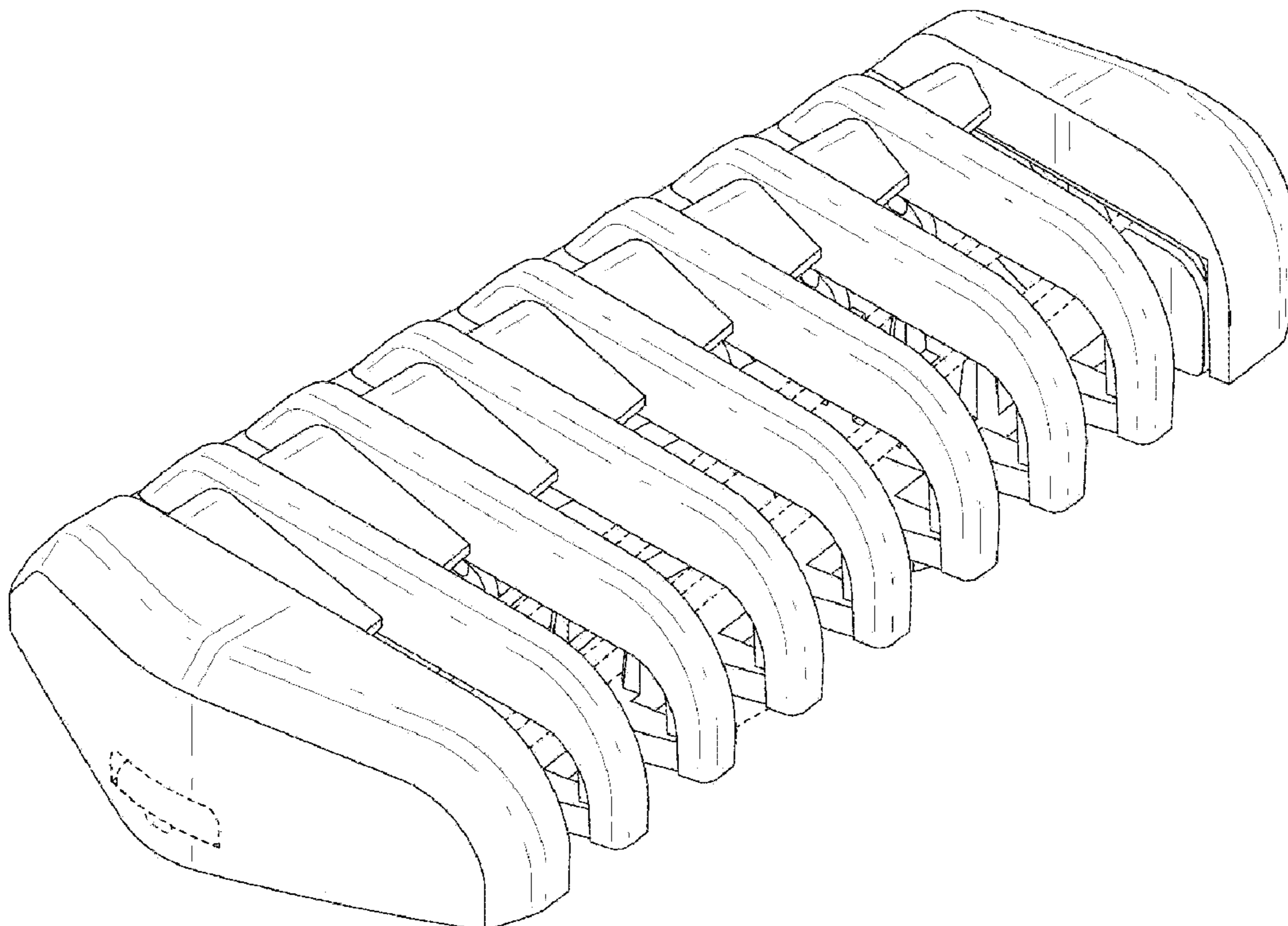

FIG. 1

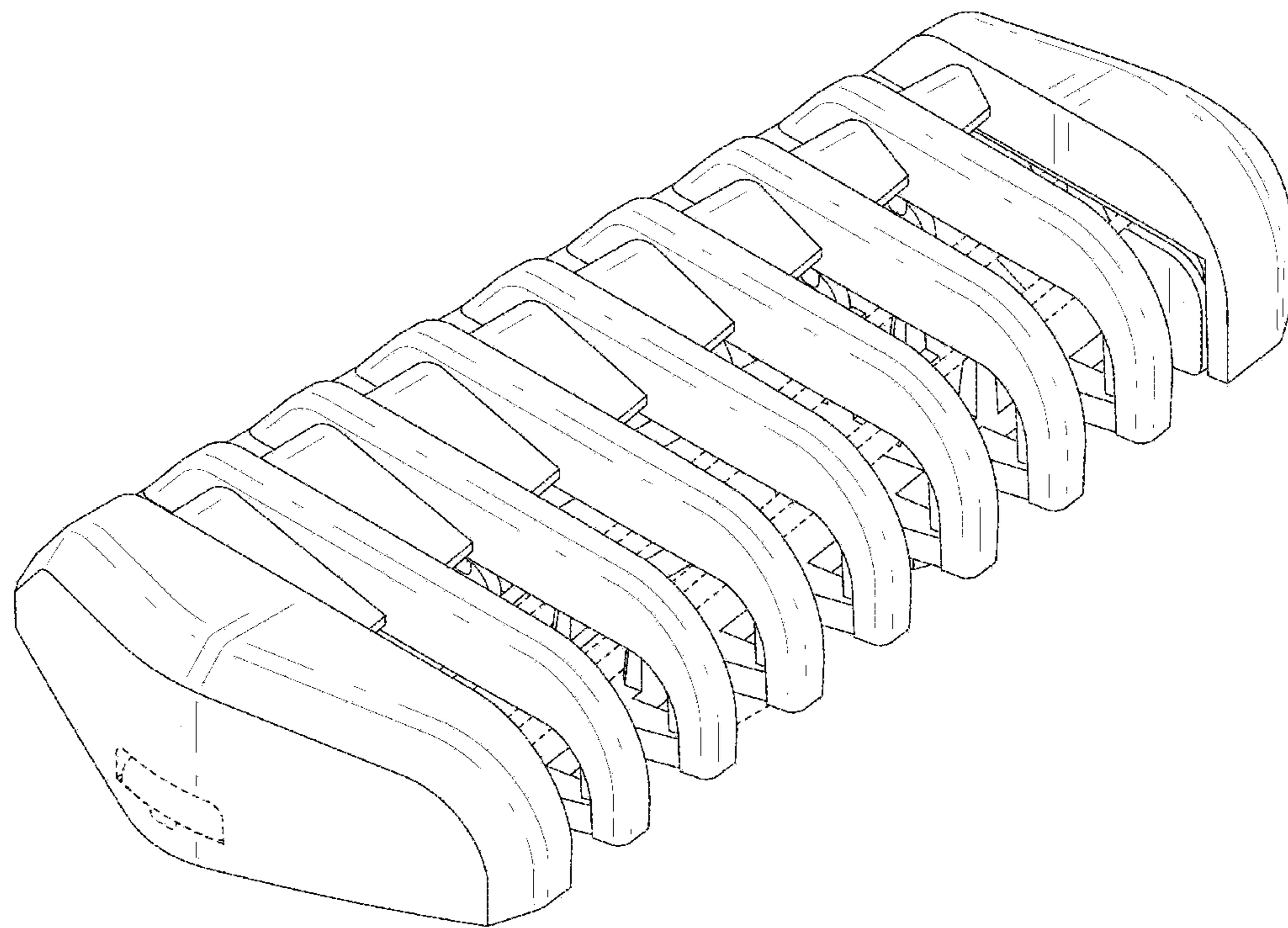

FIG. 2

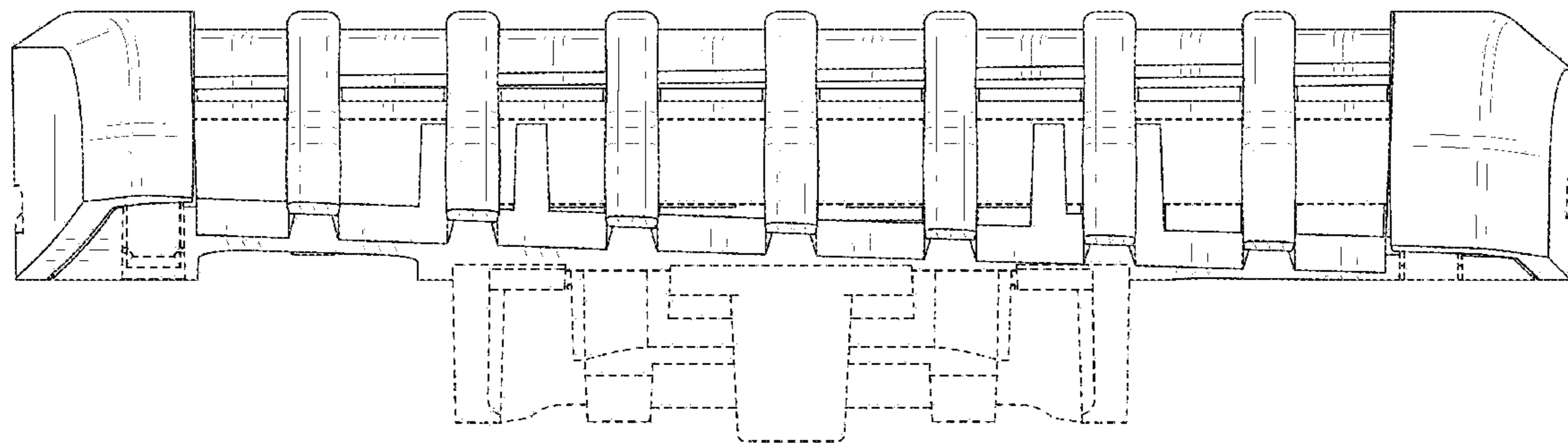

FIG. 3

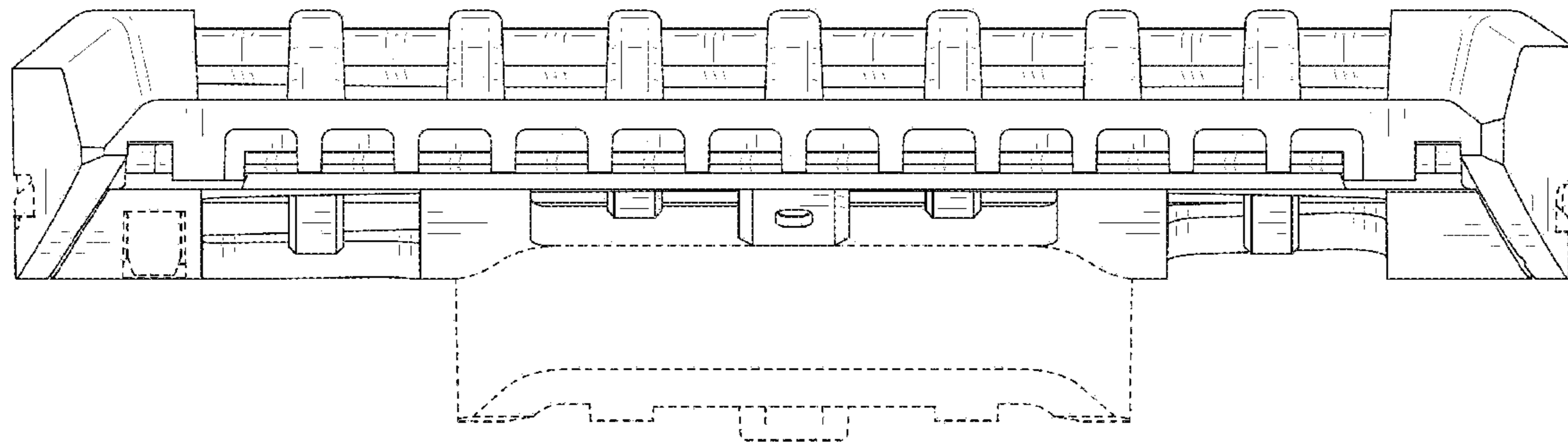

FIG. 4

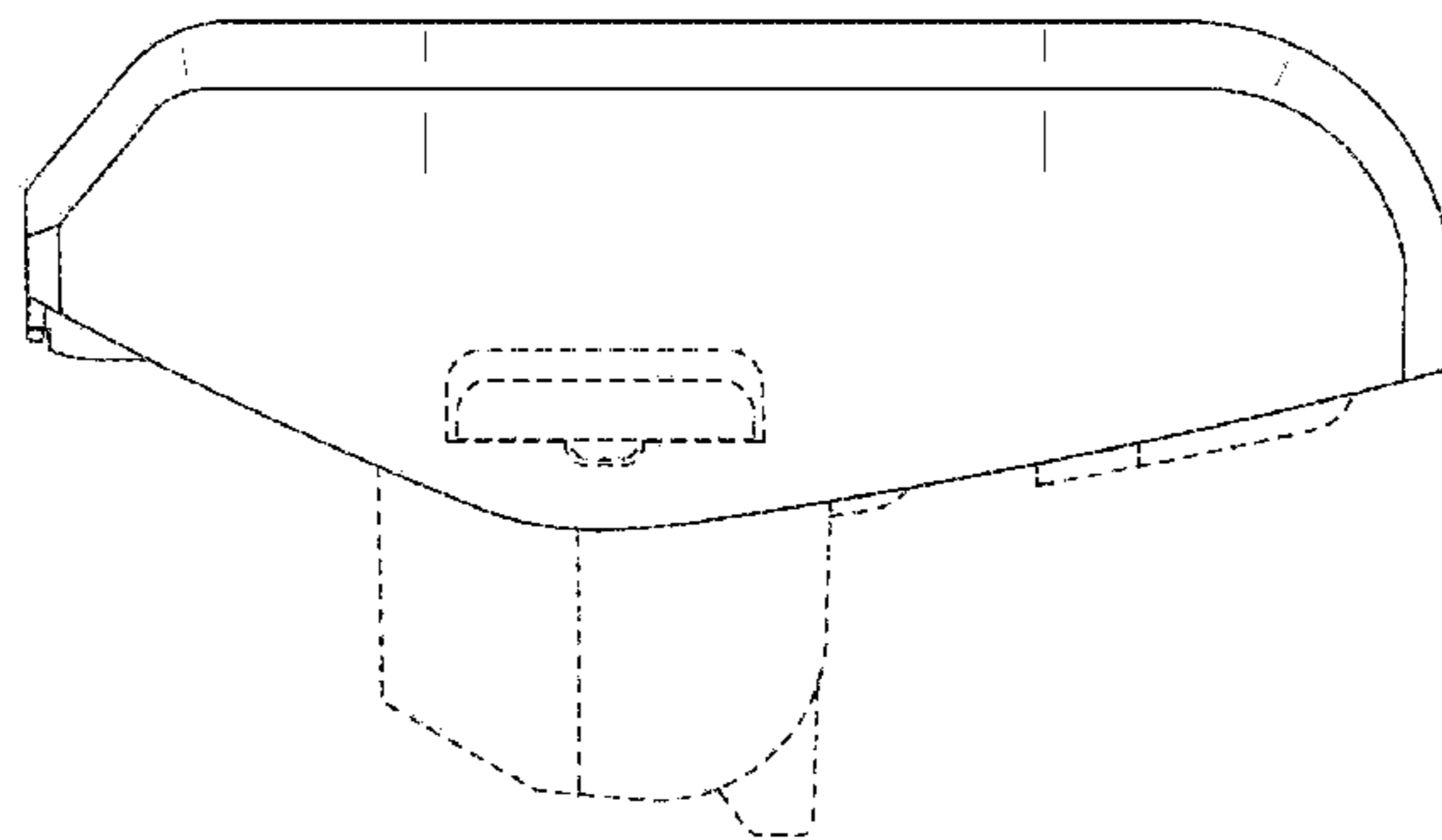

FIG. 5

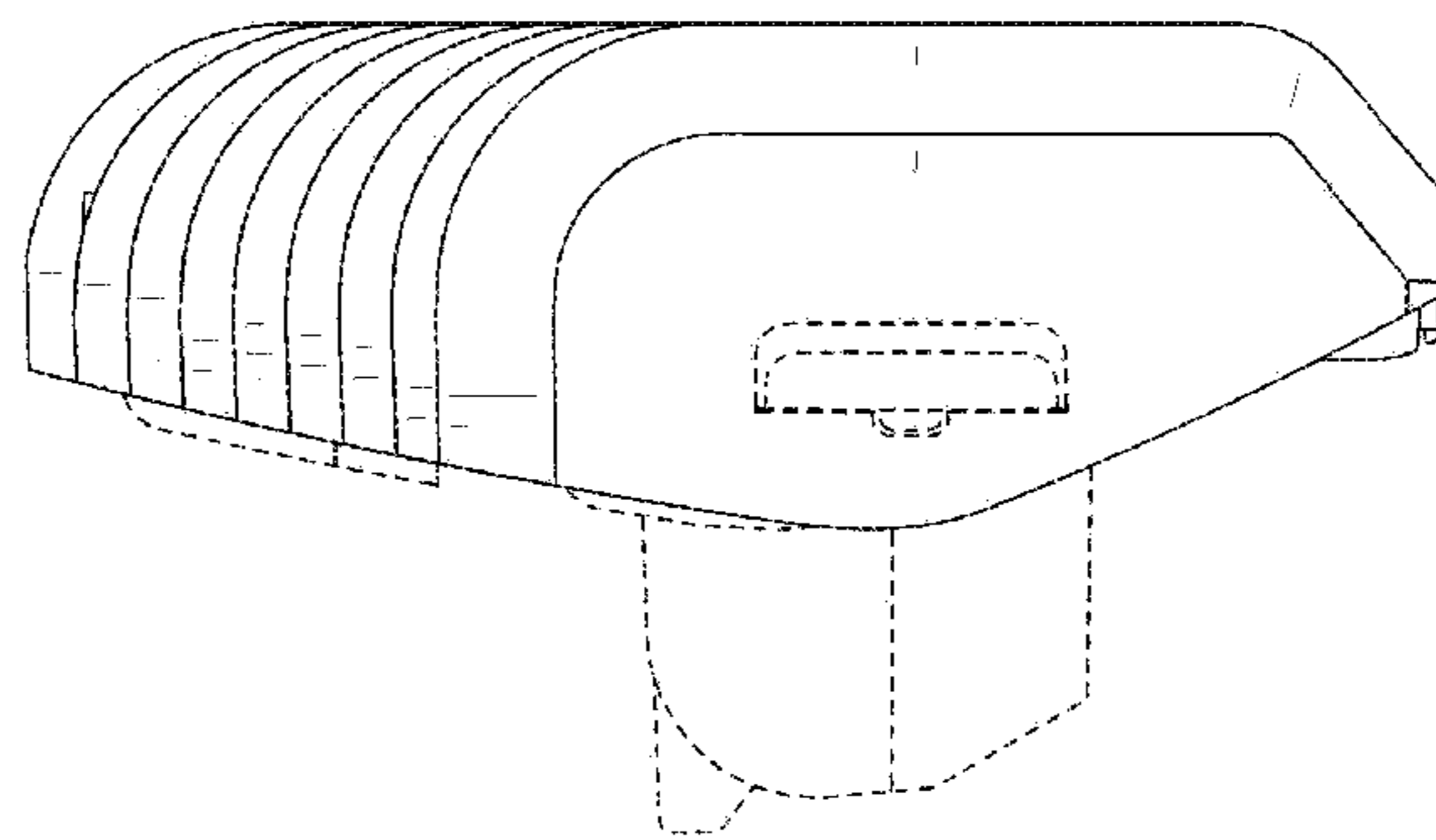

FIG. 6

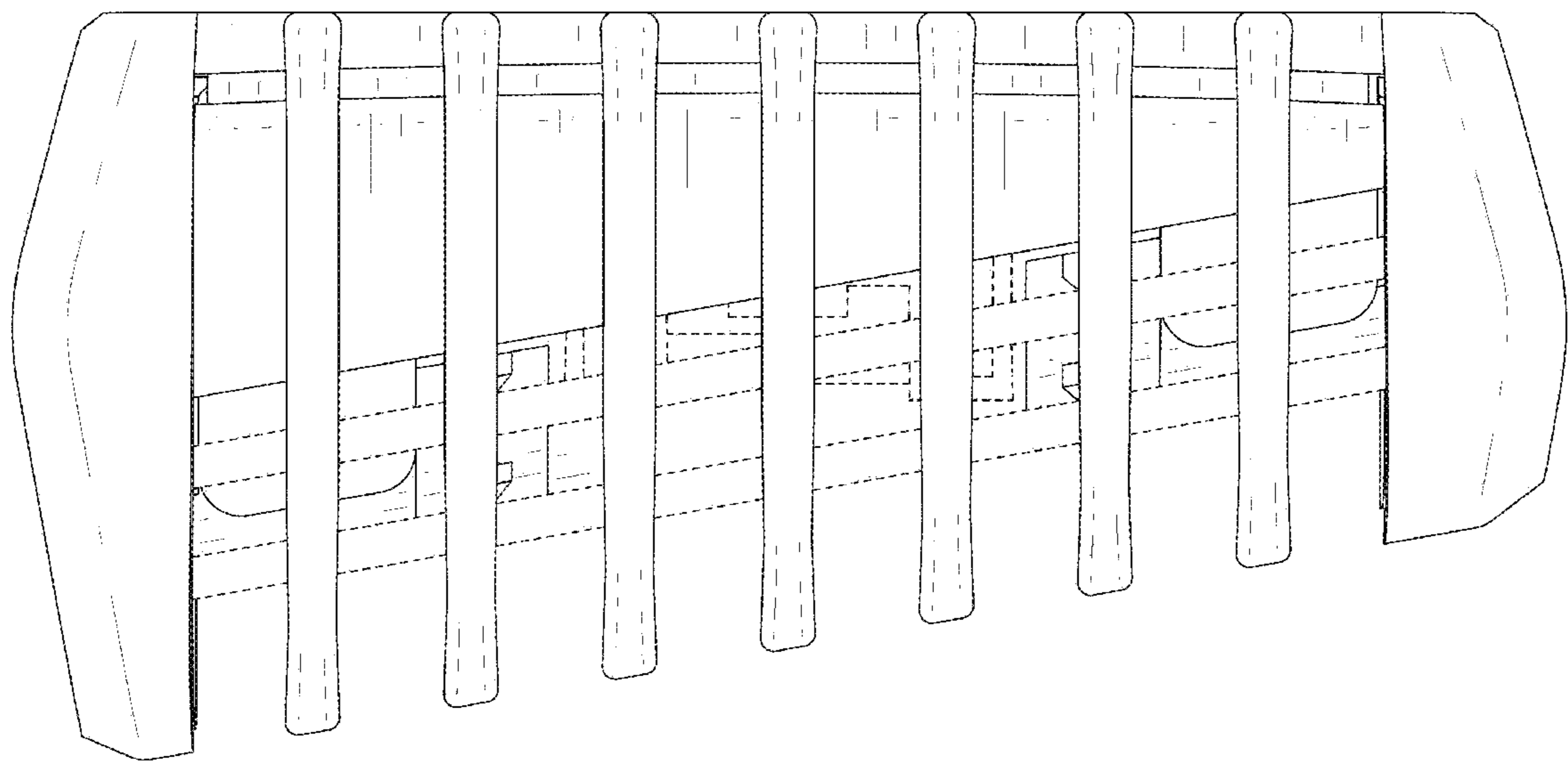

FIG. 7

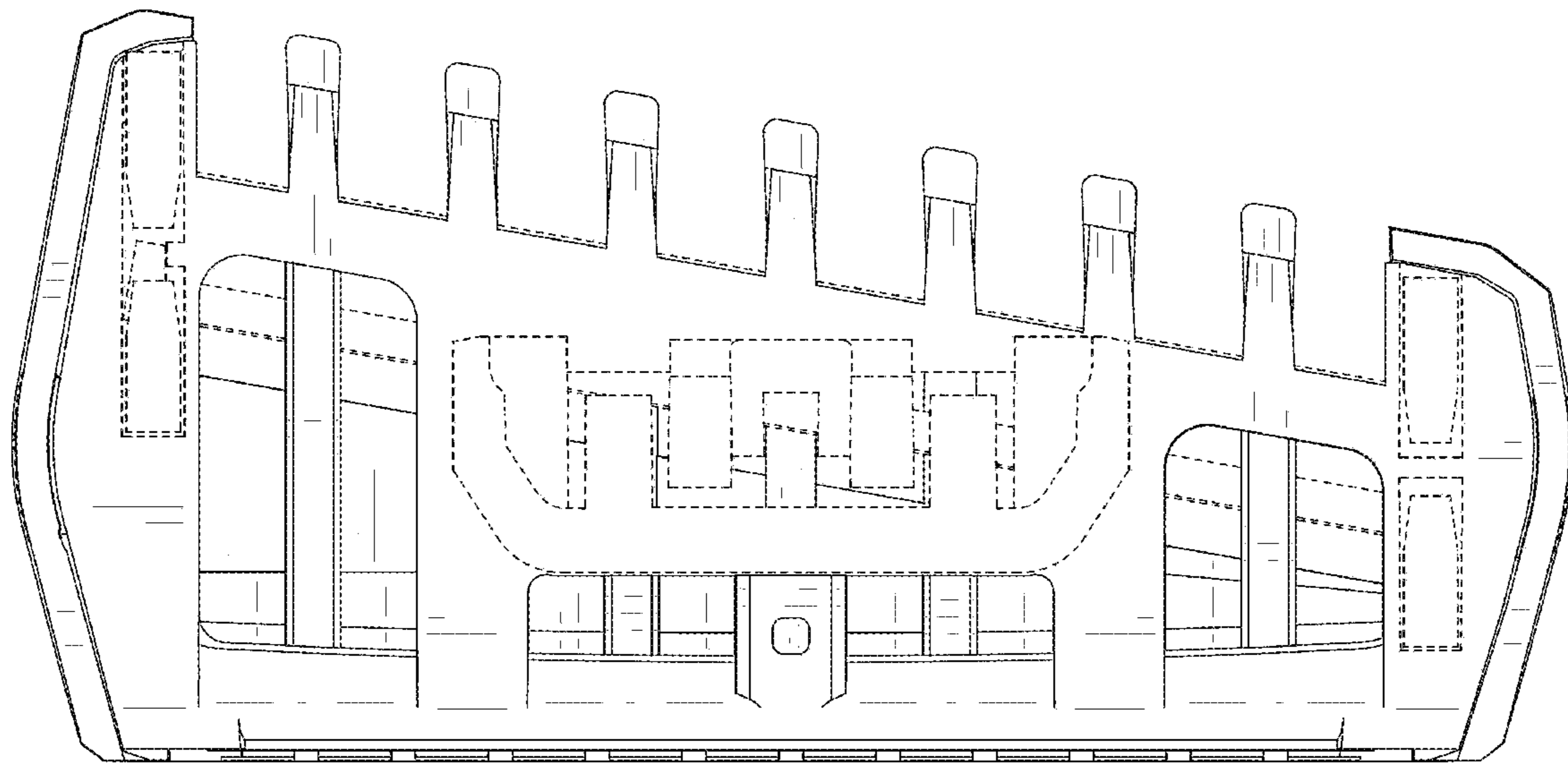

FIG. 8

