



US00D982774S

(12) **United States Design Patent**
Peng

(10) **Patent No.:** **US D982,774 S**

(45) **Date of Patent:** **** Apr. 4, 2023**

(54) **MASSAGER**

(71) Applicant: **Shenzhen Breo Technology Co., Ltd.**,
Shenzhen (CN)

(72) Inventor: **Shangke Peng**, Guangdong (CN)

(73) Assignee: **SHENZHEN BREO TECHNOLOGY CO., LTD.**, Shenzhen (CN)

(**) Term: **15 Years**

(21) Appl. No.: **35/512,497**

(22) Filed: **Aug. 10, 2021**

(80) **Hague Agreement Data**

Int. Filing Date: **Aug. 10, 2021**

Int. Reg. No.: **DM/216051**

Int. Reg. Date: **Aug. 10, 2021**

Int. Reg. Pub. Date: **Sep. 3, 2021**

(30) **Foreign Application Priority Data**

Mar. 24, 2021 (CN) 202130161578.6

(51) **LOC (14) Cl.** **24-01**

(52) **U.S. Cl.**
USPC **D24/215**

(58) **Field of Classification Search**

USPC D24/191, 200, 211, 212, 213, 214, 215;
D16/310, 312, 320, 324; D29/105, 106,
D29/108, 110

CPC A61H 2205/04; A61H 7/007; A61H
2201/1609; A61H 2205/062; A61H
2201/0207

See application file for complete search history.

(56) **References Cited**

U.S. PATENT DOCUMENTS

D250,835 S * 1/1979 Grube D24/215
D739,543 S * 9/2015 Ma D24/215

D769,453 S * 10/2016 Ma D24/215
D884,913 S * 5/2020 Peng D24/215
D888,263 S * 6/2020 Du D24/215
D928,335 S * 8/2021 Ma D24/215
2017/0252258 A1* 9/2017 Ma A61H 5/00

OTHER PUBLICATIONS

Amazon, "Eye Massager with Heat", Date First Available: Aug. 19, 2022. https://www.amazon.com/Massager-Vibration-Bluetooth-Circulation-SKG/dp/B0BB68GH8V/ref=cm_cr_arp_d_product_top?ie=UTF8 (Year: 2022).*

(Continued)

Primary Examiner — Michael A Maharajh

(74) *Attorney, Agent, or Firm* — Andrew C. Cheng

(57) **CLAIM**

The ornamental design for a massager, as shown and described.

DESCRIPTION

- 1. Massager
- 2. Massager
- 1.1 : Front
- 1.2 : Back
- 1.3 : Left
- 1.4 : Right
- 1.5 : Top
- 1.6 : Bottom
- 1.7 : Perspective
- 2.1 : Front
- 2.2 : Back
- 2.3 : Left
- 2.4 : Right
- 2.5 : Top
- 2.6 : Bottom
- 2.7 : Perspective

Figs. 1.1-1.7 are drawings showing a first embodiment of the massager; figs. 2.1-2.7 are drawings showing a second embodiment of the massager.

1 Claim, 14 Drawing Sheets

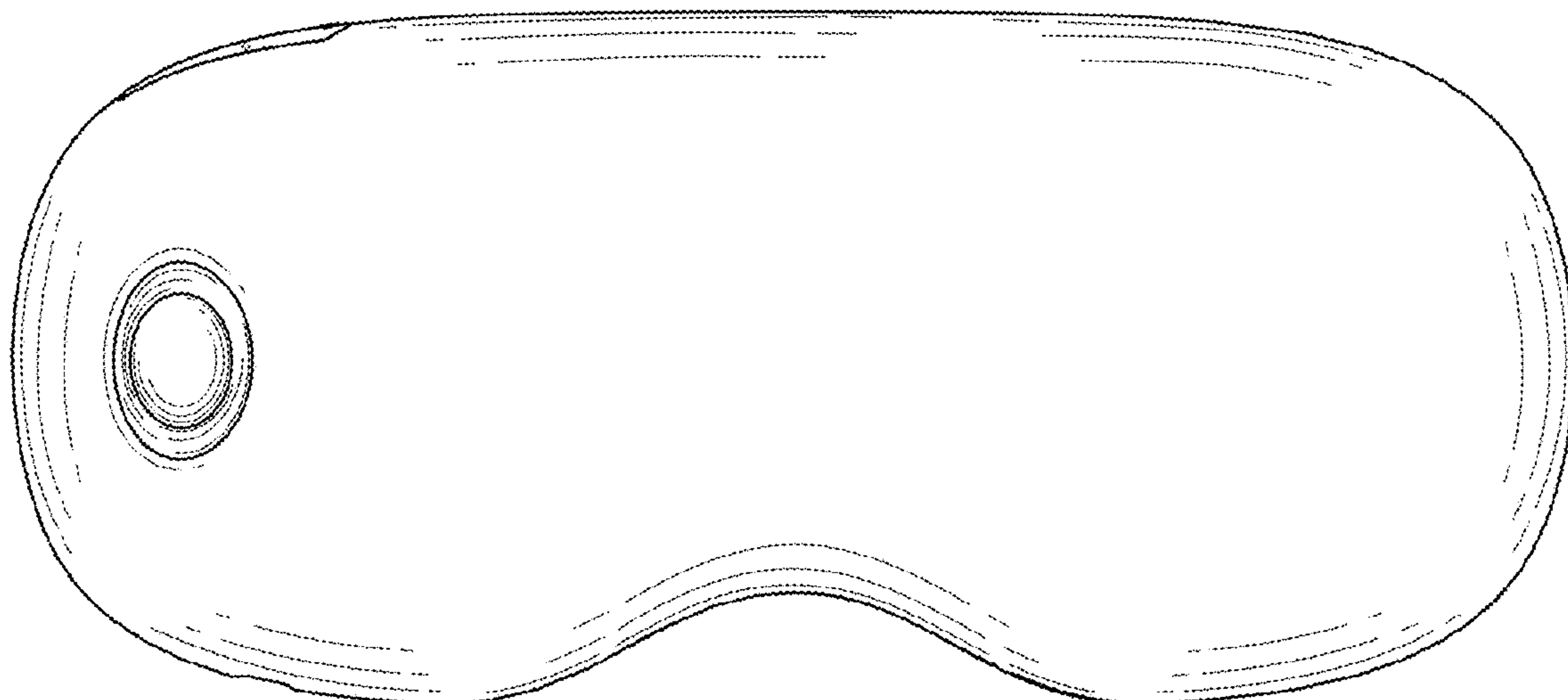

(56)

References Cited

OTHER PUBLICATIONS

Amazon, "Heated Eye Massager", Date First Available: Aug. 11, 2022. https://www.amazon.com/Homesnew-Massager-Foldable-Vibration-Migraine/dp/B0B9GQRH3X/ref=cm_cr_ar_p_d_product_top?ie=UTF8 (Year: 2022).*

Amazon, "Fitssage 3D Vibration Eye Massager", Date First Available: Jun. 24, 2021. https://www.amazon.com/FITSSAGE-Vibration-Massager-Reduce-Strain/dp/B097TD8X2M/ref=cm_cr_ar_p_d_product_top?ie=UTF8 (Year: 2021).*

Amazon, "Comfier Eye Massager", Date First Available: Jan. 20, 2022. https://www.amazon.com/Comfier-Massager-Bluetooth-Kneading-Migraines/dp/B09QSQQ82P/ref=cm_cr_ar_p_d_product_top?ie=UTF8 (Year: 2022).*

* cited by examiner

1.1

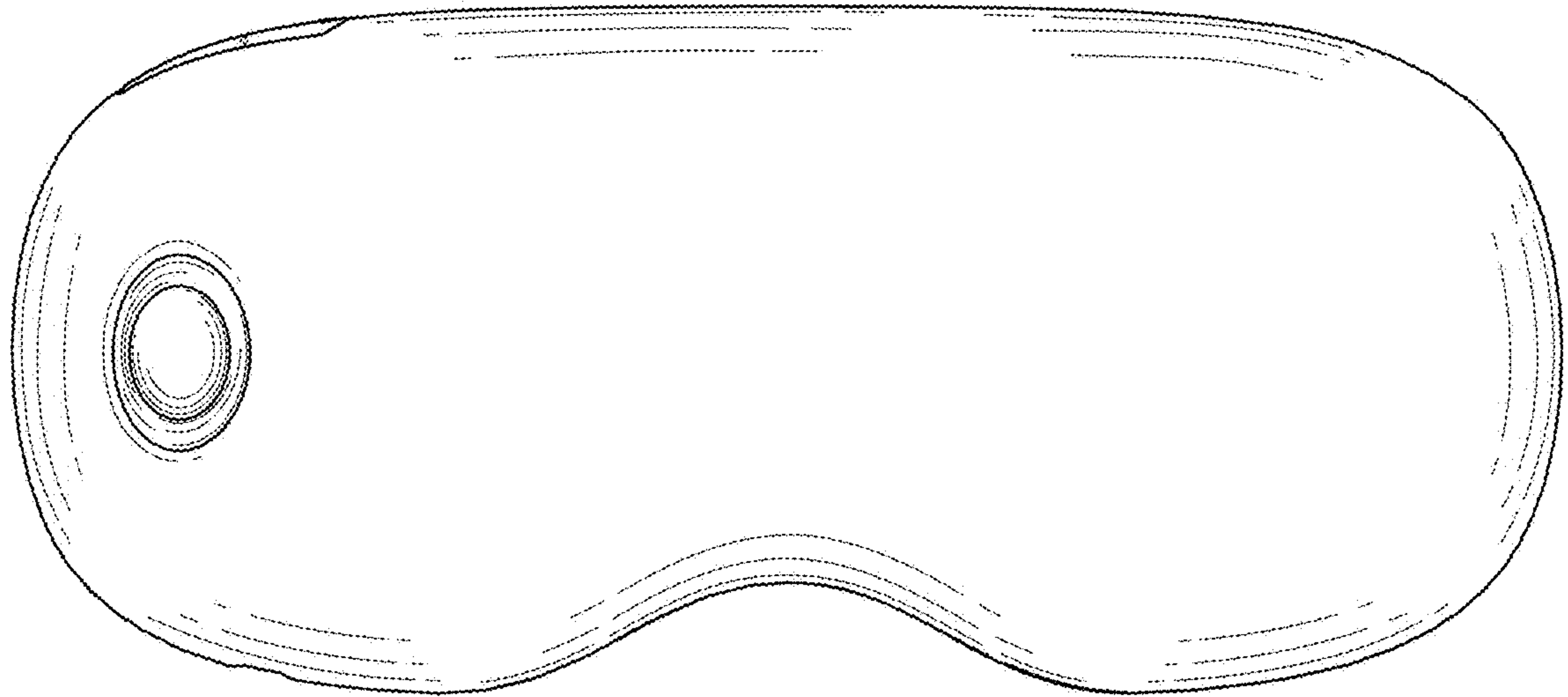

1.2

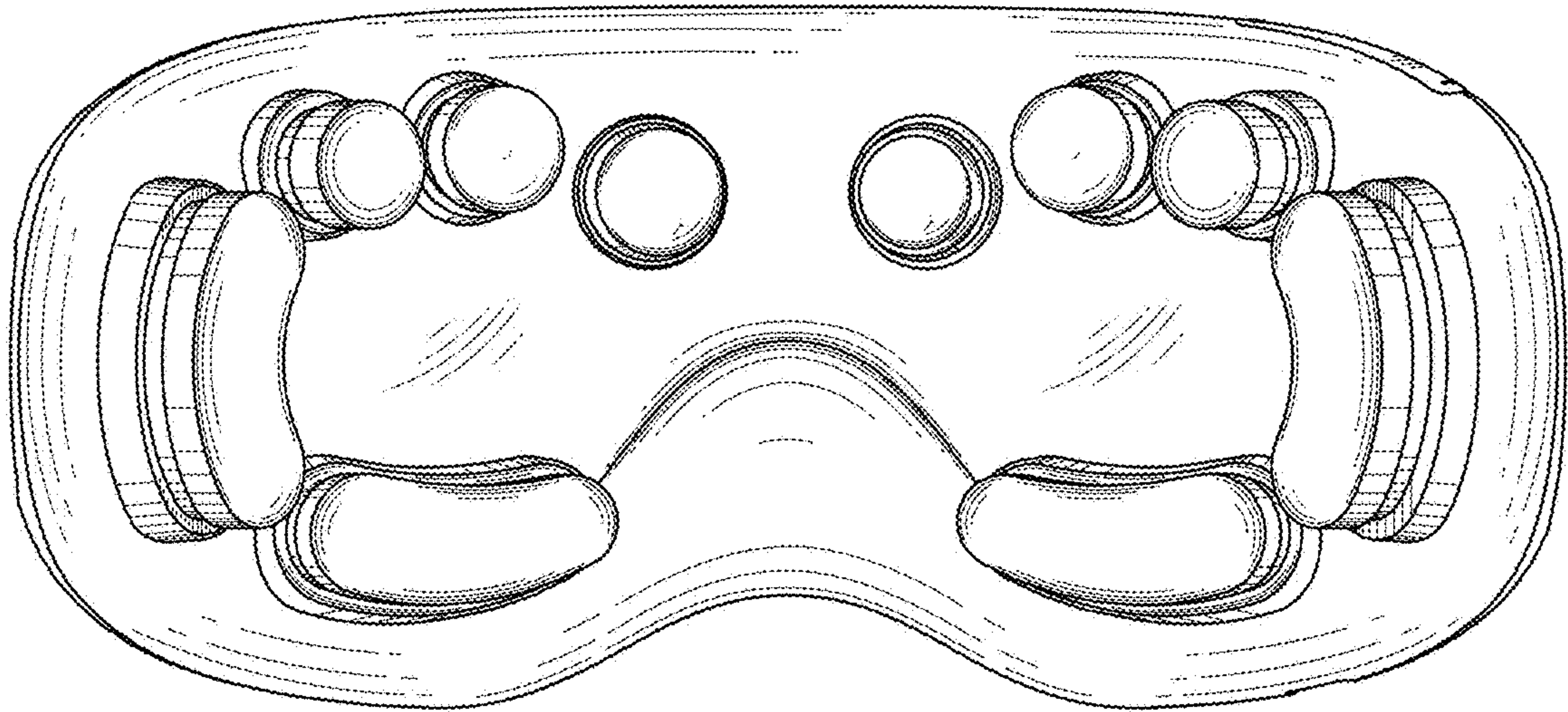

1.3

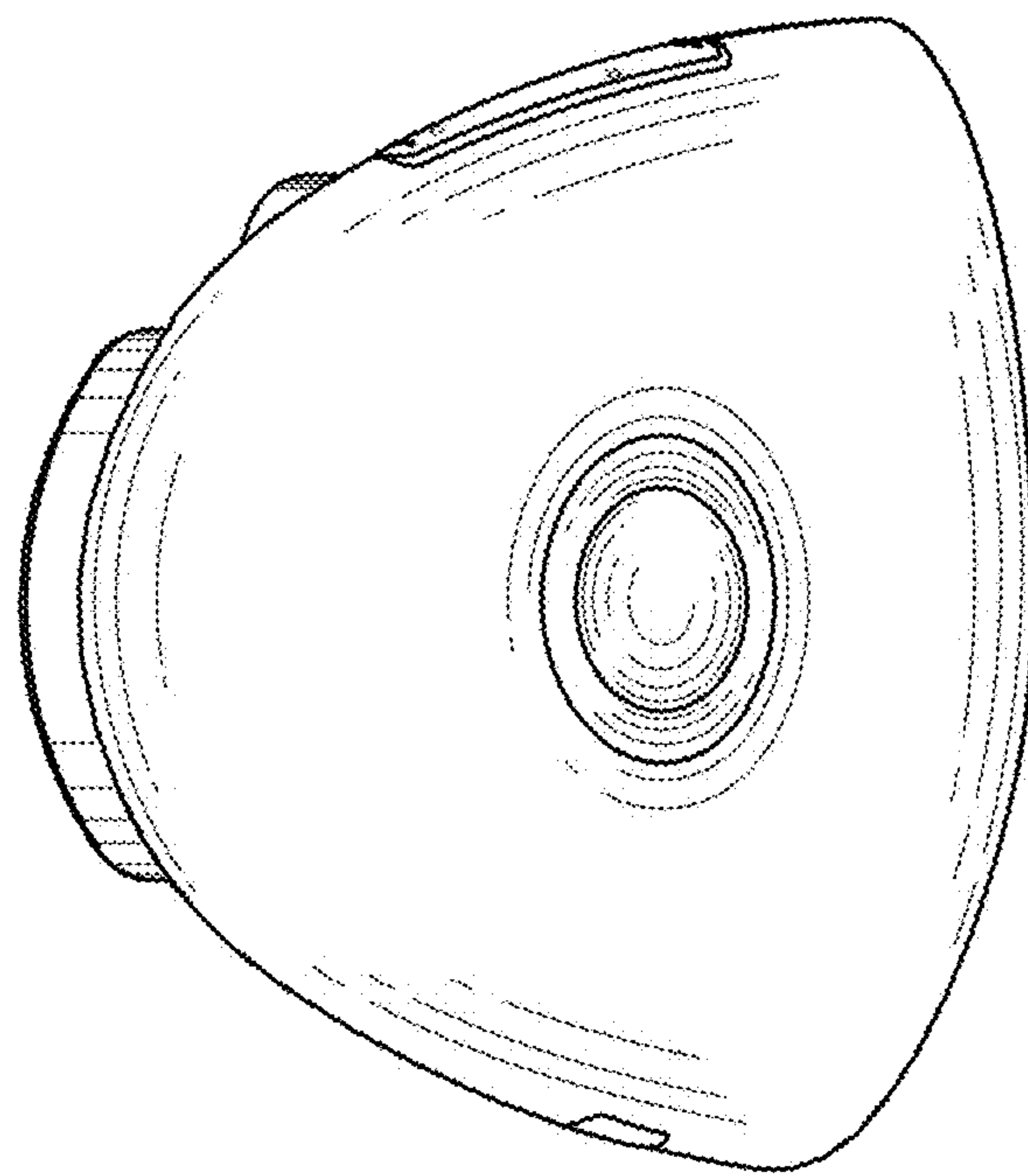

1.4

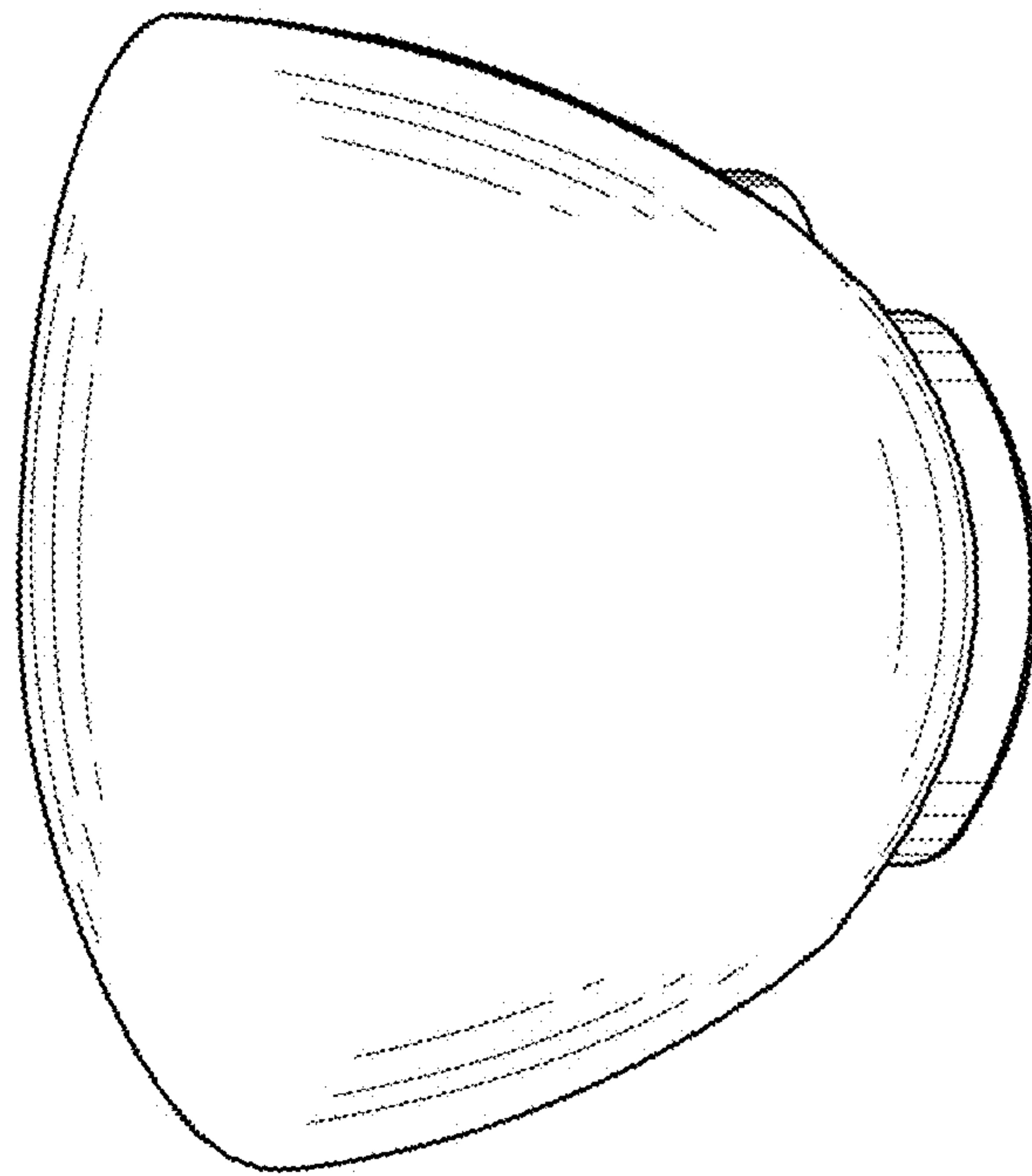

1.5

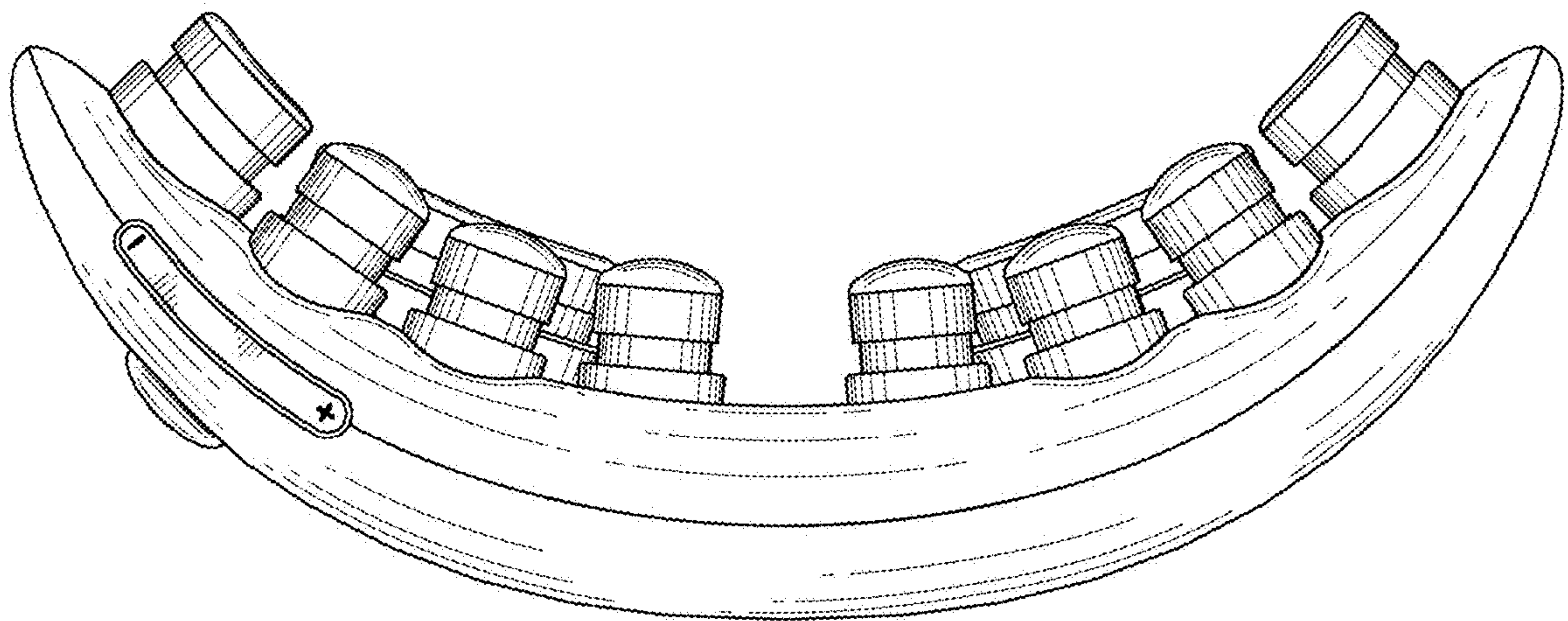

1.6

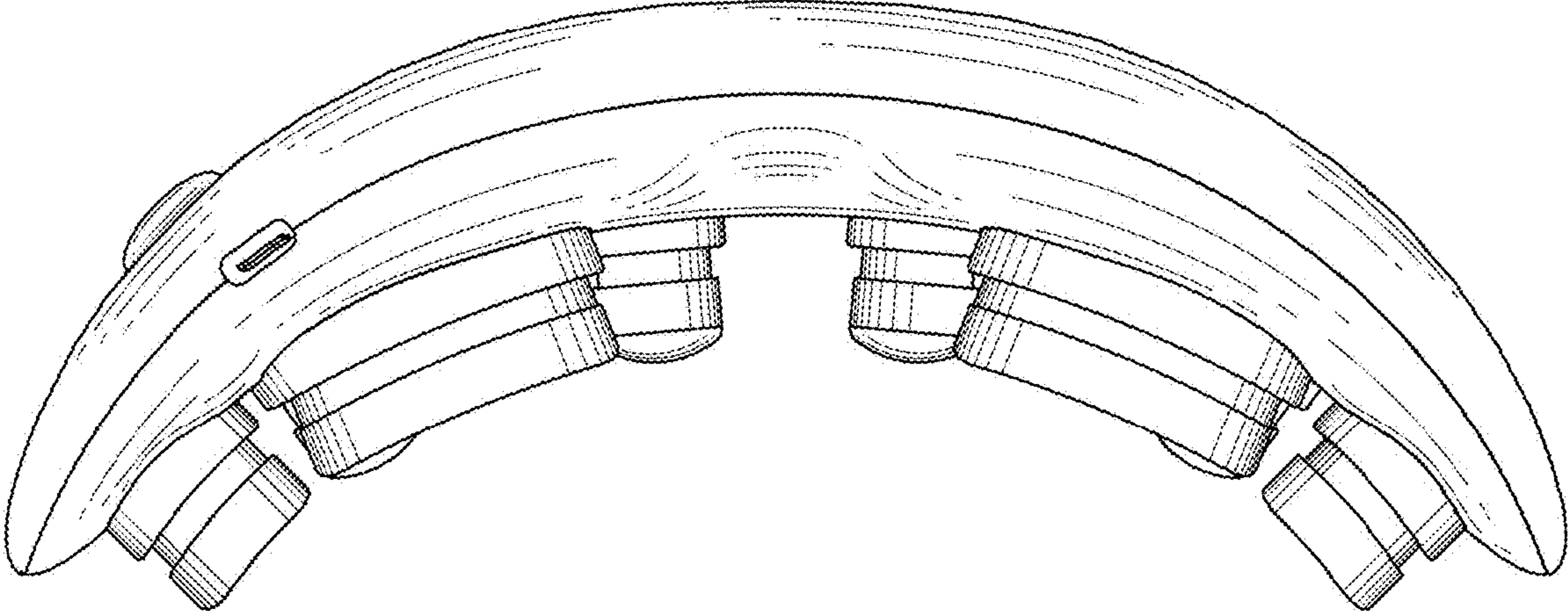

1.7

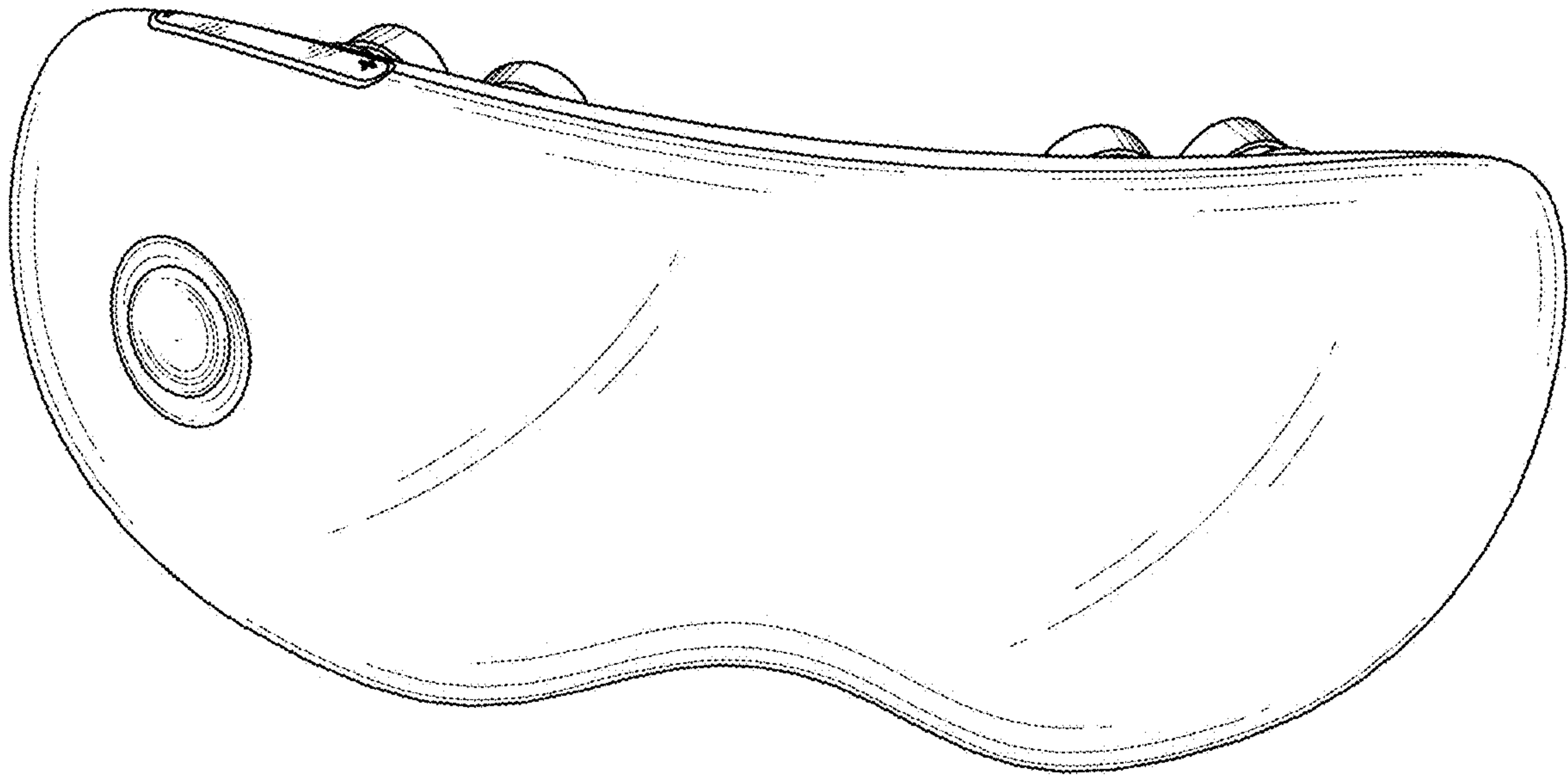

2.1

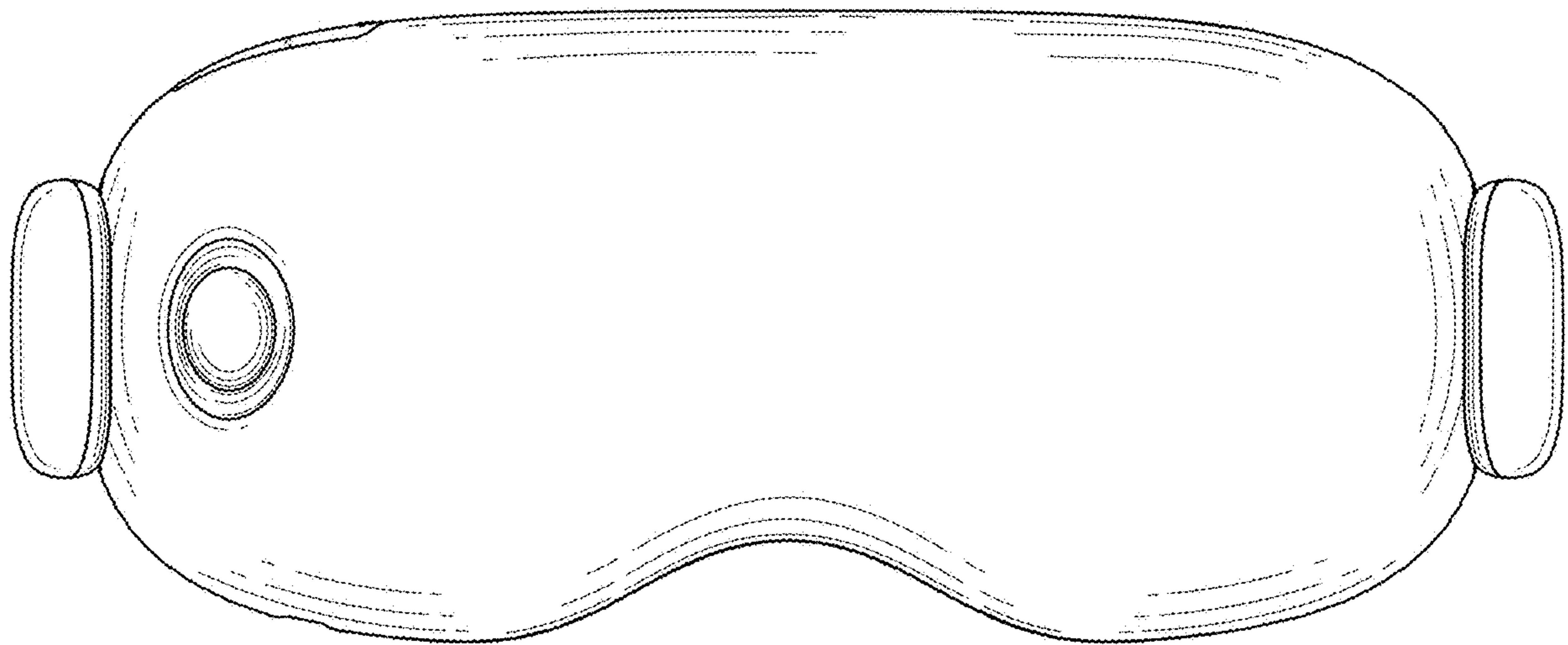

2.2

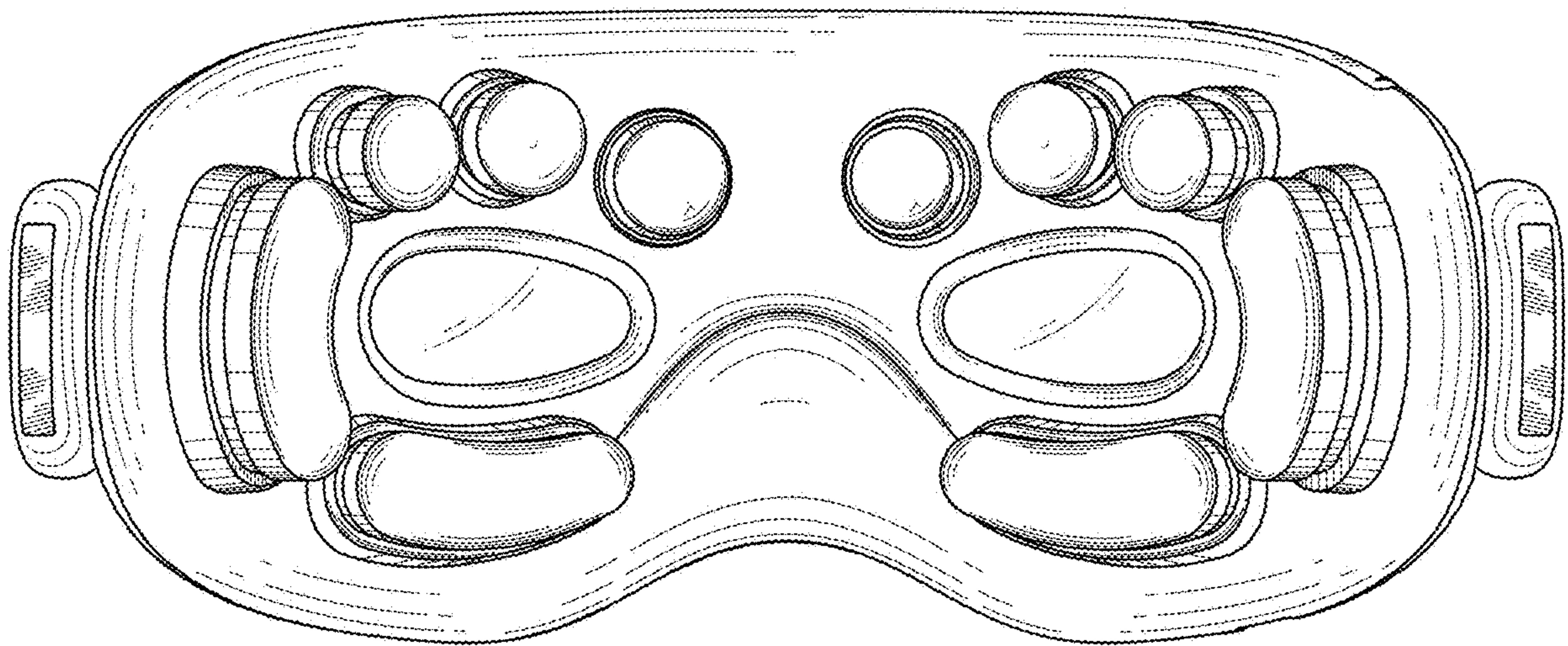

2.3

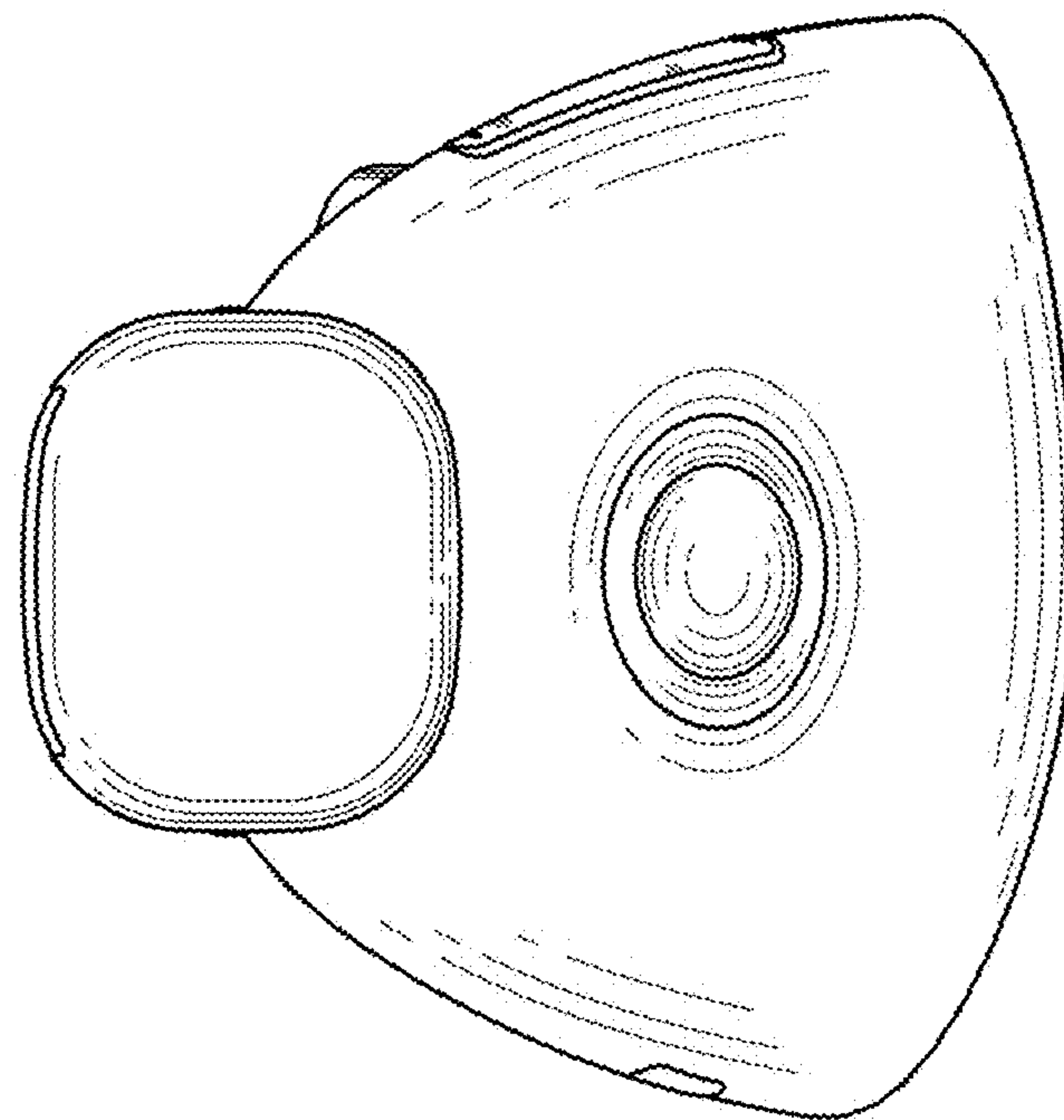

2.4

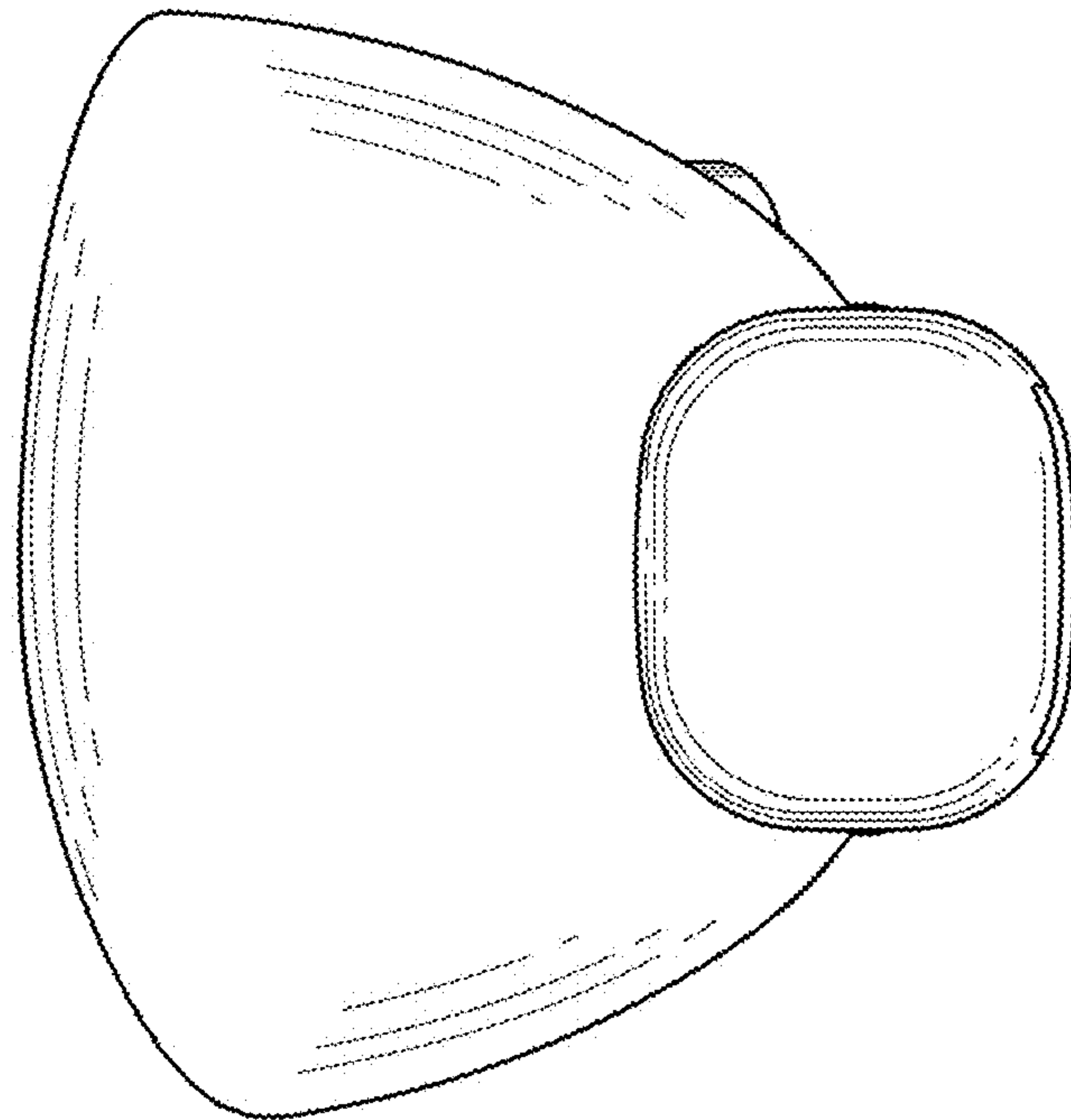

2.5

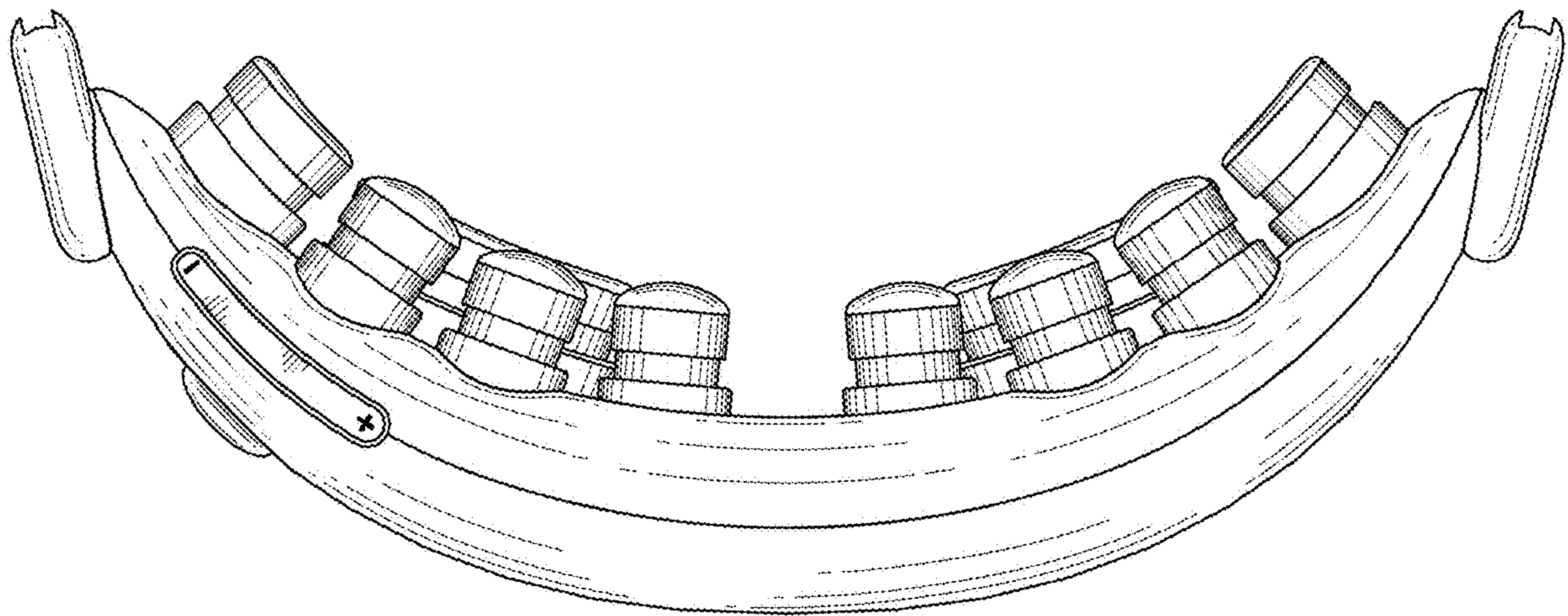

2.6

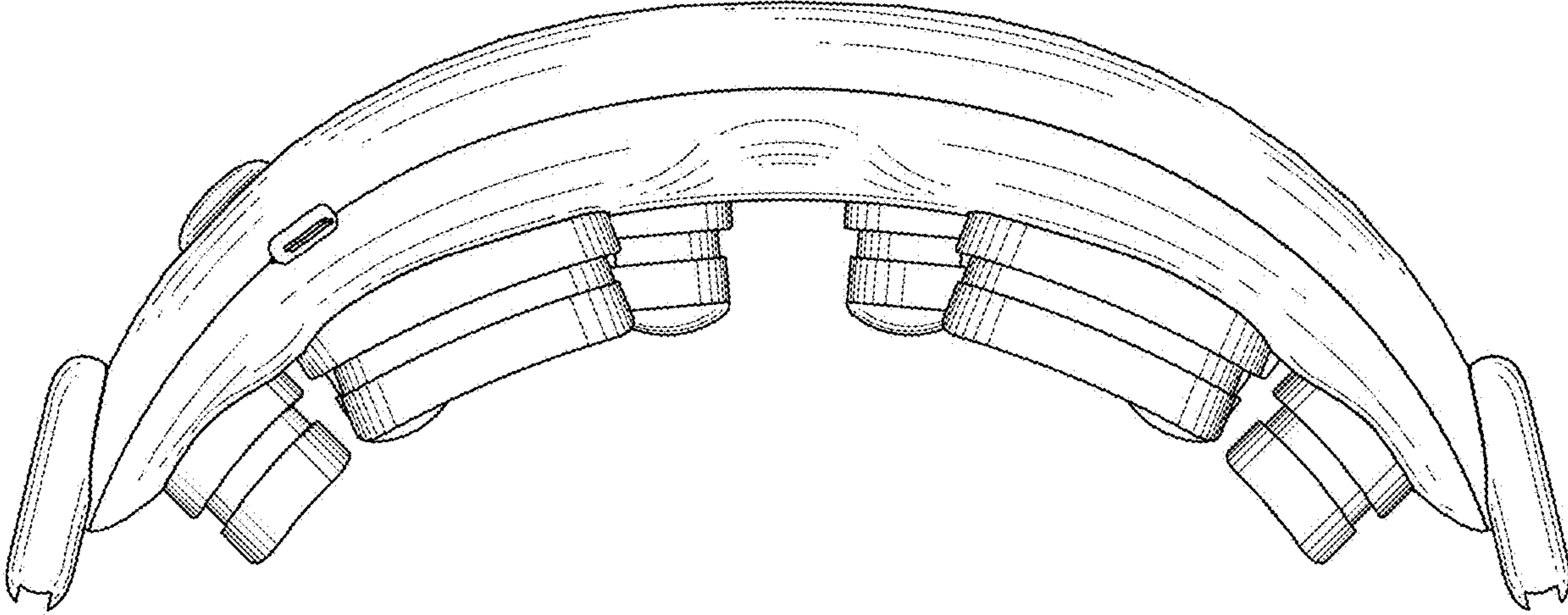

2.7

