



US00D982729S

(12) **United States Design Patent** (10) **Patent No.:** **US D982,729 S**  
**Jiang** (45) **Date of Patent:** **\*\* Apr. 4, 2023**

(54) **BIDET APPARATUS**

(71) Applicant: **Xiamen Soothingware Sanitary Co., Ltd.**, Xiamen (CN)

(72) Inventor: **Jianbing Jiang**, Xiamen (CN)

(73) Assignee: **XIAMEN SOOTHINGWARE SANITARY CO., LTD.**, Xiamen (CN)

(\*\*) Term: **15 Years**

(21) Appl. No.: **29/812,596**

(22) Filed: **Oct. 22, 2021**

(30) **Foreign Application Priority Data**

Sep. 13, 2021 (CN) ..... 202130605737.7

(51) **LOC (14) Cl.** ..... **23-02**

(52) **U.S. Cl.**  
USPC ..... **D23/309**

(58) **Field of Classification Search**  
USPC ..... D23/303, 308-309, 311-312  
See application file for complete search history.

(56) **References Cited**

**U.S. PATENT DOCUMENTS**

10,844,586 B2 \* 11/2020 Gupta ..... E03D 9/08  
D937,396 S \* 11/2021 Yan ..... D23/309  
11,505,934 B2 \* 11/2022 Gupta ..... A47K 4/00

\* cited by examiner

*Primary Examiner* — Robert A Delehanty

(74) *Attorney, Agent, or Firm* — Cooper Legal Group, LLC

(57) **CLAIM**

The ornamental design for a bidet apparatus, as shown and described.

**DESCRIPTION**

FIG. 1 is a front elevational view of a first embodiment of the bidet apparatus showing the new design; FIG. 2 is a rear elevational view thereof; FIG. 3 is a left-side elevational view thereof; FIG. 4 is a right-side elevational view thereof; FIG. 5 is a top plan view thereof; FIG. 6 is a bottom plan view thereof; FIG. 7 is a first perspective view thereof; FIG. 8 is a second perspective view thereof; FIG. 9 is an enlarged view of the encircled portion '9' in FIG. 8 thereof; FIG. 10 is an enlarged view of the encircled portion '10' in FIG. 8 thereof; FIG. 11 is a front elevational view of a second embodiment of the bidet apparatus showing the new design; FIG. 12 is a rear elevational view thereof; FIG. 13 is a left-side elevational view thereof; FIG. 14 is a right-side elevational view thereof; FIG. 15 is a top plan view thereof; FIG. 16 is a bottom plan view thereof; FIG. 17 is a first perspective view thereof; FIG. 18 is a second perspective view thereof; FIG. 19 is an enlarged view of the encircled portion '19' in FIG. 18 thereof; and, FIG. 20 is an enlarged view of the encircled portion '20' in FIG. 18.

The broken lines shown in the drawings are for the purpose of illustrating portions of the article and form no part of the claimed design.

**1 Claim, 20 Drawing Sheets**

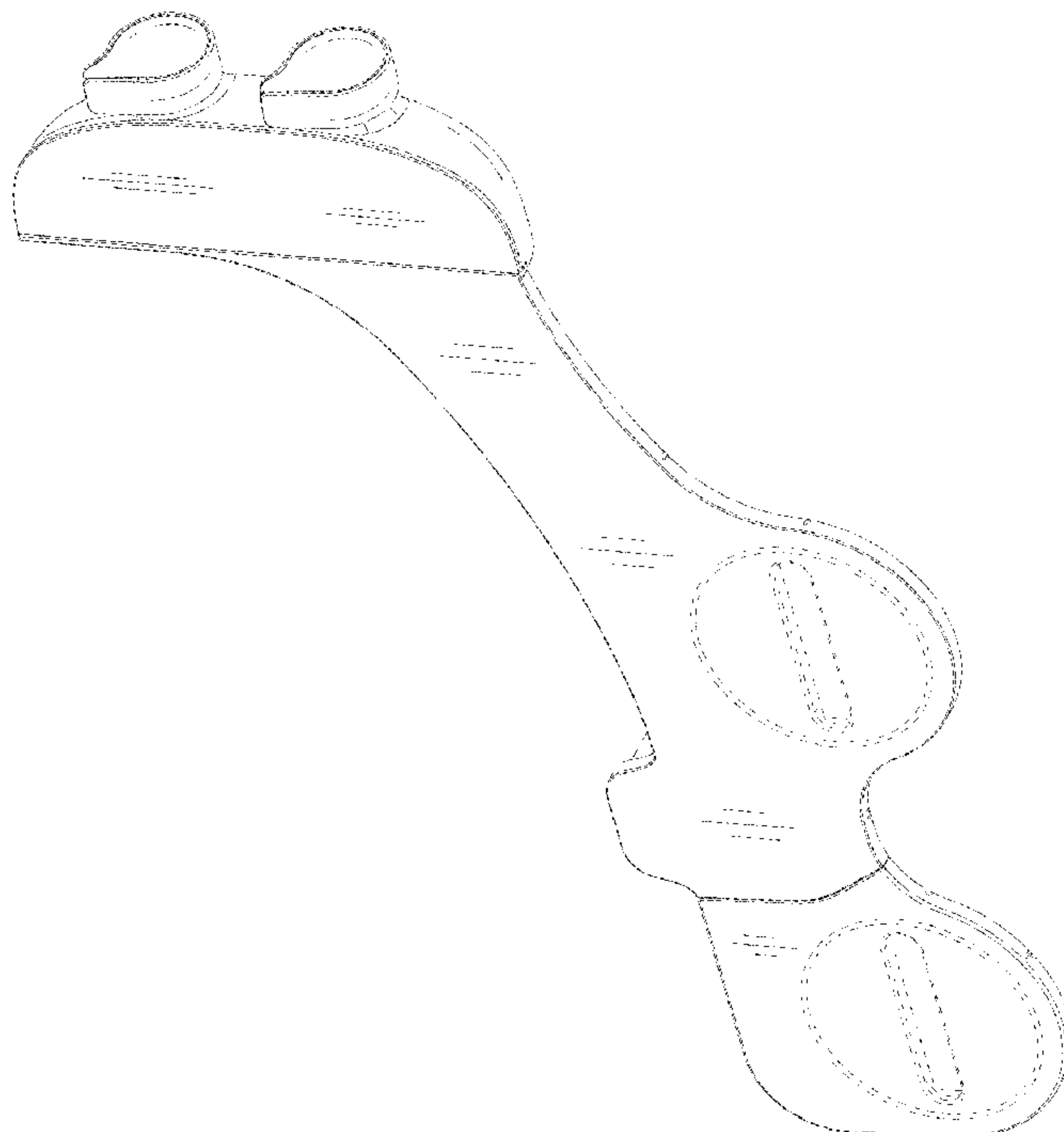

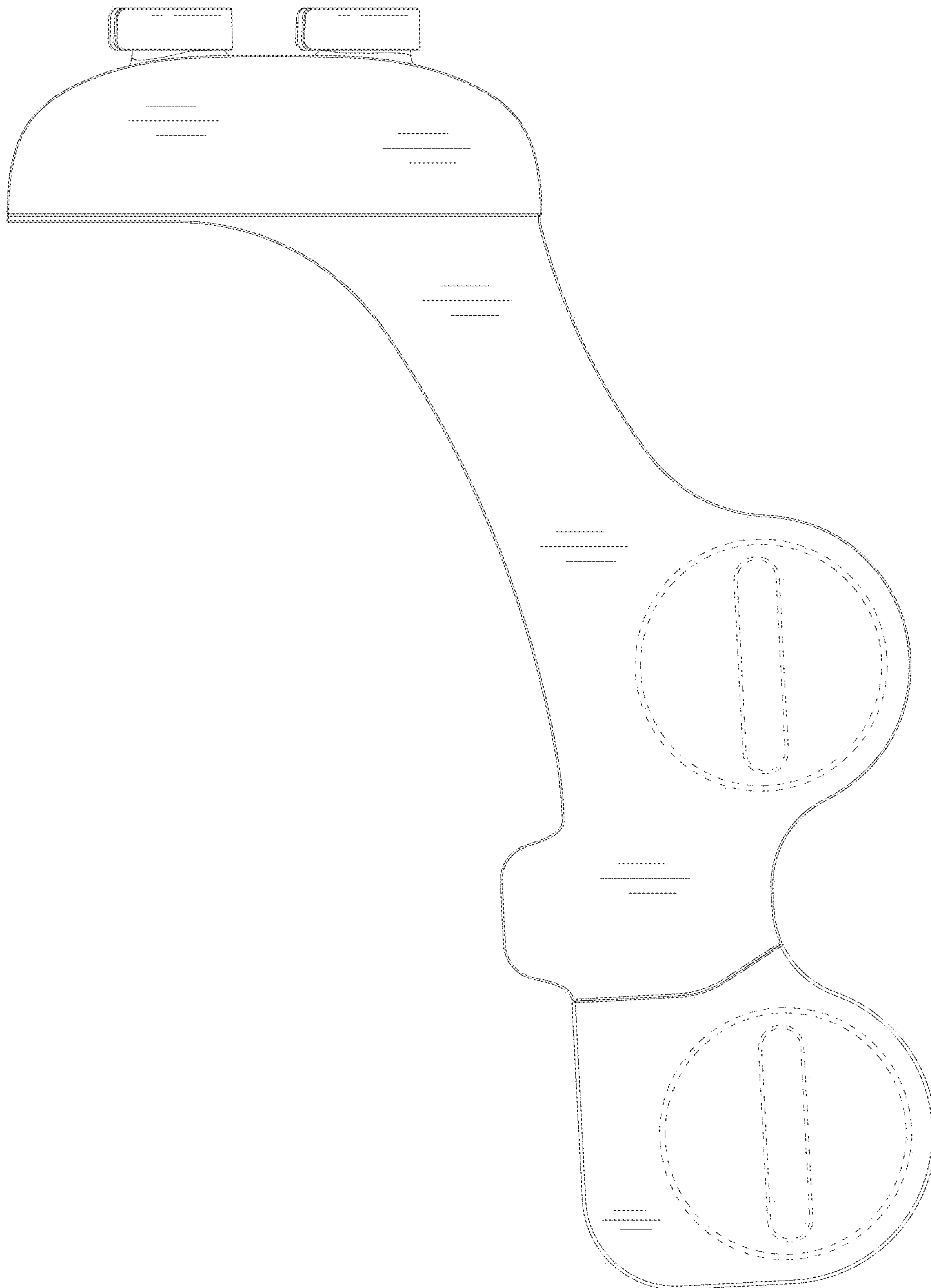

FIG. 1

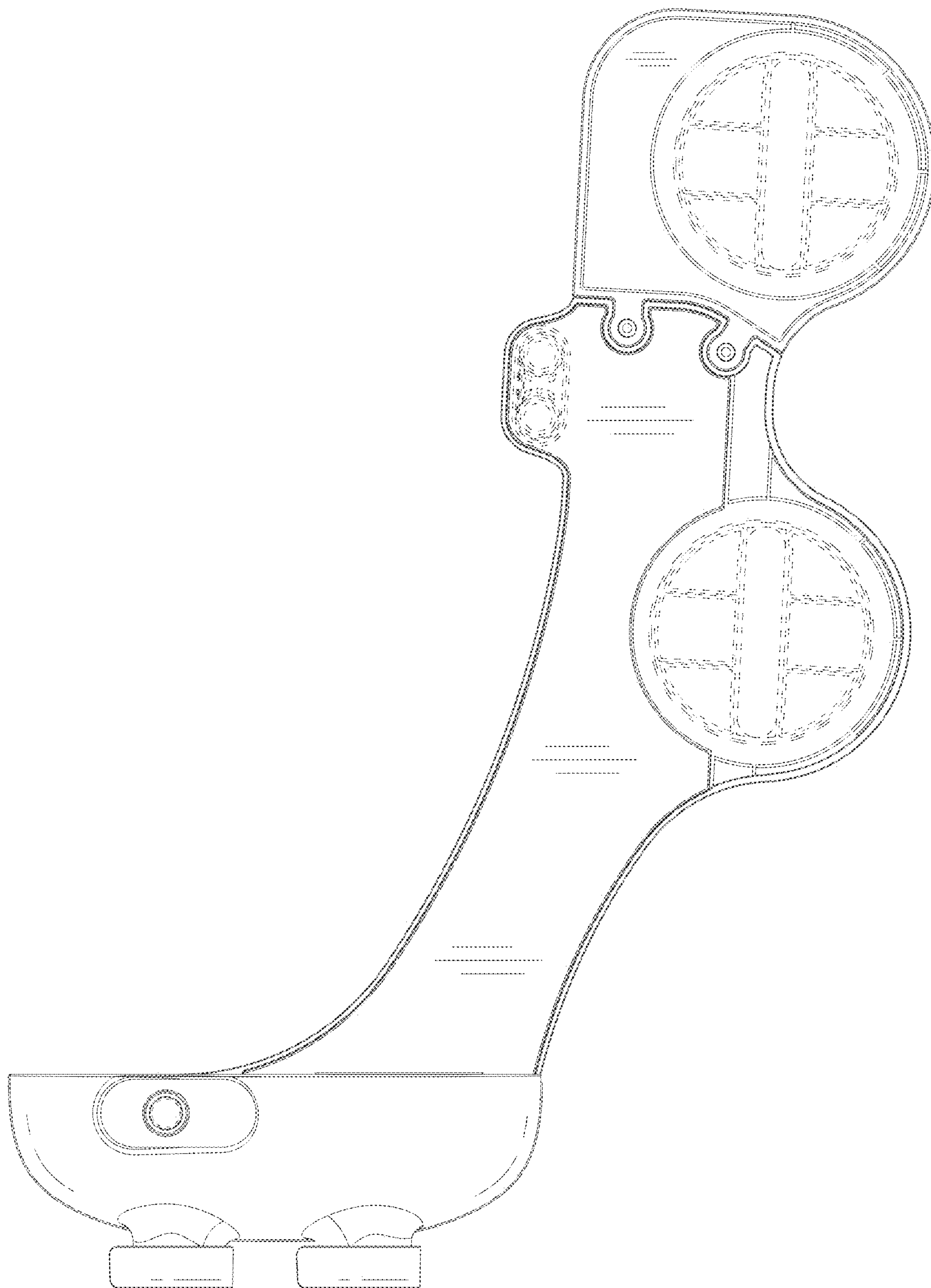

FIG. 2

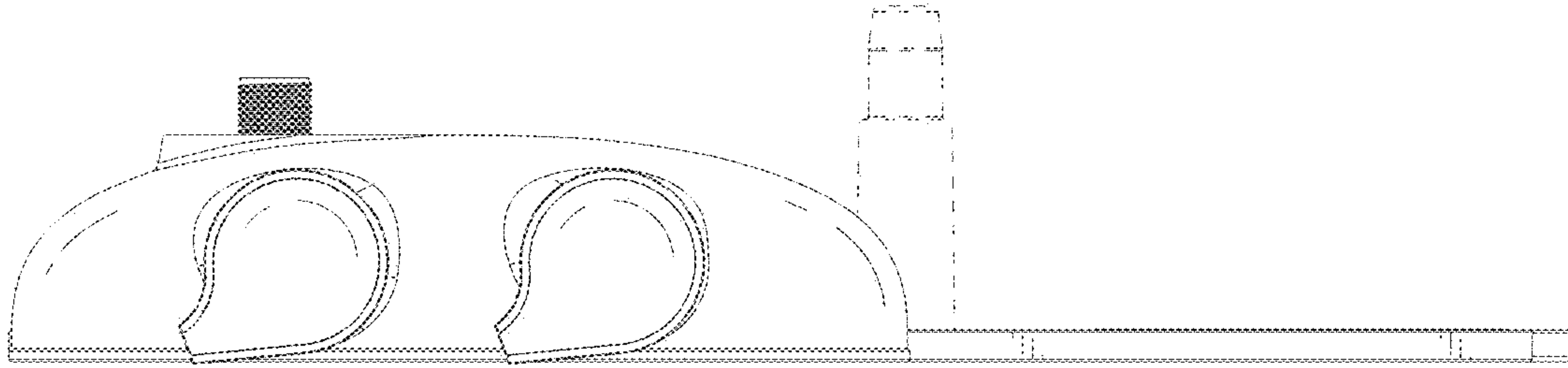

FIG. 3

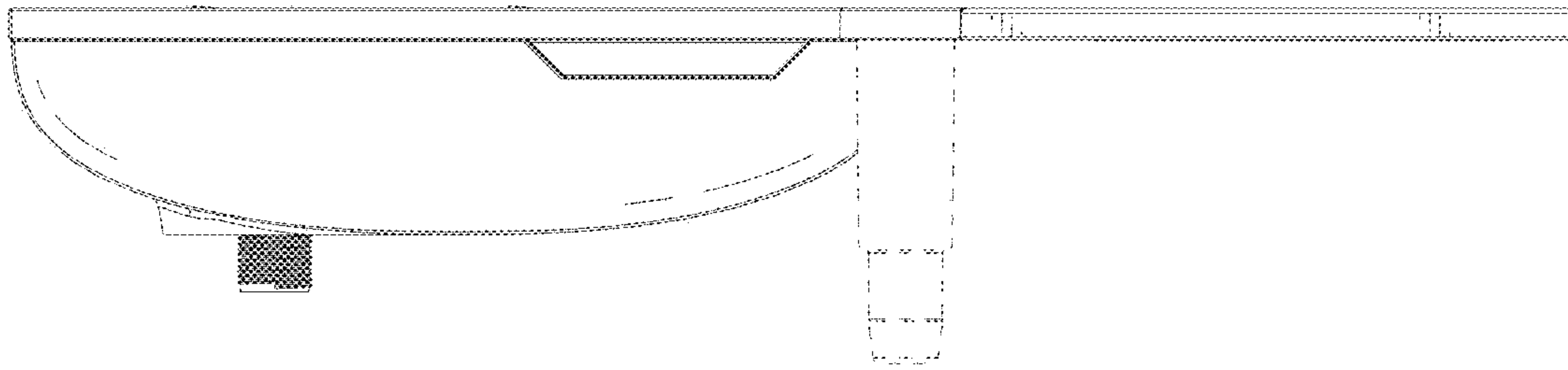

FIG. 4

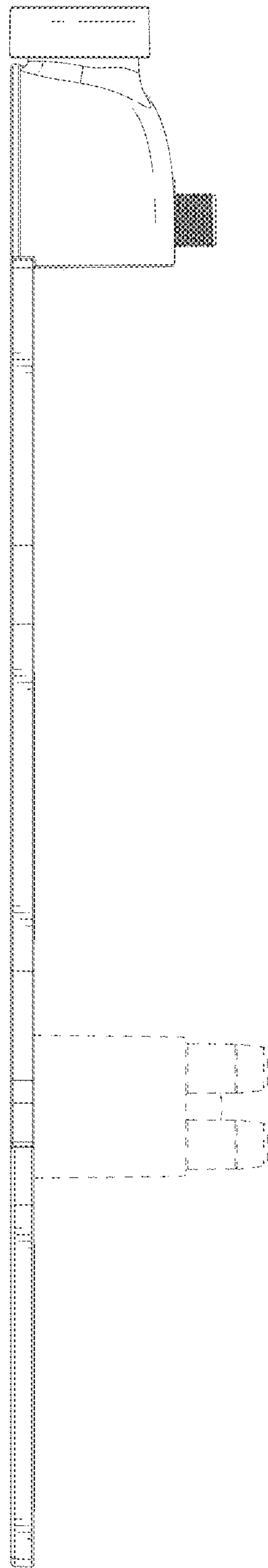

FIG.5

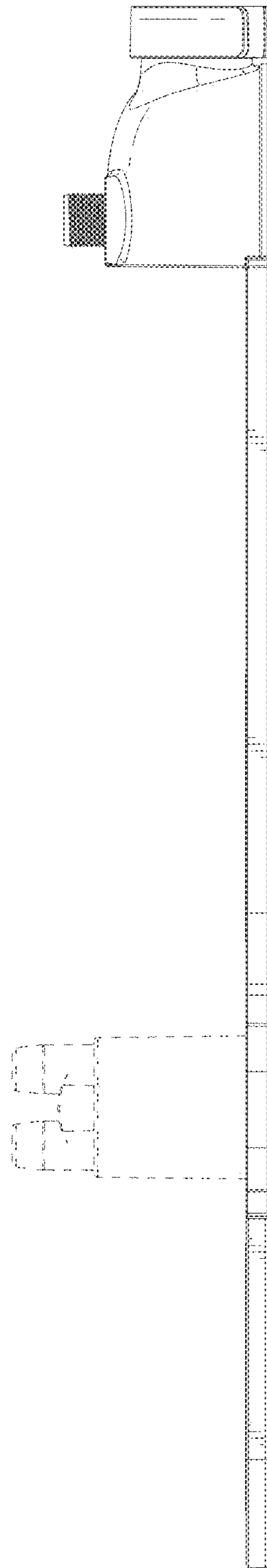

FIG. 6



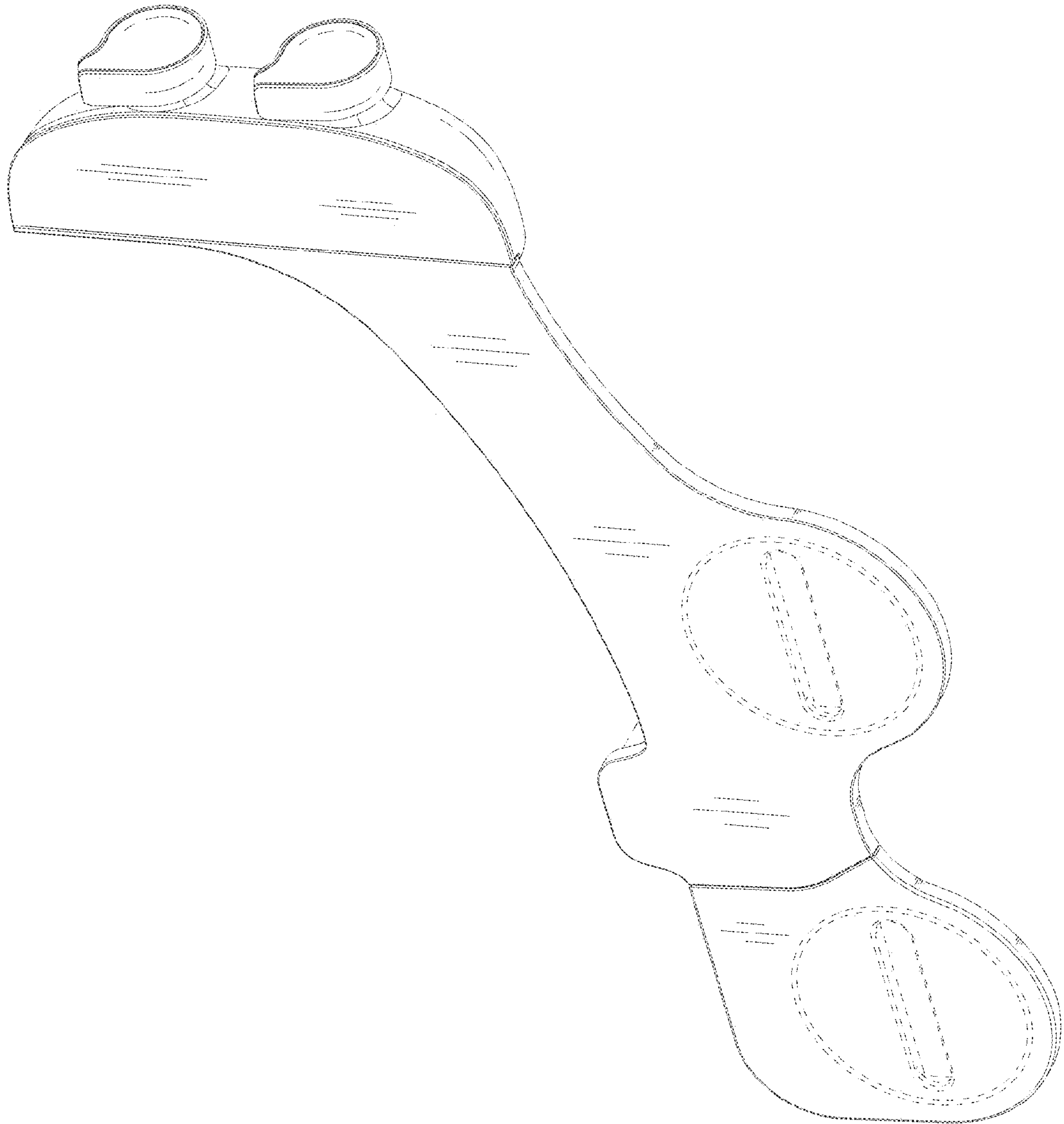

FIG. 7



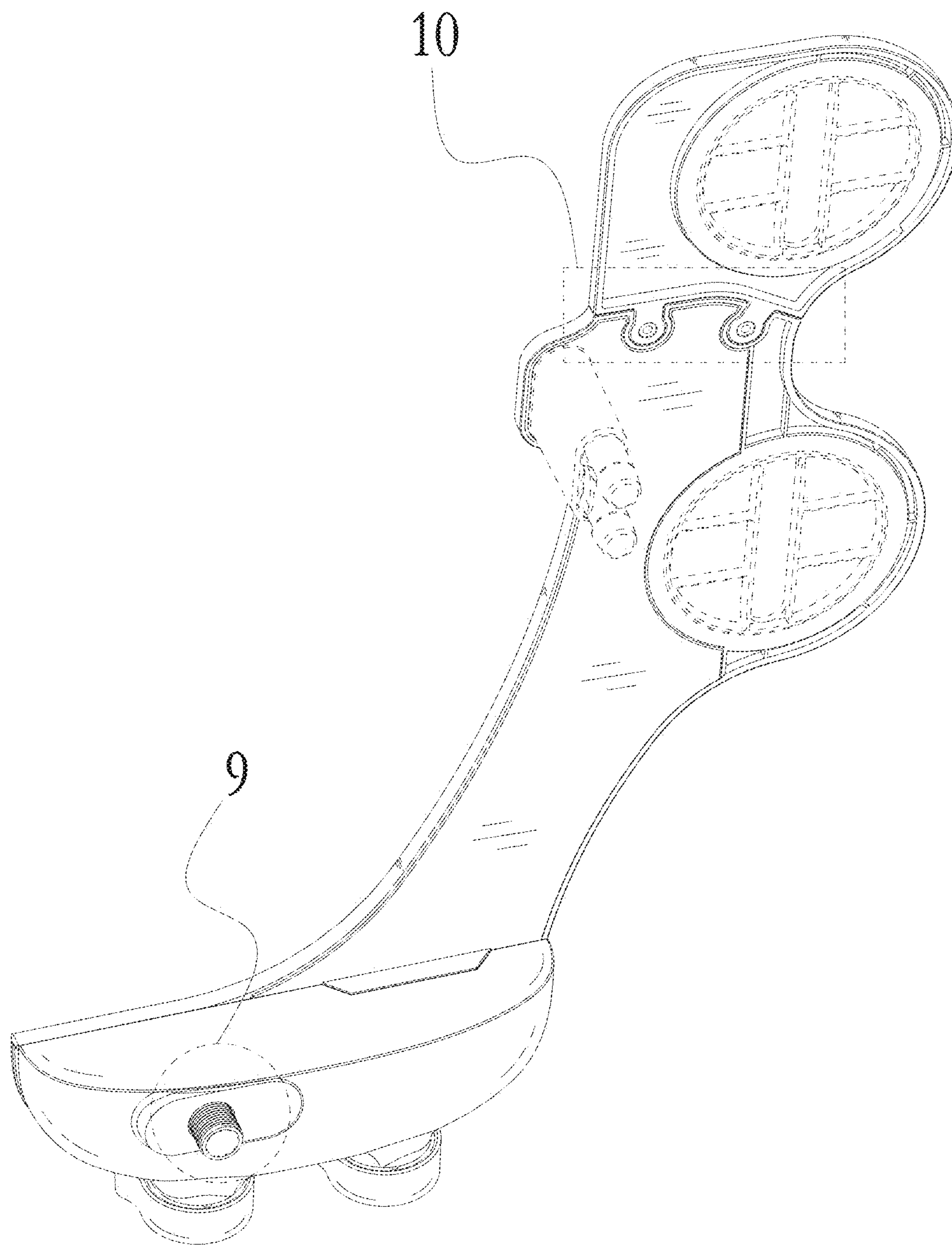

FIG. 8

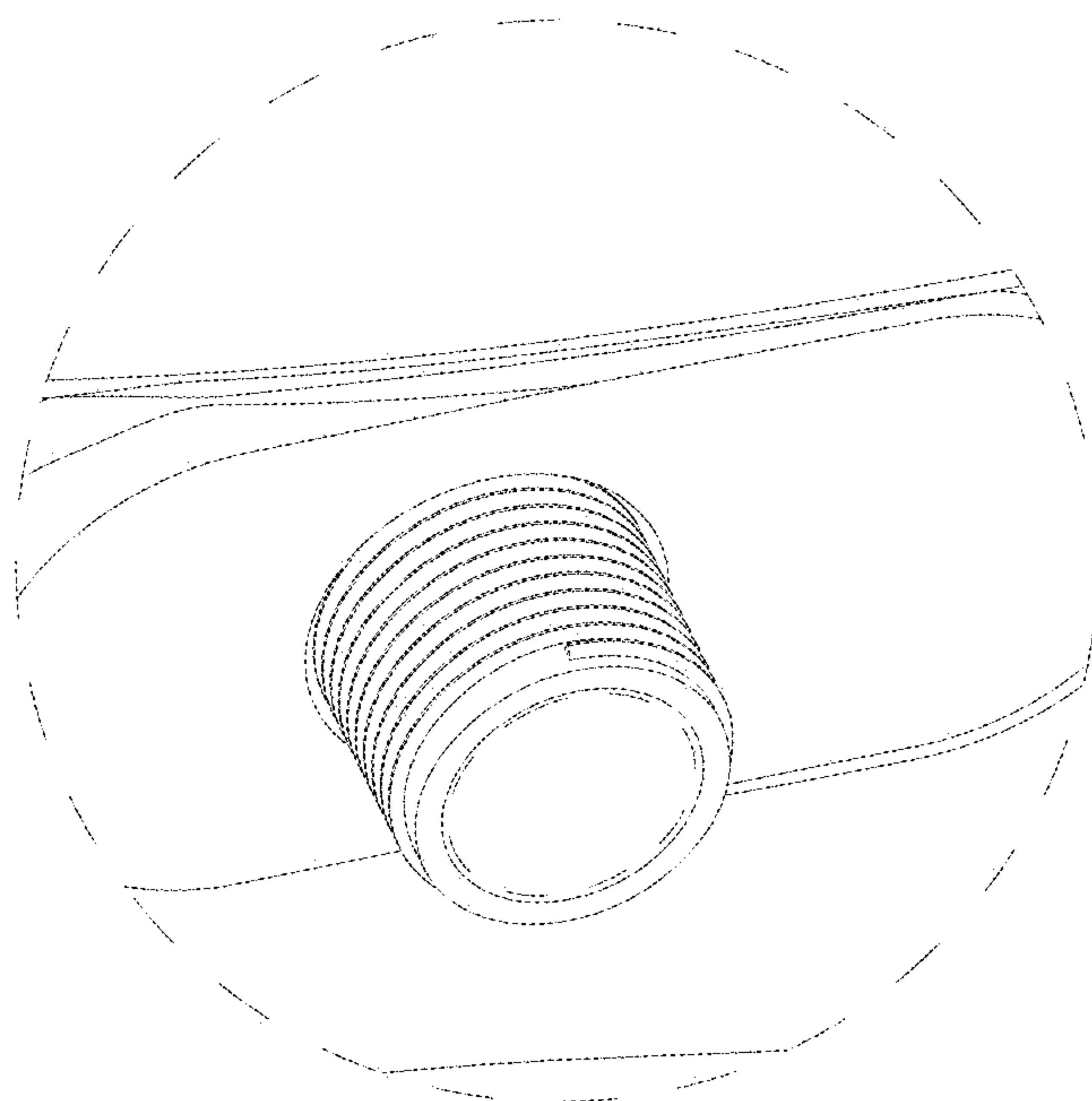

FIG. 9

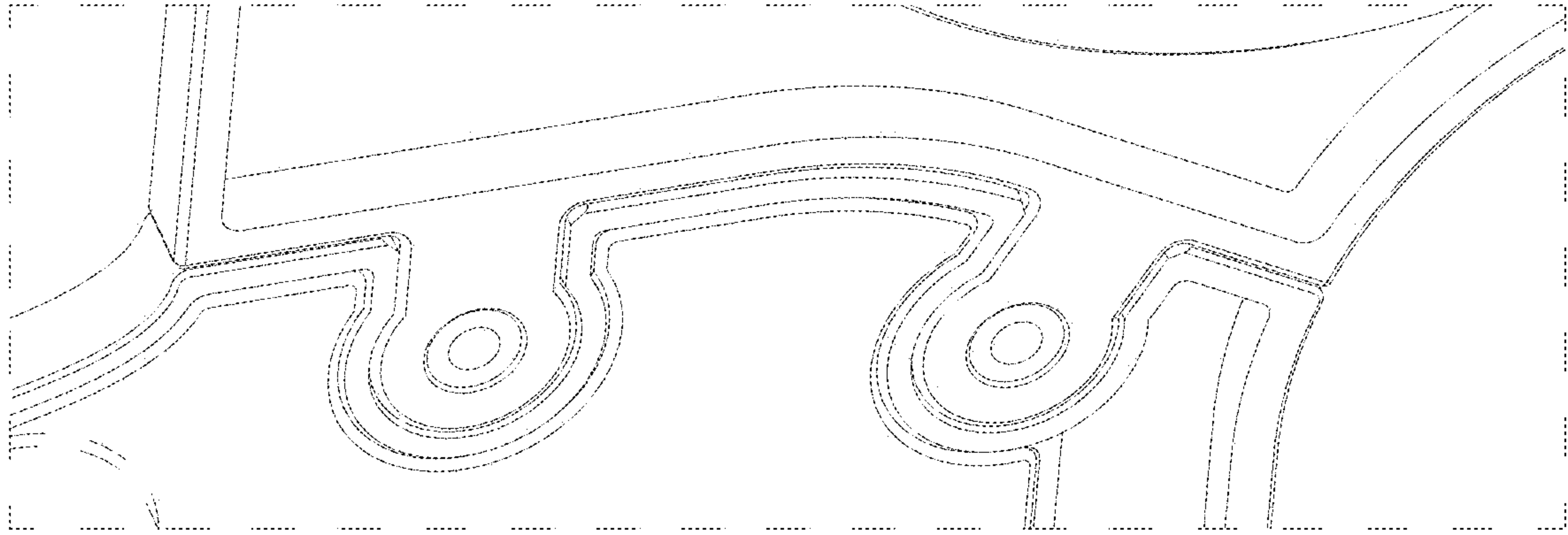

FIG.10

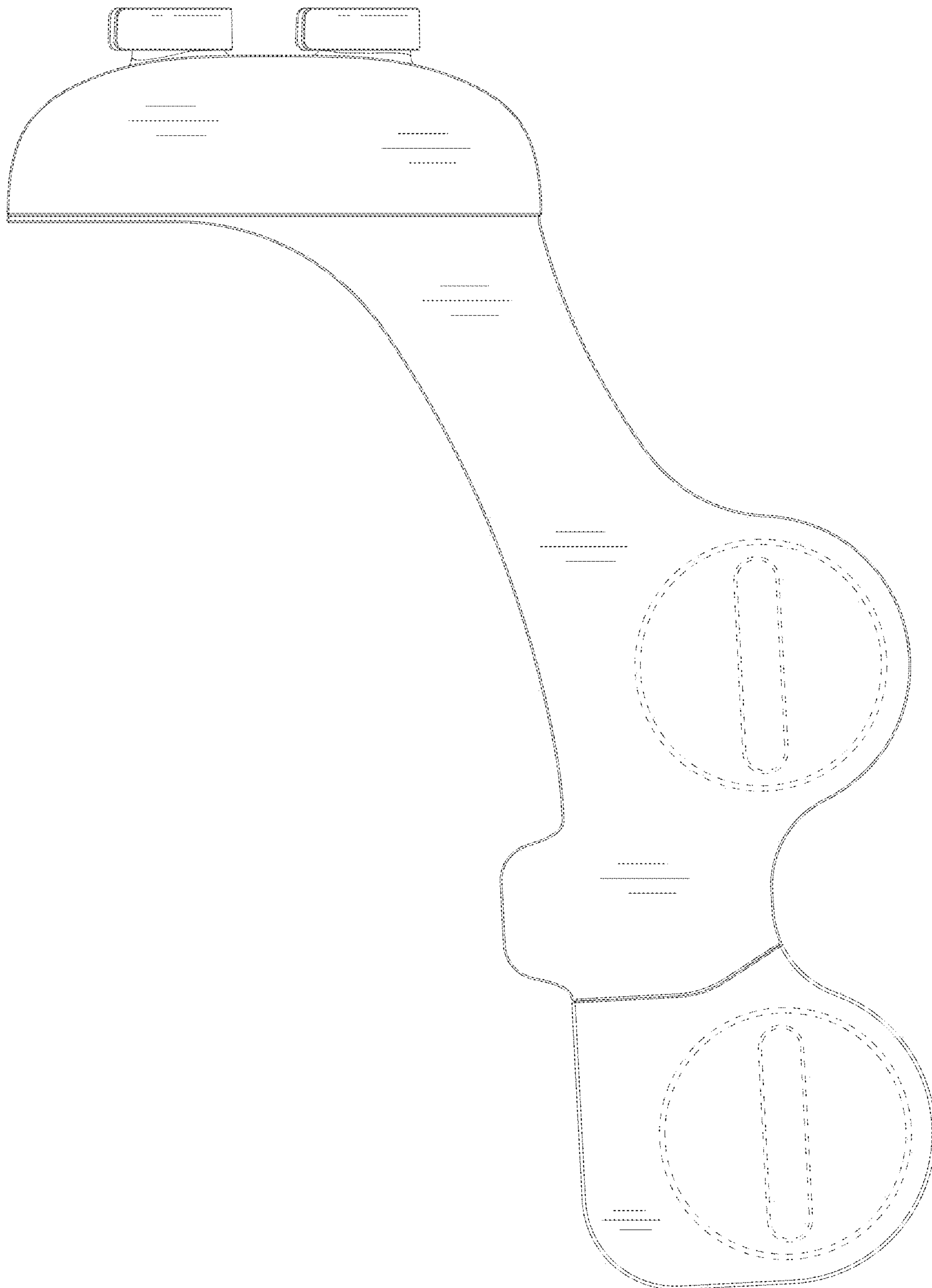

FIG. 11

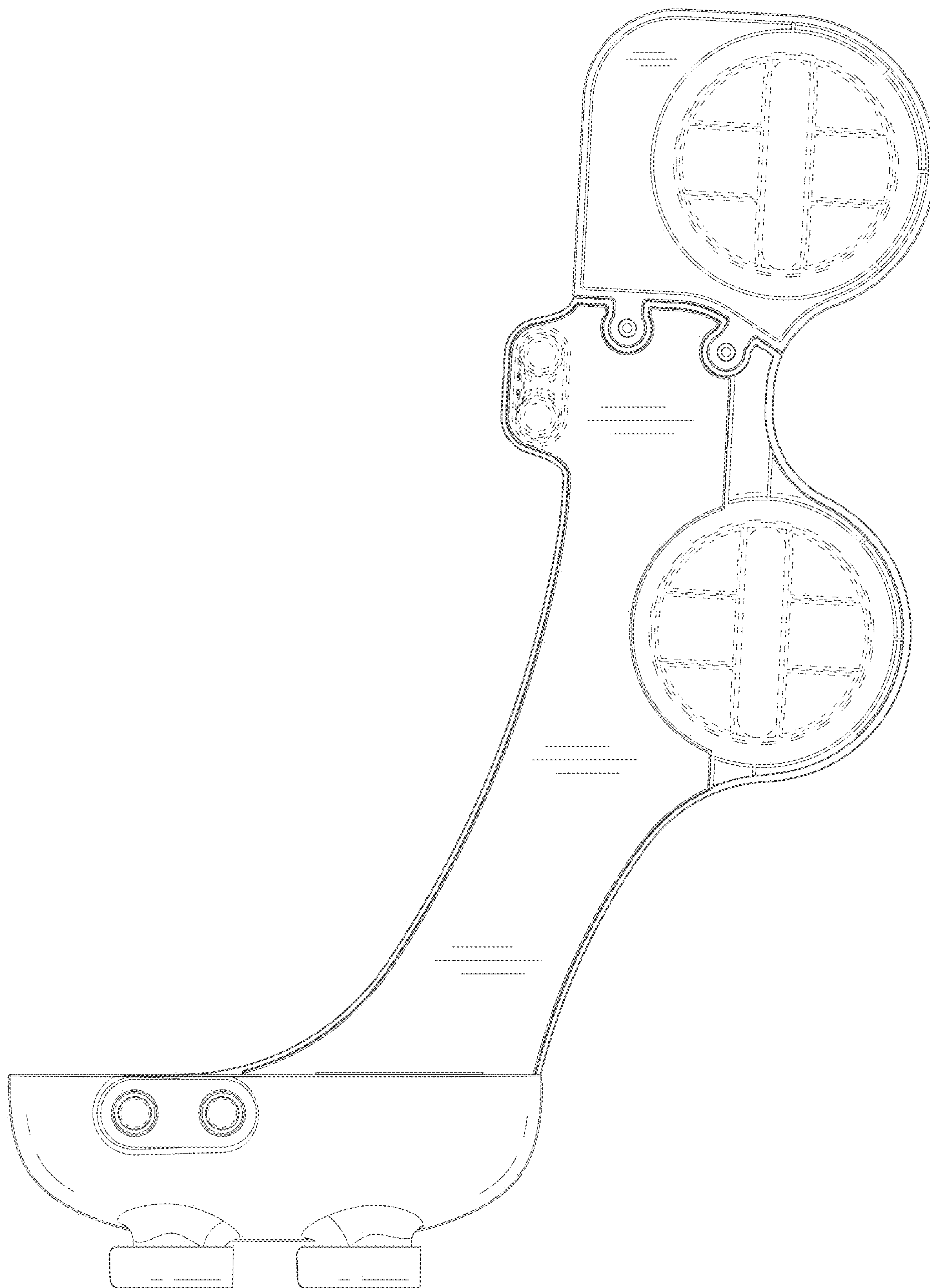

FIG. 12

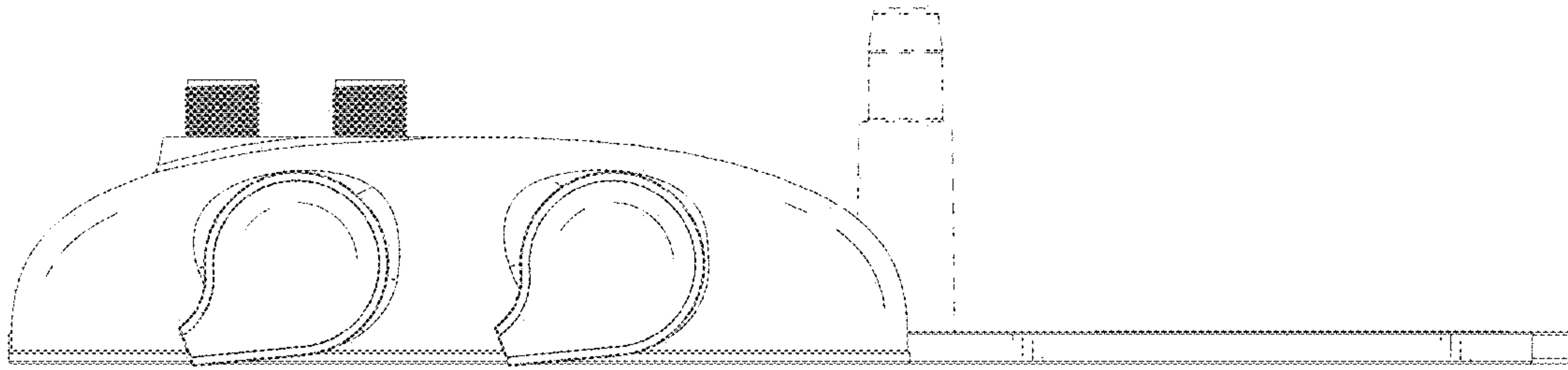

FIG. 13

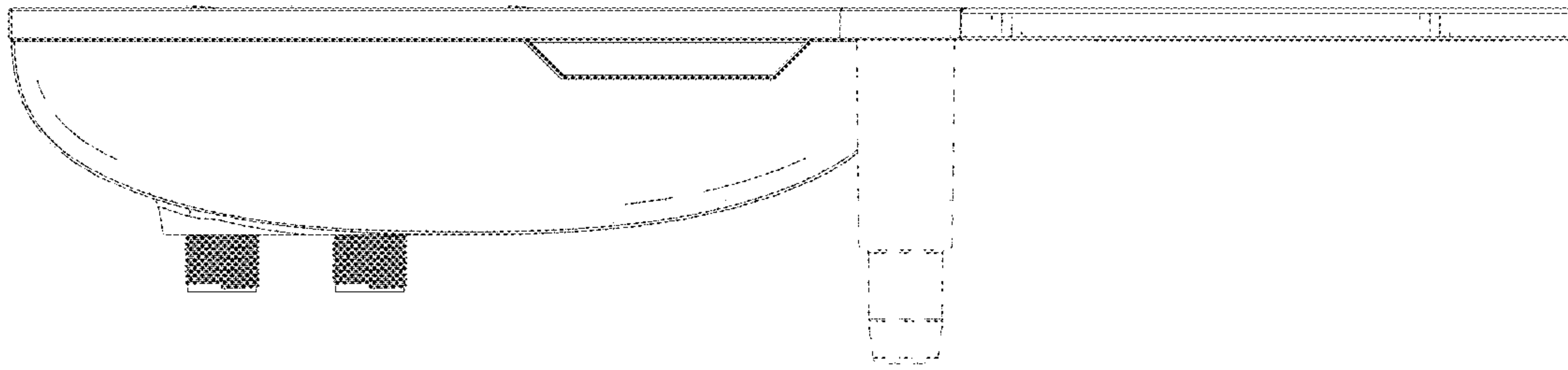

FIG. 14



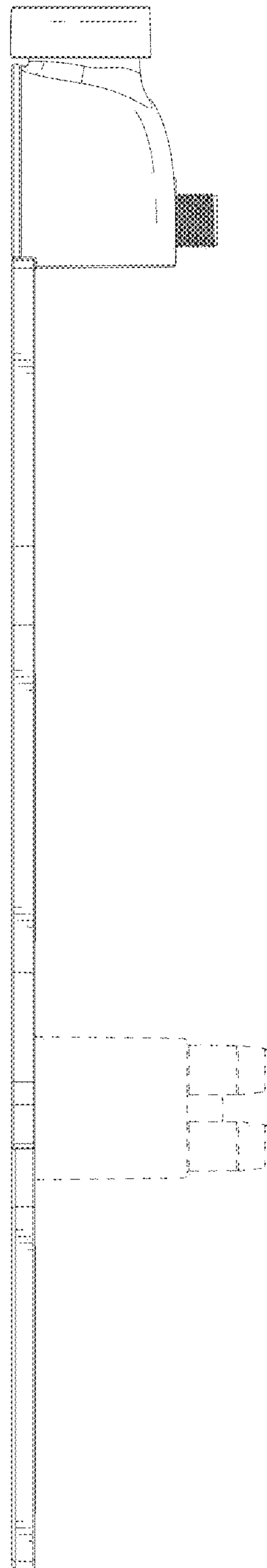

FIG. 15

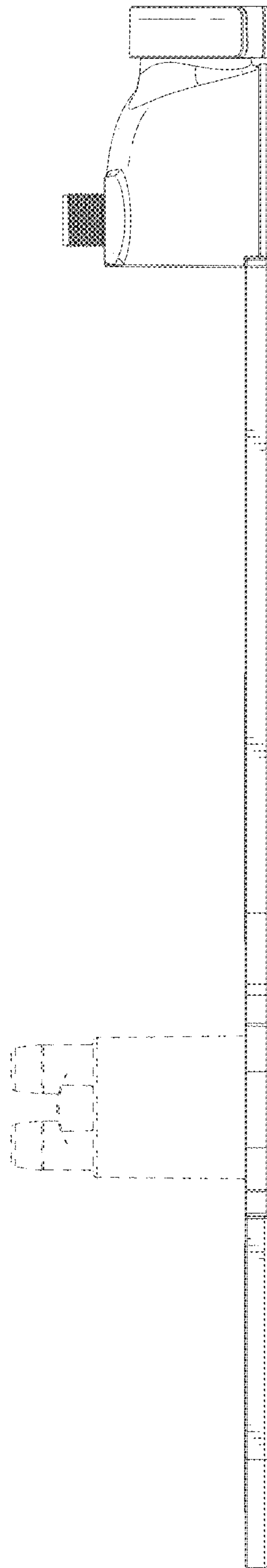

FIG. 16

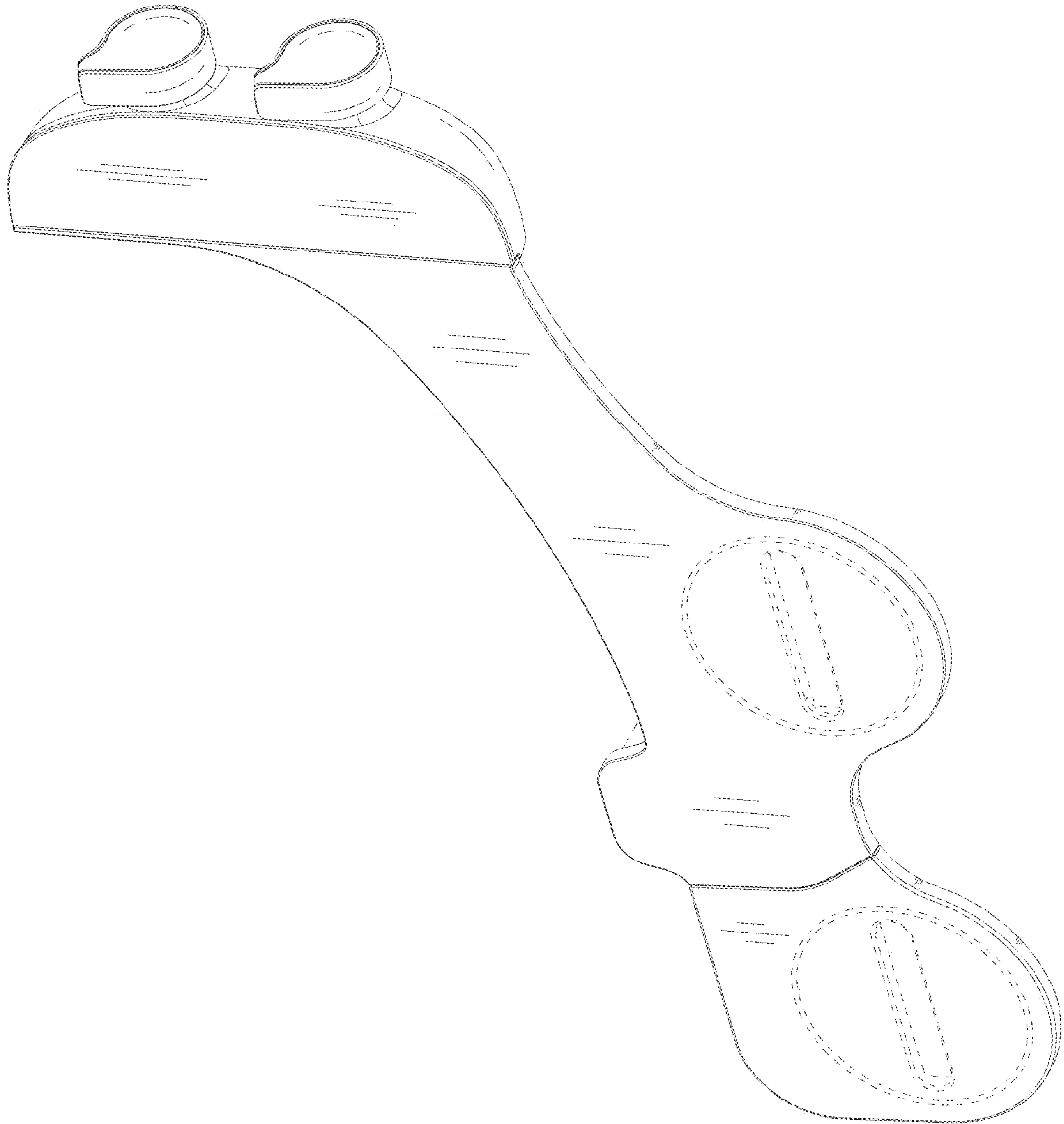

FIG. 17

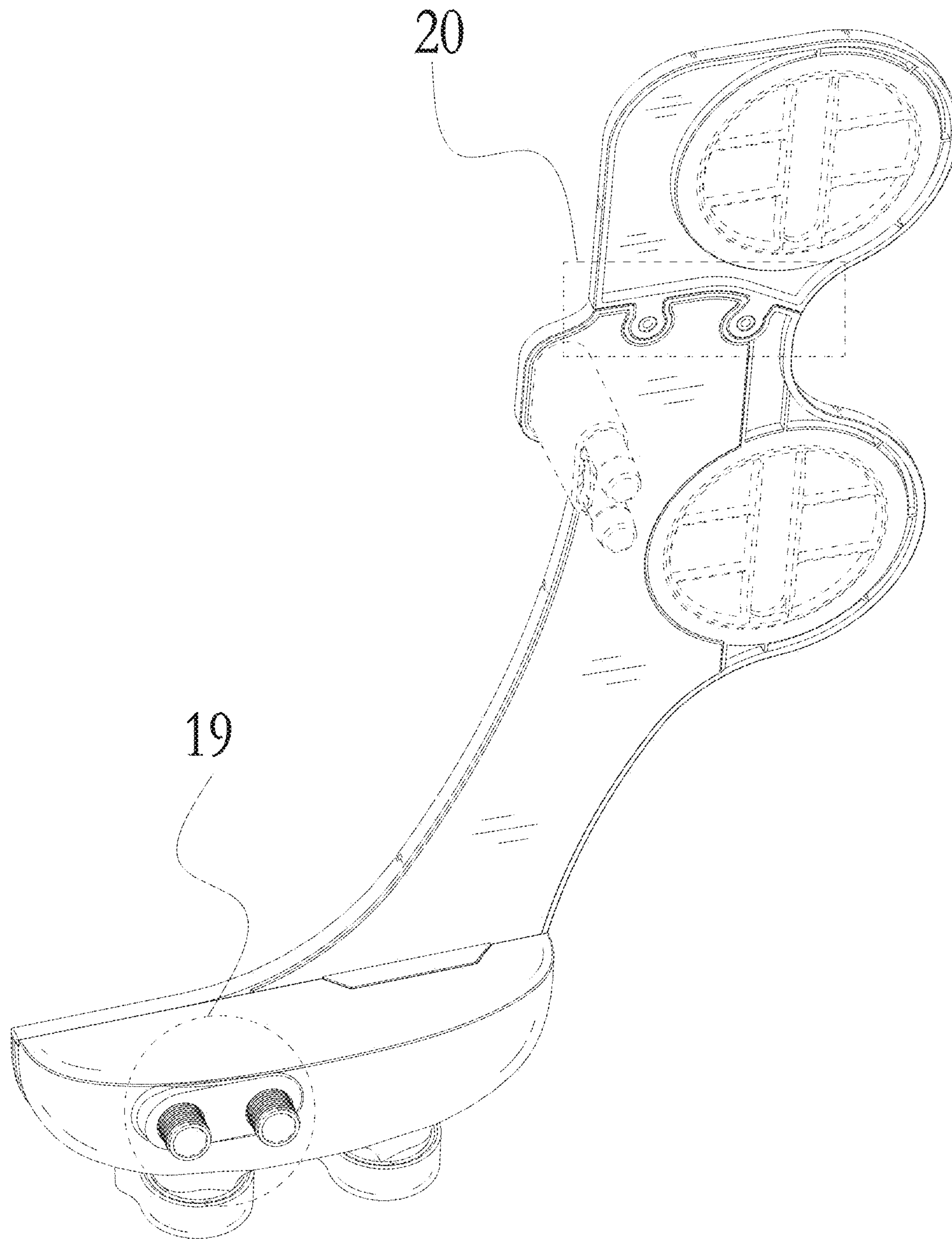

FIG. 18

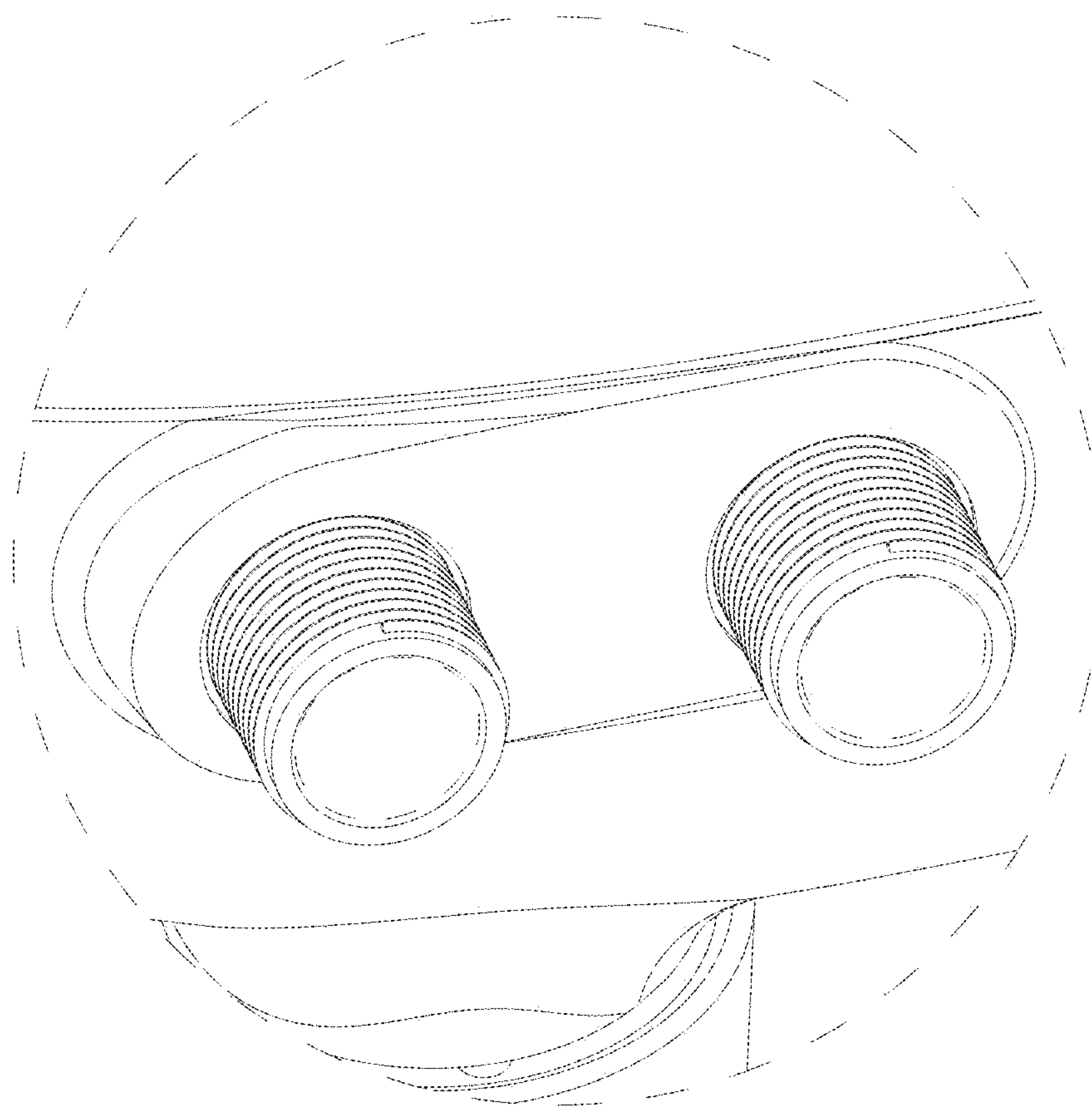

FIG. 19

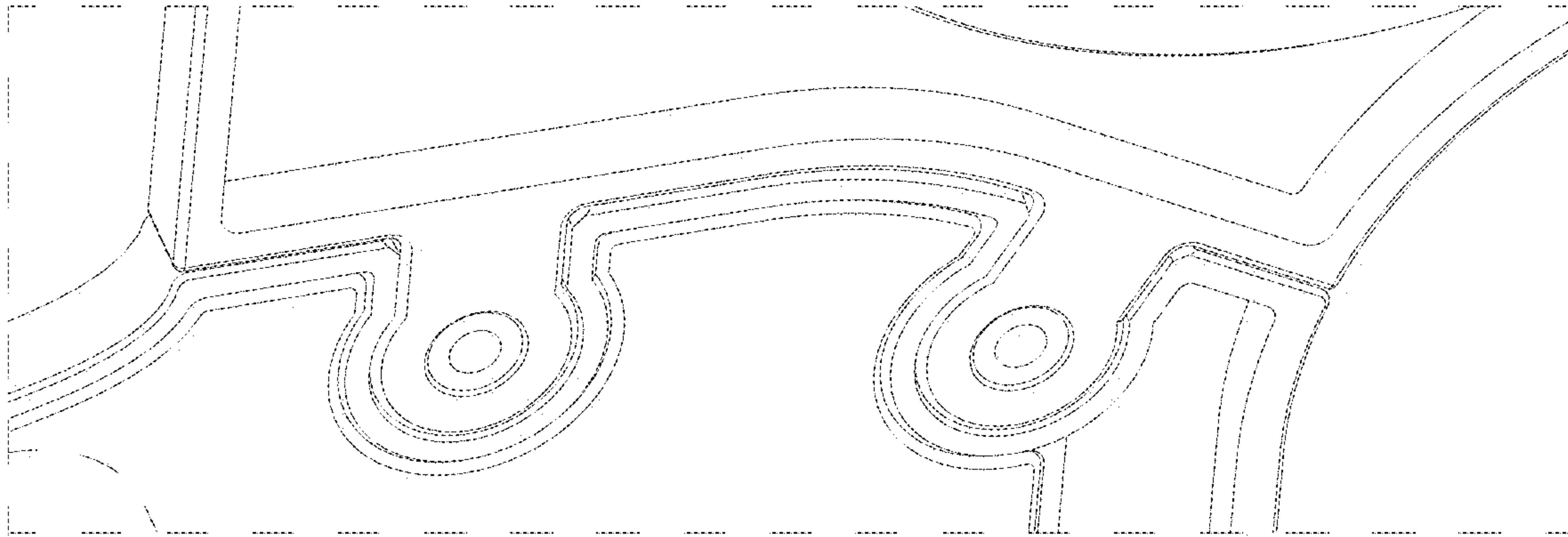

FIG. 20