



US00D982713S

(12) **United States Design Patent**  
**Yan**

(10) **Patent No.:** **US D982,713 S**  
(45) **Date of Patent:** **\*\* Apr. 4, 2023**

(54) **SHOWER HEAD**

FOREIGN PATENT DOCUMENTS

(71) Applicant: **XIAMEN GALENPOO KITCHEN & BATHROOM TECHNOLOGY CO., LTD**, Xiamen (CN)

EM 008615967-0002 \* 7/2021

(72) Inventor: **Xiaoling Yan**, Xiamen (CN)

OTHER PUBLICATIONS

(73) Assignee: **XIAMEN GALENPOO KITCHEN & BATHROOM TECHNOLOGY CO., LTD**, Xiamen (CN)

High Pressure Shower Head with Handheld, 9 Functions Handheld Shower Head Set, High Flow Even with Low Water Pressure Hand Held Showerhead Set with 59 Inch Hose Bracket Teflon Tape Rubber Washers, Date First Available: Jun. 27, 2021, site visited Nov. 28, 2022 [https://www.amazon.com/dp/B093F88K65/ref=sspa\\_dk\\_detail\\_5?psc=1&pd\\_rd\\_i=B093F88K65&pd\\_rd\\_w=R0d9k&content-id=amzn1.sym.46bad5f6-1f0a-4167-9a8b-c8a82fa48a54&pf\\_rd\\_p=46bad5f6-1f0a-4167-9a8b-c8a82fa48a54&pf\\_rd\\_r=6AWDXXJBRFE5APHMG6FD&pd\\_rd\\_wg=vOSsQ&pd\\_rd\\_r=c40ce093-5538-4639-867f-afe67791cc0b&s=hi&sp\\_csd=d2lkZ2V0TmFtZT1zcF9kZXRhaWw&spLa=ZW5jenlwdGVkUXVhbGlmaWVyPUExOVdHODc0UTUzRFRCJmVuY3J5cHRIZEIkPUeWNTAxNzcxMkk0MFpKTkVIUkhZWSZ3aWRnZXROYW1IPXNwX2RldGFpbCZhY3Rpb249Y2xpY2tSZWRpcmVjdCZkb05vdExvZ0NsaWNrPXRydWU=](https://www.amazon.com/dp/B093F88K65/ref=sspa_dk_detail_5?psc=1&pd_rd_i=B093F88K65&pd_rd_w=R0d9k&content-id=amzn1.sym.46bad5f6-1f0a-4167-9a8b-c8a82fa48a54&pf_rd_p=46bad5f6-1f0a-4167-9a8b-c8a82fa48a54&pf_rd_r=6AWDXXJBRFE5APHMG6FD&pd_rd_wg=vOSsQ&pd_rd_r=c40ce093-5538-4639-867f-afe67791cc0b&s=hi&sp_csd=d2lkZ2V0TmFtZT1zcF9kZXRhaWw&spLa=ZW5jenlwdGVkUXVhbGlmaWVyPUExOVdHODc0UTUzRFRCJmVuY3J5cHRIZEIkPUeWNTI1NTQ2MIEVVhVSIc0NIVSQiZlbnNyeXB0ZWRBZEIkPUeWNTAxNzcxMkk0MFpKTkVIUkhZWSZ3aWRnZXROYW1IPXNwX2RldGFpbCZhY3Rpb249Y2xpY2tSZWRpcmVjdCZkb05vdExvZ0NsaWNrPXRydWU=) (Year: 2021).\*

(\*\*) Term: **15 Years**

(21) Appl. No.: **29/854,686**

(22) Filed: **Sep. 27, 2022**

(51) **LOC (14) Cl.** ..... **23-01**

(52) **U.S. Cl.**  
USPC ..... **D23/213**

(58) **Field of Classification Search**  
USPC ..... D23/213, 214–221, 222–223, 226, 228, D23/229, 230, 238–242, 249  
CPC ..... A61H 9/0021; A61H 33/00; B05B 1/185; B05B 1/08; B05B 1/02; B05B 1/26; B05B 12/002; B05B 1/18; B05B 9/01  
See application file for complete search history.

*Primary Examiner* — Amy C Wierenga  
*Assistant Examiner* — Andrea Marie McKay  
(74) *Attorney, Agent, or Firm* — Nitin Kaushik

(57) **CLAIM**

The ornamental design for a shower head, as shown and described.

(56) **References Cited**

**DESCRIPTION**

U.S. PATENT DOCUMENTS

D667,928 S \* 9/2012 Cutler ..... D23/223  
D889,602 S \* 7/2020 Wu ..... B05B 15/62  
D23/223  
D889,603 S \* 7/2020 Wu ..... D23/223  
D901,630 S \* 11/2020 Wu ..... E03C 1/06  
D23/213  
D908,839 S \* 1/2021 Wu ..... D23/223  
D908,840 S \* 1/2021 Wu ..... B05B 12/04  
D23/223  
D917,663 S \* 4/2021 Yan ..... D23/223  
D931,411 S \* 9/2021 Yan ..... D23/213

FIG. 1 is a front perspective view of a shower head, showing my new design;  
FIG. 2 is a rear perspective view thereof;  
FIG. 3 is a front view thereof;  
FIG. 4 is a rear view thereof;  
FIG. 5 is a left side view thereof;  
FIG. 6 is a right side view thereof;  
FIG. 7 is a top view thereof;  
FIG. 8 is a bottom view thereof;  
FIG. 9 is an enlarged detail view of the selected portion 9 in FIG. 1; and,

(Continued)

(Continued)

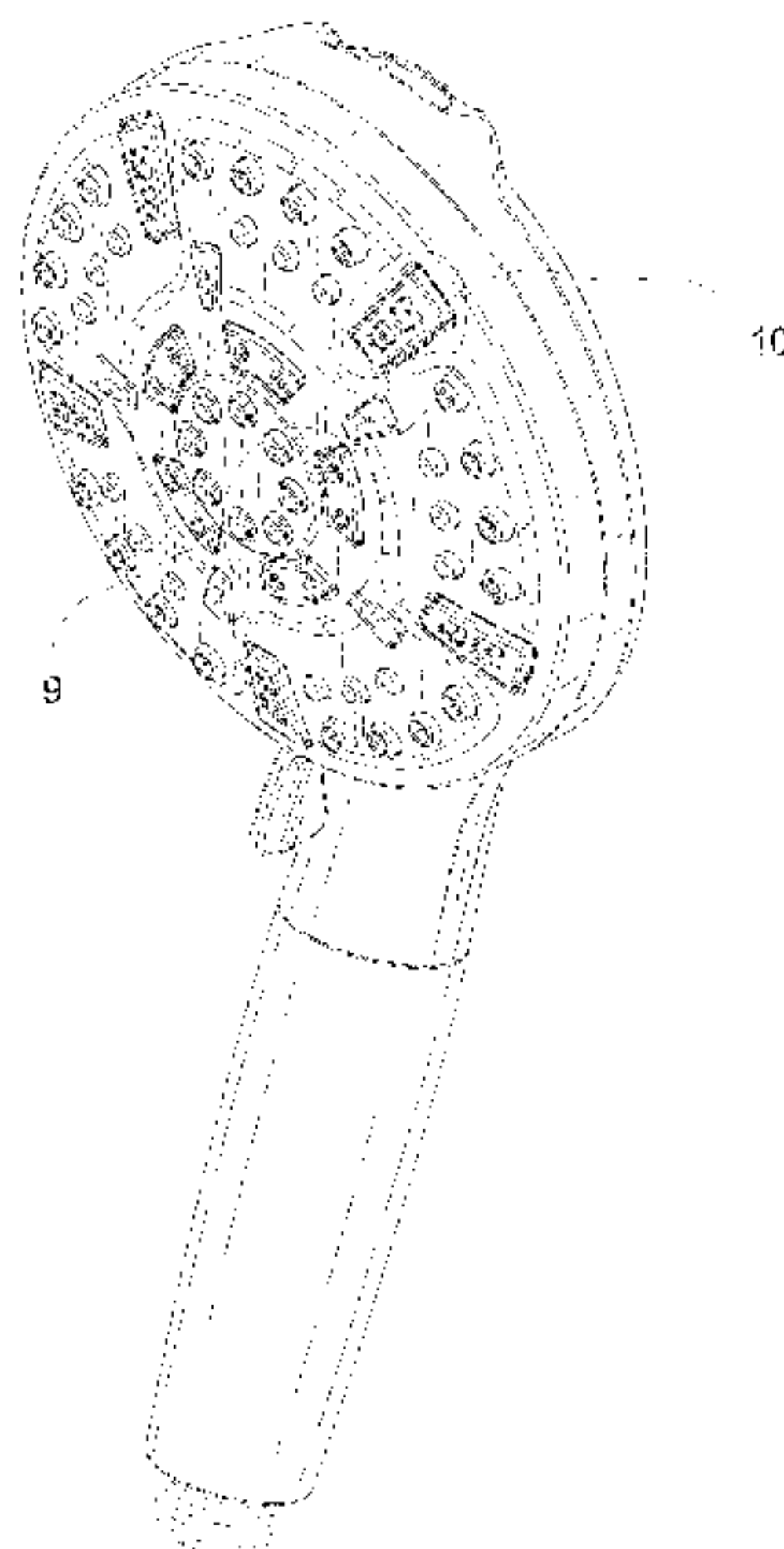

FIG. 10 is an enlarged detail view of the selected portion 10 in FIG. 1.

The dashed broken lines depict portions of the shower head that form no part of the claim.

The long dash-short-dash broken lines shown in FIGS. 1 and 9-10 indicate cutoff boundaries for the enlarged detailed portion views and form no part of the claim.

**1 Claim, 10 Drawing Sheets**

(56)

**References Cited**

U.S. PATENT DOCUMENTS

D933,778	S	*	10/2021	Salvador	.....	D23/213
D934,381	S	*	10/2021	Salvador	.....	D23/213
D935,557	S	*	11/2021	Yan	.....	D23/213
D936,178	S	*	11/2021	Lin	.....	D23/213
D943,062	S	*	2/2022	Fan	.....	D23/223
D958,290	S	*	7/2022	Corpuz, Jr.	.....	D23/213
D961,047	S	*	8/2022	Ruan	.....	D23/223
D961,048	S		8/2022	He		
D961,728	S	*	8/2022	Yan	.....	D23/223
2022/0143631	A1	*	5/2022	Fan	.....	B05B 12/04
2022/0184643	A1	*	6/2022	Zhadanov	.....	B05B 1/1636
2022/0266287	A1	*	8/2022	Shade	.....	E03C 1/06

\* cited by examiner

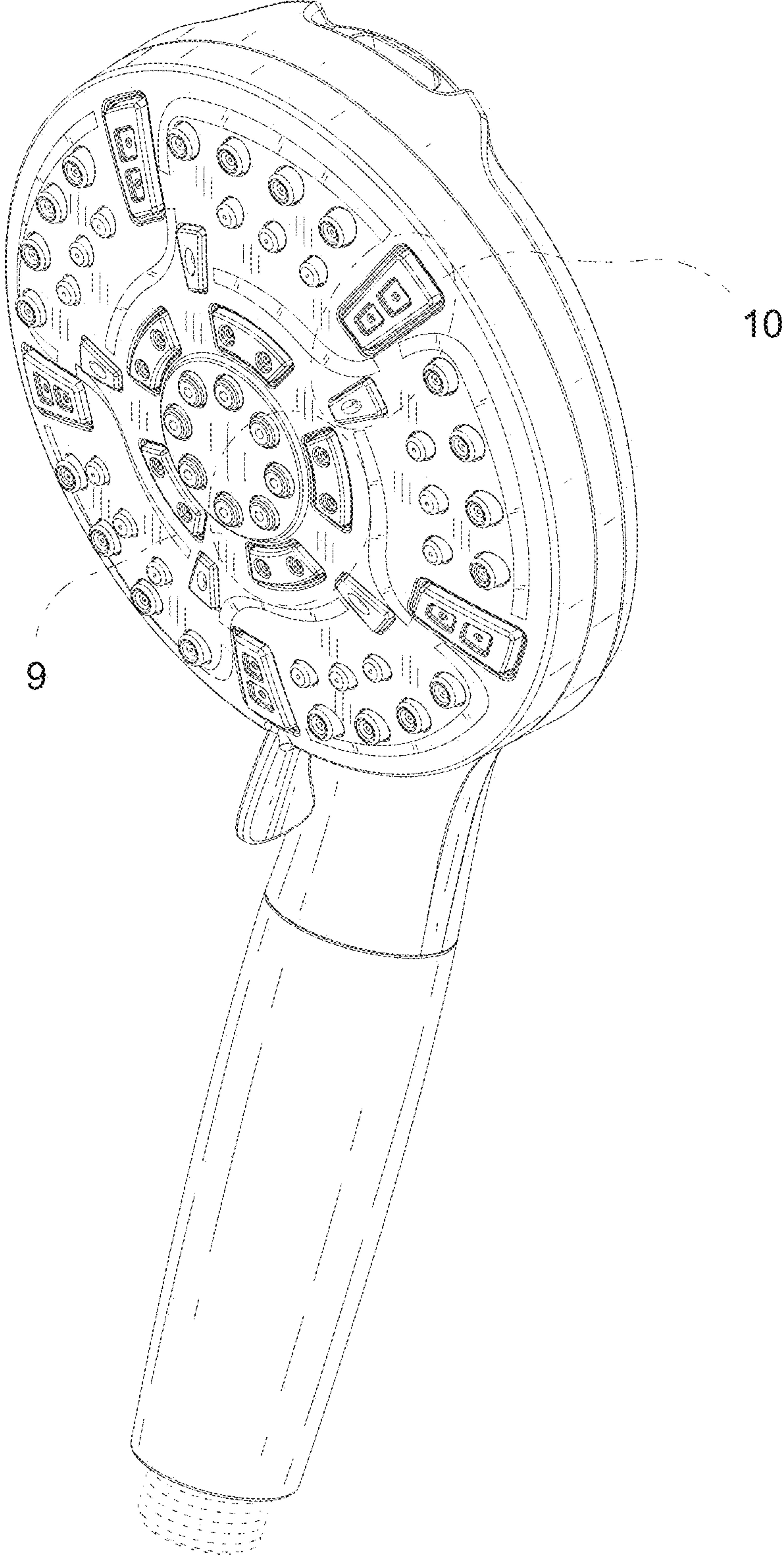

FIG. 1

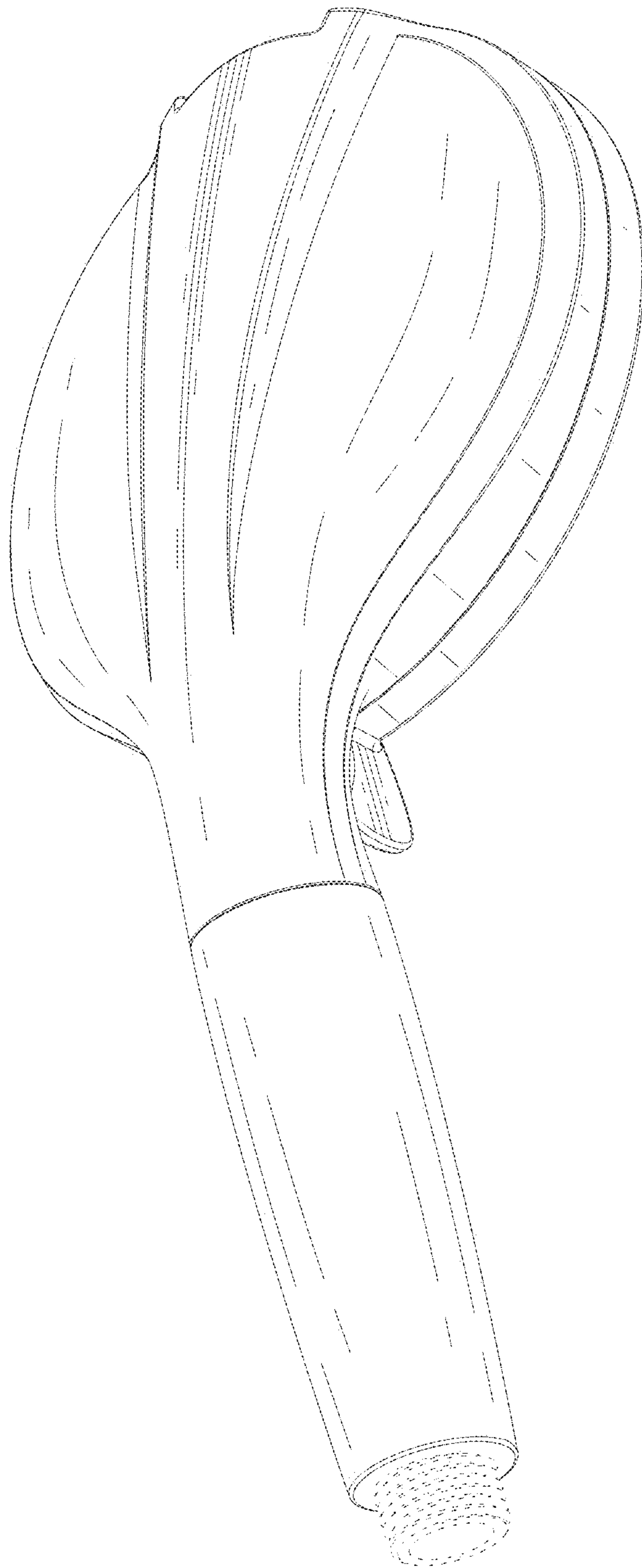

FIG. 2



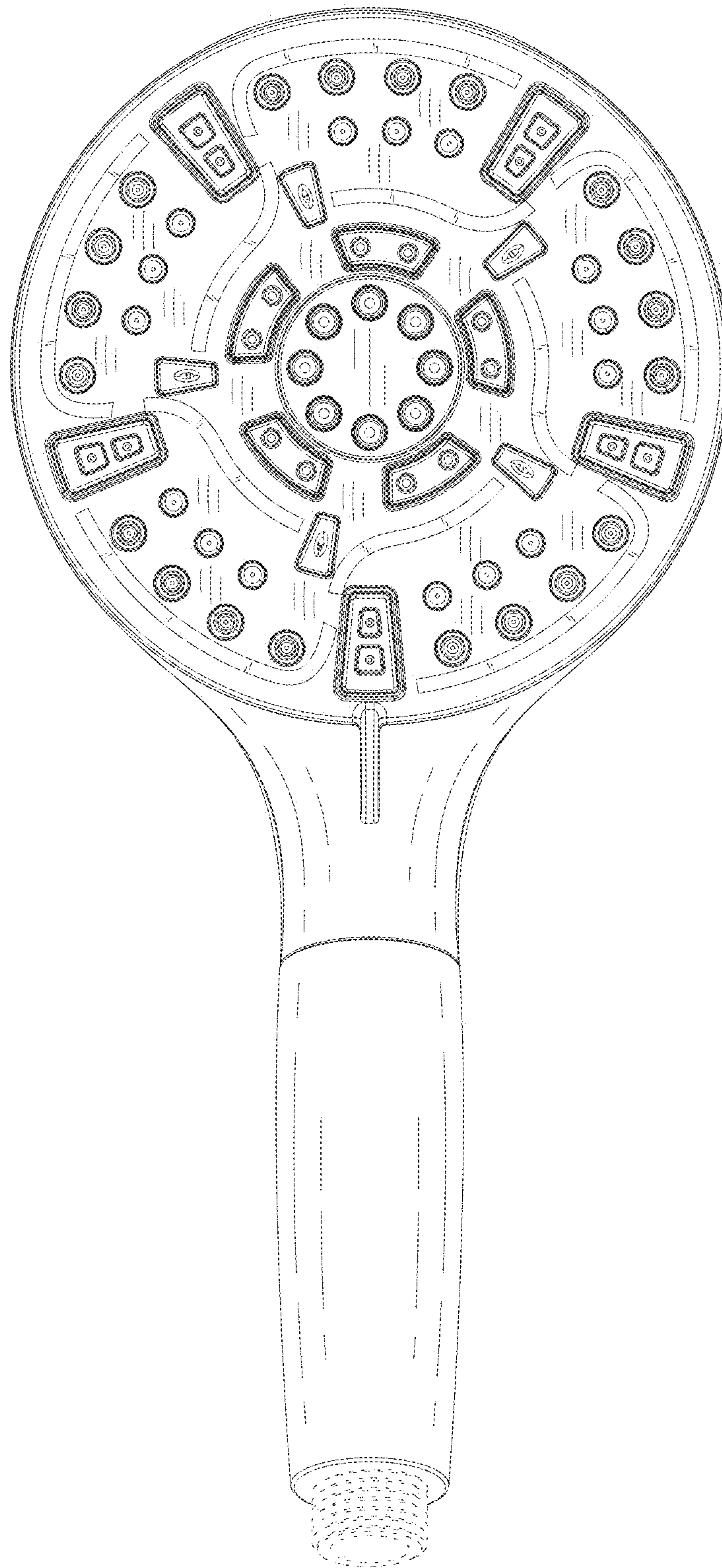

FIG. 3

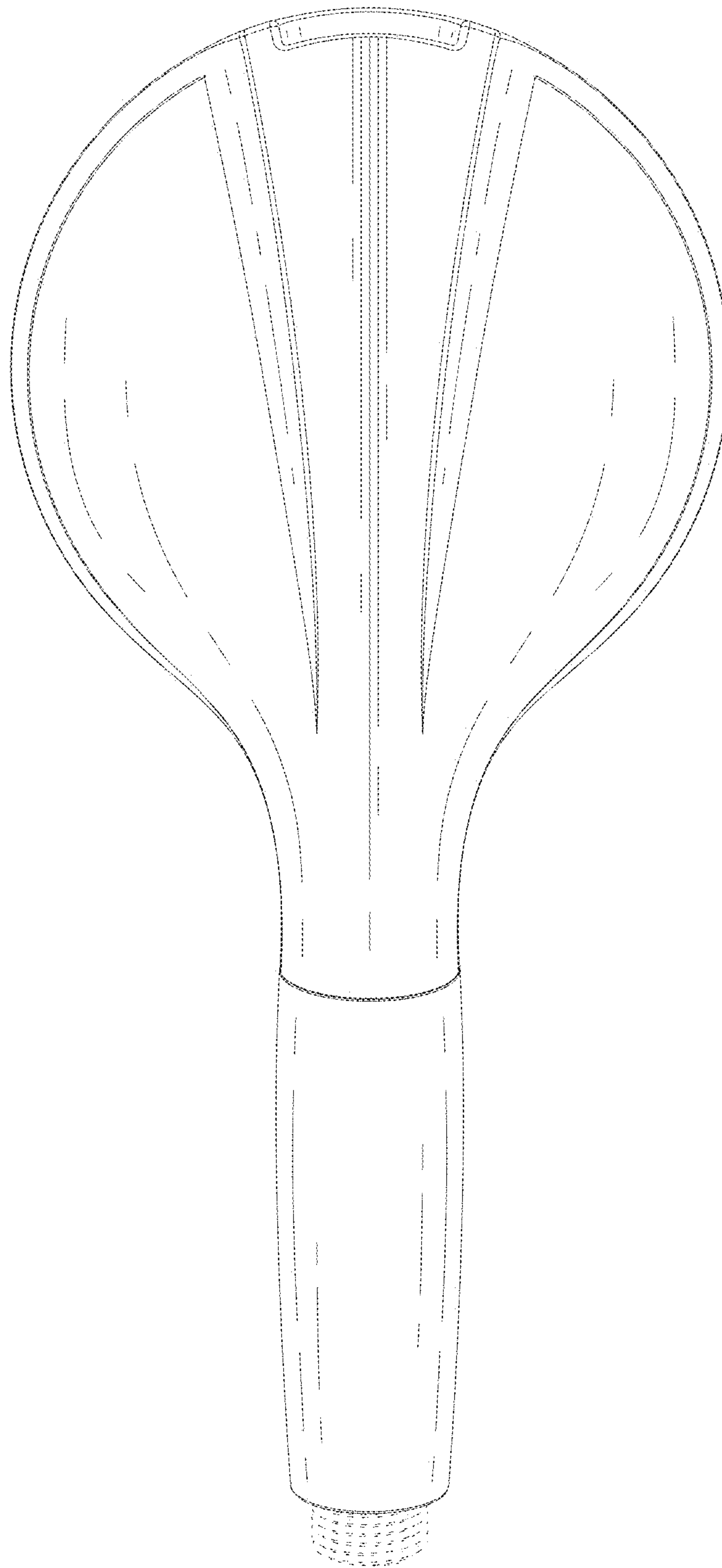

FIG. 4

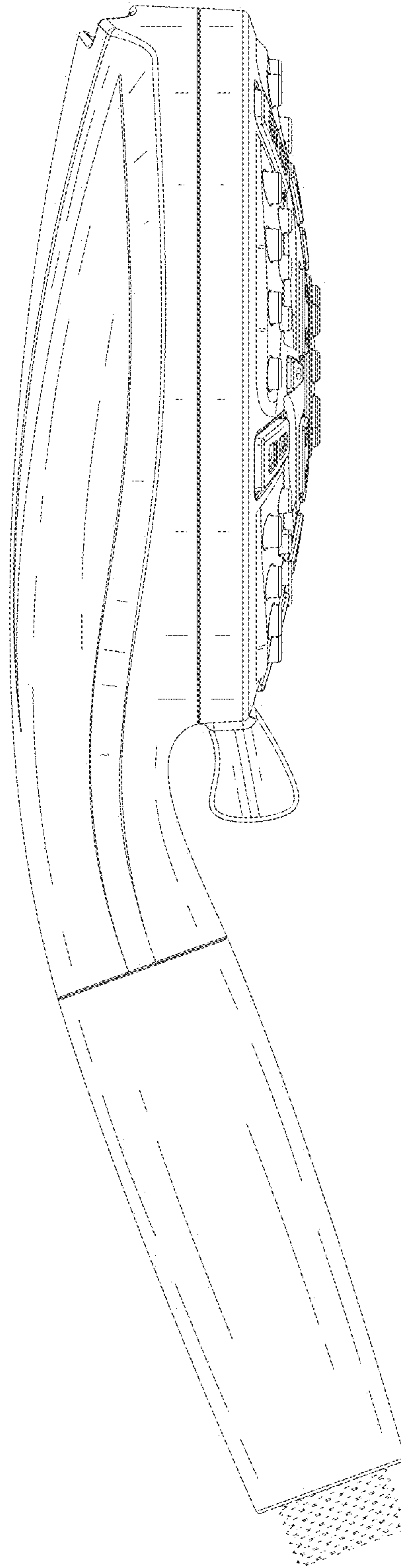

FIG. 5

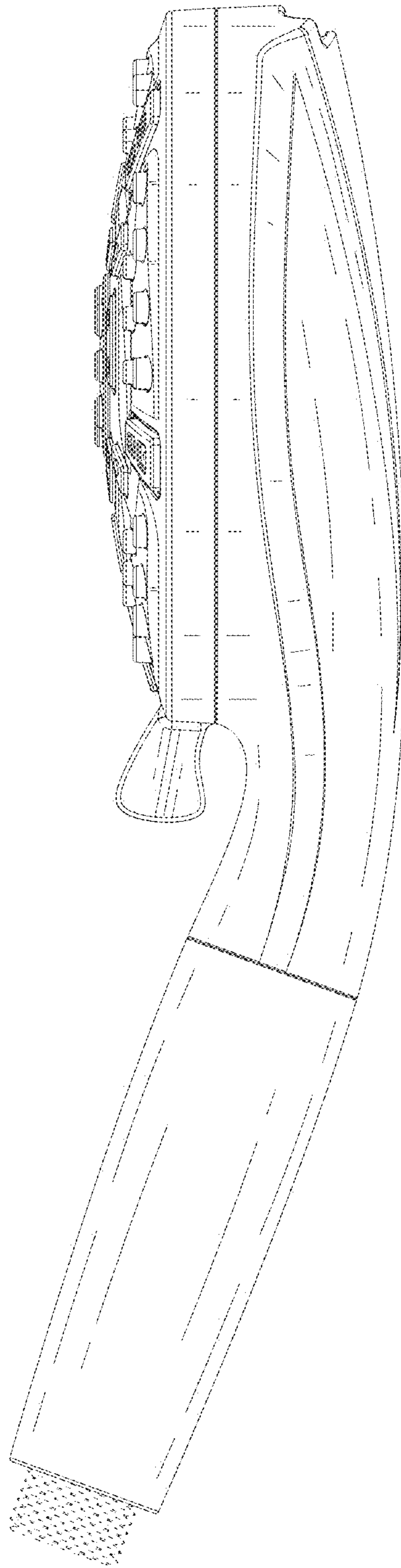

FIG. 6



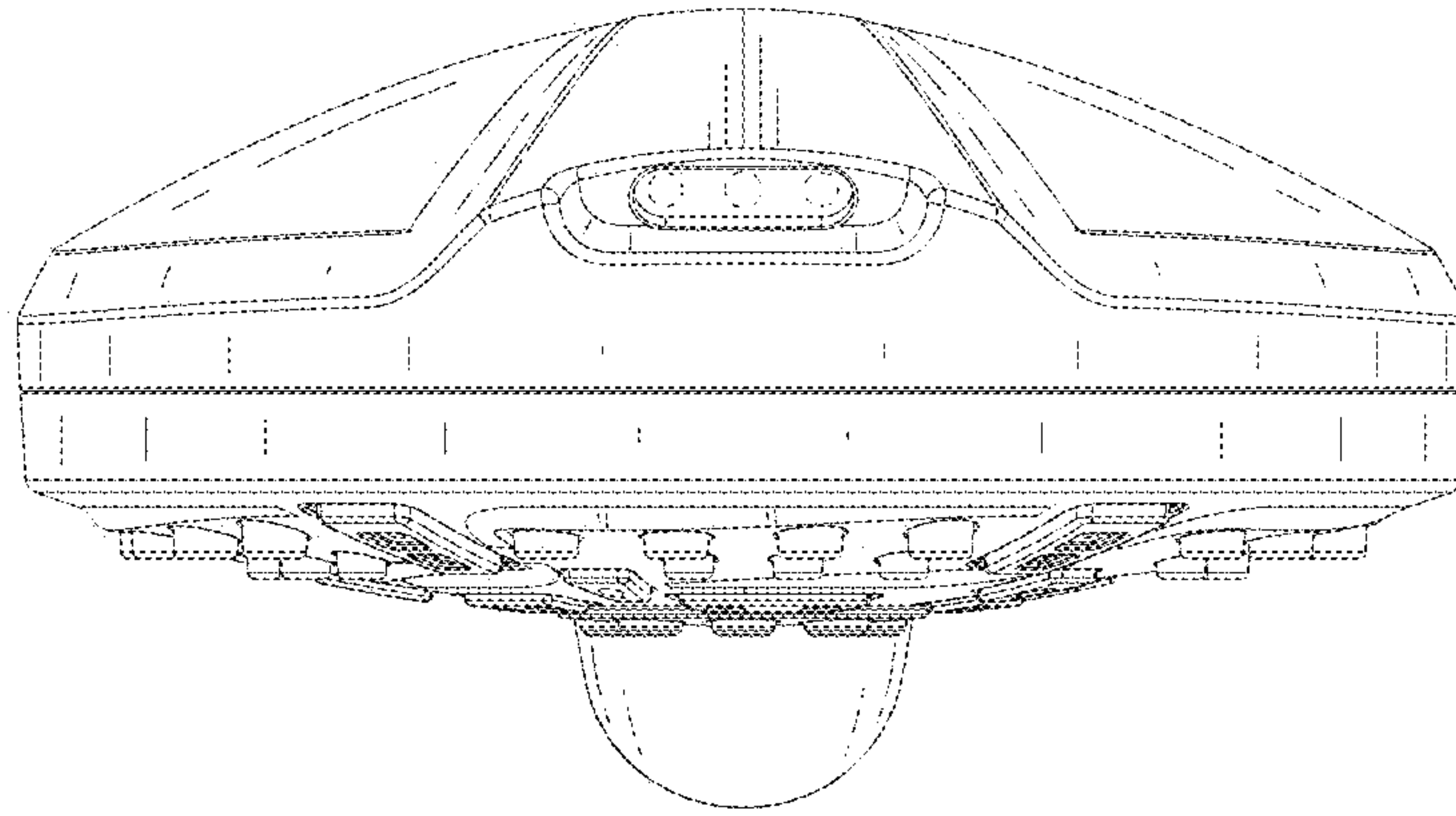

FIG. 7

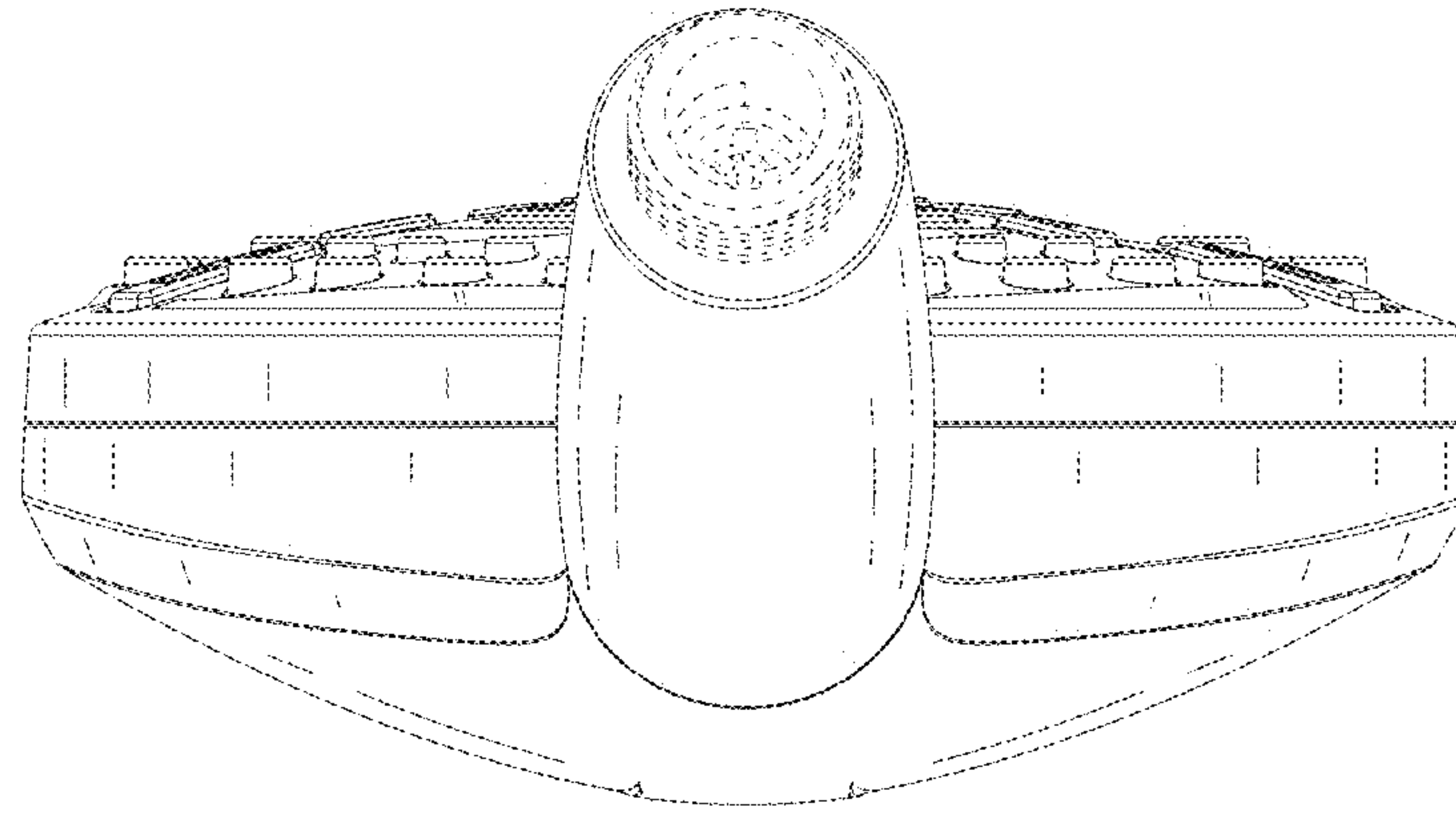

FIG. 8

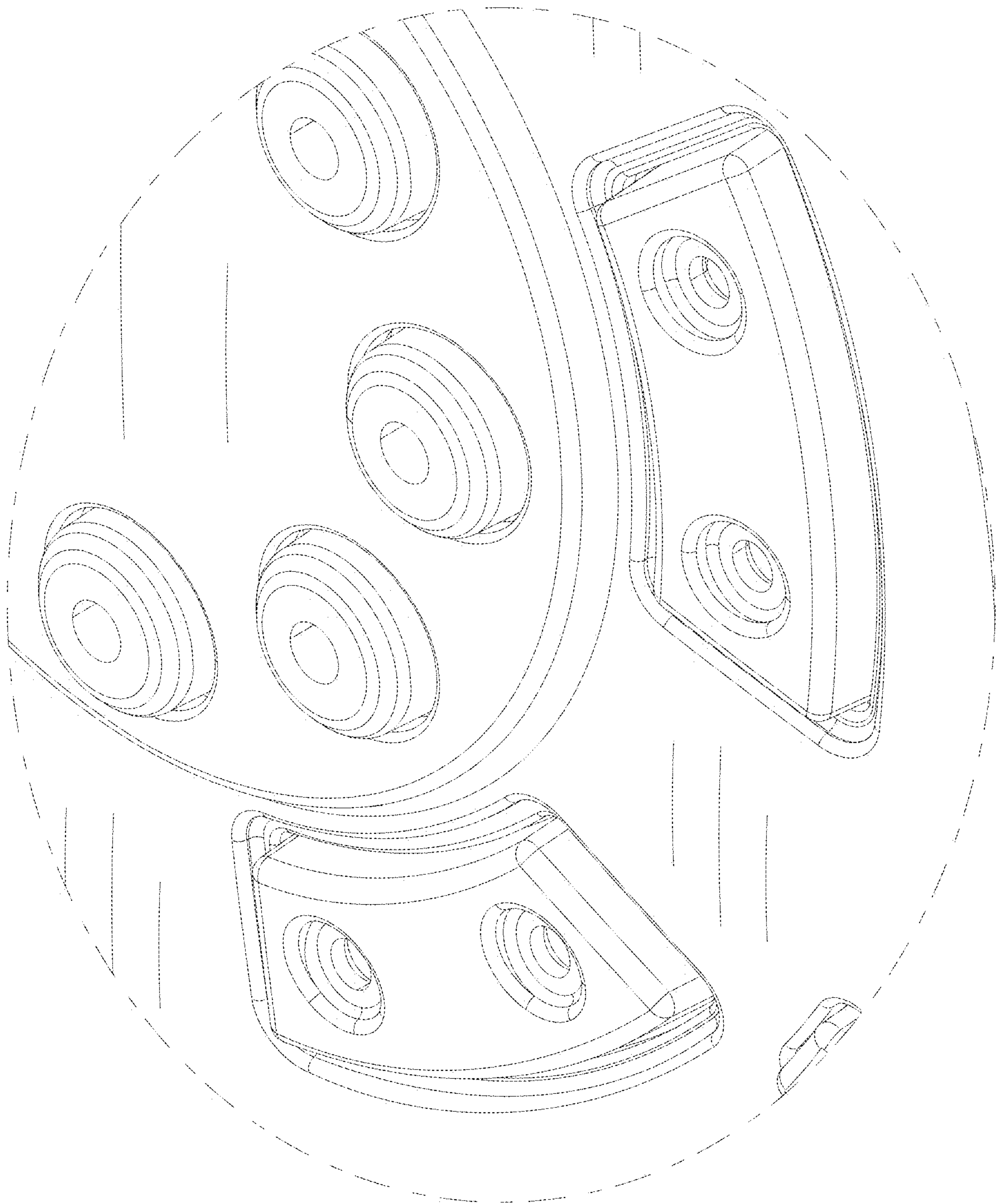

FIG. 9

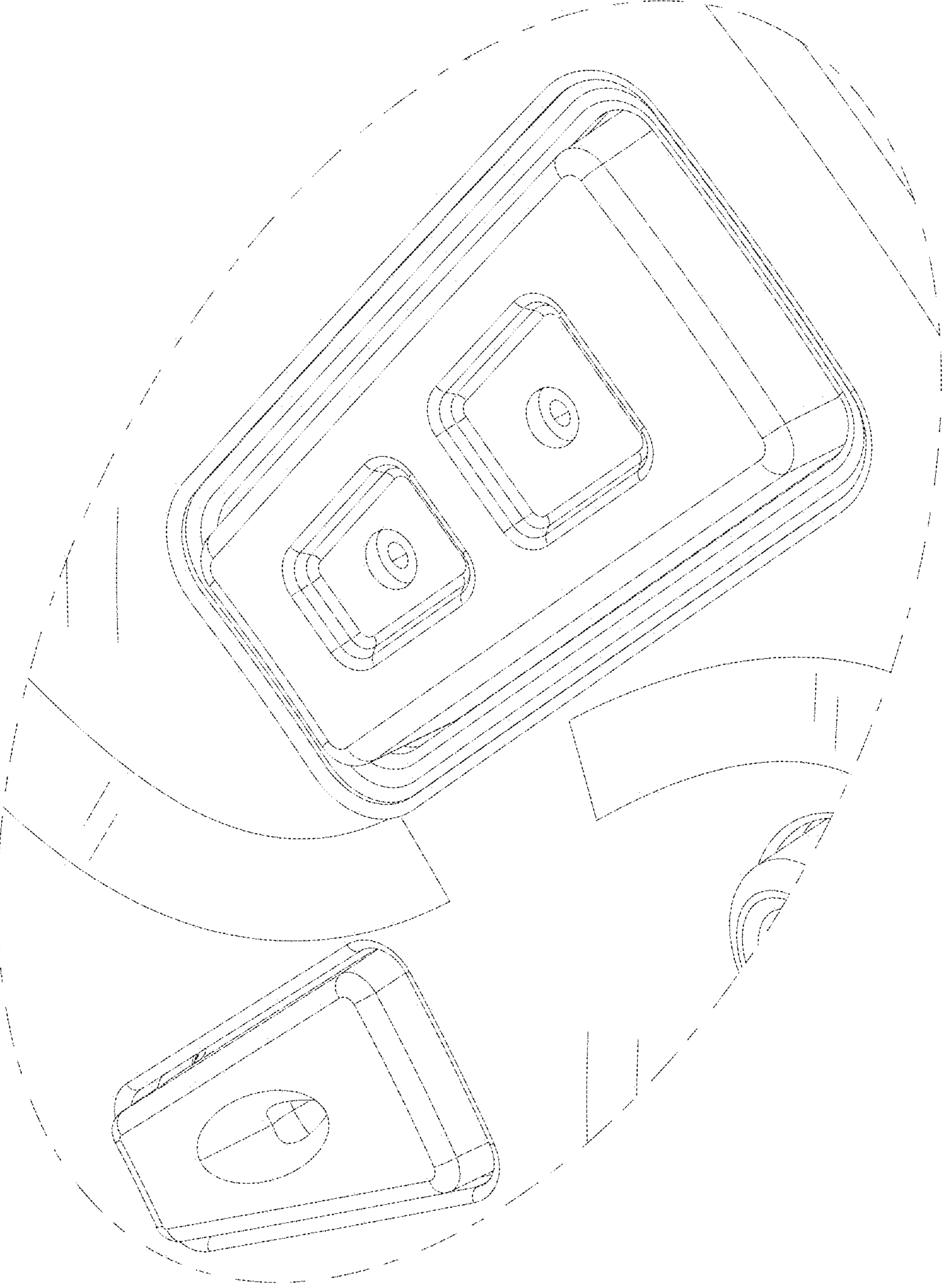

FIG. 10