



US00D982554S

(12) **United States Design Patent** (10) **Patent No.:** **US D982,554 S**
Essabar et al. (45) **Date of Patent:** **** Apr. 4, 2023**

(54) **SPEAKER**

(57) **CLAIM**

(71) Applicant: **EPOS Group A/S**, Ballerup (DK)

The ornamental design for a speaker, as shown and described.

(72) Inventors: **Mohamad Essabar**, Ballerup (DK);
Felix Binder, Berlin (DE)

(73) Assignee: **EPOS GROUP A/S**, Ballerup (DK)

DESCRIPTION

(**) Term: **15 Years**

(21) Appl. No.: **29/774,006**

(22) Filed: **Mar. 12, 2021**

(30) **Foreign Application Priority Data**

Sep. 15, 2020 (EM) 008170039-0001
Sep. 15, 2020 (EM) 008170039-0002

(51) **LOC (14) Cl.** **14-01**

(52) **U.S. Cl.**
USPC **D14/216**

(58) **Field of Classification Search**
USPC D7/629; D9/414, 420, 451, 454, 504,
D9/738; D10/15, 40, 22, 104.1, 106.1;
D13/168; D14/171, 888, 204, 211, 214,
D14/215, 358, 496, 509; D23/390, 411
CPC . H02J 7/0042; H04R 1/00; H04R 1/02; G06F
1/1688; G10K 9/22
See application file for complete search history.

(56) **References Cited**

U.S. PATENT DOCUMENTS

D810,045 S * 2/2018 Kim D14/204
D810,970 S * 2/2018 Thompson D26/26
D867,334 S * 11/2019 She D14/216

(Continued)

Primary Examiner — Khawaja Anwar

Assistant Examiner — Megan Tiana Rakos

(74) *Attorney, Agent, or Firm* — Birch, Stewart, Kolasch
& Birch, LLP

FIG. 1 is a top view of the speaker;
FIG. 2 is a bottom view thereof;
FIG. 3 is a front view thereof;
FIG. 4 is a rear view thereof;
FIG. 5 is a right side view thereof;
FIG. 6 is a left side view thereof;
FIG. 7 is a perspective view thereof;
FIG. 8 is a top view thereof;
FIG. 9 is a bottom view thereof;
FIG. 10 is a front view thereof;
FIG. 11 is a rear view thereof;
FIG. 12 is a right side view thereof;
FIG. 13 is a left view thereof;
FIG. 14 is a perspective view thereof;
FIG. 15 is a top view of the speaker according to another embodiment where FIGS. 22-28 are the same design as FIGS. 15-21 however, FIGS. 22-28 are shown with surface shading;
FIG. 16 is a bottom view thereof;
FIG. 17 is a front view thereof;
FIG. 18 is a rear view thereof;
FIG. 19 is a right side view thereof;
FIG. 20 is a left view thereof;
FIG. 21 is a perspective view thereof;
FIG. 22 is a top view thereof;
FIG. 23 is a bottom view thereof;
FIG. 24 is a front view thereof;
FIG. 25 is a rear view thereof;
FIG. 26 is a right side view thereof;
FIG. 27 is a left view thereof; and,
FIG. 28 is a perspective view thereof.
The broken lines in certain drawings signify areas of the speaker upper surface that form no part of the claimed design.

1 Claim, 28 Drawing Sheets

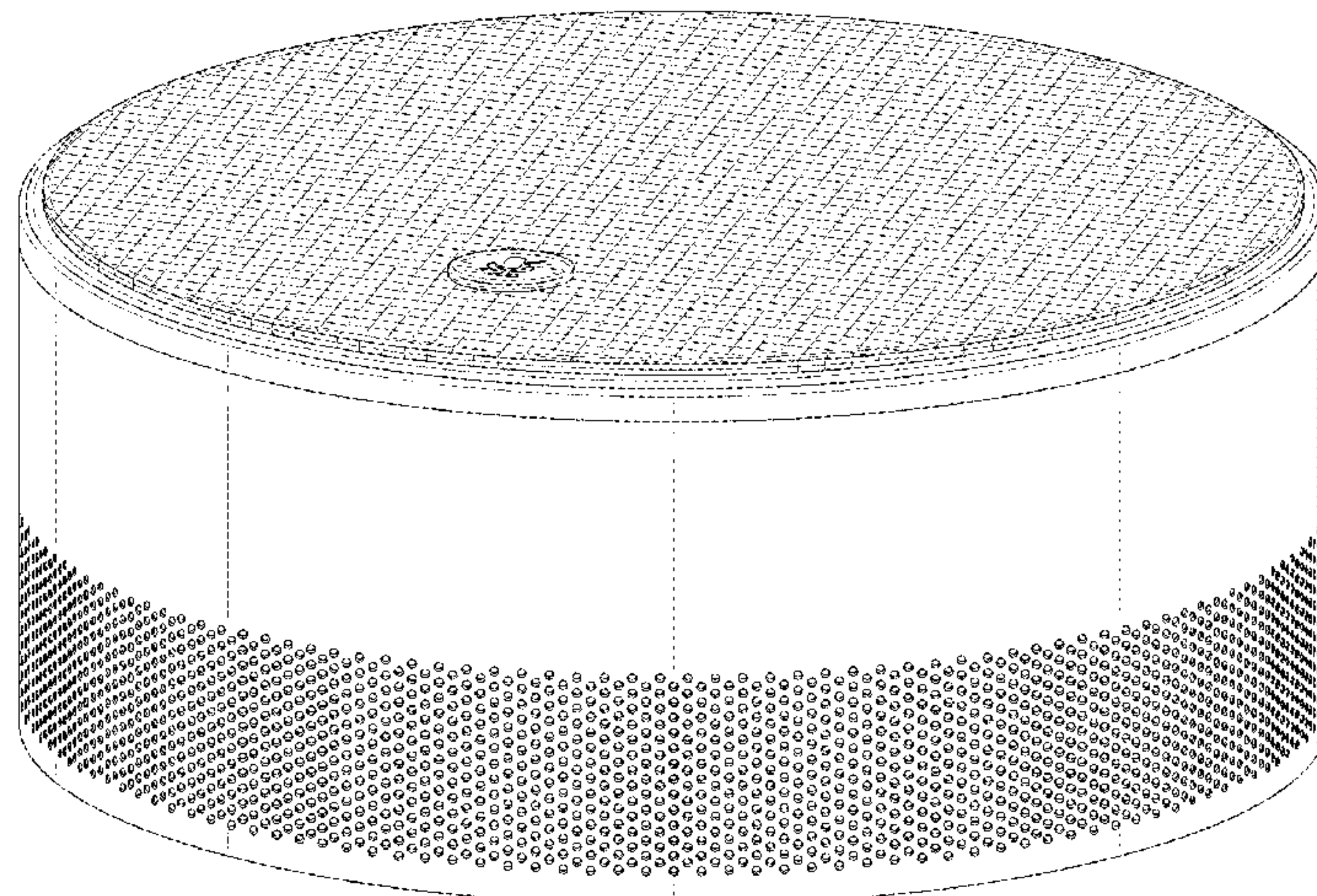

(56)

References Cited

U.S. PATENT DOCUMENTS

D886,079 S * 6/2020 Feng D14/216
D901,412 S * 11/2020 Li D14/126
D947,152 S * 3/2022 Lozinskiy D14/204

* cited by examiner

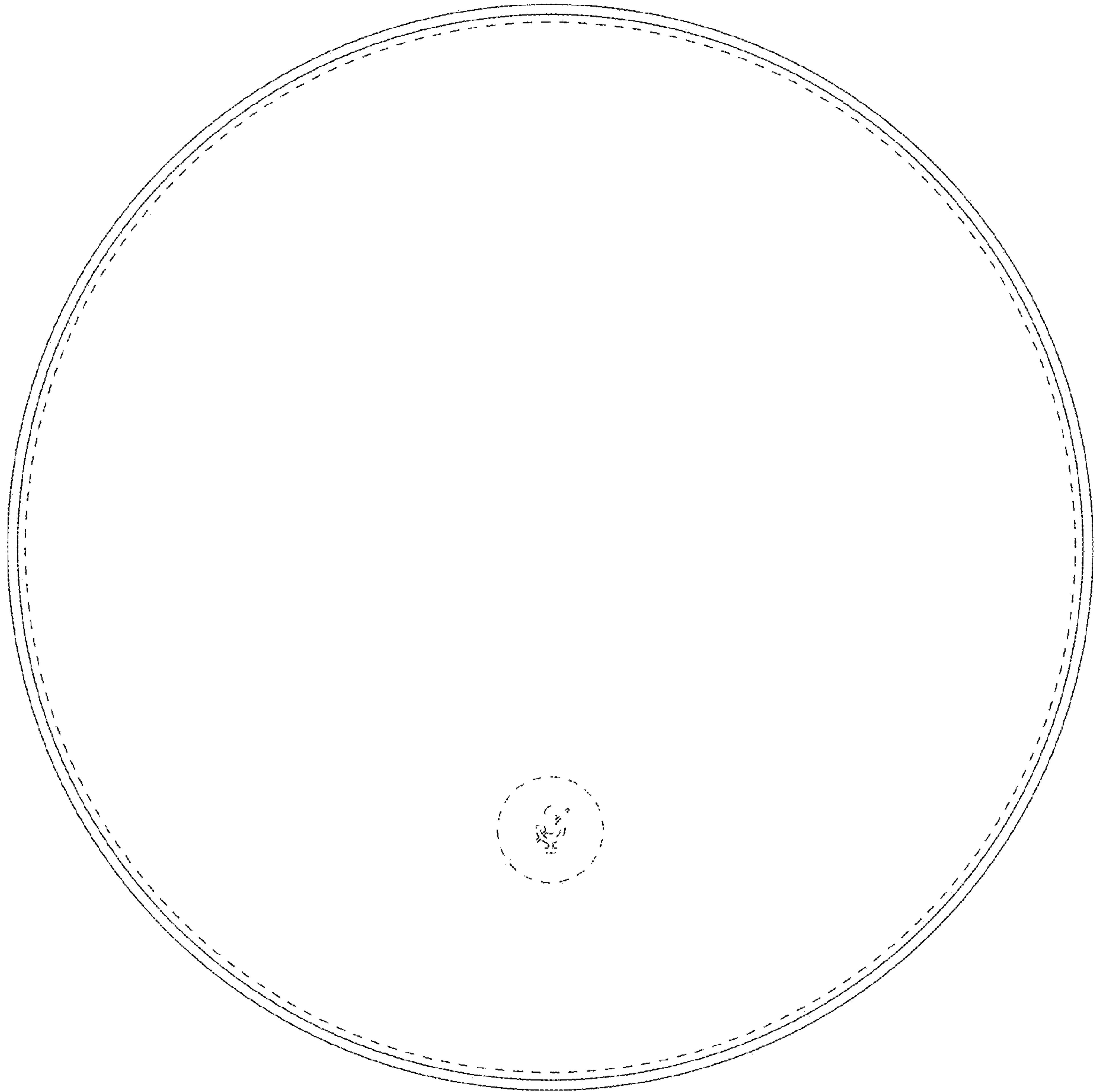

FIG. 1

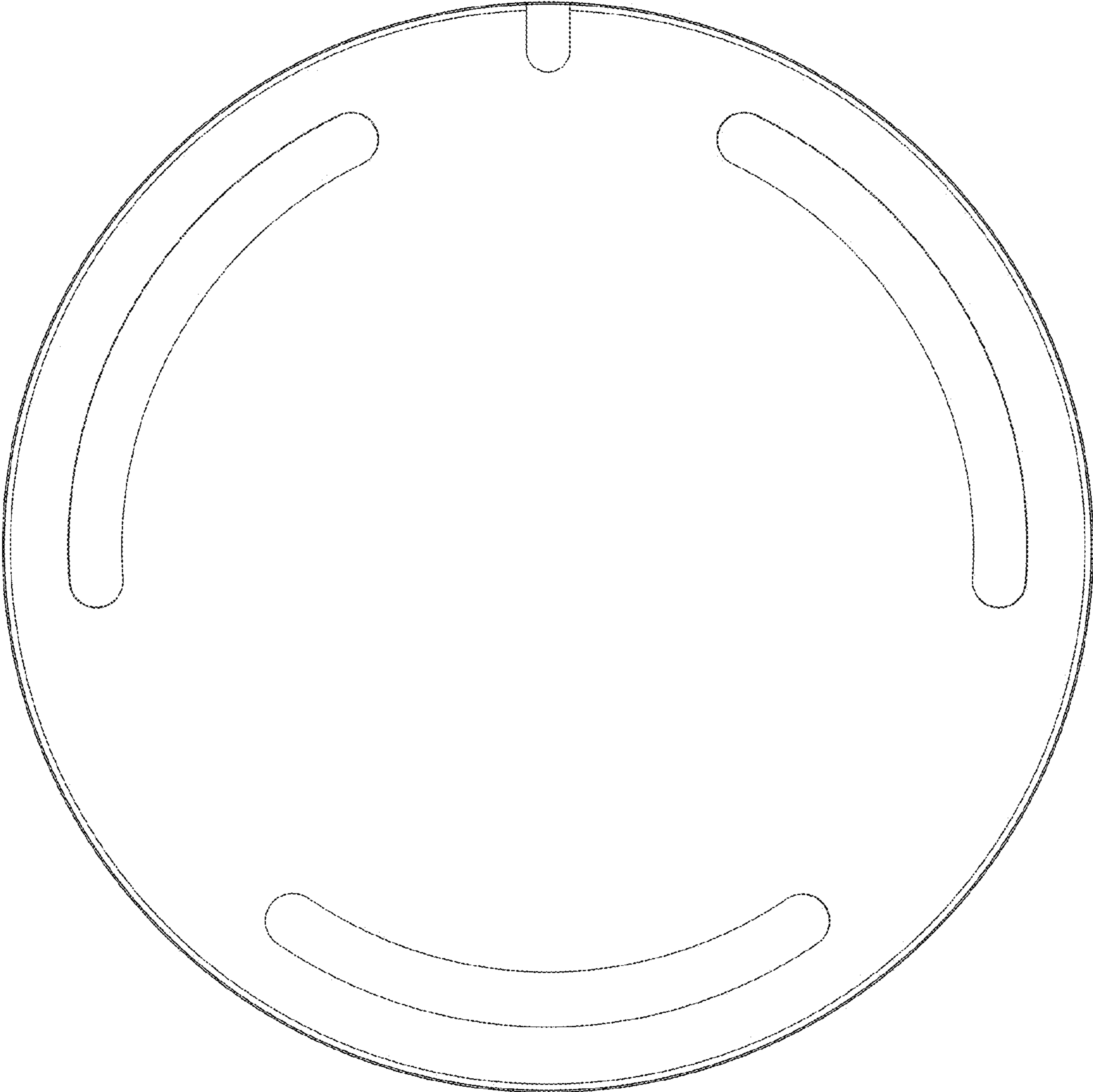

FIG. 2

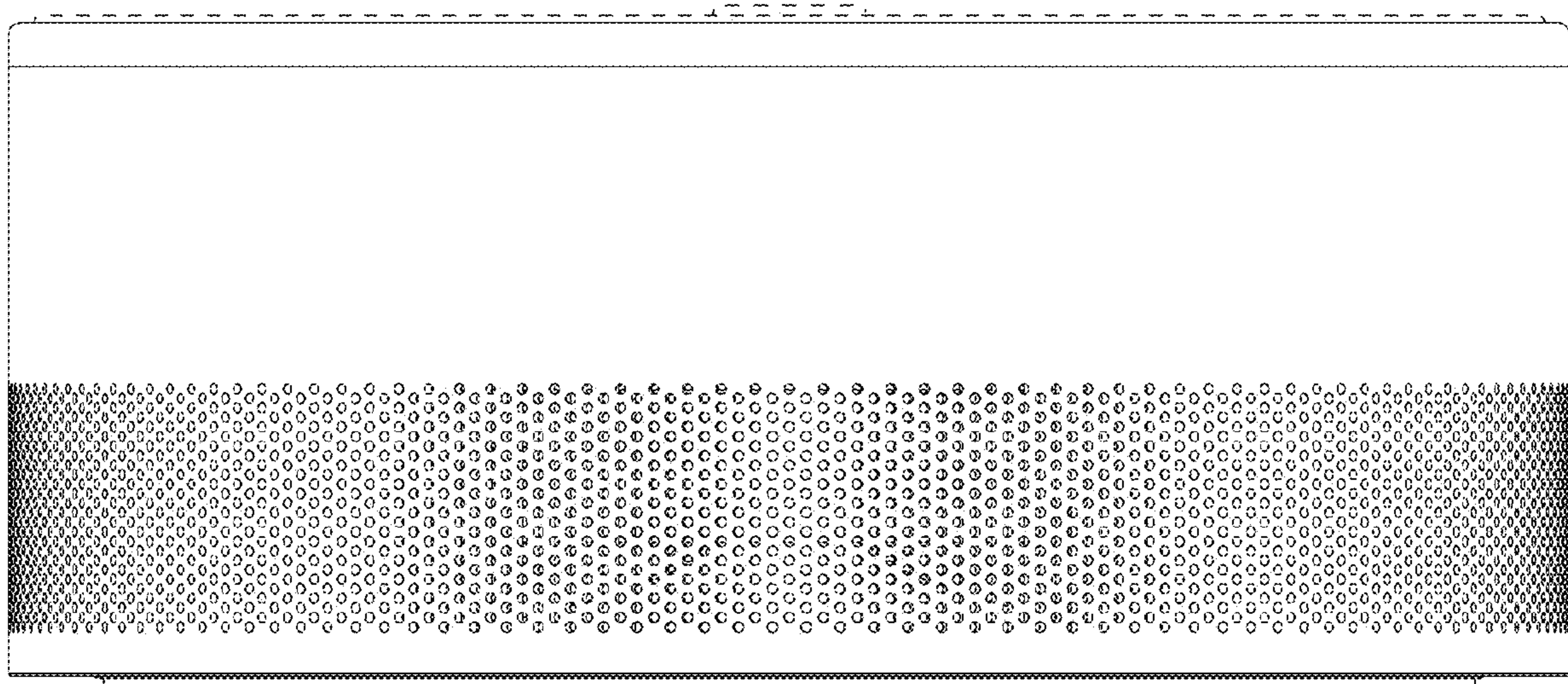

FIG. 3

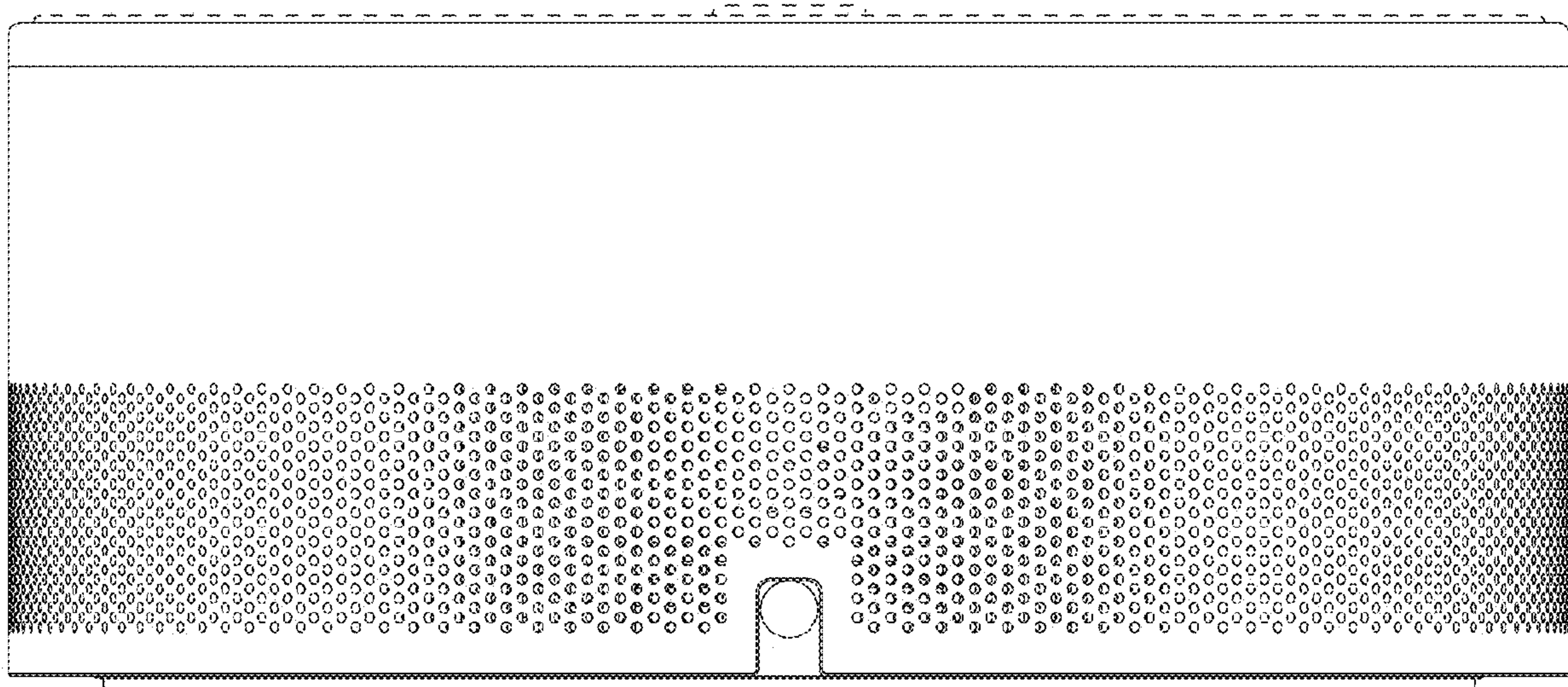

FIG. 4

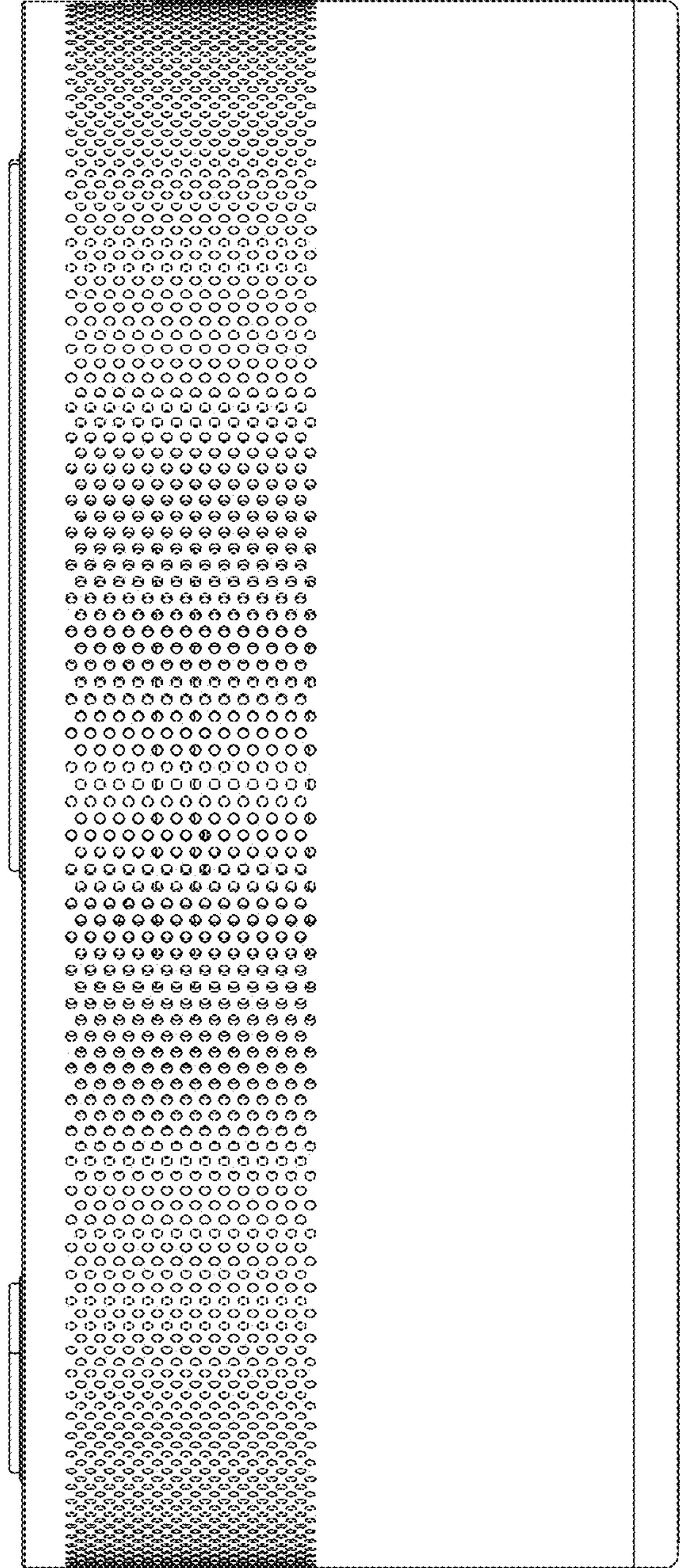

FIG. 5

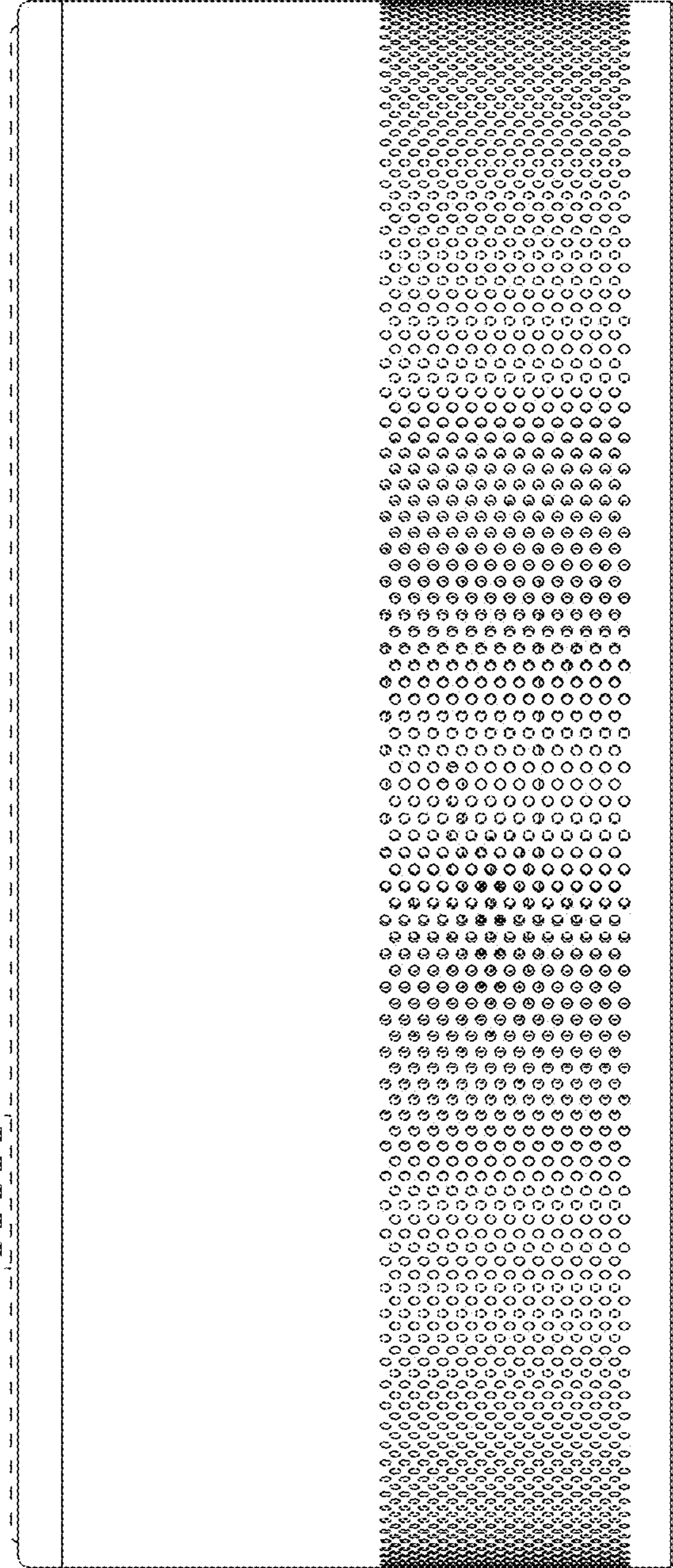

FIG. 6

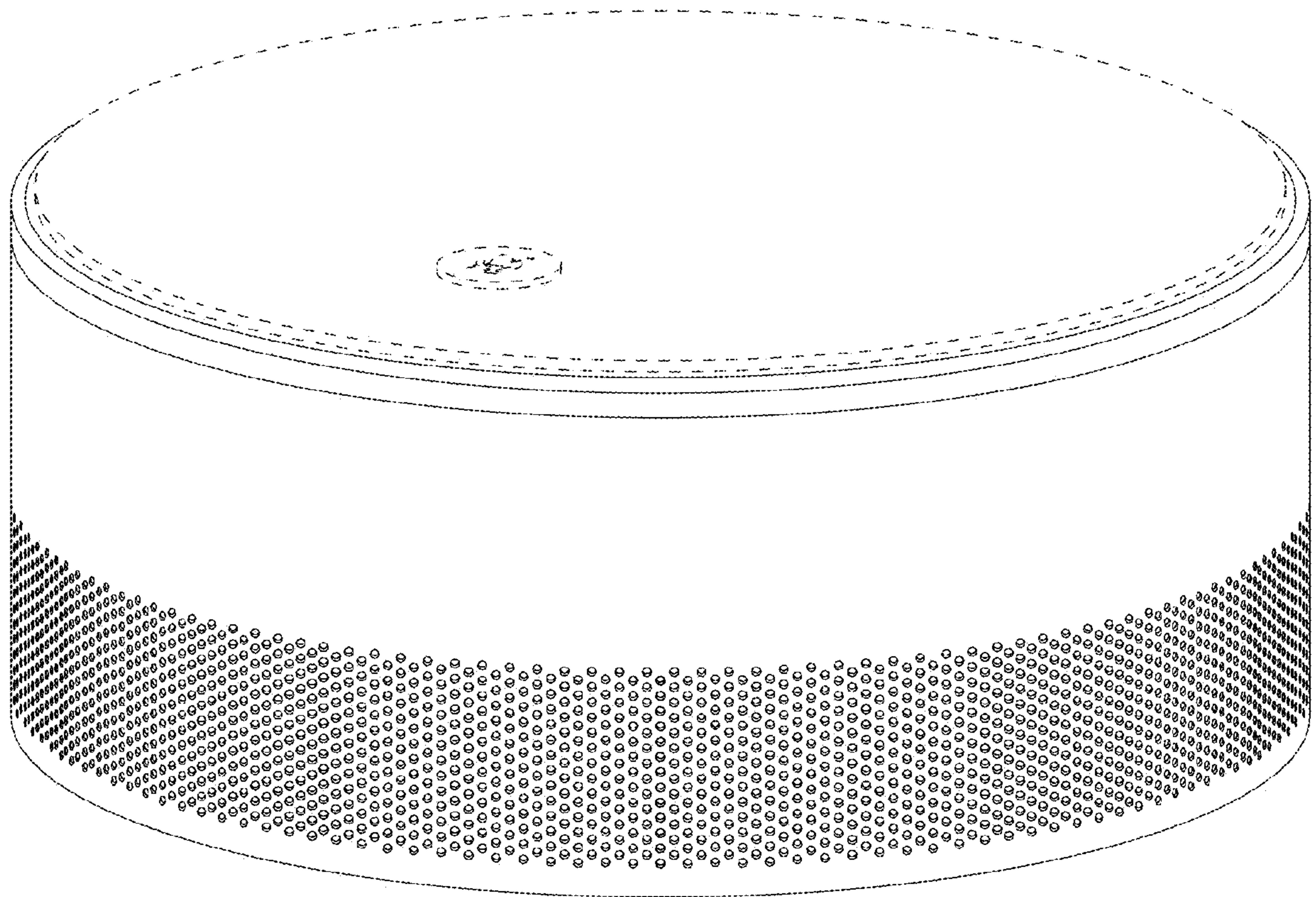

FIG. 7

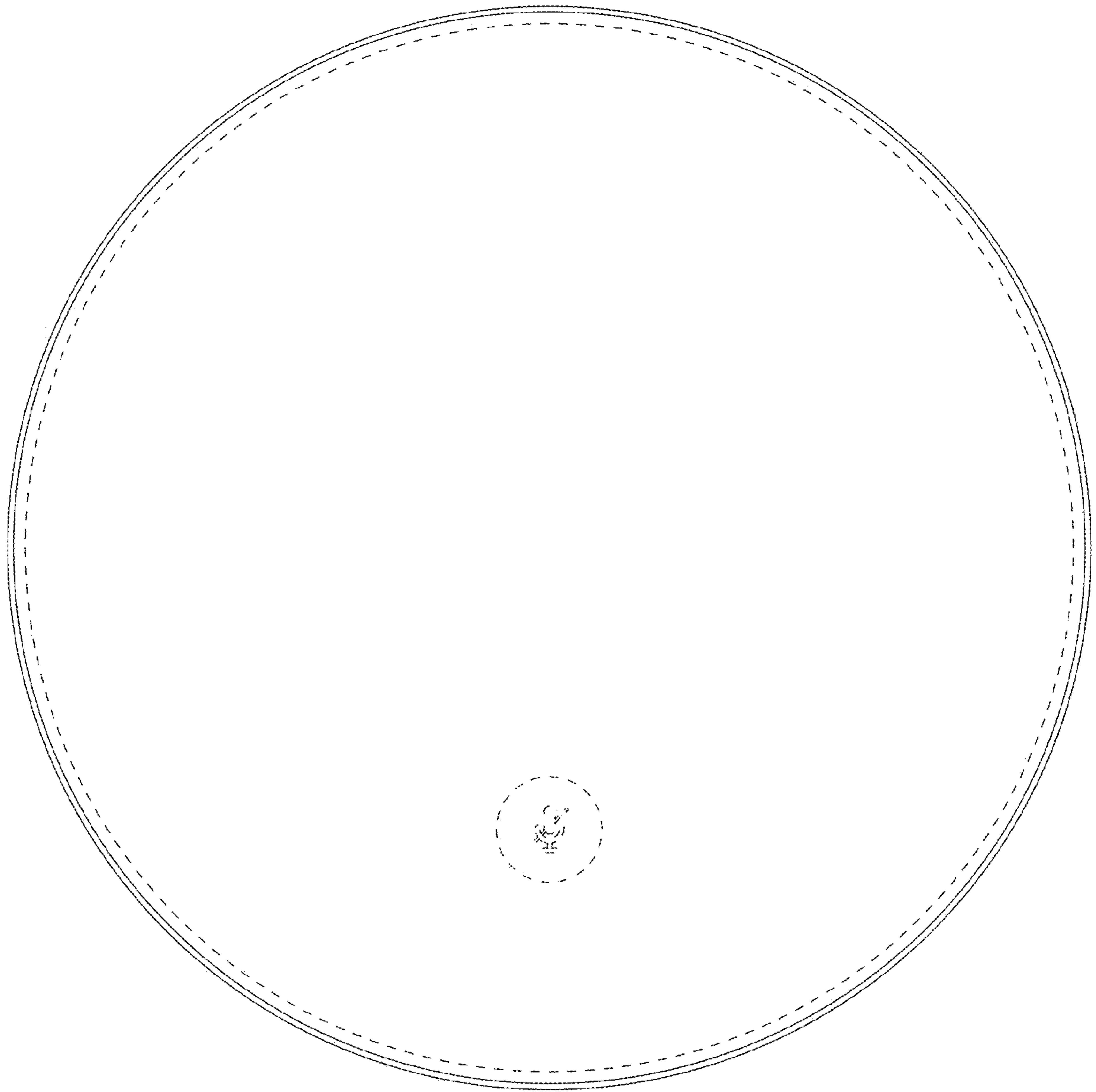

FIG. 8

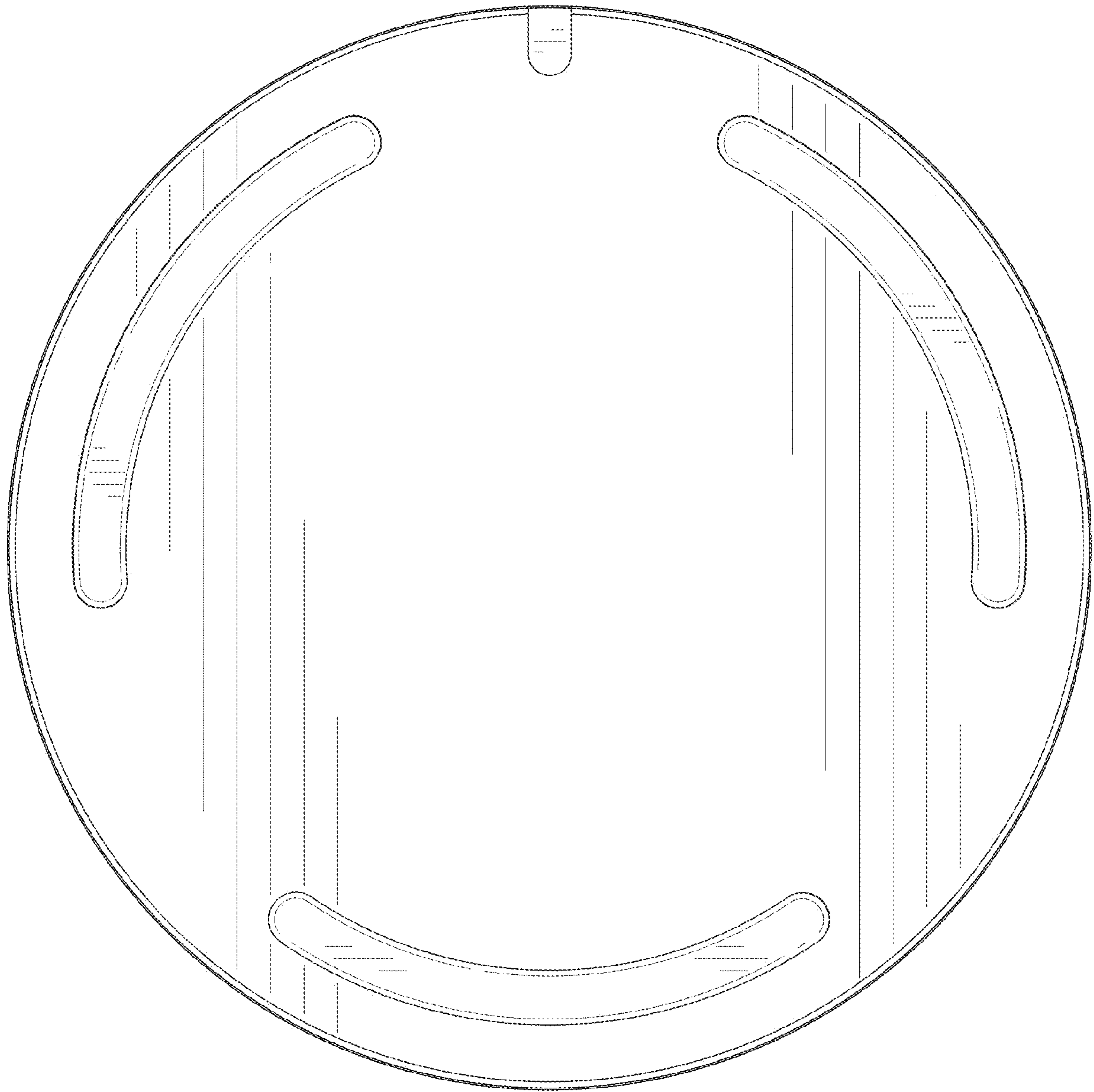

FIG. 9

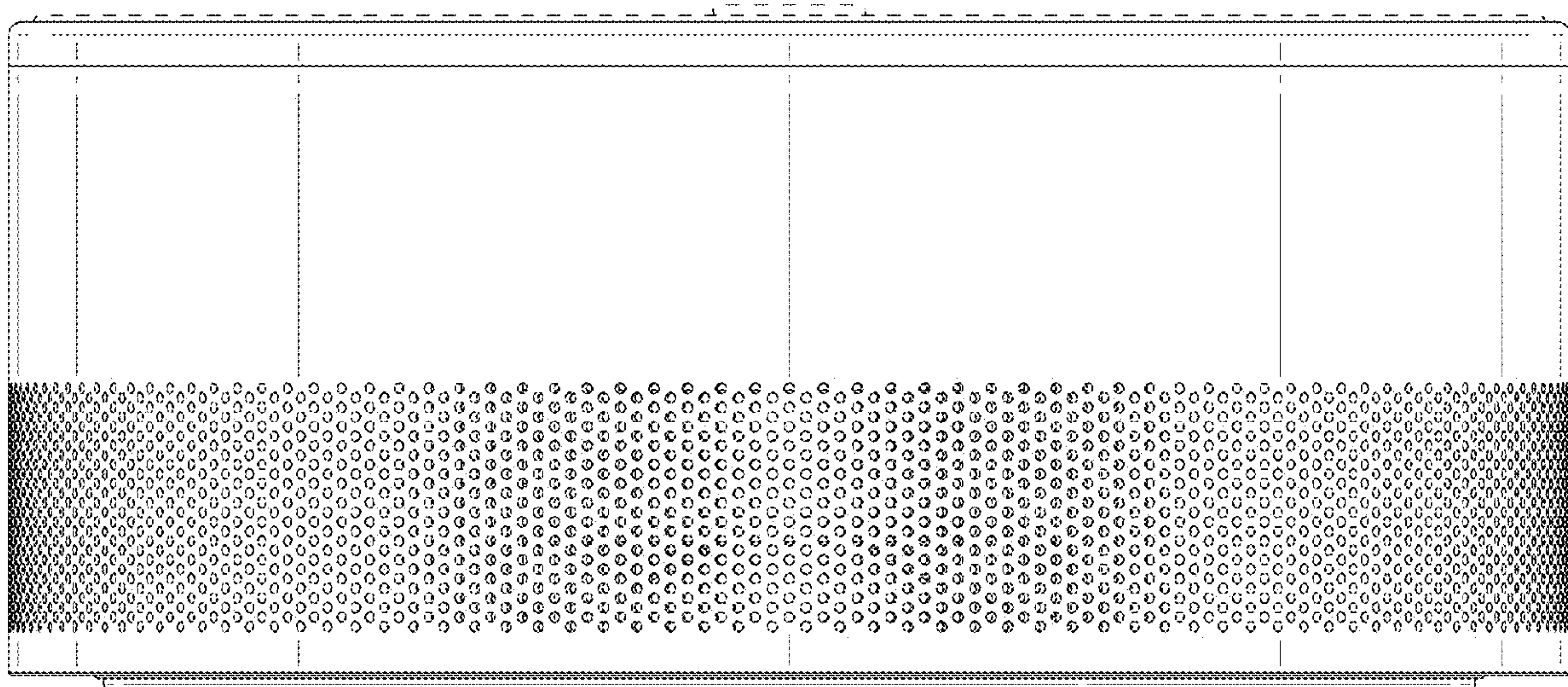

FIG. 10

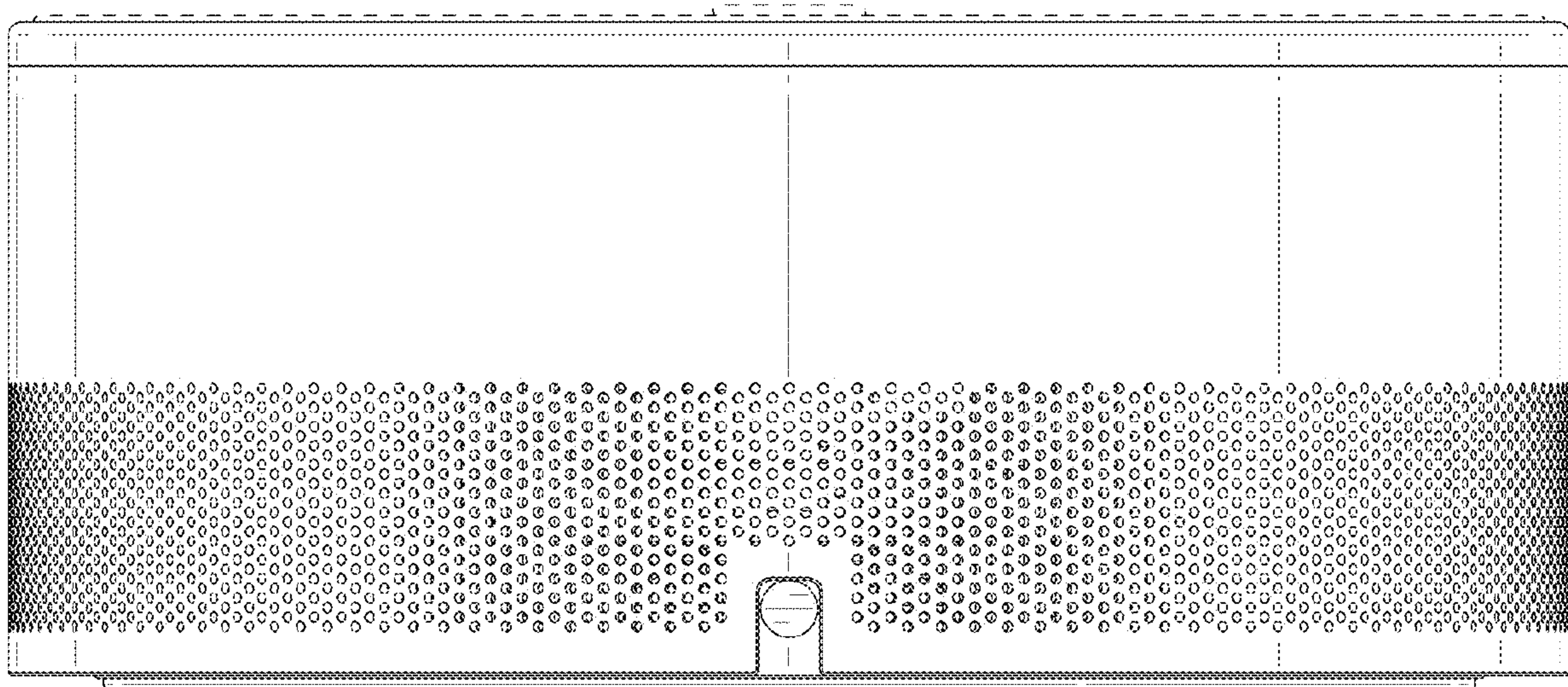

FIG. 11

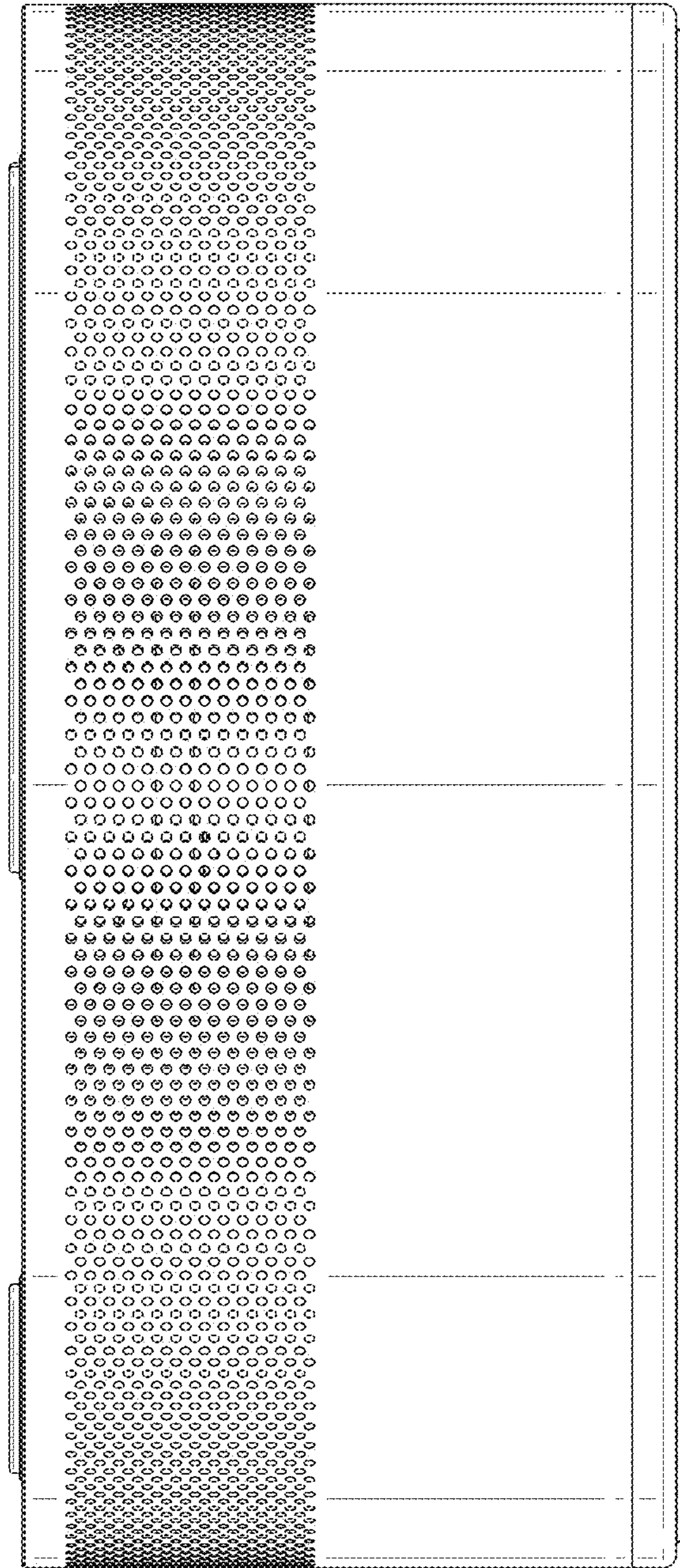

FIG. 12

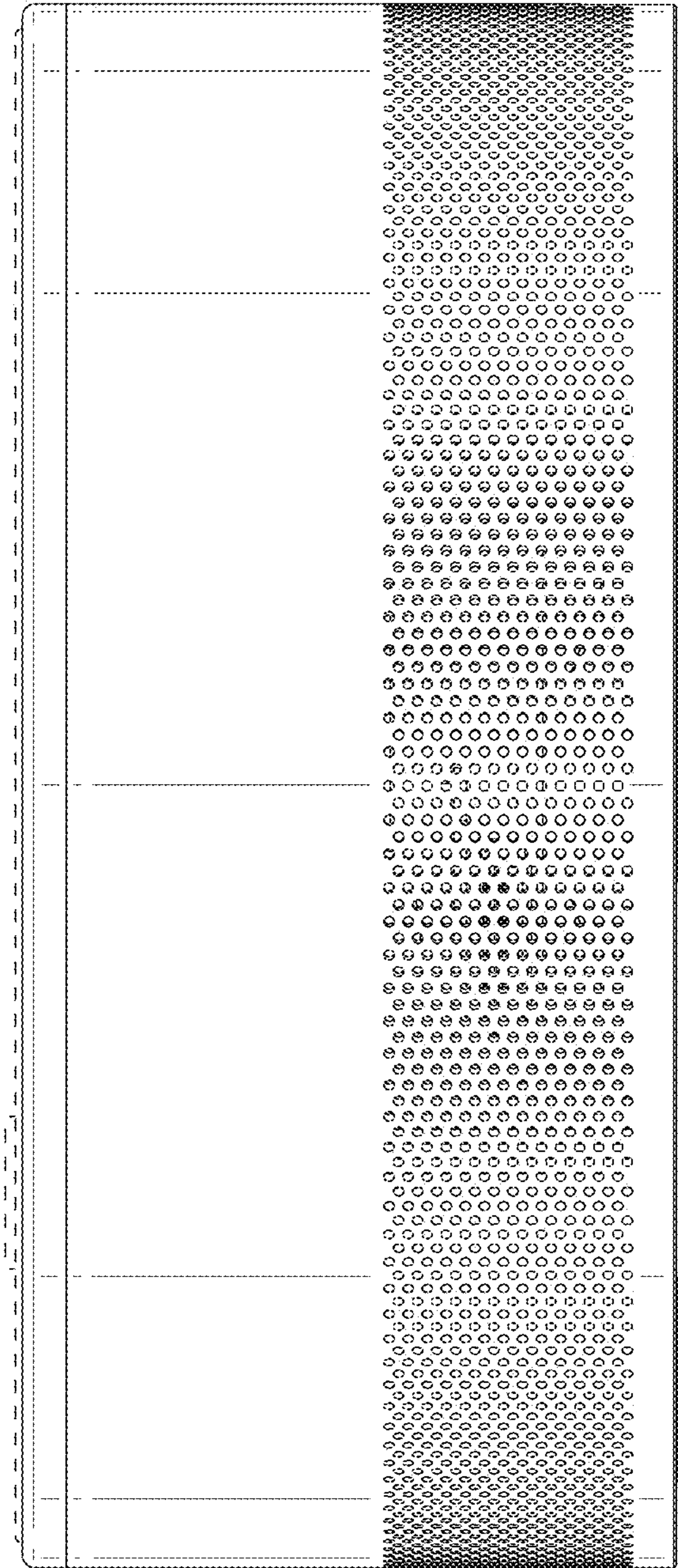

FIG. 13

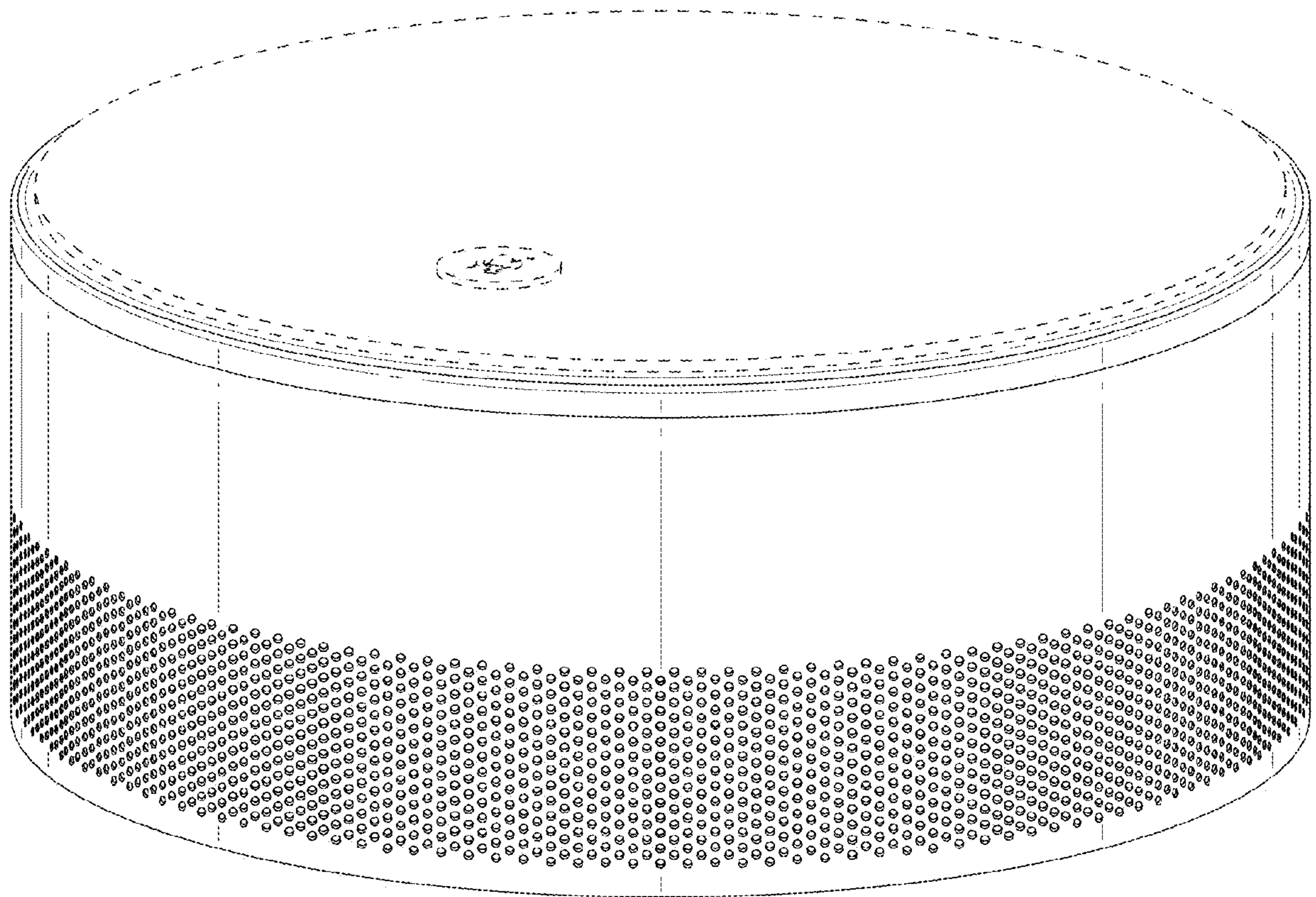

FIG. 14

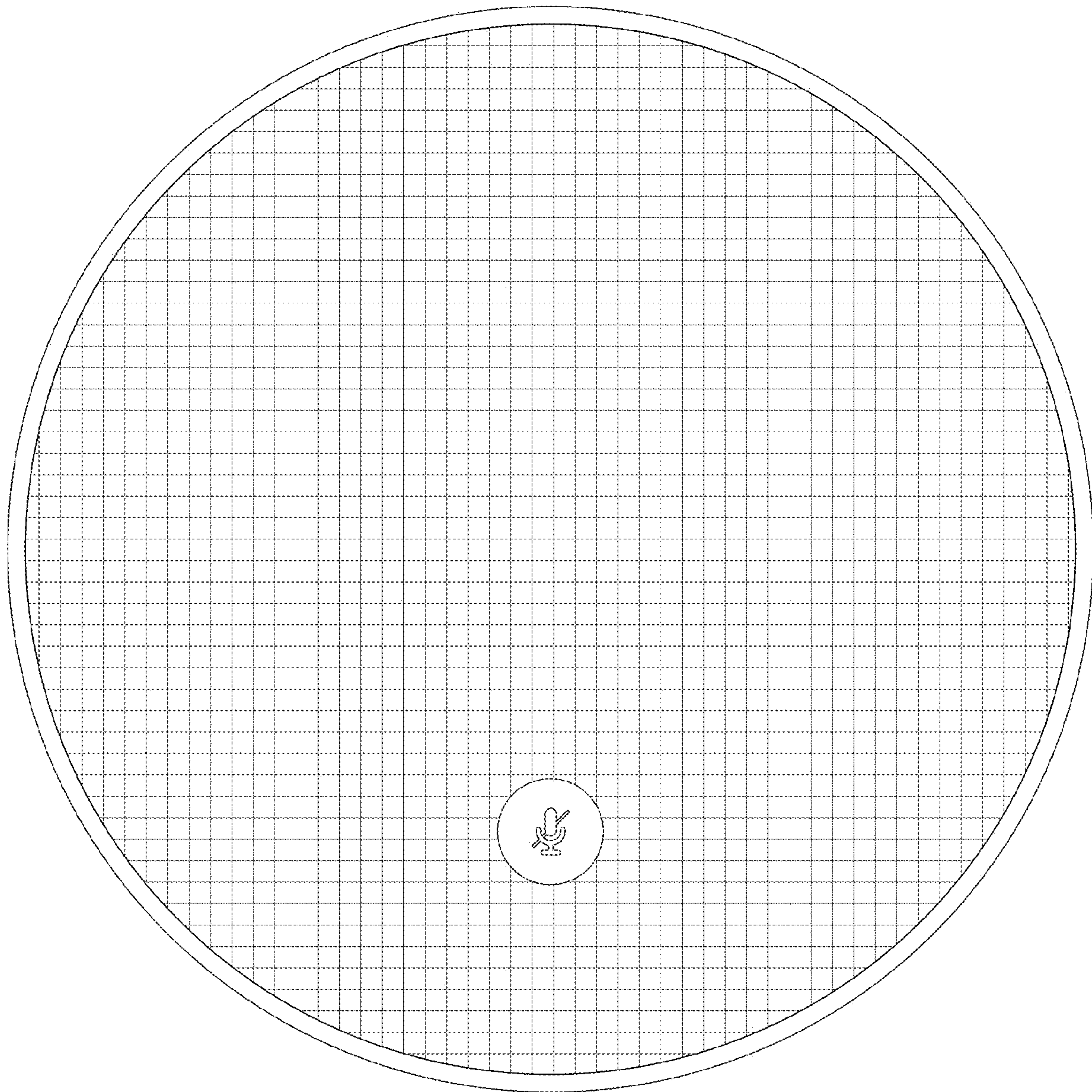

FIG. 15

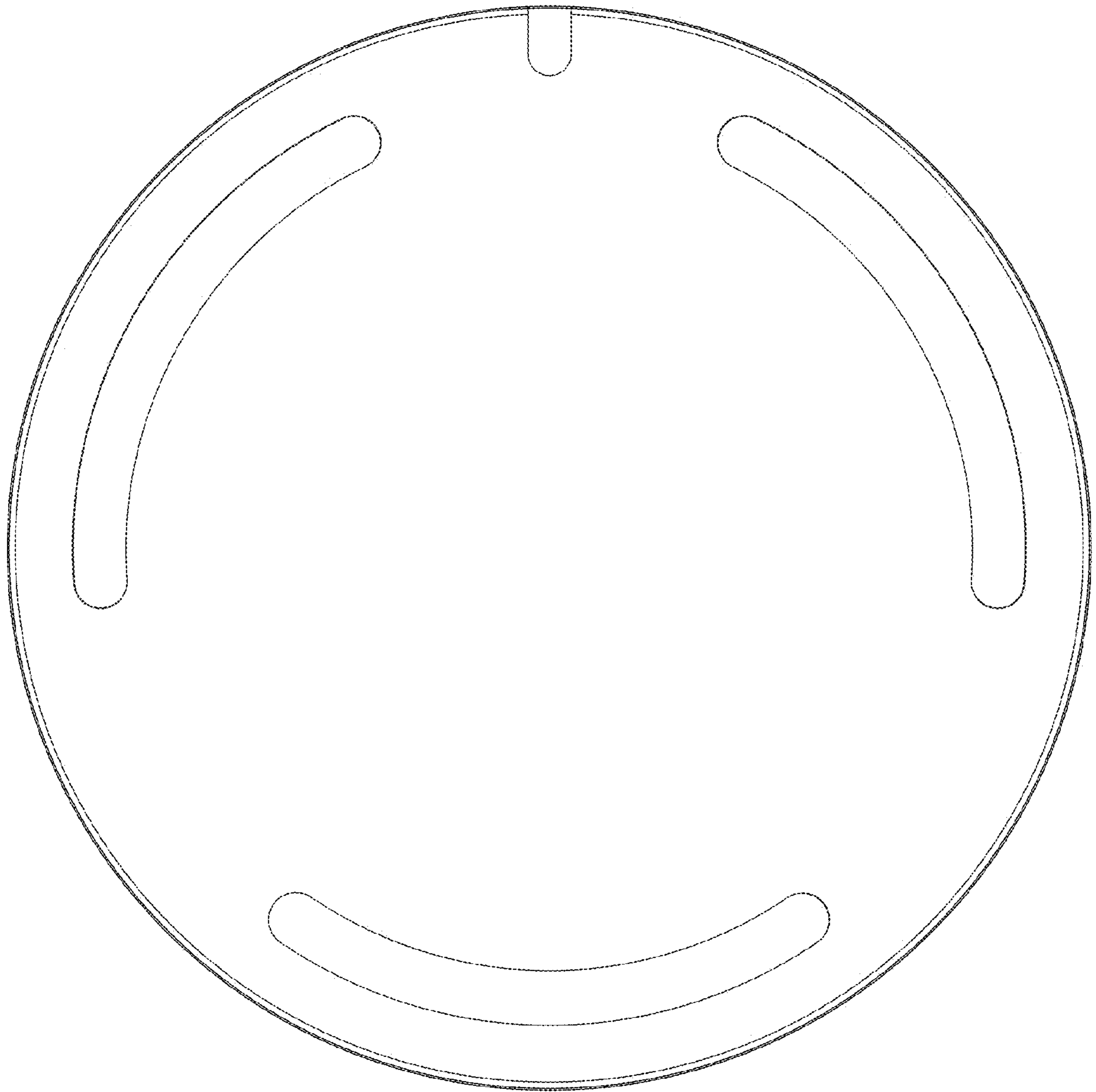

FIG. 16

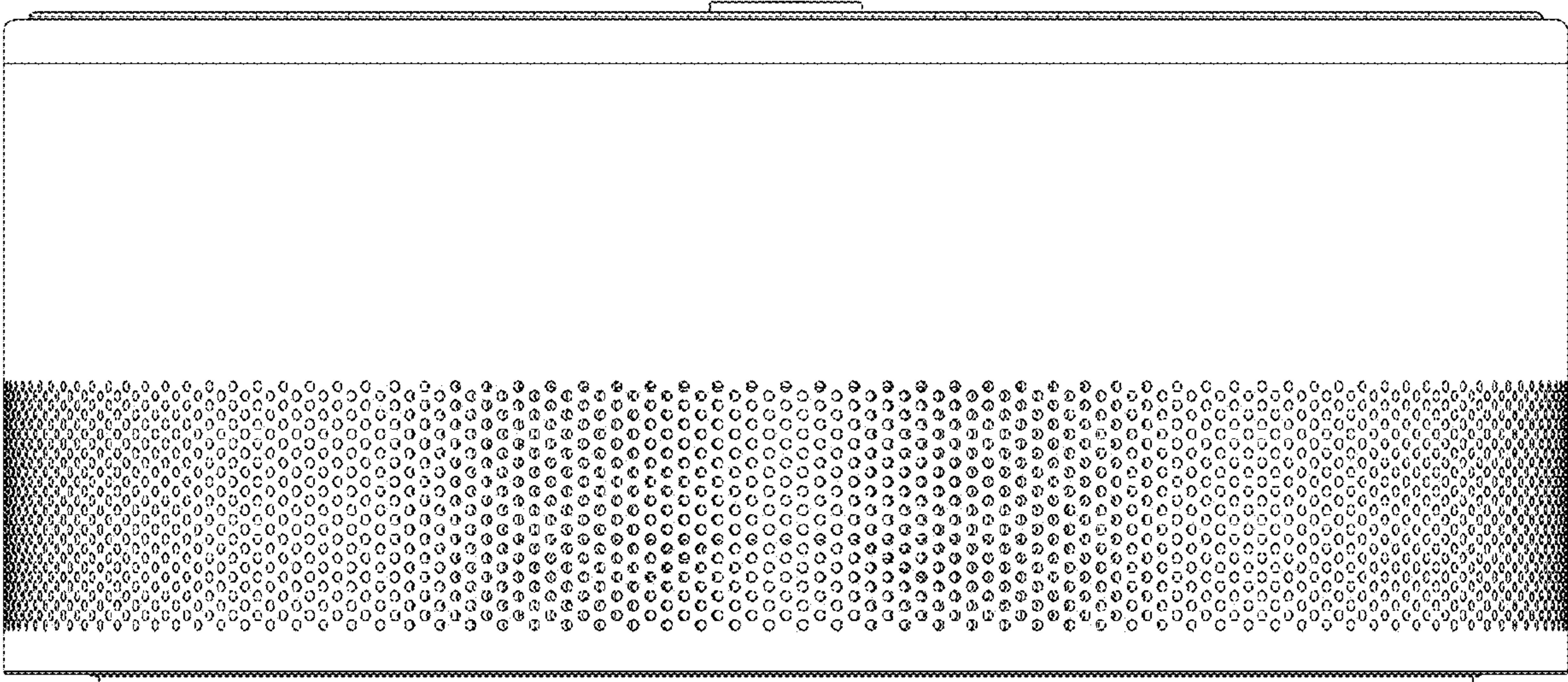

FIG. 17

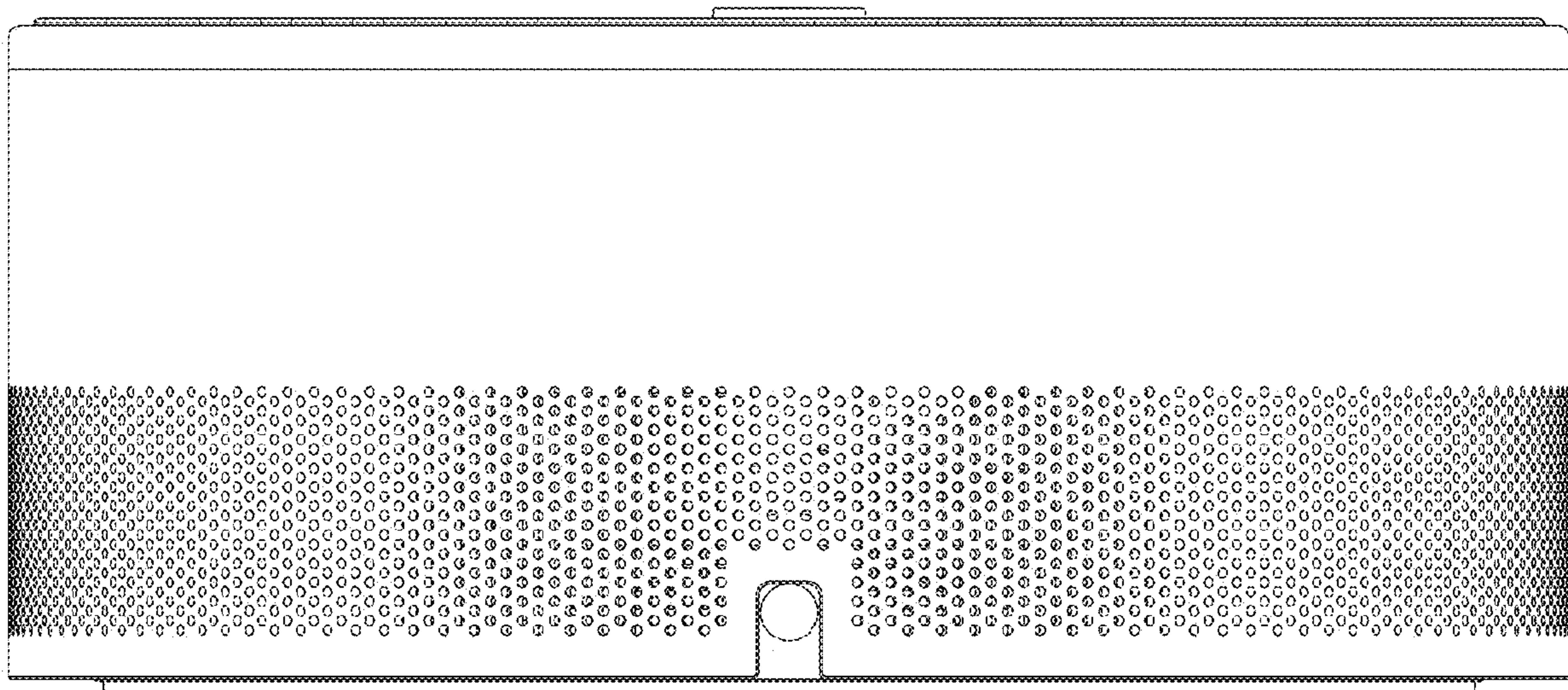

FIG. 18

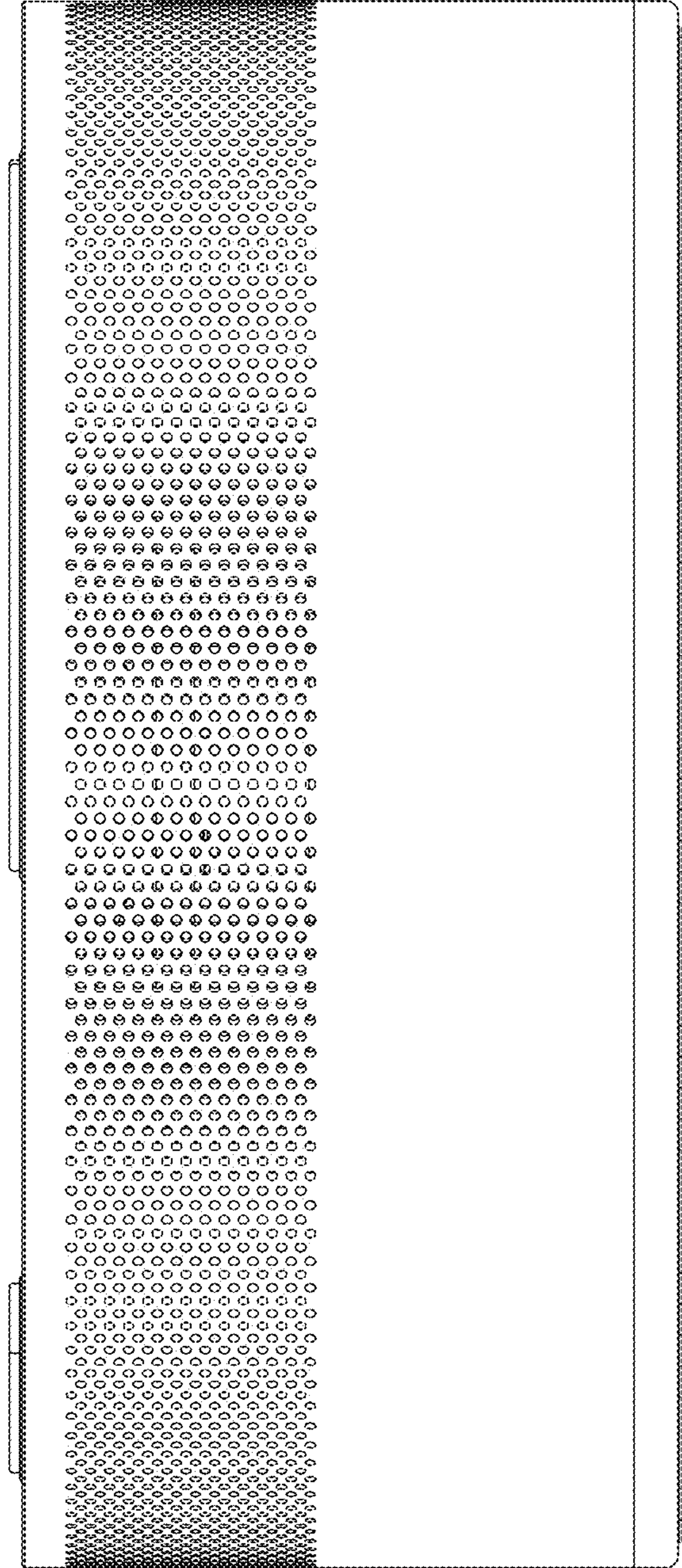

FIG. 19

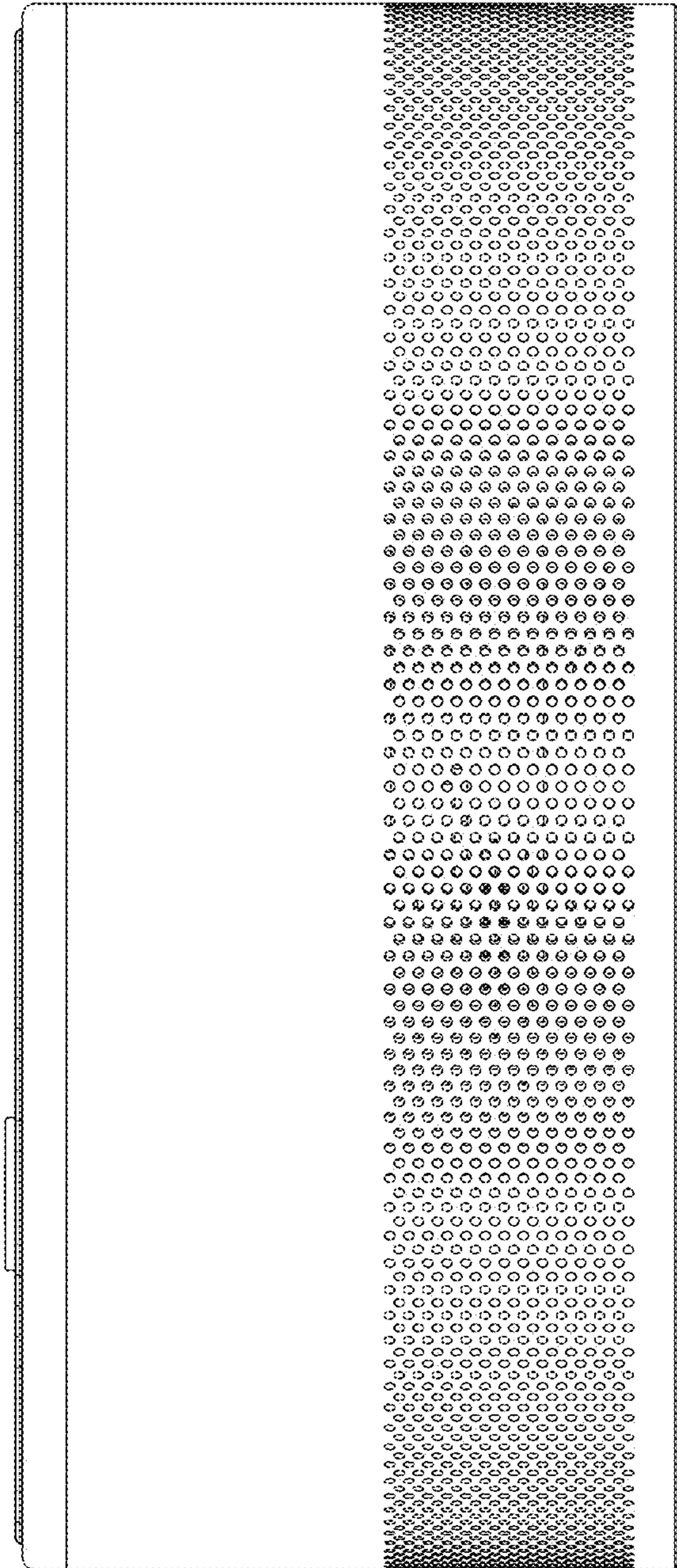

FIG. 20

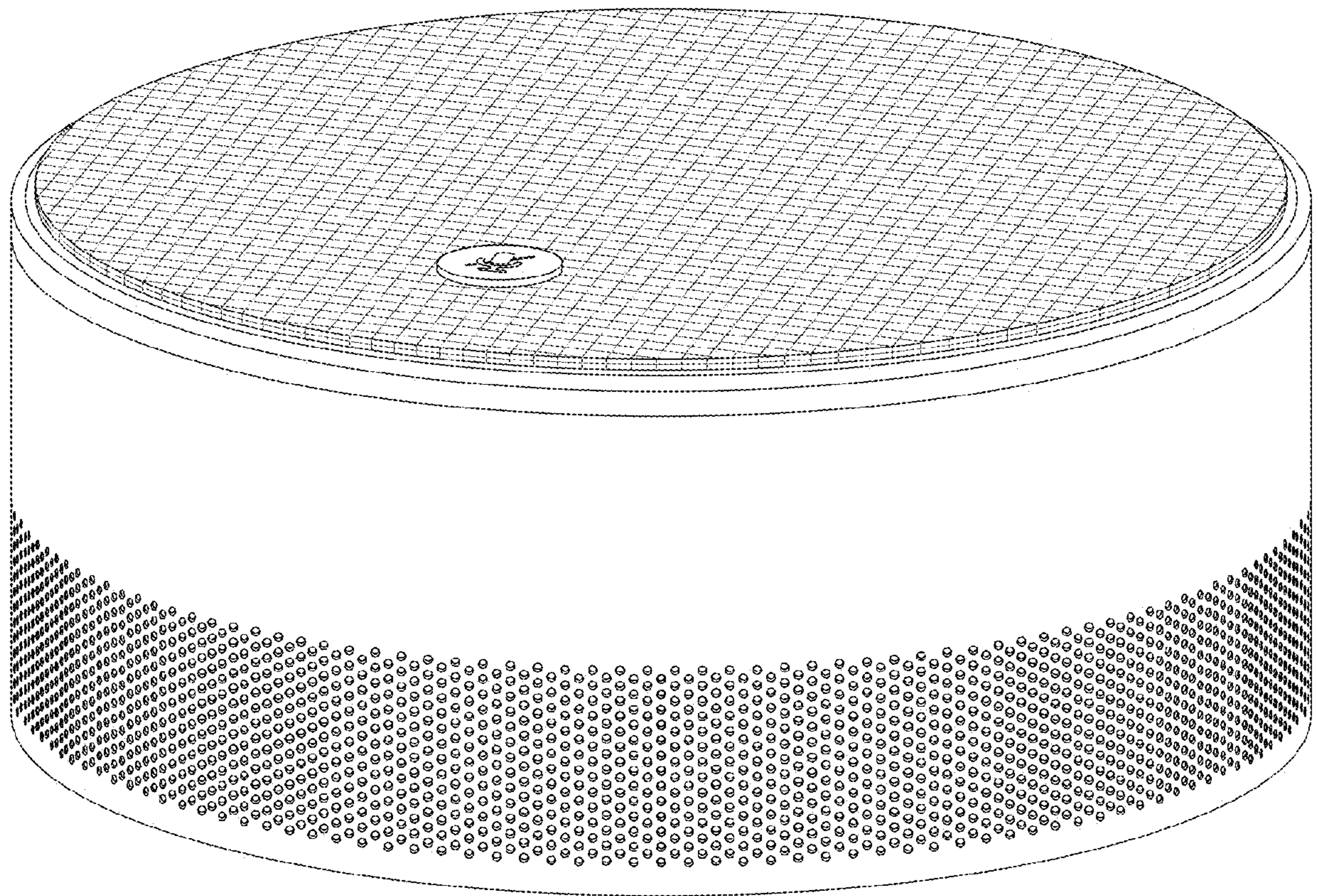

FIG. 21

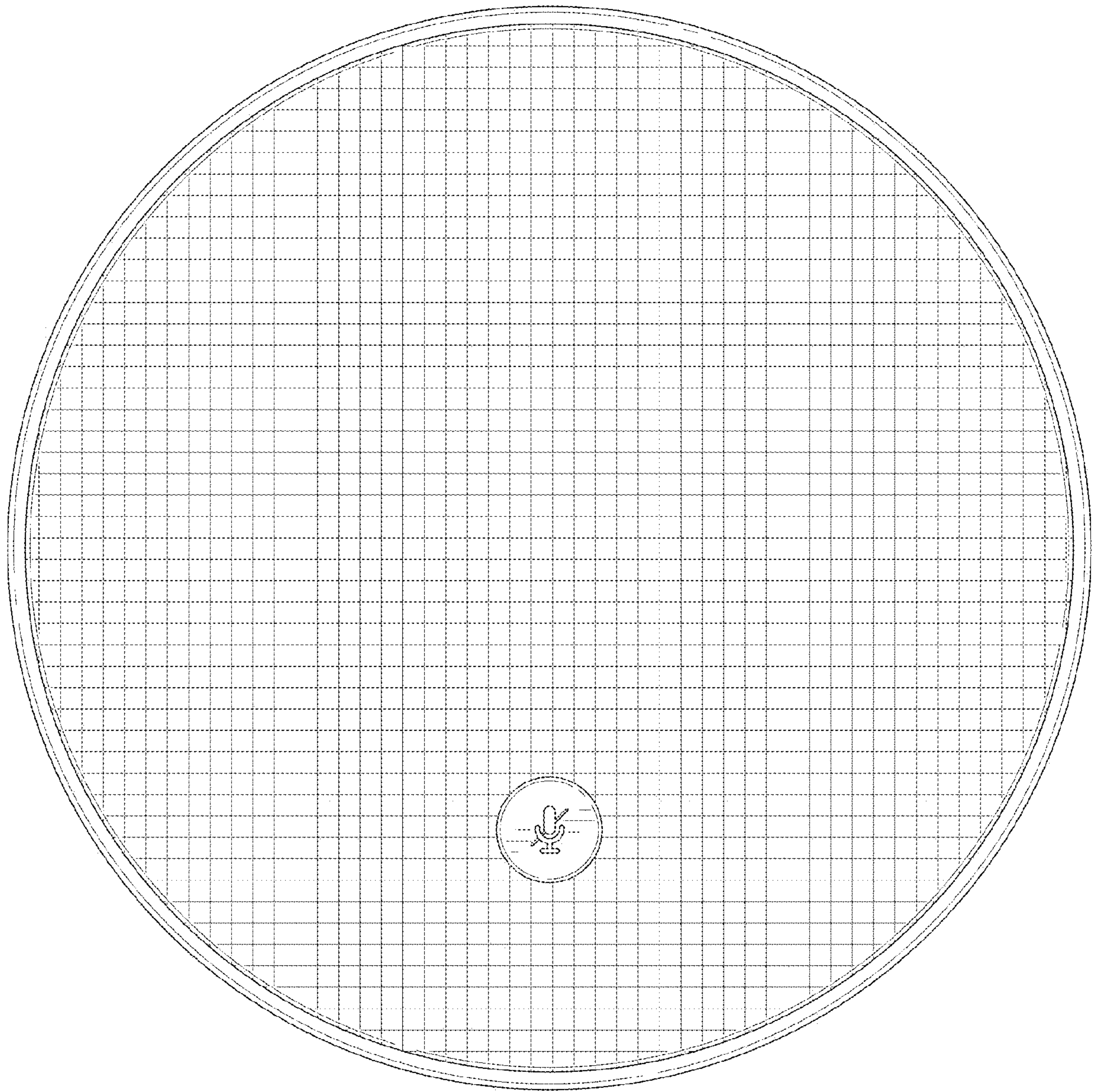

FIG. 22

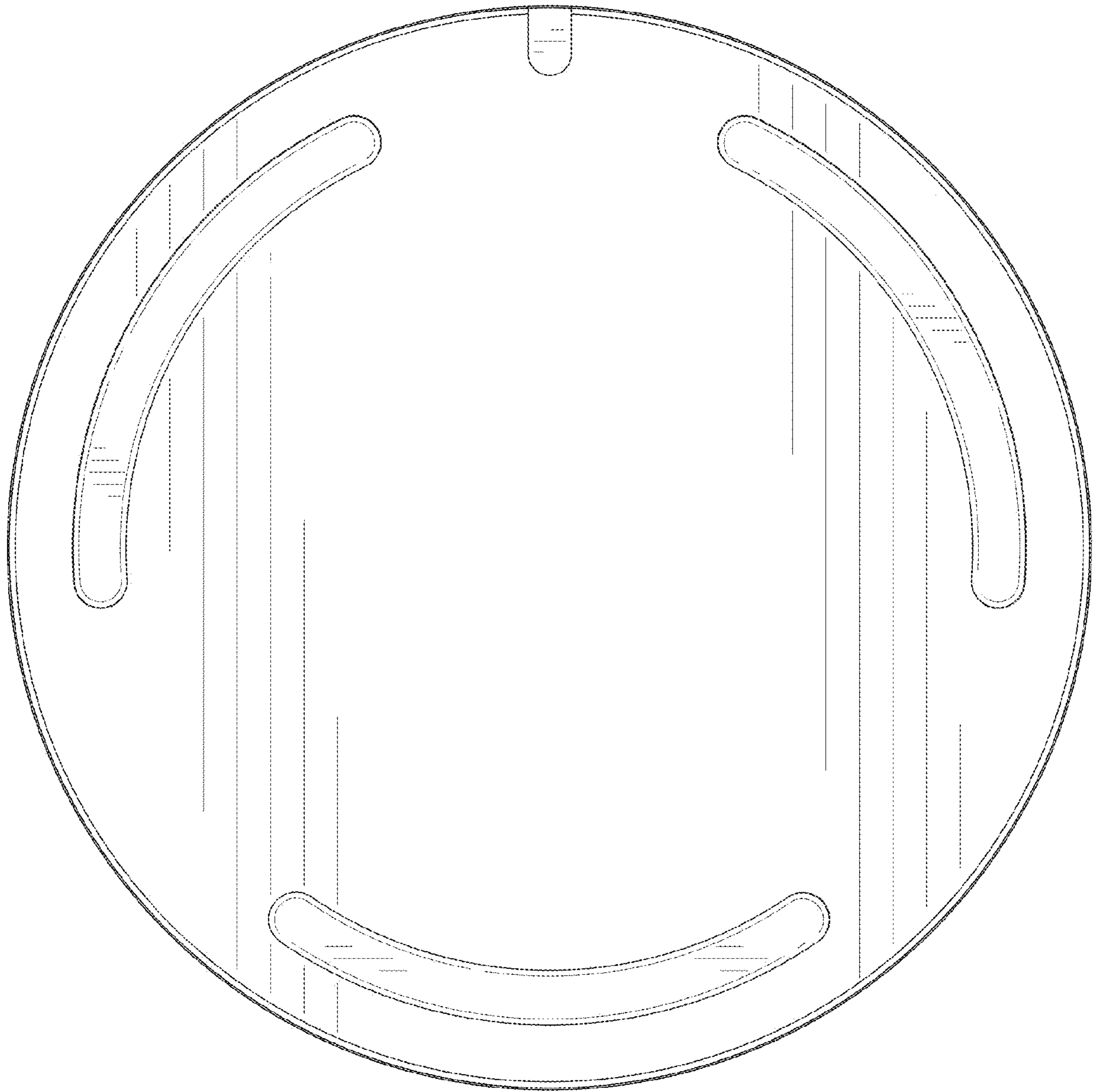

FIG. 23

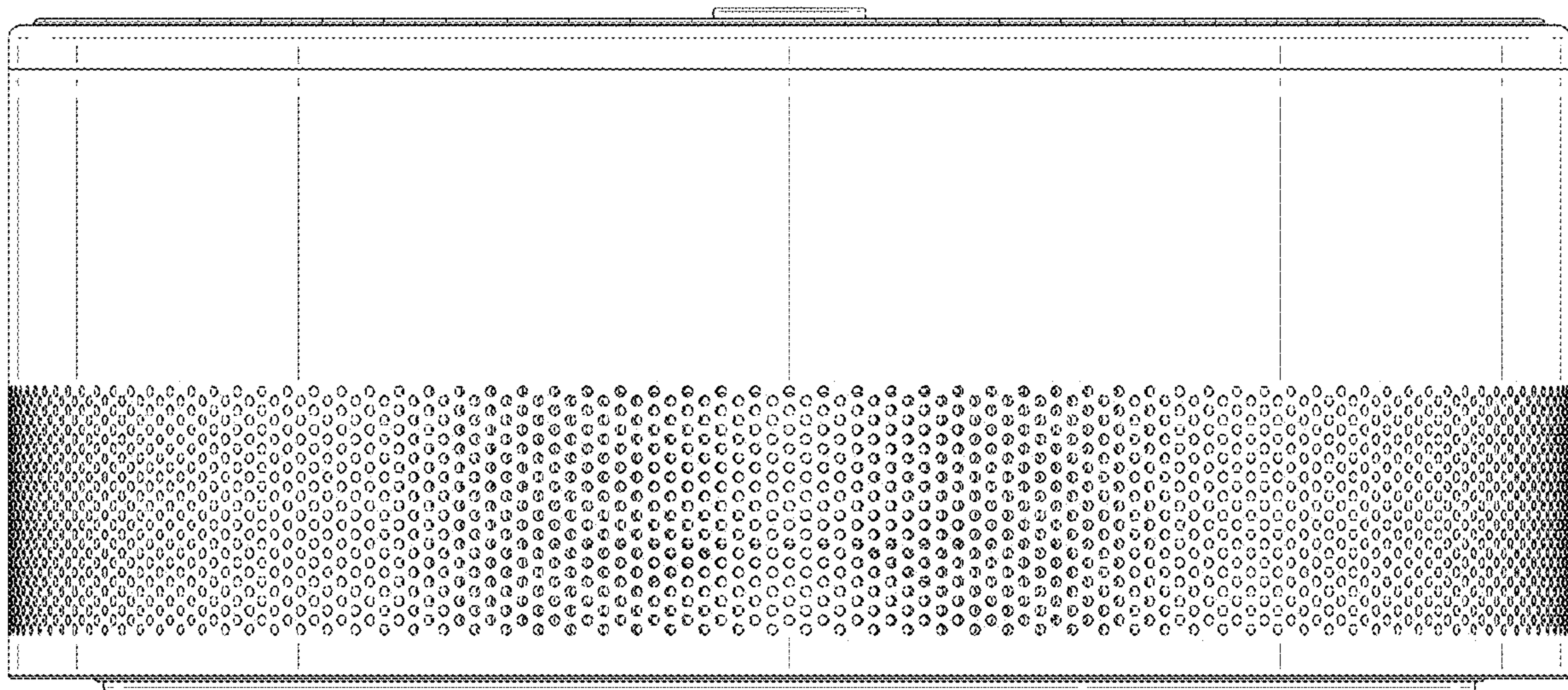

FIG. 24

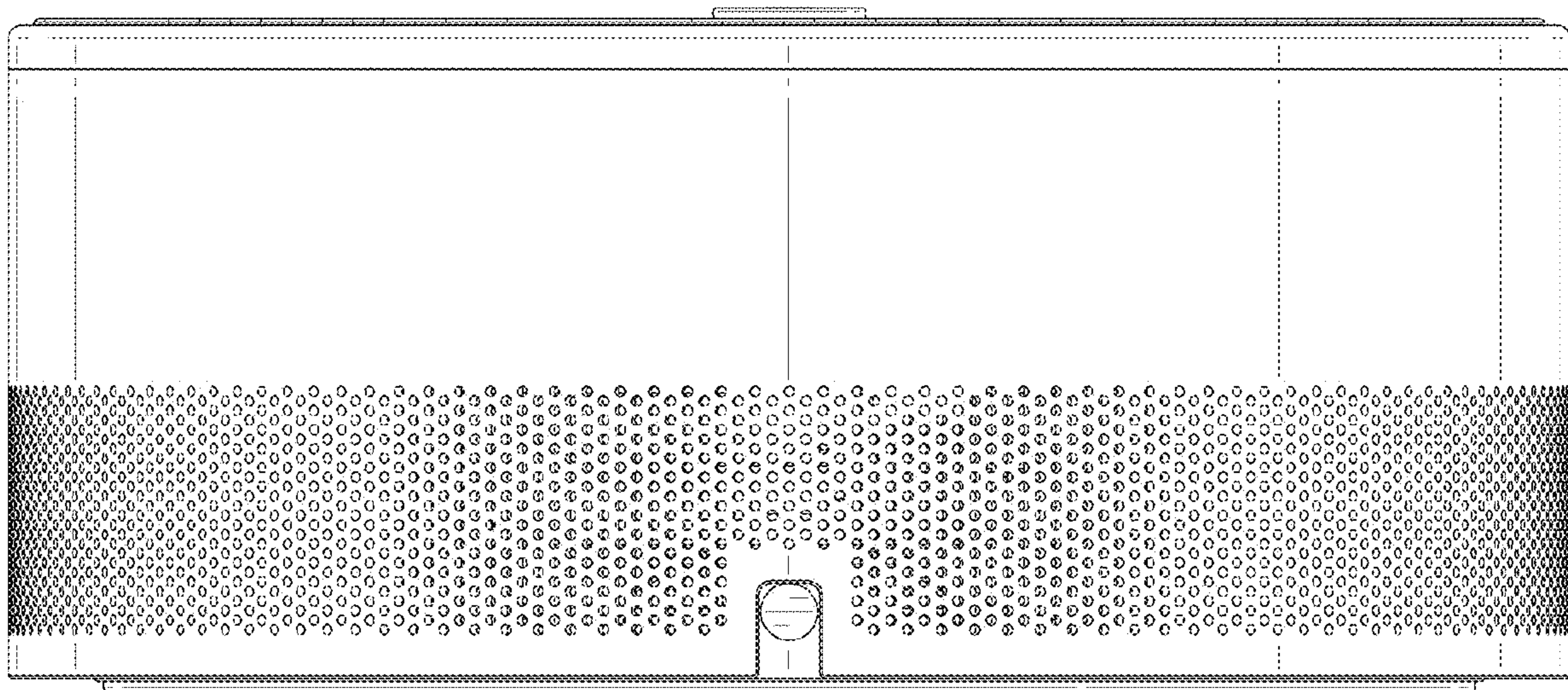

FIG. 25

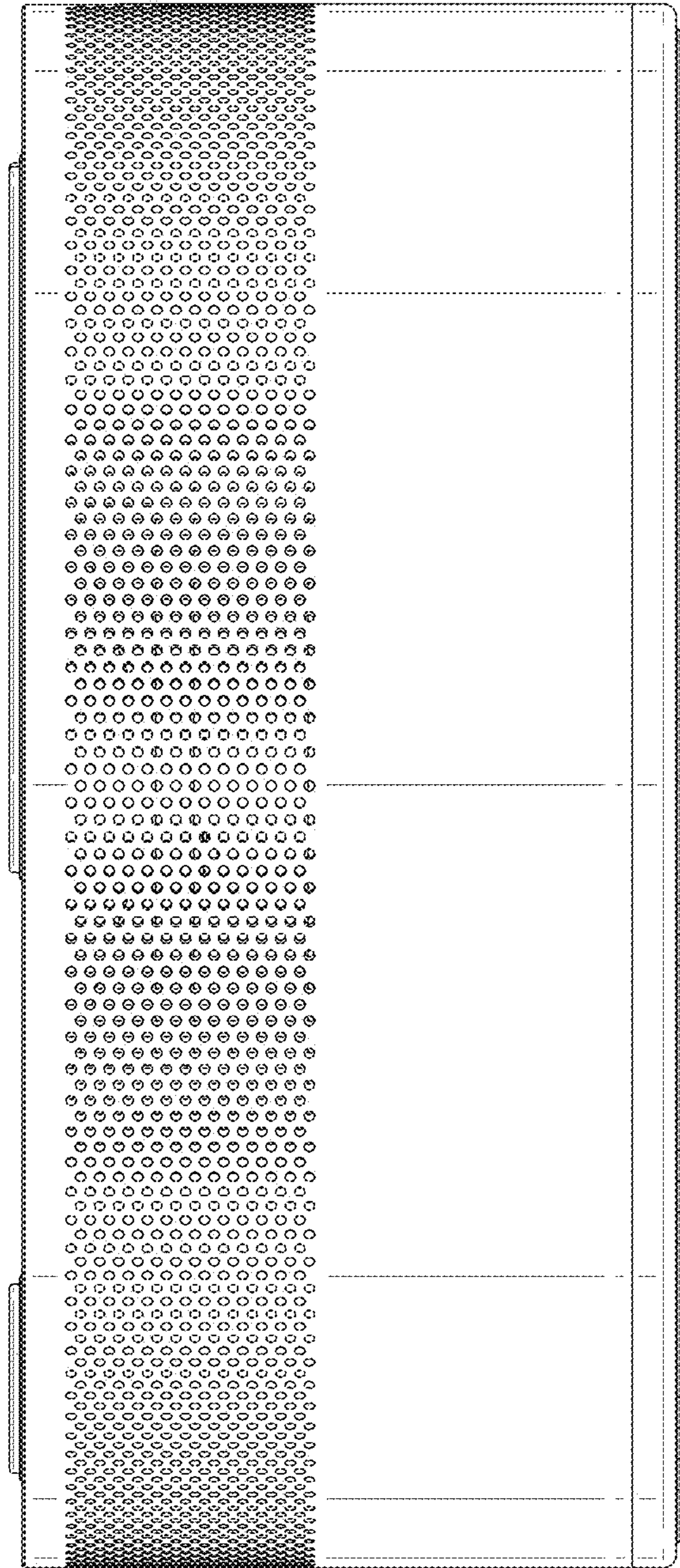

FIG. 26

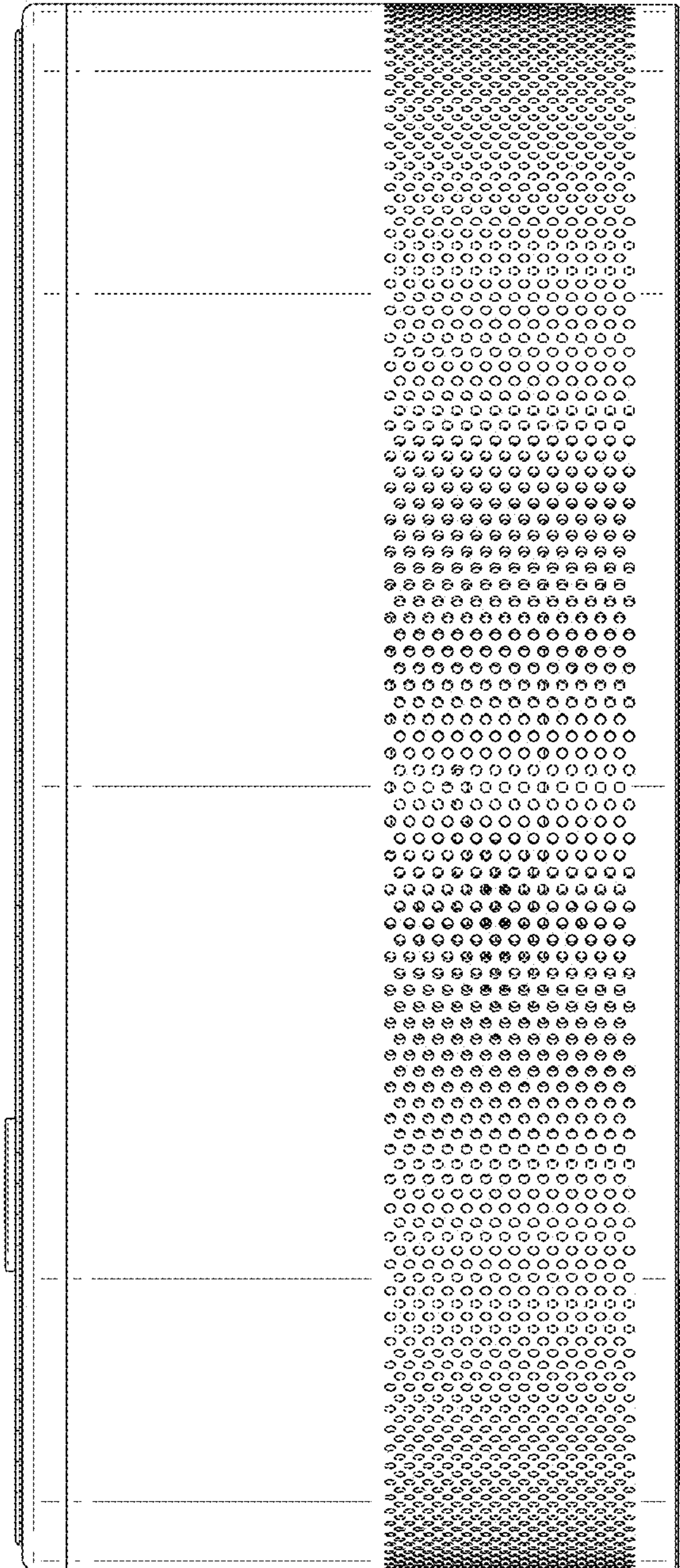

FIG. 27

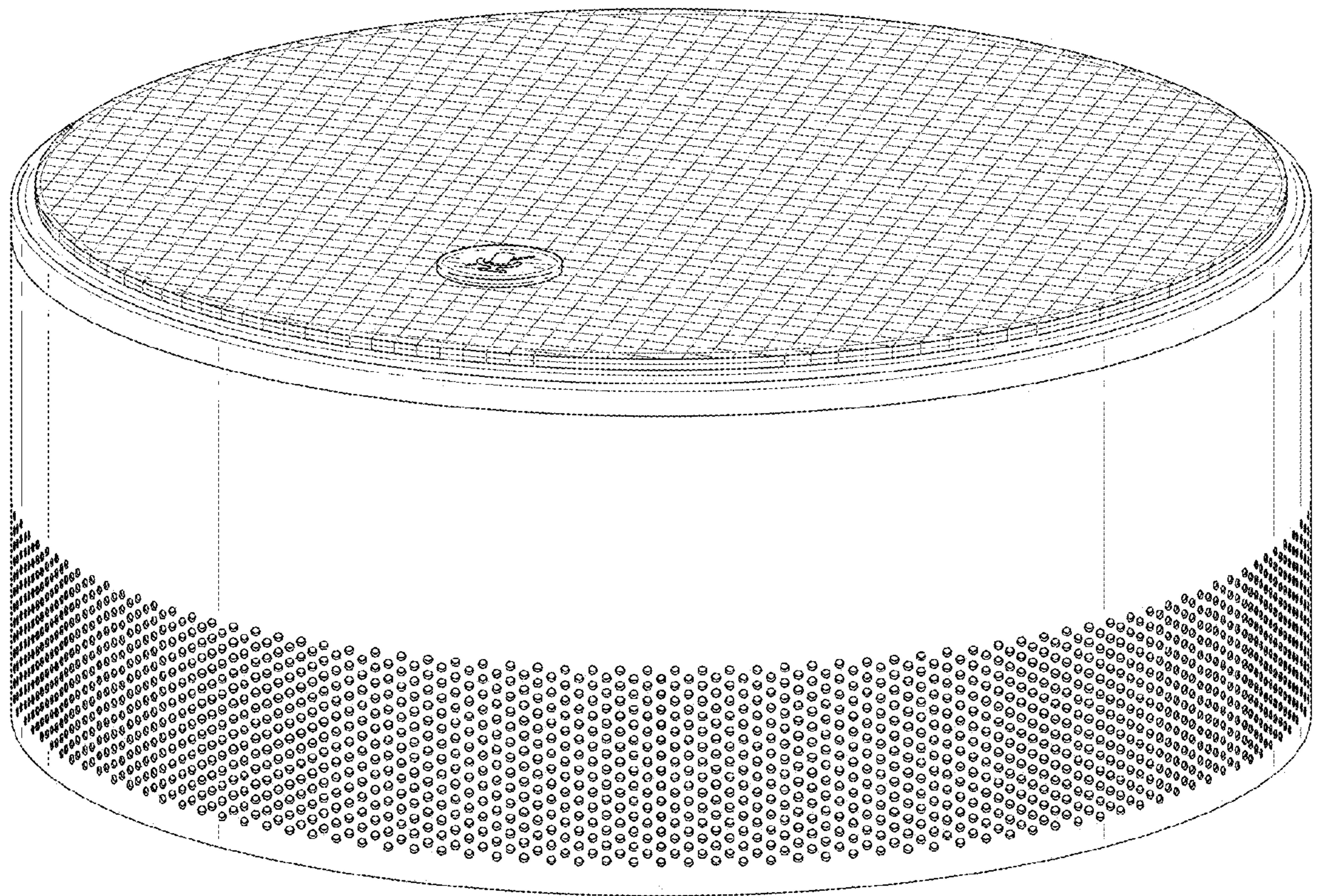

FIG. 28