



US00D982476S

(12) **United States Design Patent** (10) **Patent No.:** **US D982,476 S**
Singer (45) **Date of Patent:** **** Apr. 4, 2023**

(54) **TWIN TUBE VASE**
(71) Applicant: **Steven Singer**, Southampton, PA (US)
(72) Inventor: **Steven Singer**, Southampton, PA (US)
(**) Term: **15 Years**
(21) Appl. No.: **29/753,599**

D951,784 S * 5/2022 Turk D10/65
2010/0086448 A1* 4/2010 Faber A47G 7/06
422/120
2012/0261281 A1* 10/2012 Morgan A47G 7/06
29/428

FOREIGN PATENT DOCUMENTS

CN 303346872 * 8/2015
FR 864159-001 * 9/1986

OTHER PUBLICATIONS

Gold dipped roses. Online [website]. Instagram, posted online by user @sherryrosetti on May 6, 2022 [retrieved on Nov. 23, 2022]. Retrieved from the internet: <https://www.instagram.com/p/CdNymWRM_wg/>. (Year: 2022).*

* cited by examiner

Primary Examiner — Tracey J Bell
Assistant Examiner — Grace Doyle
(74) *Attorney, Agent, or Firm* — Riddle Patent Law, LLC; Charles L. Riddle, Esq.

(22) Filed: **Oct. 1, 2020**
(51) **LOC (14) Cl.** **11-02**
(52) **U.S. Cl.**
USPC **D11/147**
(58) **Field of Classification Search**
USPC ... D11/131, 131.1, 143, 144, 145, 146, 154, D11/155, 164; D6/556, 558; D3/316, D3/317; D19/84, 85, 105; D8/354
CPC ... A47G 7/02; A47G 7/04; A47G 7/06; A47G 7/025; A47G 29/08; A61G 17/045; A47F 7/0021; B43K 23/002; B43M 99/008; A01G 9/028; A01G 9/0295
See application file for complete search history.

(57) **CLAIM**

The ornamental design for a twin tube vase, as shown and described.

(56) **References Cited**

U.S. PATENT DOCUMENTS

D108,626 S * 3/1938 Norton D11/146
D161,749 S * 1/1951 Griner A47G 7/06
D11/147
D346,763 S * 5/1994 Smith D11/144
D357,886 S * 5/1995 Fuller D11/152
D376,714 S * 12/1996 Dallimore A47G 7/06
D11/152
D377,960 S * 2/1997 Wood D22/120
D400,426 S * 11/1998 Gillin D8/354
D401,016 S * 11/1998 Holliday D28/38
D574,117 S * 7/2008 Gregory D11/146
D950,411 S * 5/2022 Rozek D11/146

DESCRIPTION

FIG. 1 is a top perspective view of a twin tube vase;
FIG. 2 is a bottom perspective view thereof;
FIG. 3 top view thereof;
FIG. 4 is a bottom view thereof;
FIG. 5 is a is a side view thereof;
FIG. 6 is a is a side view thereof;
FIG. 7 is a is a front view thereof; and,
FIG. 8 is a back view thereof.

1 Claim, 4 Drawing Sheets

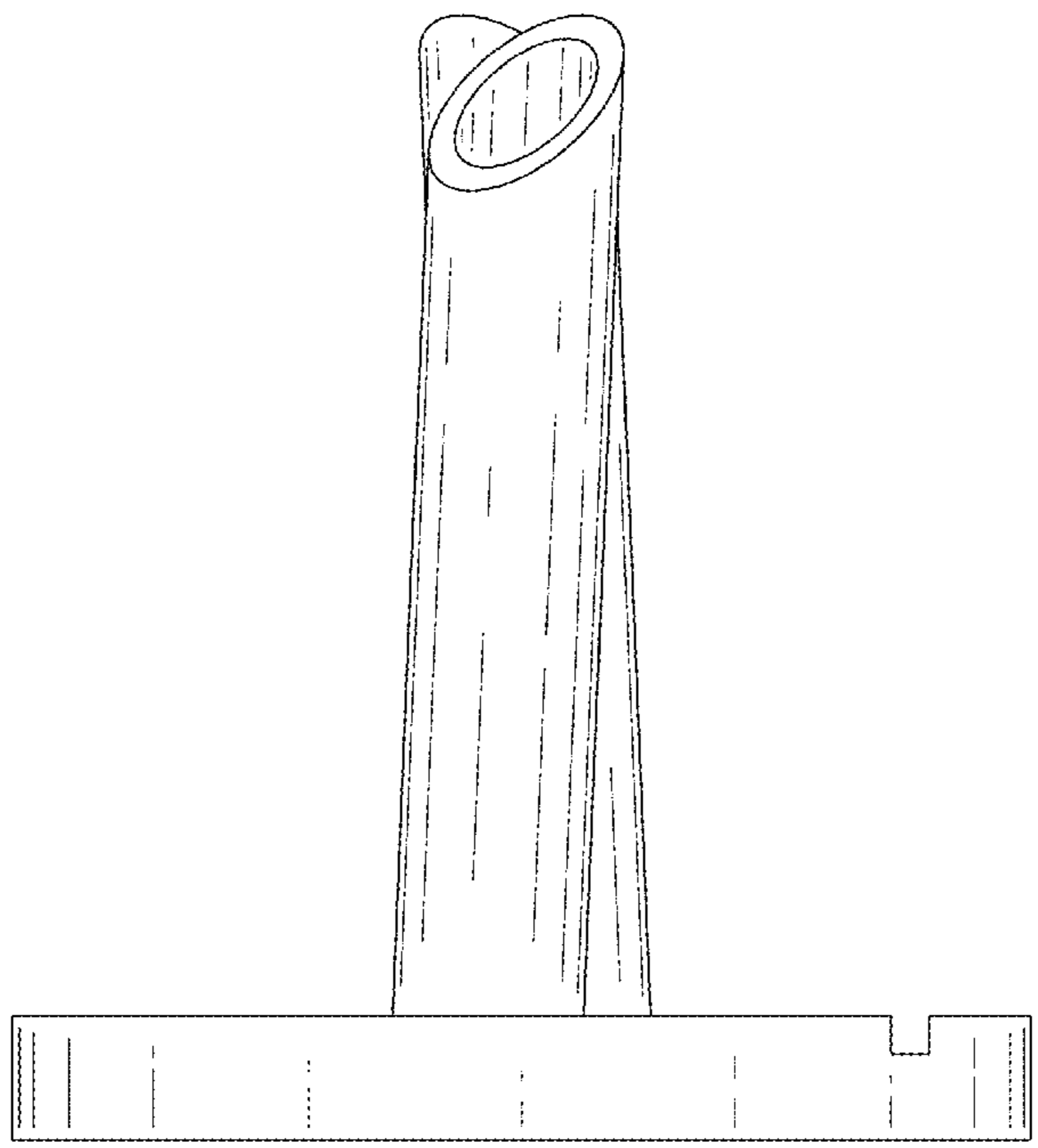

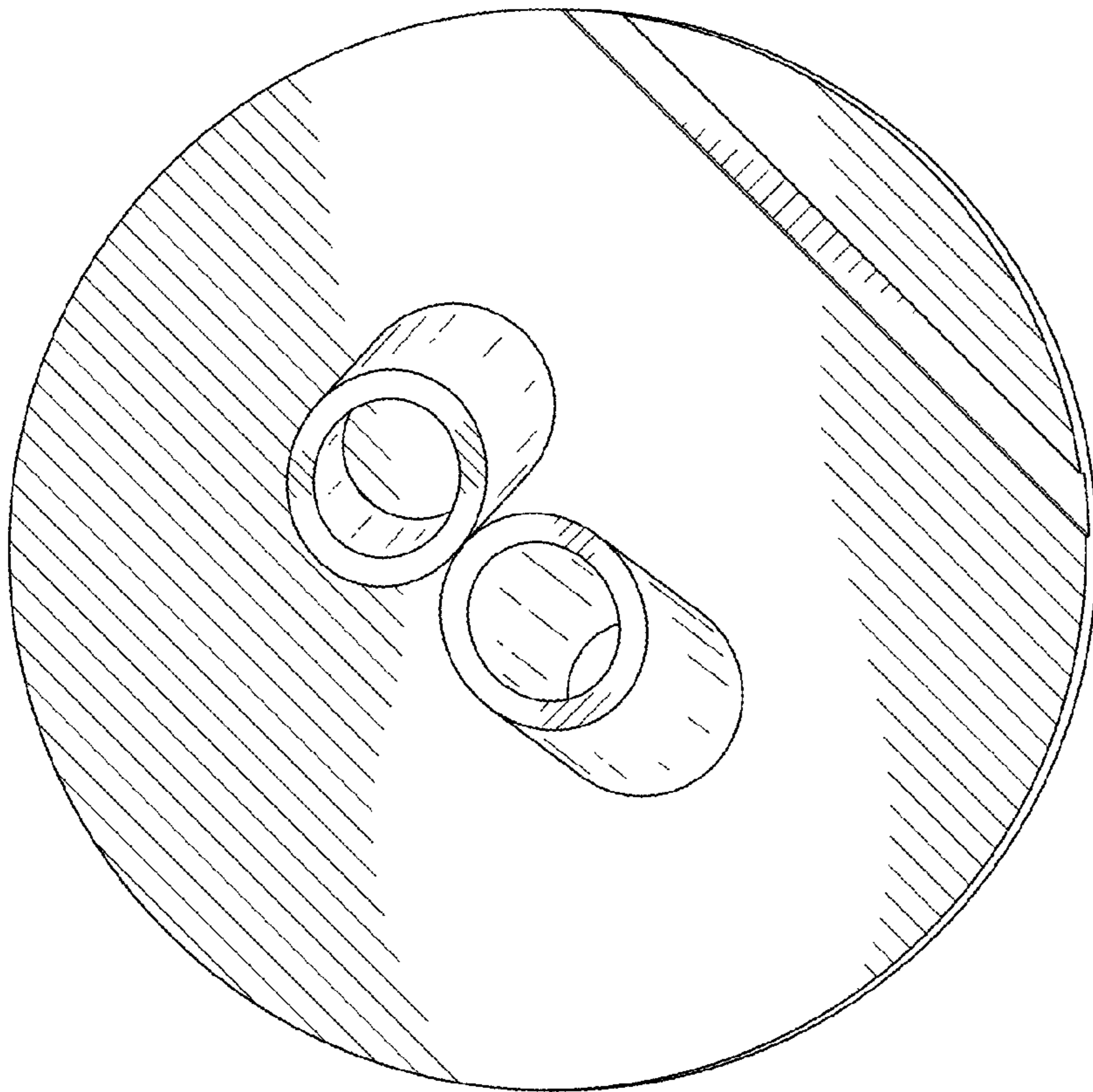

FIG. 1

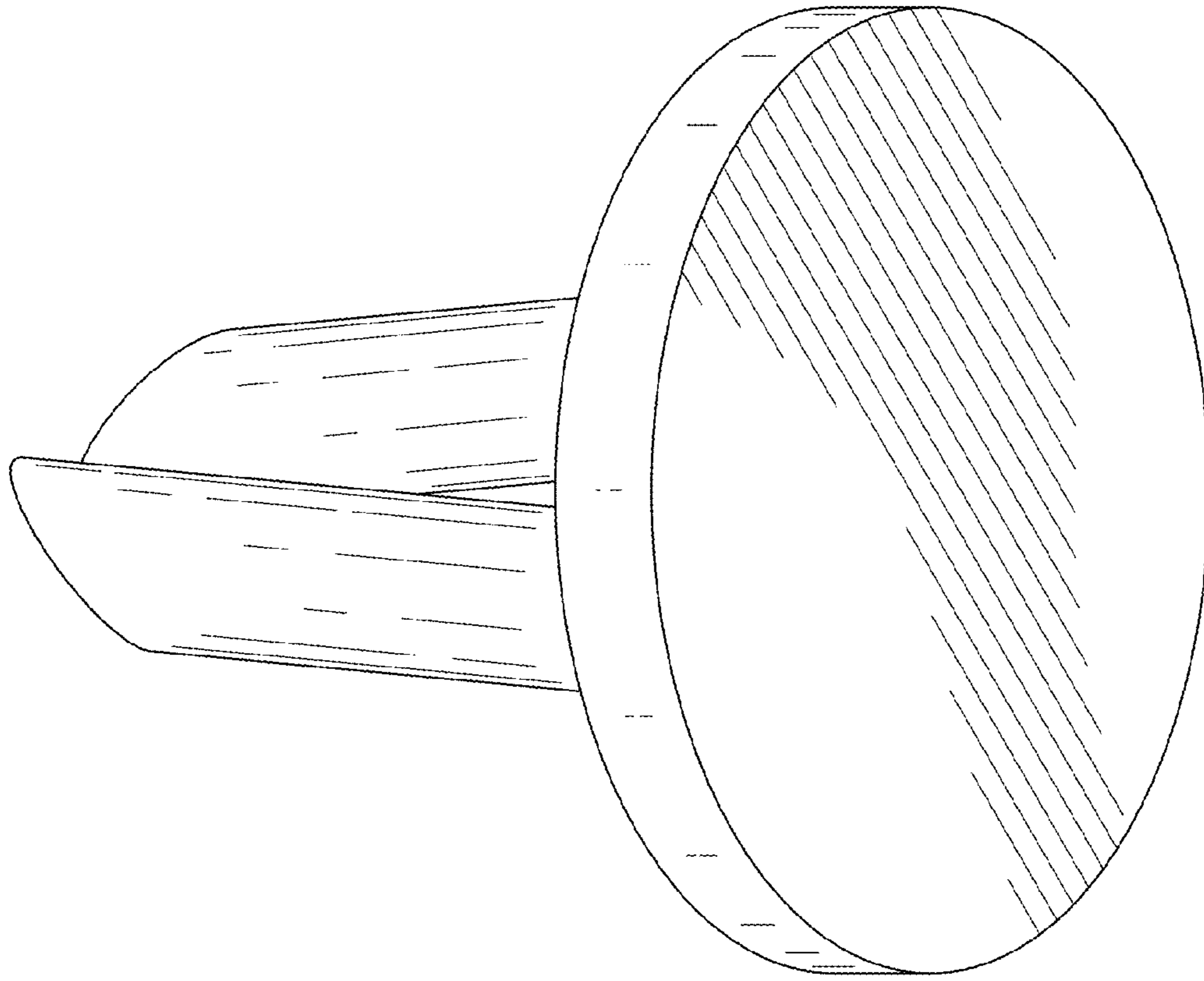

FIG. 2

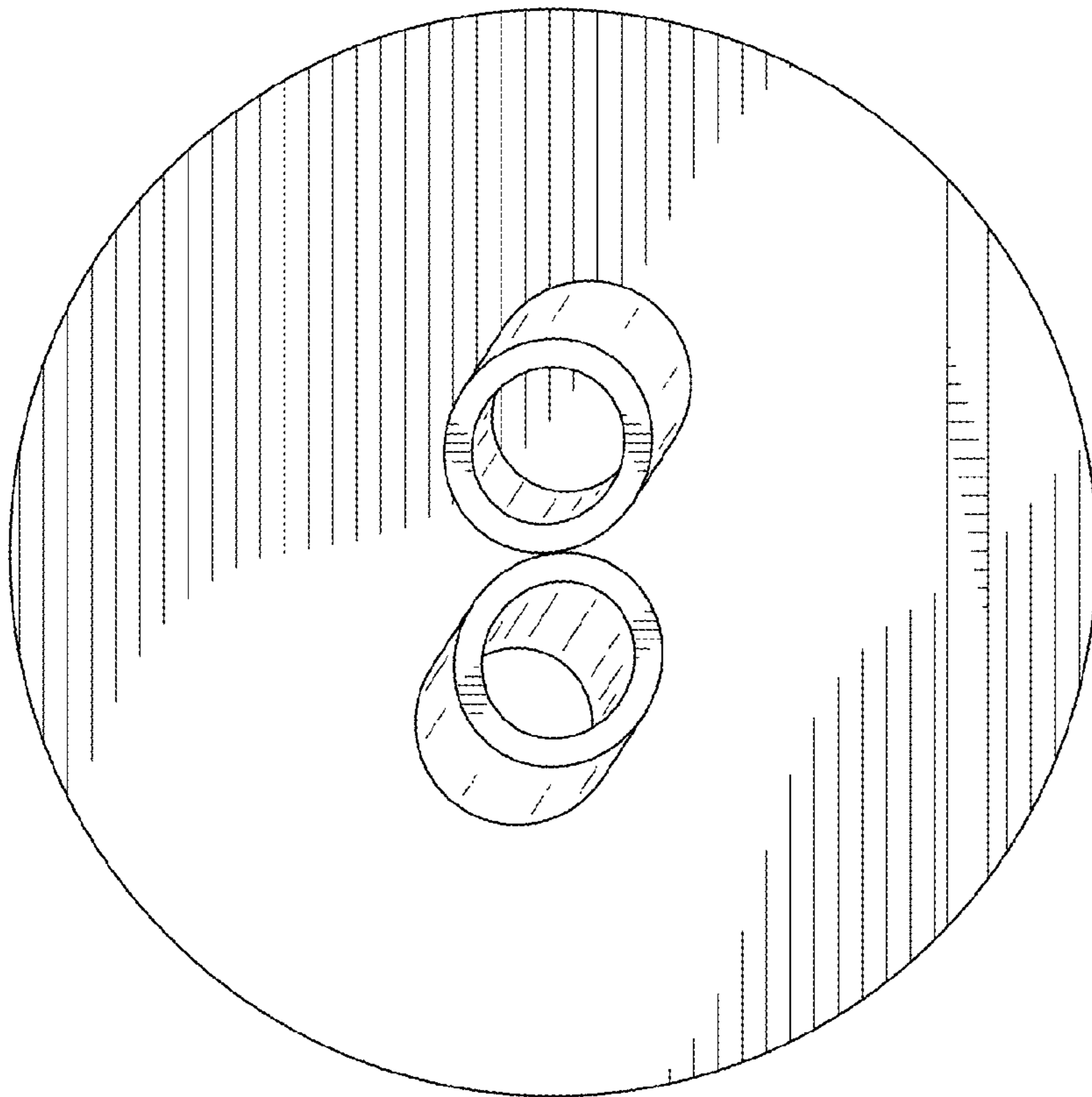

FIG. 3

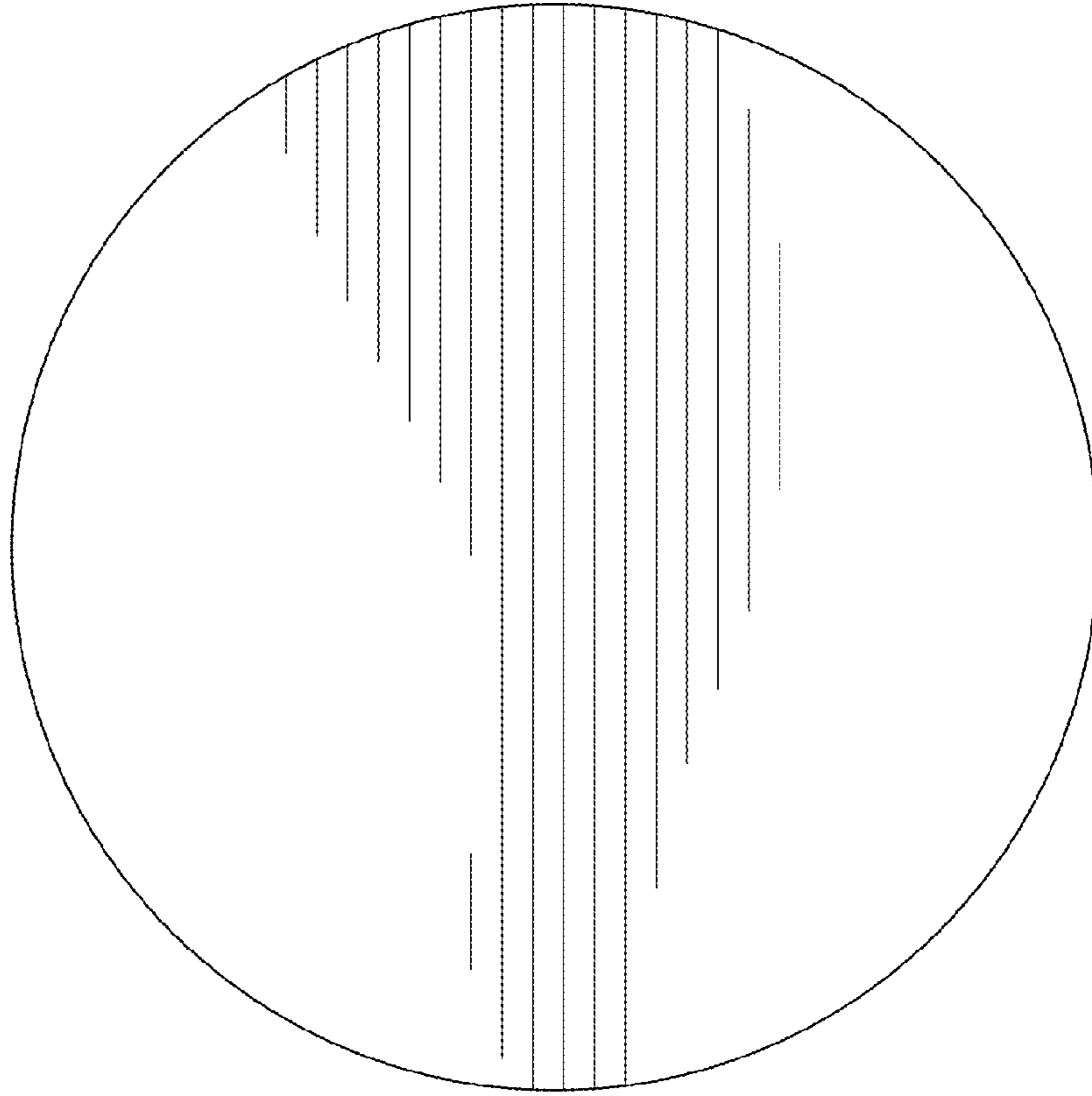

FIG. 4

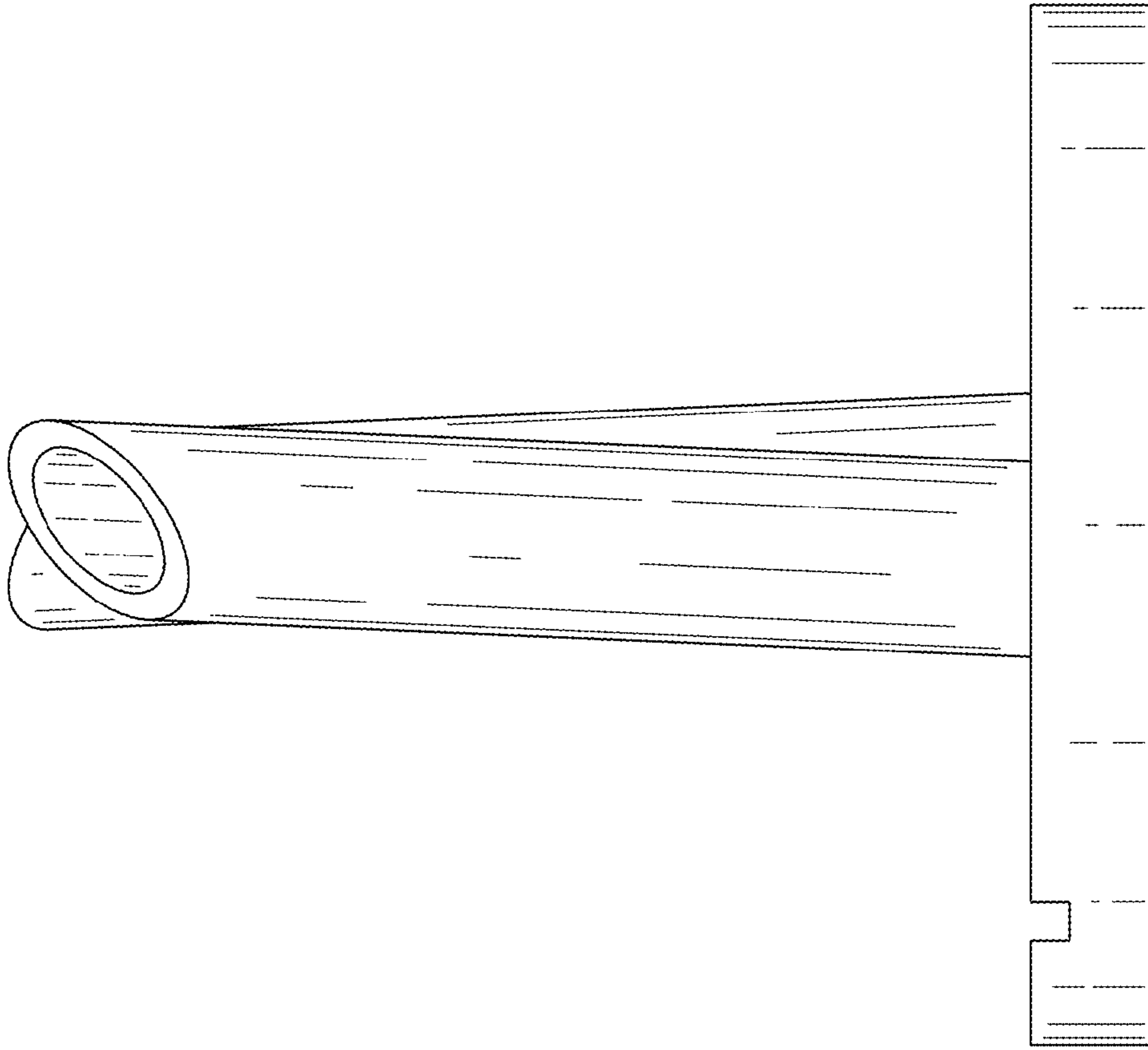

FIG. 5

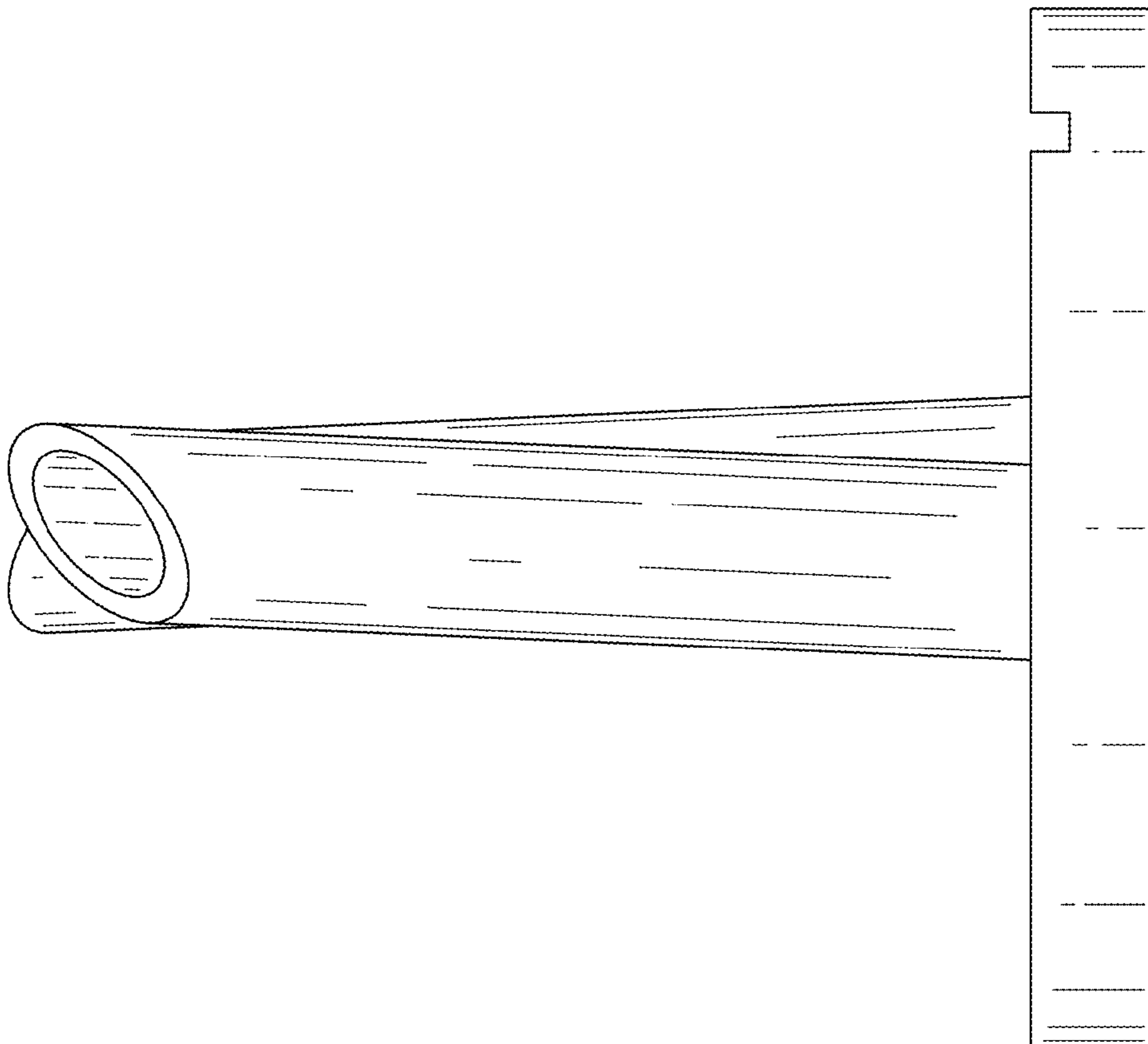

FIG. 6

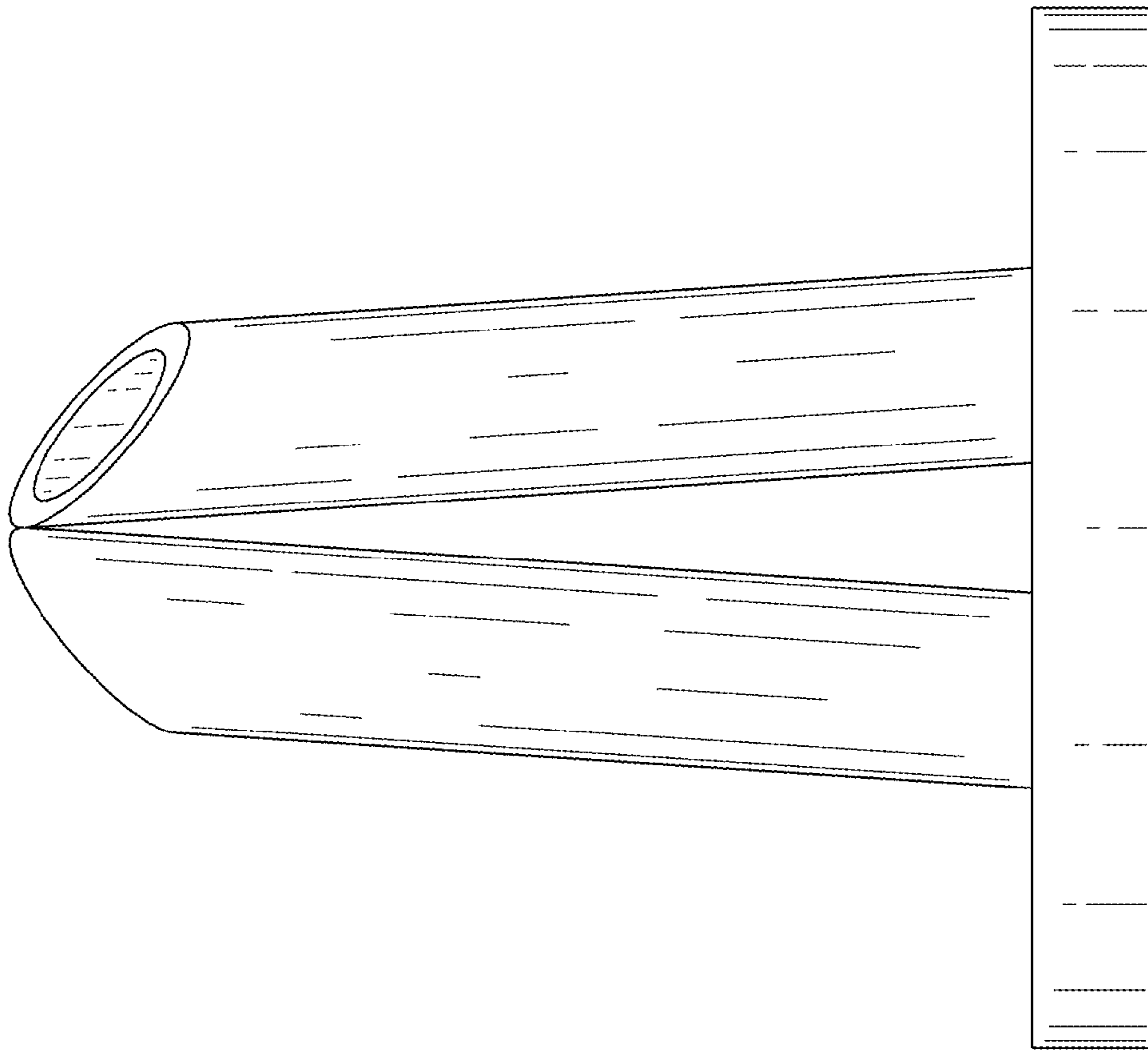

FIG. 8

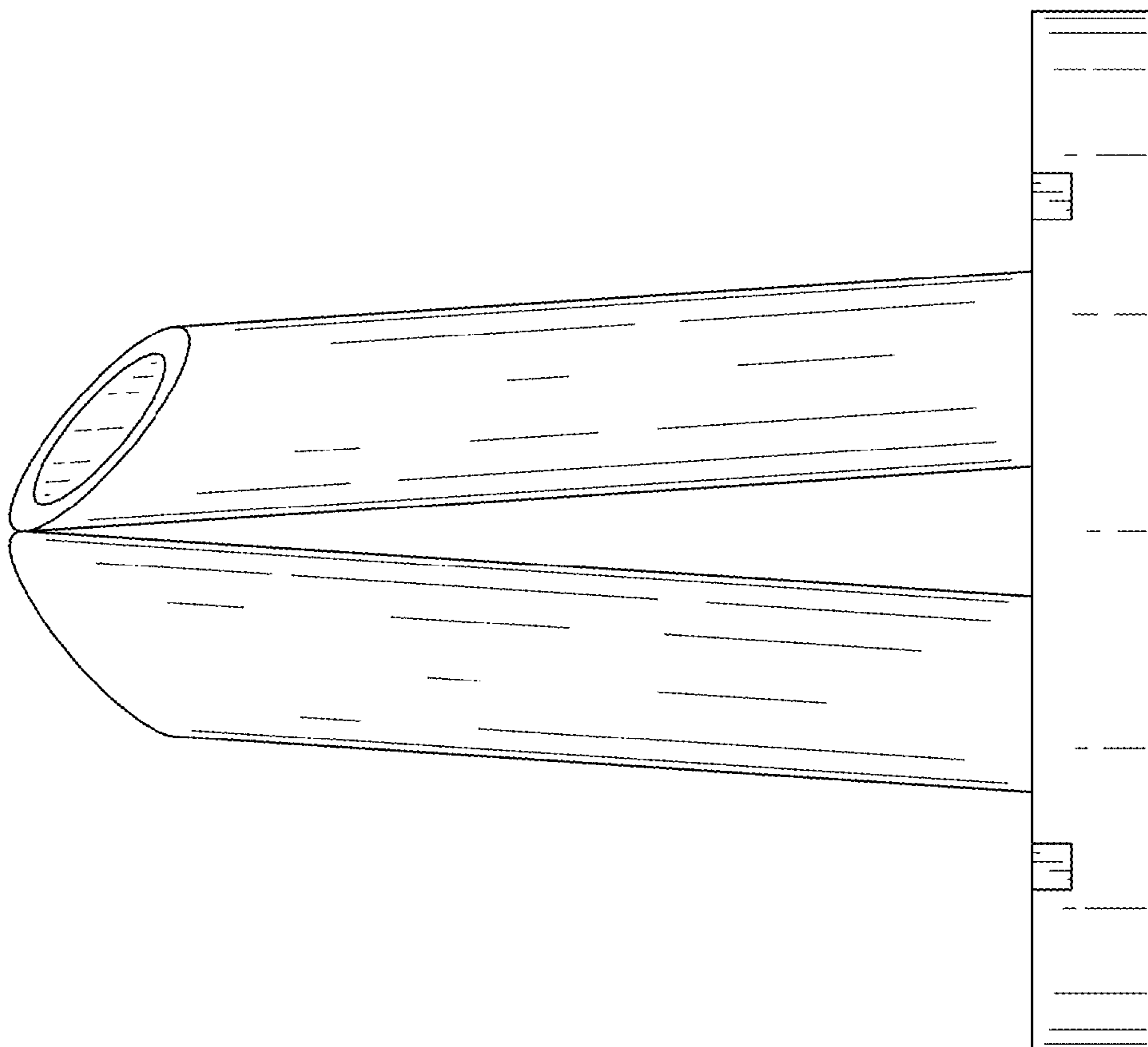

FIG. 7