



US00D982398S

(12) **United States Design Patent** (10) **Patent No.:** **US D982,398 S**
Whitehead et al. (45) **Date of Patent:** **** Apr. 4, 2023**

(54) **RAKE HEAD WITH HAND RAKE SET**

(71) Applicant: **Suncast Technologies, LLC**, Palm Beach Gardens, FL (US)

(72) Inventors: **Stephen Whitehead**, Elgin, IL (US); **Torrence Anderson**, Overland Park, KS (US); **Charles Shotola**, La Grange Park, IL (US)

(73) Assignee: **Suncast Technologies, LLC**, Palm Beach Gardens, FL (US)

(**) Term: **15 Years**

(21) Appl. No.: **29/766,068**

(22) Filed: **Jan. 13, 2021**

(51) **LOC (14) Cl.** **08-01**

(52) **U.S. Cl.**
USPC **D8/13**

(58) **Field of Classification Search**
USPC D8/1, 13; 56/400.17, 400.21, 400.01
CPC A01D 7/00
See application file for complete search history.

(56) **References Cited**

U.S. PATENT DOCUMENTS

D10,532 S *	3/1878	Beebe	D8/1
764,401 A *	7/1904	Wegner	A01D 7/00
				56/400.04
D54,878 S *	4/1920	Tsuchiya	D8/13
1,610,842 A *	12/1926	Young	A01D 7/06
				56/400.21
2,883,820 A *	4/1959	Bissell	A01D 7/06
				56/400.17
D198,860 S *	8/1964	Fedorka, Jr.	D8/13

(Continued)

Primary Examiner — Rachel A. Voorhies

Assistant Examiner — Benjamin D. Wannemacher

(74) *Attorney, Agent, or Firm* — McHale & Slavin, P.A.

(57) **CLAIM**

The ornamental design for a rake head with hand rake set, as shown and described.

DESCRIPTION

FIG. 1 is a top front right perspective view of the rake head of the present invention shown separately for ease of illustration;

FIG. 2 is a front view thereof;

FIG. 3 is a rear view thereof;

FIG. 4 is a right side view thereof;

FIG. 5 is a left side view thereof;

FIG. 6 is a top view thereof;

FIG. 7 is a bottom view thereof;

FIG. 8 is a top front right perspective view of the hand rake of the present invention shown separately for ease of illustration;

FIG. 9 is a top rear left perspective view thereof;

FIG. 10 is a front view thereof;

FIG. 11 is a rear view thereof;

FIG. 12 is a right side view thereof;

FIG. 13 is a left side view thereof;

FIG. 14 is a top front right perspective view of the combined rake head with hand rake set according to the claimed design;

FIG. 15 is a front view thereof;

FIG. 16 is a rear view thereof;

FIG. 17 is a right side view thereof; and,

FIG. 18 is a left side view thereof.

The claimed design is directed to the collective appearance of the rake head with hand rake set.

The portions of the figures illustrated in dash-dash broken lines illustrate portions of the rake head with hand rake set that form no part of the claimed design.

The portions of the rake handle illustrated in dash-dash lines, and portions of the figures illustrated in dash-dot lines illustrate environment of the rake head with hand rake set and form no part of the claimed design.

1 Claim, 14 Drawing Sheets

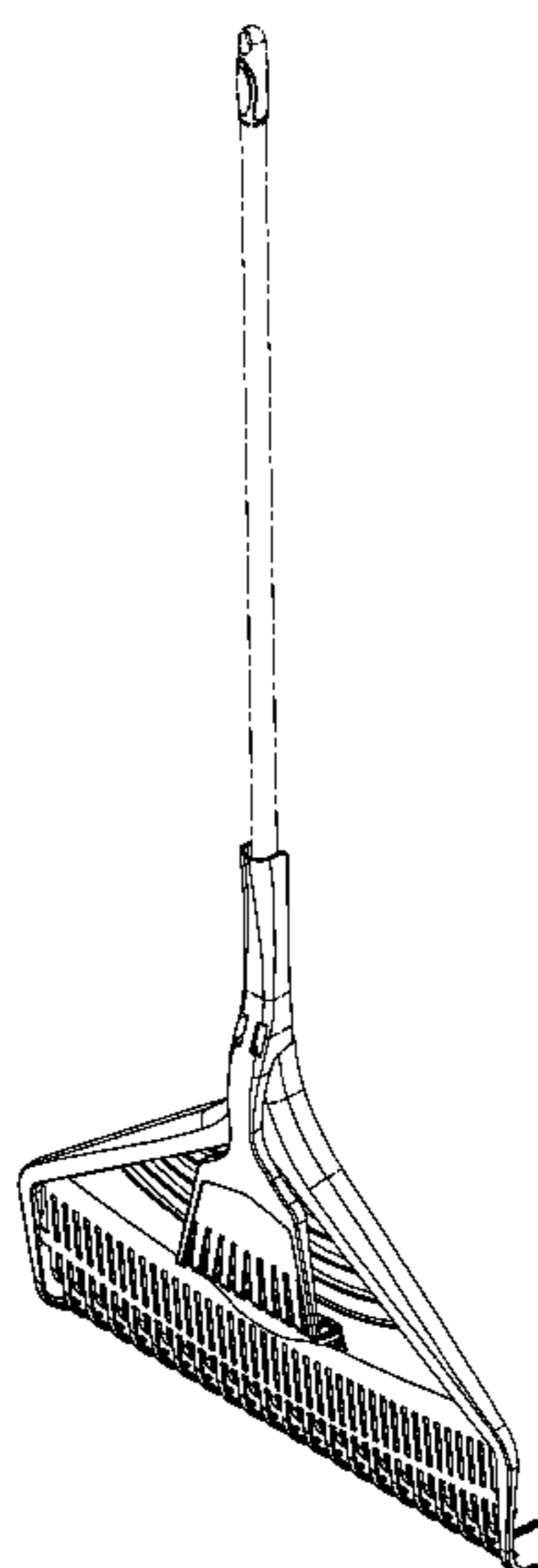

(56)

References Cited

U.S. PATENT DOCUMENTS

3,164,945 A * 1/1965 Spencer A01D 7/10
294/50.8
3,332,223 A * 7/1967 Polisso A01D 7/00
56/400.17
D223,743 S * 6/1972 Vaughan D8/13
D223,794 S * 6/1972 Hart D8/13
D230,558 S * 3/1974 Laible A01D 7/00
D8/13
D233,305 S * 10/1974 Eads D8/13
D248,612 S * 7/1978 Oas D8/13
D256,880 S * 9/1980 Brock, Jr. D8/13
4,219,993 A * 9/1980 Cosmos A01D 7/00
56/400.17
D292,261 S * 10/1987 Mitton D8/13
D311,310 S * 10/1990 Clivio D8/13
D350,052 S * 8/1994 Sun D8/13
D353,979 S * 1/1995 Sargeant D8/13
D369,073 S * 4/1996 Sun D8/13
D391,132 S * 2/1998 Gandee D8/13
D391,814 S * 3/1998 Lindsey D8/13
D393,786 S * 4/1998 Hession D8/13
D505,304 S * 5/2005 Conaway D8/13
D579,289 S * 10/2008 Norton D8/13

* cited by examiner

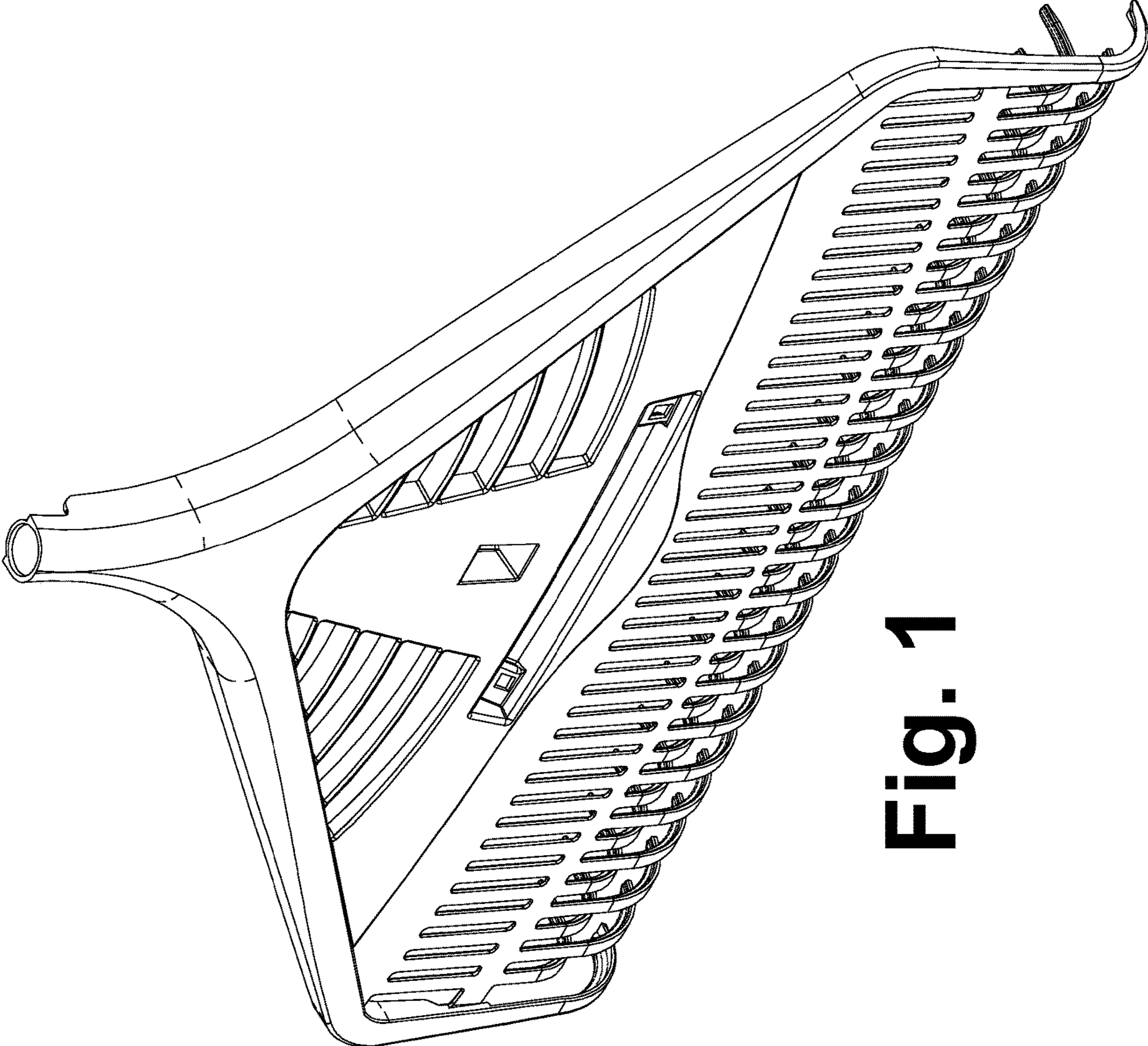

Fig. 1

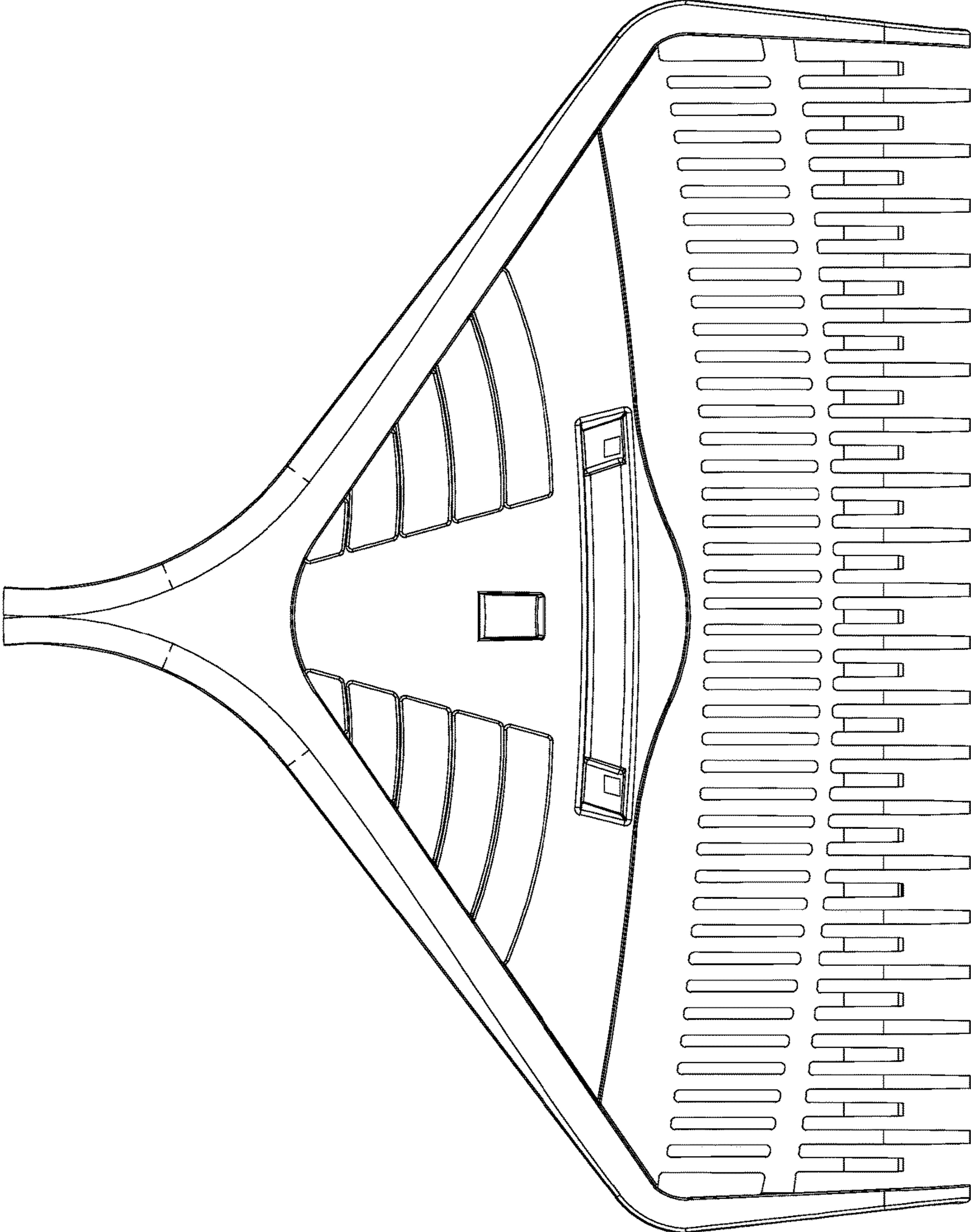

Fig. 2

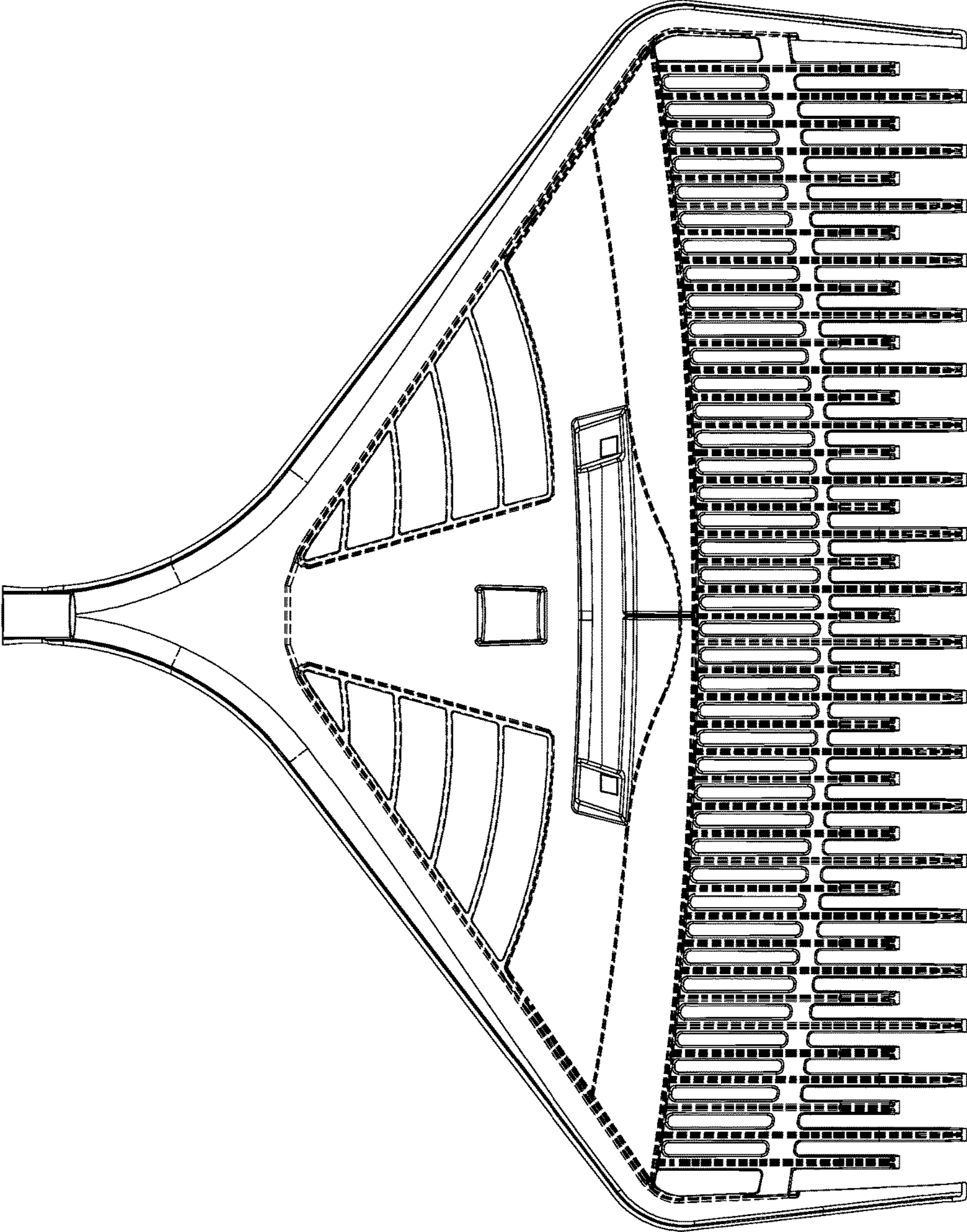

Fig. 3

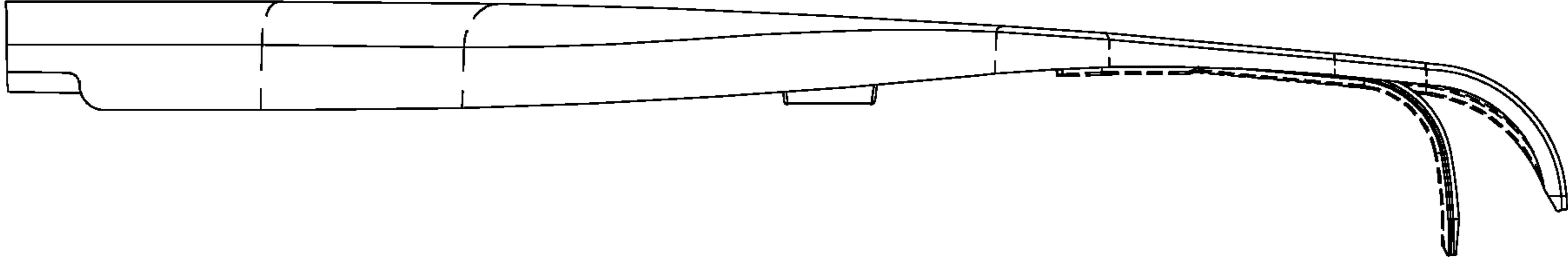

Fig. 5

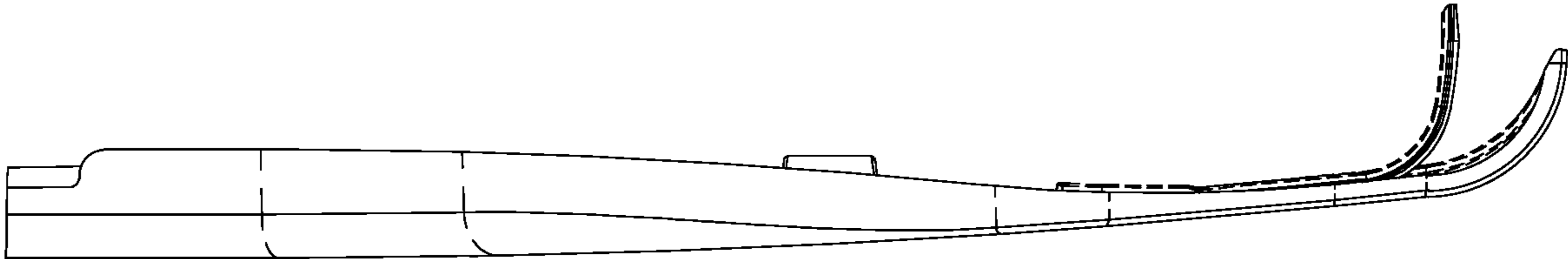

Fig. 4

Fig. 6

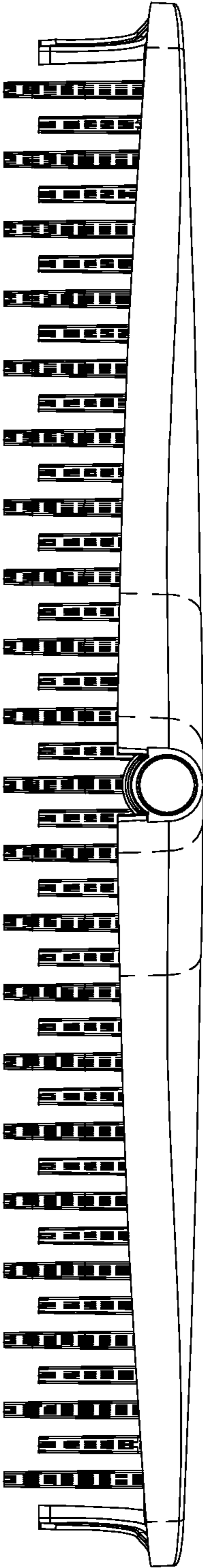
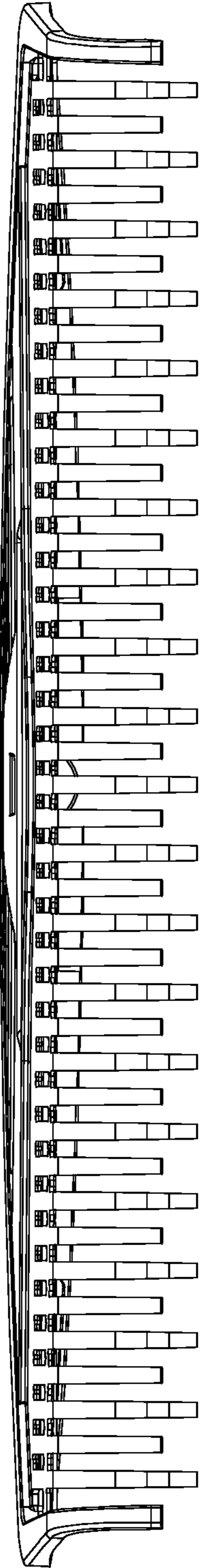

Fig. 7



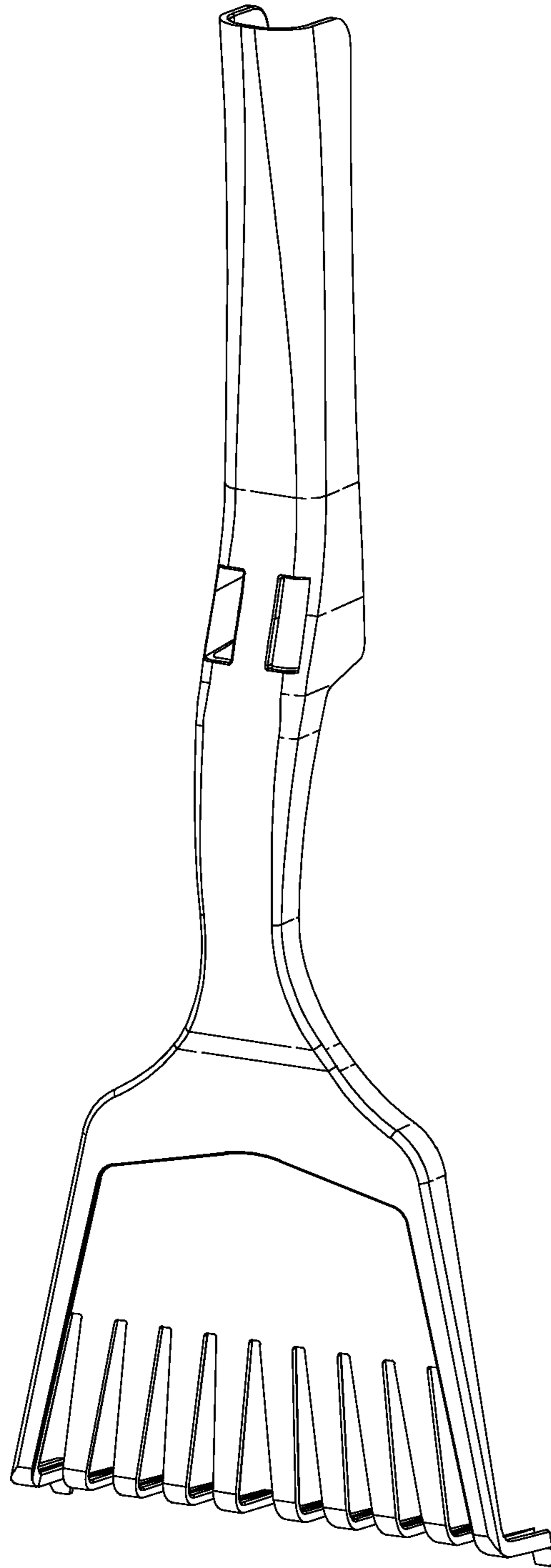

Fig. 8

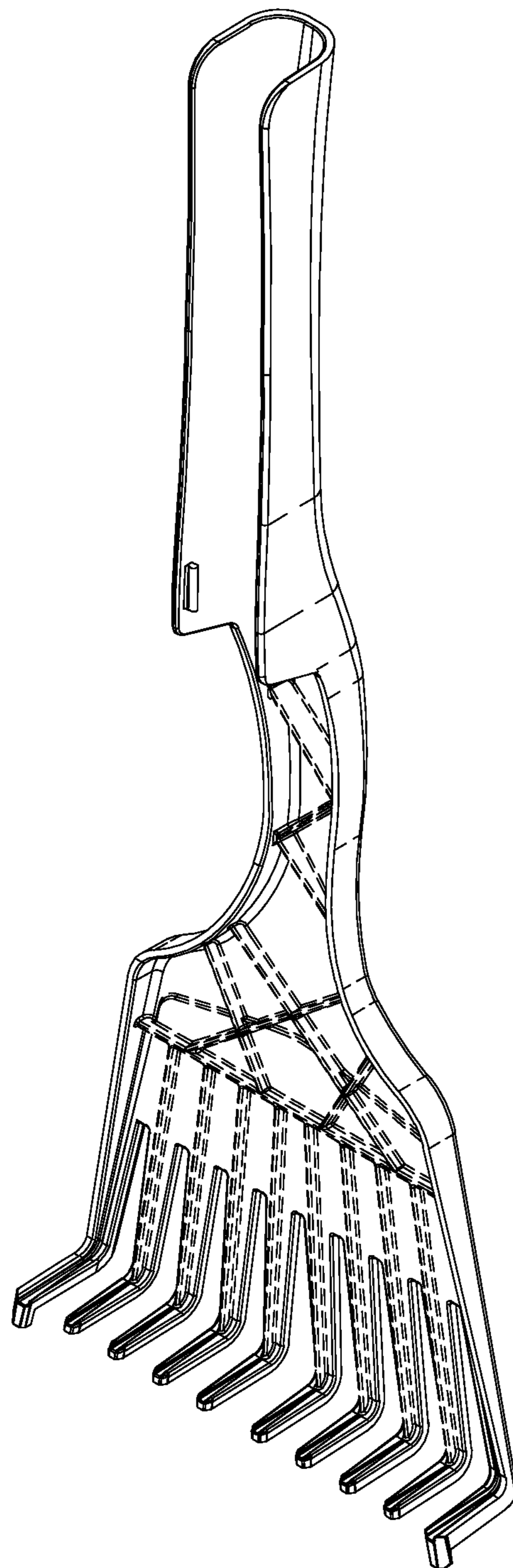

Fig. 9

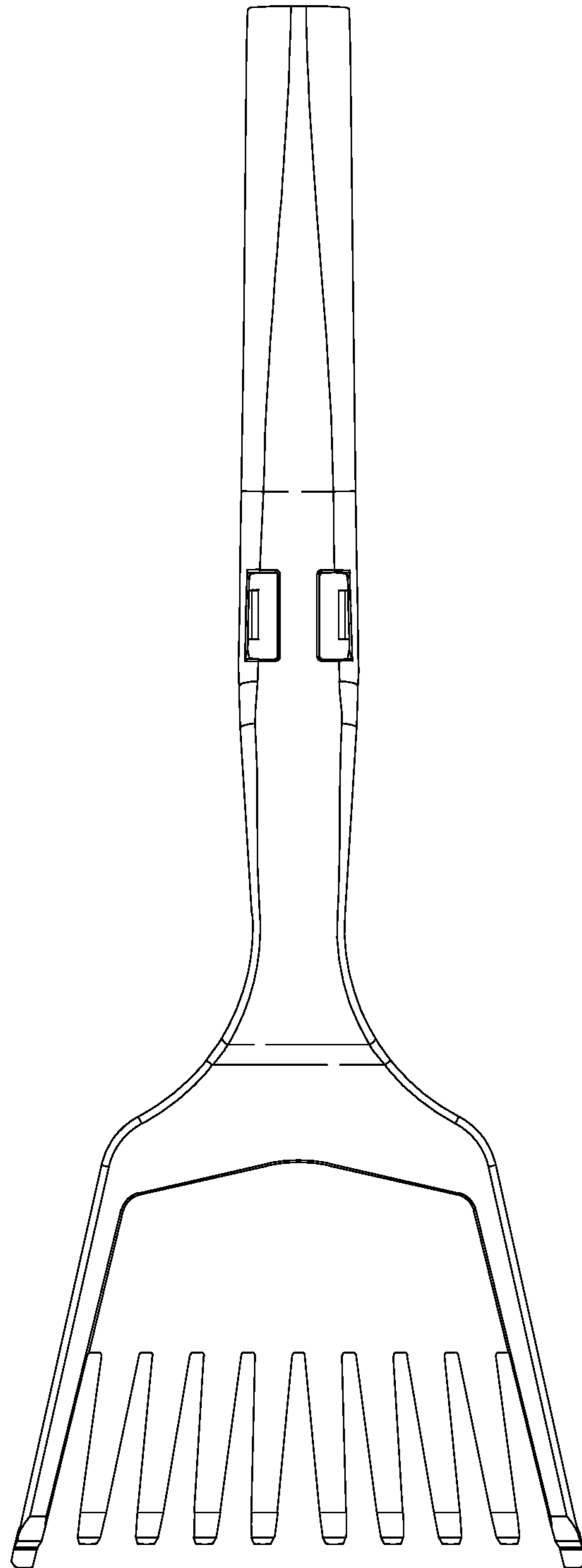

Fig. 10

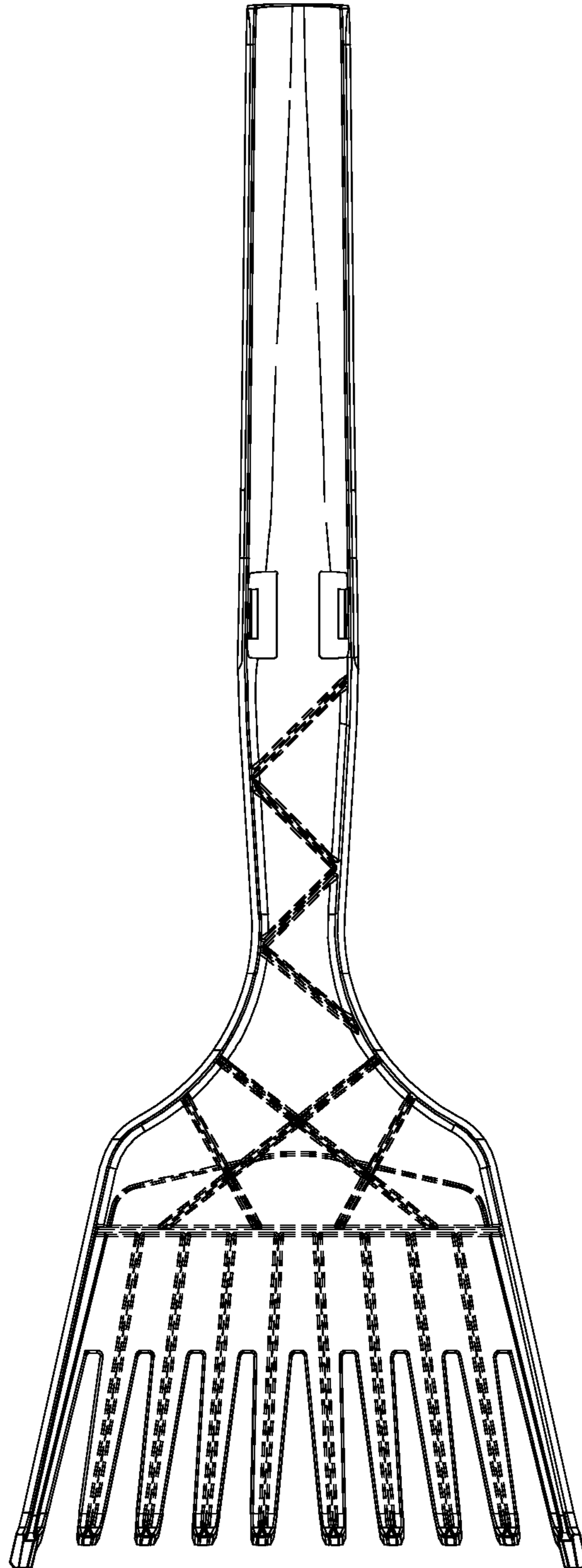

Fig. 11

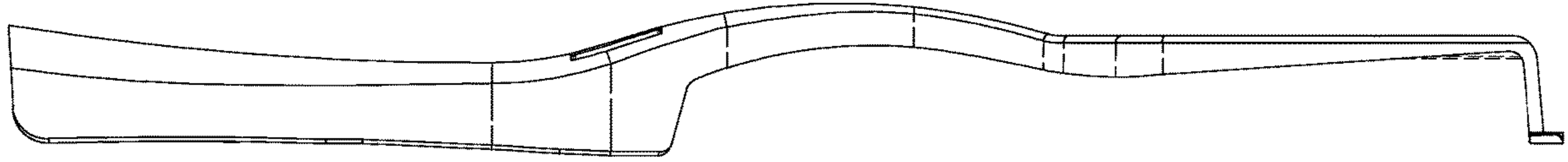

Fig. 13

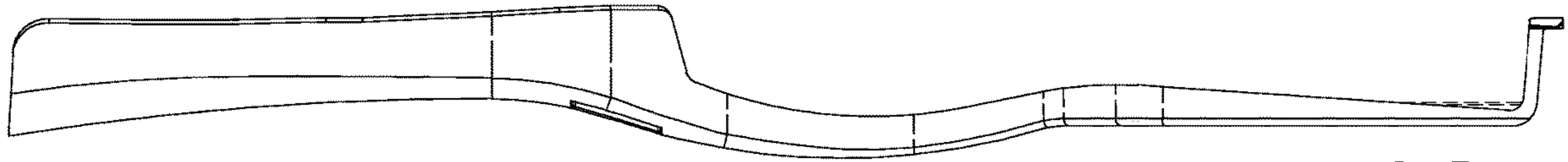

Fig. 12

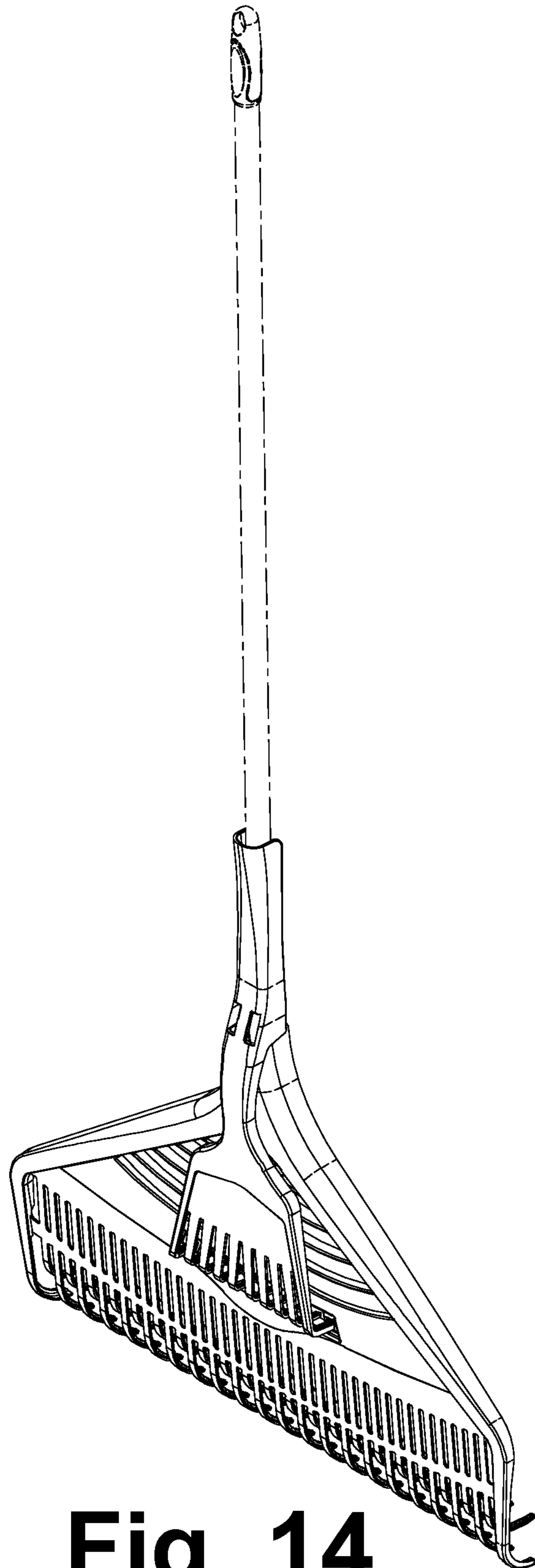

Fig. 14

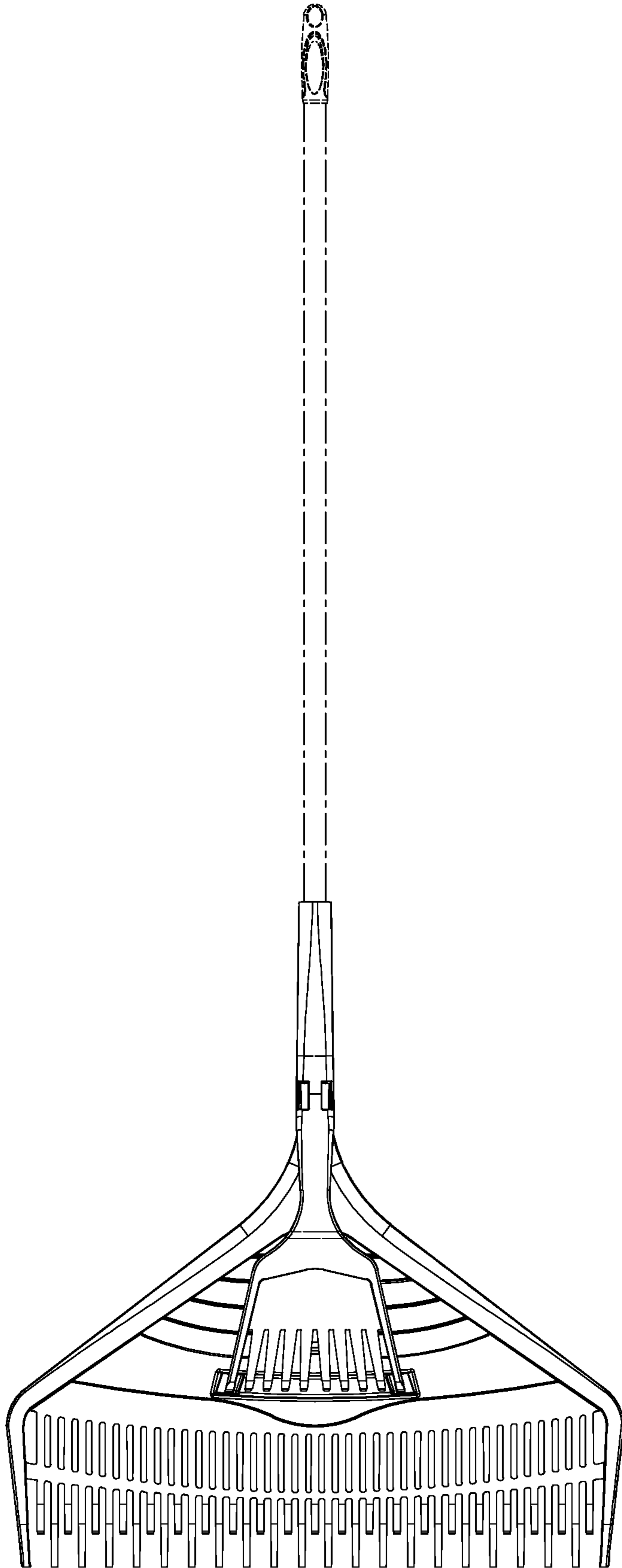

Fig. 15

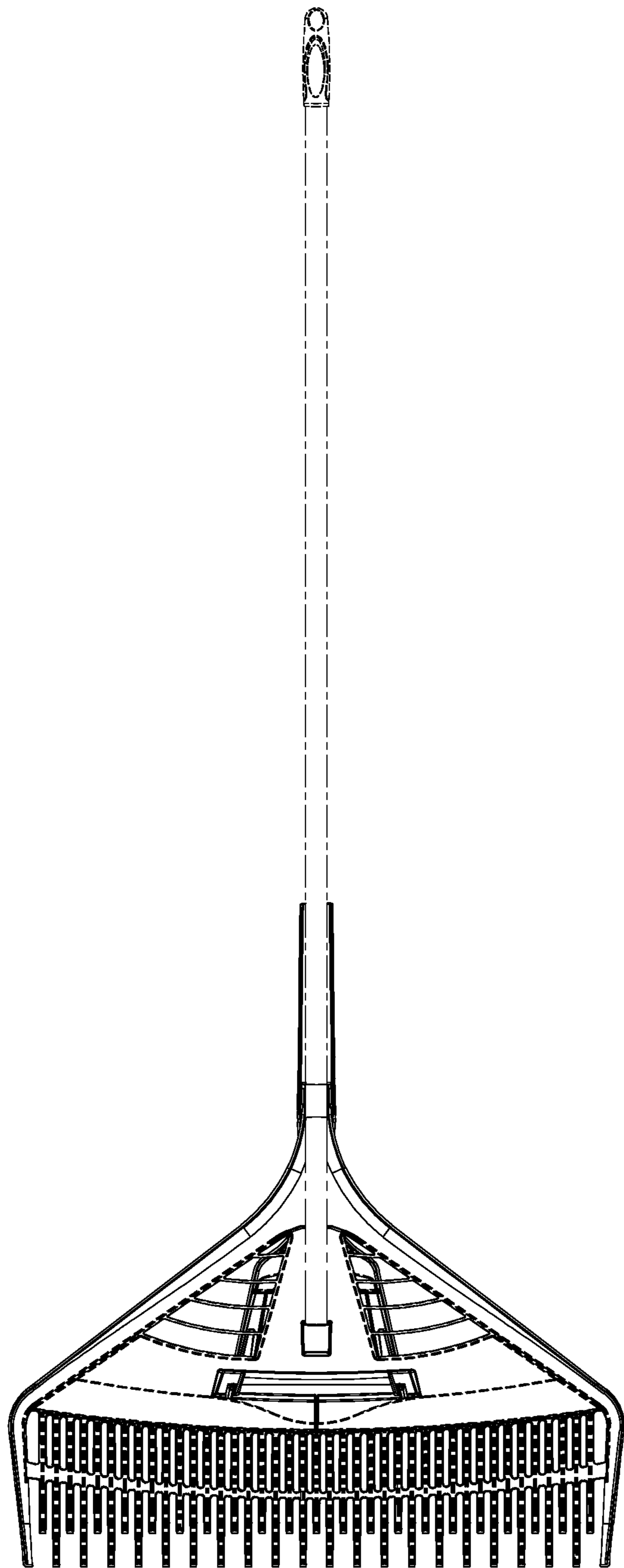

Fig. 16

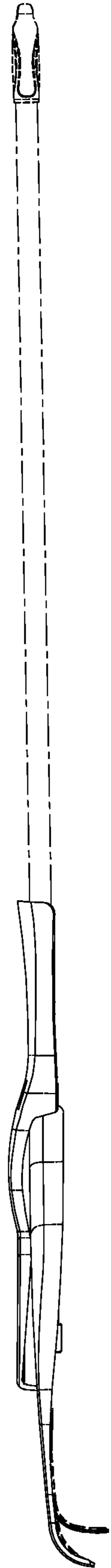

Fig. 17

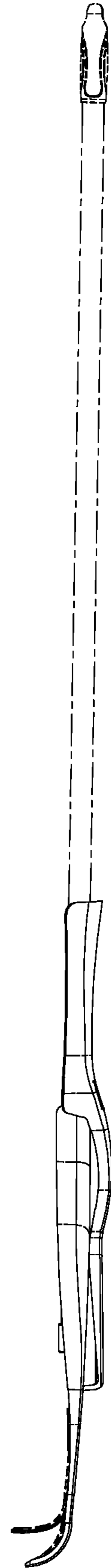

Fig. 18