



US00D982363S

(12) **United States Design Patent** (10) **Patent No.:** **US D982,363 S**  
**Rozier** (45) **Date of Patent:** **\*\* Apr. 4, 2023**

(54) **LOW PROFILE BOOKCASE**  
(71) Applicant: **Charles Rozier**, Longboat Key, FL (US)  
(72) Inventor: **Charles Rozier**, Longboat Key, FL (US)  
(\*\*) Term: **15 Years**  
(21) Appl. No.: **29/767,154**  
(22) Filed: **Jan. 20, 2021**  
(51) **LOC (14) Cl.** ..... **06-06**  
(52) **U.S. Cl.**  
USPC ..... **D6/675.1**  
(58) **Field of Classification Search**  
USPC ..... D6/672, 675, 675.1, 682, 682.1, 682.2, D6/705  
CPC ..... A47B 47/00; A47B 47/04; A47B 63/00; A47B 65/00; A47B 96/00; A47F 5/00; A47F 7/00; A47F 7/0042  
See application file for complete search history.

D521,776 S \* 5/2006 Moyle ..... D6/675.1  
D529,314 S \* 10/2006 Tako ..... D6/675  
D534,379 S \* 1/2007 Juneau ..... D6/691.8  
D542,059 S \* 5/2007 Moyle ..... D6/678.1  
D547,297 S \* 7/2007 Nakamura ..... D6/705.6  
D559,584 S \* 1/2008 Zambelli ..... D6/657  
D559,585 S \* 1/2008 Lara ..... D6/657  
D571,779 S \* 6/2008 Matsuoka ..... D6/675.1  
D615,776 S \* 5/2010 Bauchet ..... D6/675  
D690,142 S \* 9/2013 Arko ..... D6/681  
D848,767 S \* 5/2019 Smrstick ..... D6/657  
D904,080 S \* 12/2020 Curthelet ..... D6/671  
D922,106 S \* 6/2021 Li ..... D6/657  
D933,143 S \* 10/2021 Saragoni ..... D21/690  
D956,454 S \* 7/2022 Smith ..... D6/672  
2008/0223738 A1 9/2008 Voss

\* cited by examiner

*Primary Examiner* — Kelley A Donnelly  
(74) *Attorney, Agent, or Firm* — LaMorte & Associates P.C.

(57) **CLAIM**

The ornamental design for a low profile bookcase, as shown and described.

(56) **References Cited**

U.S. PATENT DOCUMENTS

641,459 A 1/1900 Macey  
863,286 A 8/1907 Kershaw  
D175,914 S \* 10/1955 Schild ..... D6/673  
D178,783 S 9/1956 King  
D213,323 S \* 2/1969 Buccino et al. .... D6/675  
4,322,118 A 3/1982 Shugart  
5,127,717 A 7/1992 Martinez  
D330,128 S \* 10/1992 Dzierwa ..... D6/675.1  
D354,255 S \* 1/1995 Devillez ..... D11/158

**DESCRIPTION**

FIG. 1 is a front view of a low profile bookcase;  
FIG. 2 is a rear view thereof;  
FIG. 3 is a top view thereof;  
FIG. 4 is a bottom view thereof;  
FIG. 5 is a right-side view thereof;  
FIG. 6 is a left-side view thereof; and,  
FIG. 7 is a perspective view thereof.

**1 Claim, 6 Drawing Sheets**

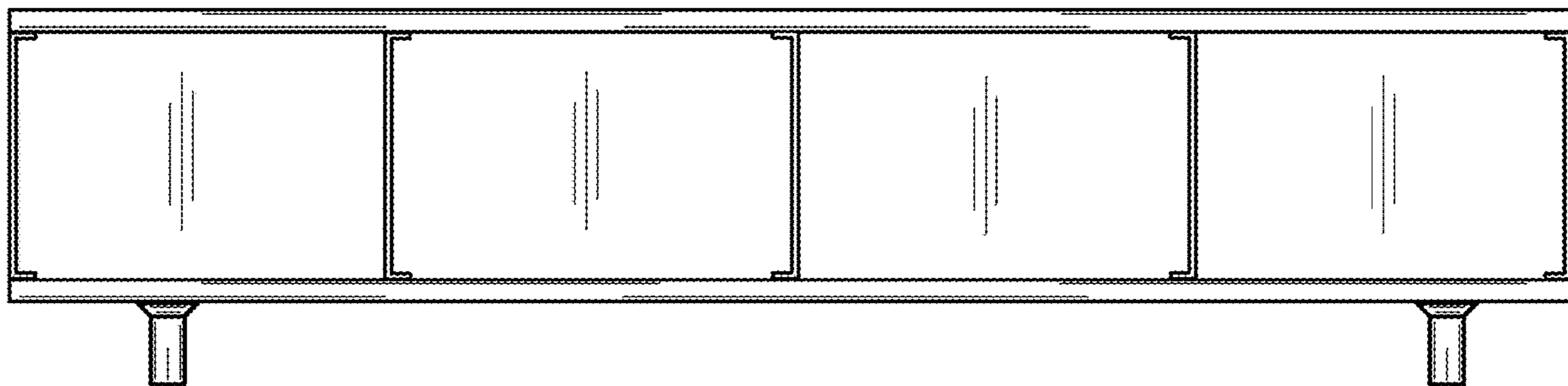

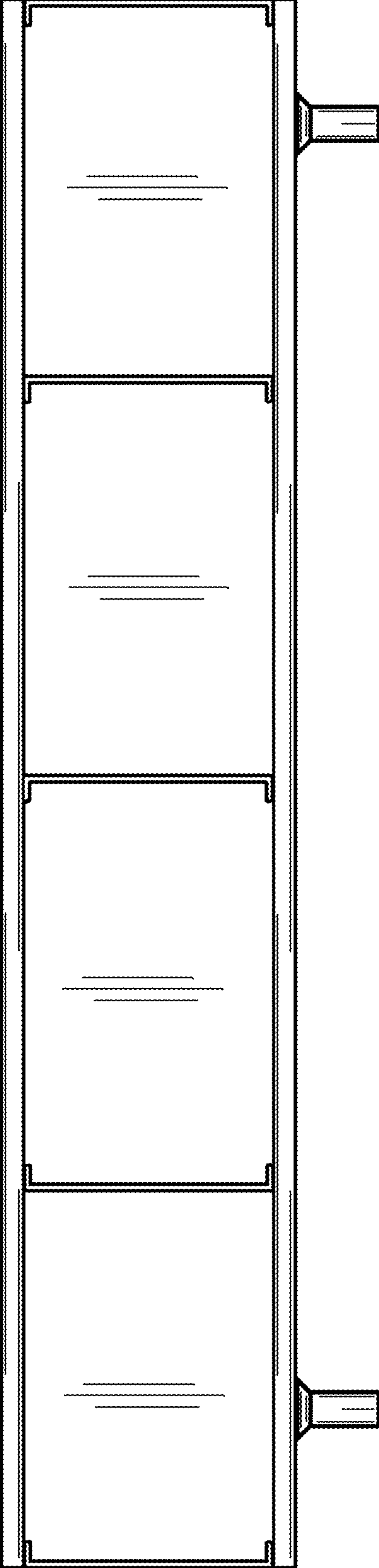

*FIG. 1*

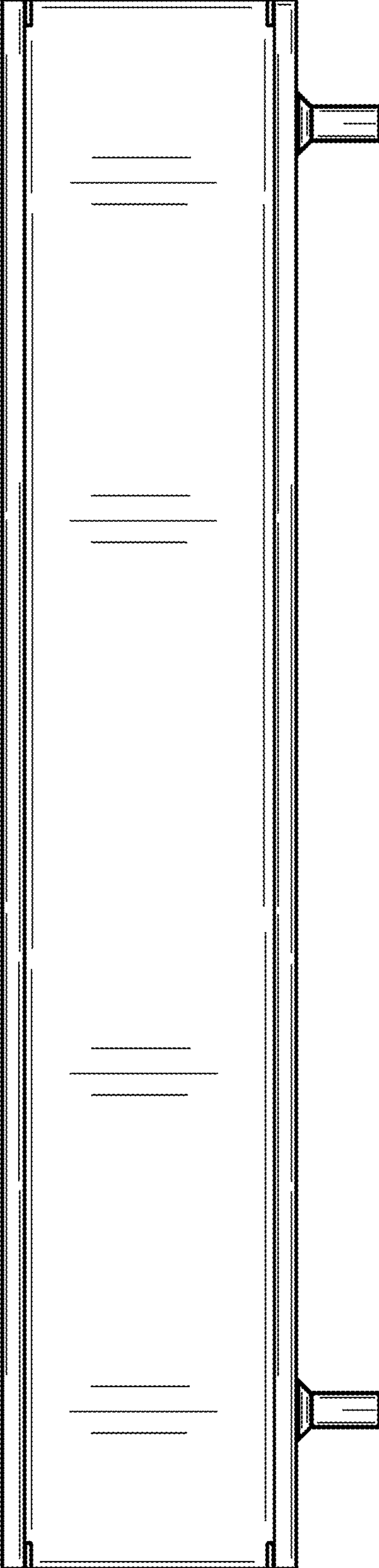
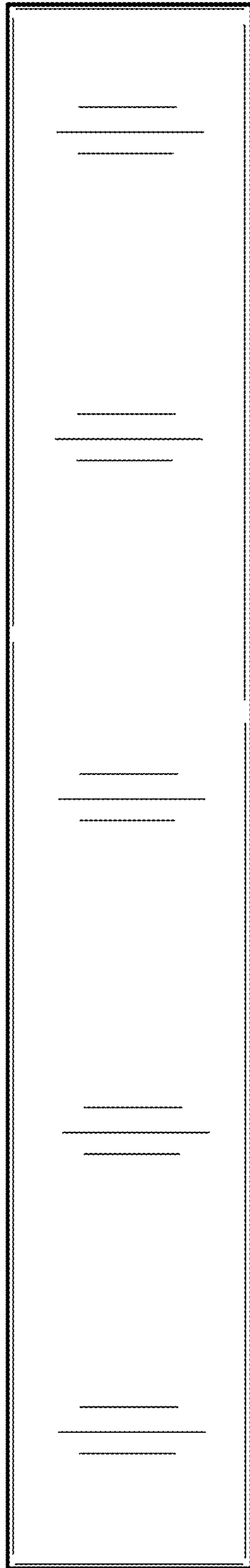
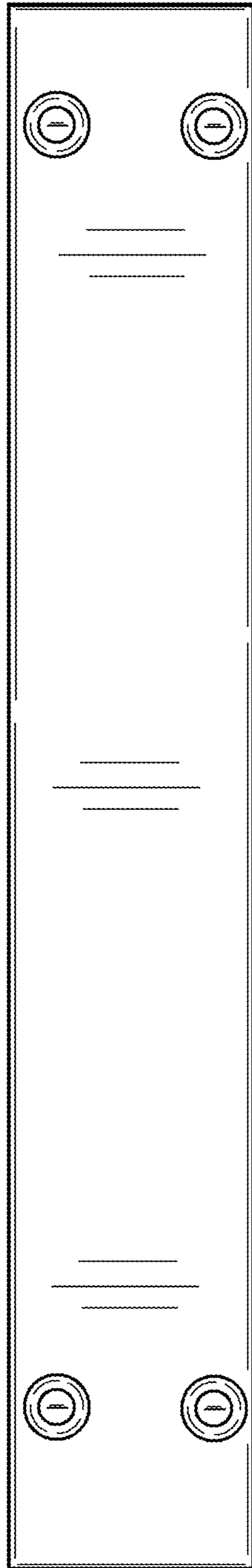

FIG. 2



*FIG. 3*



*FIG. 4*

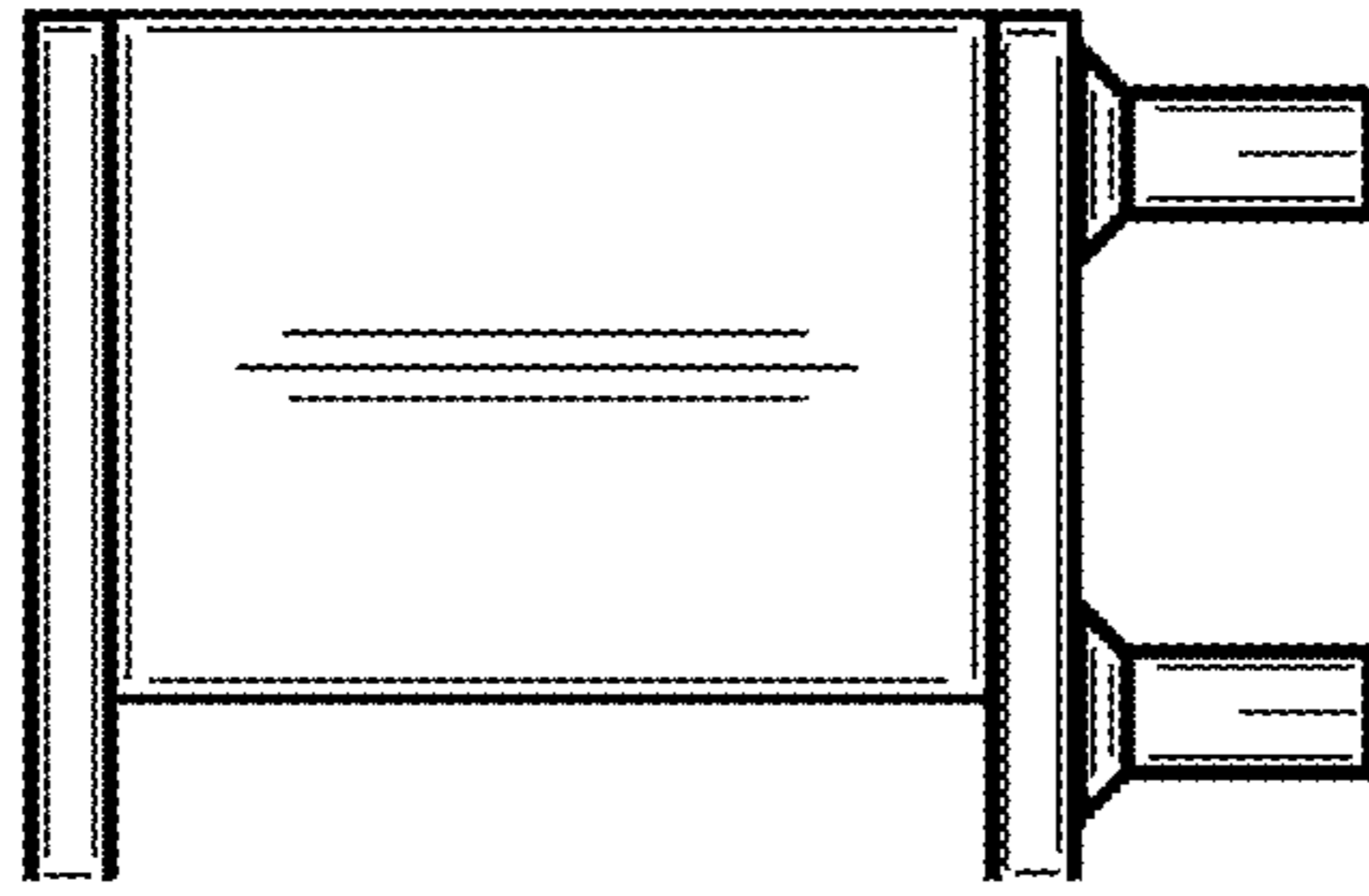

*FIG. 6*

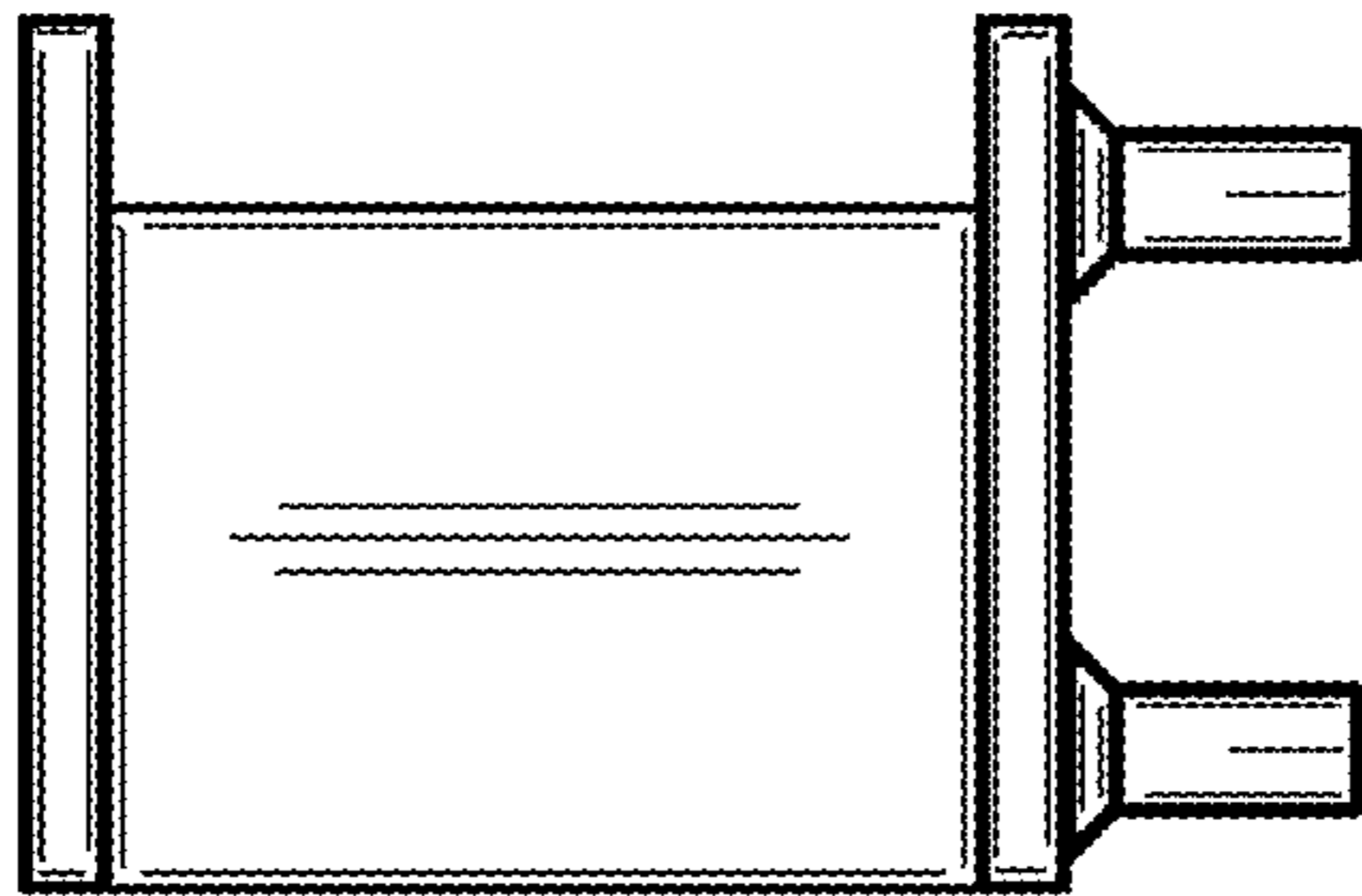

*FIG. 5*

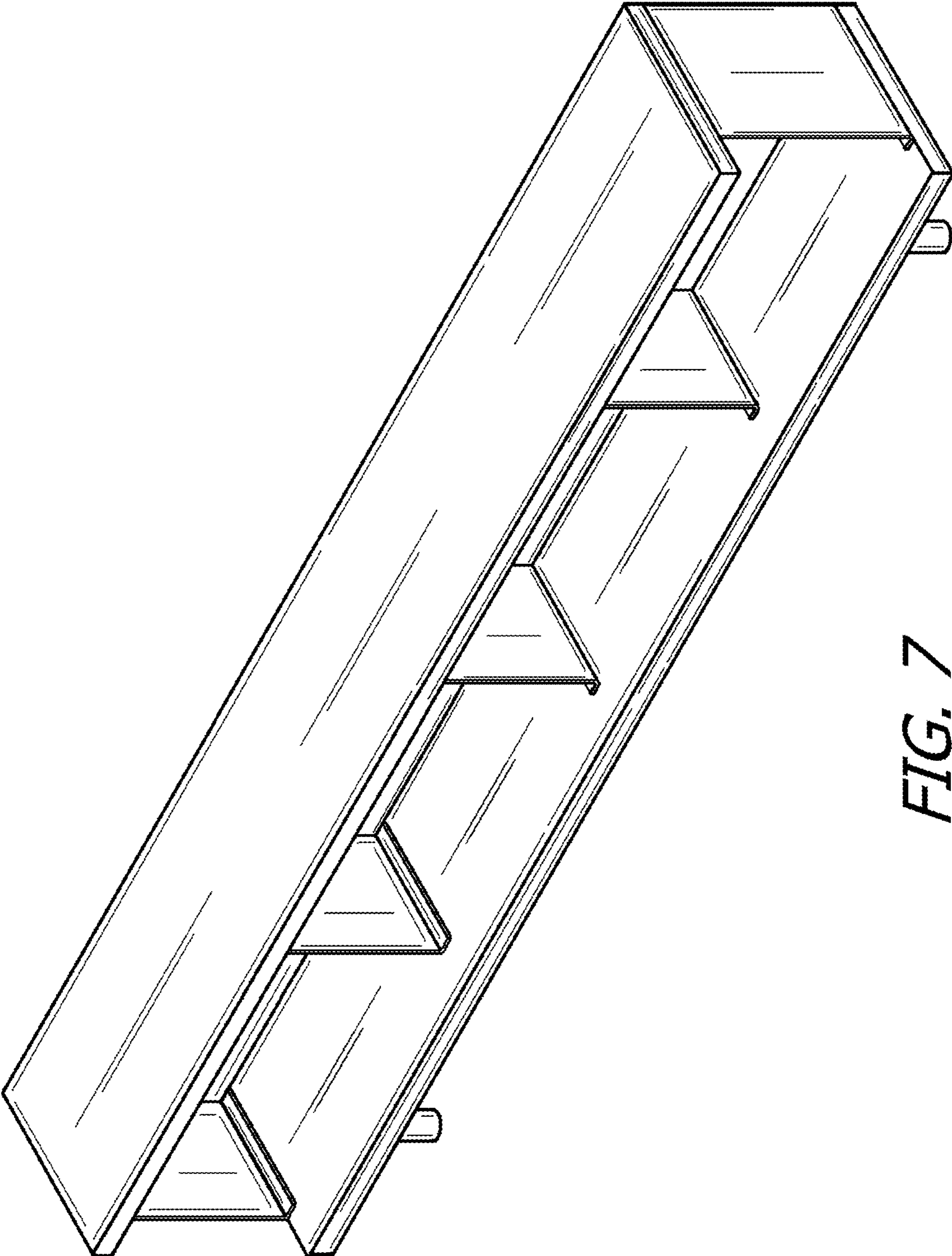

*FIG. 7*