



US00D982355S

(12) **United States Design Patent**
Chen

(10) **Patent No.:** **US D982,355 S**

(45) **Date of Patent:** **** Apr. 4, 2023**

(54) **PILLOW**

(71) Applicant: **Xiaocheng Chen**, Shenzhen (CN)

(72) Inventor: **Xiaocheng Chen**, Shenzhen (CN)

(**) Term: **15 Years**

(21) Appl. No.: **29/809,799**

(22) Filed: **Sep. 30, 2021**

(51) **LOC (14) Cl.** **06-09**

(52) **U.S. Cl.**
USPC **D6/601**

(58) **Field of Classification Search**
USPC D6/595, 596, 597, 601, 604
CPC A47C 19/00; A47C 23/00; A47C 21/026;
A47C 27/00; A47C 27/06; A47C 27/08;
A47C 27/081; A47C 27/082; A47G 9/10;
A47G 9/1009; A47G 9/1027; A47G
9/1045; A47G 9/1063; A47G 9/1072;
A47G 9/1081

See application file for complete search history.

(56) **References Cited**

U.S. PATENT DOCUMENTS

D465,686 S *	11/2002	Hwong	D6/601
D668,092 S *	10/2012	Davis	D6/601
9,009,897 B2 *	4/2015	Davis	A61G 7/072 5/636
D759,991 S *	6/2016	Jing	D6/601
D839,026 S *	1/2019	Huang	D6/601
D856,028 S *	8/2019	Zou	D6/601
D856,707 S *	8/2019	Wilt	D6/601
D867,021 S *	11/2019	Yang	D6/601
D869,196 S *	12/2019	Shin	D6/601
D871,109 S *	12/2019	Haw	D6/601
D874,186 S *	2/2020	Mi	D6/601
D880,195 S *	4/2020	Yang	D6/601
D881,603 S *	4/2020	Yang	D6/601
D881,608 S *	4/2020	Fu	D6/601
D885,085 S *	5/2020	Dowd	D6/601
D898,429 S *	10/2020	Huang	D6/601

D898,439 S *	10/2020	Luo	D6/601
D898,447 S *	10/2020	Xu	D6/601
D903,377 S *	12/2020	Yin	D6/601
D906,726 S *	1/2021	Hagglund	D6/596
D907,940 S *	1/2021	Kassin	D6/596

(Continued)

FOREIGN PATENT DOCUMENTS

CN	306253653	*	12/2020
CN	306429006	*	4/2021

(Continued)

OTHER PUBLICATIONS

Emircey Adjustable Neck Pillow,earliest pictured review Jul. 12, 2022, [online], [site visited Nov. 19, 2022]. Available from Internet, <URL: https://www.amazon.com/Emircey-Adjustable-Sleeping-Ergonomic-Orthopedic/dp/B09ZPKCM61/ref=sr_1_58?keywords=neck+pillow&qid=1668912248&srefix=neck+%2Caps%2C347&sr=8-58> (Year: 2022).*

(Continued)

Primary Examiner — Sanjeev Paul

(74) *Attorney, Agent, or Firm* — Che-Yang Chen; Law Office of Michael Chen

(57) **CLAIM**

The ornamental design for a pillow, as shown and described.

DESCRIPTION

FIG. 1 is a perspective view of the pillow showing my new design;
FIG. 2 is a front elevational view thereof;
FIG. 3 is a rear elevational view thereof;
FIG. 4 is a left side elevational view thereof;
FIG. 5 is a right side elevational view thereof;
FIG. 6 is a top plan view thereof; and,
FIG. 7 is a bottom plan view thereof.

1 Claim, 7 Drawing Sheets

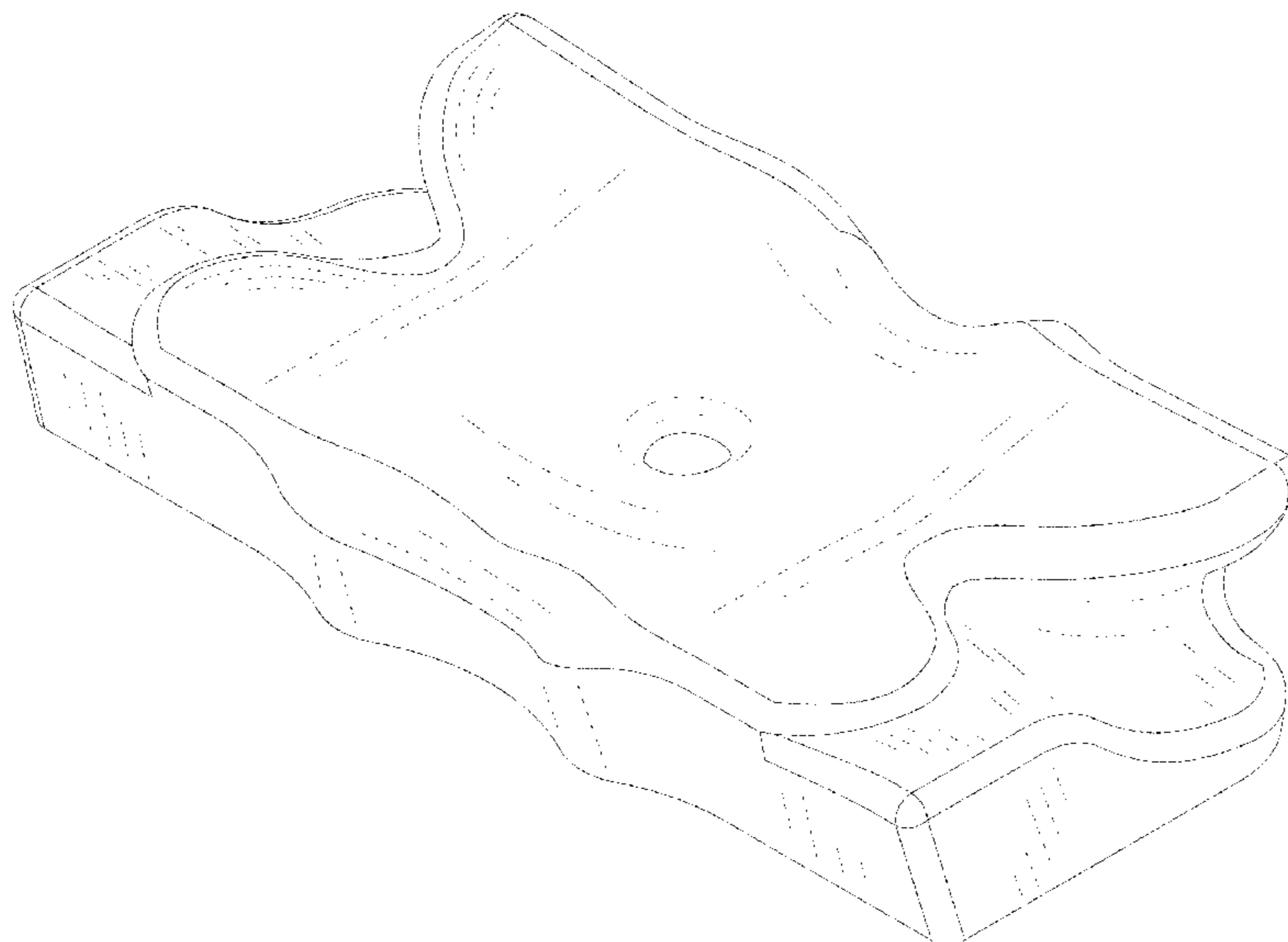

(56)

References Cited

U.S. PATENT DOCUMENTS

D908,394 S * 1/2021 Yin D6/601
 D909,092 S * 2/2021 Pearce D6/601
 D909,790 S * 2/2021 Pearce D6/601
 D909,791 S * 2/2021 Wang D6/601
 D911,071 S * 2/2021 Yu D6/601
 D911,074 S * 2/2021 He D6/604
 D912,438 S * 3/2021 Butler D6/604
 D912,439 S * 3/2021 Ou D6/604
 D913,013 S * 3/2021 Rensin D6/601
 D915,104 S * 4/2021 Yang D6/601
 D925,948 S * 7/2021 Feng D6/601
 D927,225 S * 8/2021 Wang D6/601
 D929,771 S * 9/2021 Wang D6/601
 D930,399 S * 9/2021 Zou D6/601
 D930,400 S * 9/2021 Betham D6/601
 D931,648 S * 9/2021 Higgins D6/601
 D932,803 S * 10/2021 Yang D6/601
 D932,804 S * 10/2021 Yang D6/601
 D934,593 S * 11/2021 Zou D6/601
 D939,248 S * 12/2021 Wang D6/601
 D941,056 S * 1/2022 Zou D6/601
 D941,057 S * 1/2022 Zou D6/601
 D941,610 S * 1/2022 Zhang D6/601
 D944,033 S * 2/2022 Yang D6/601
 D944,036 S * 2/2022 Mi D6/601
 D944,037 S * 2/2022 Yang D6/601
 D944,566 S * 3/2022 Yang D6/601
 D949,603 S * 4/2022 Ouyang D6/601
 D957,848 S * 7/2022 Liu D6/601
 D957,849 S * 7/2022 Li D6/601

D959,875 S * 8/2022 Zhang D6/601
 D959,876 S * 8/2022 Zhang D6/601
 D961,297 S * 8/2022 Liu D6/601
 D965,345 S * 10/2022 Xia D6/601
 D965,346 S * 10/2022 Xia D6/601
 D969,519 S * 11/2022 Goserud D6/601
 2017/0156958 A1 * 6/2017 Roh A47G 9/109
 2022/0000289 A1 * 1/2022 Ho A47G 9/109

FOREIGN PATENT DOCUMENTS

CN 306474371 * 4/2021
 CN 306592526 * 6/2021
 KR 301173186.0000 * 7/2022

OTHER PUBLICATIONS

Google Term Search: 'cervical pillow', [site visited Nov. 19, 2022]
 <URL: https://www.google.com/search?q=cervical+pillow&sxsrf=ALiCzsbqVnadsXEro1pREWsw3B46A15kvA:1668912007163&source=lnms&tbm=isch&sa=X&ved=2ahUKEwiZnOTa3bv7AhXqD1kFHcl2CdsQ_AUoAnoECAIQBA&biw=1902&bih=984&dpr=1> (Year: 2022).*

Google Term Search: 'neck support pillow', [site visited Nov. 19, 2022]
 <URL: https://www.google.com/search?q=neck+support+pillow&sxsrf=ALiCzsaxc8HbNj9KFfi1WSckBuGtK7z_AA:1668912095773&source=lnms&tbm=isch&sa=X&ved=2ahUKEwjdxYSF3rv7AhW9LFkFHU0cBN0Q_AUoAnoECAIQBA&biw=1902&bih=984&dpr=1> (Year: 2022).*

* cited by examiner

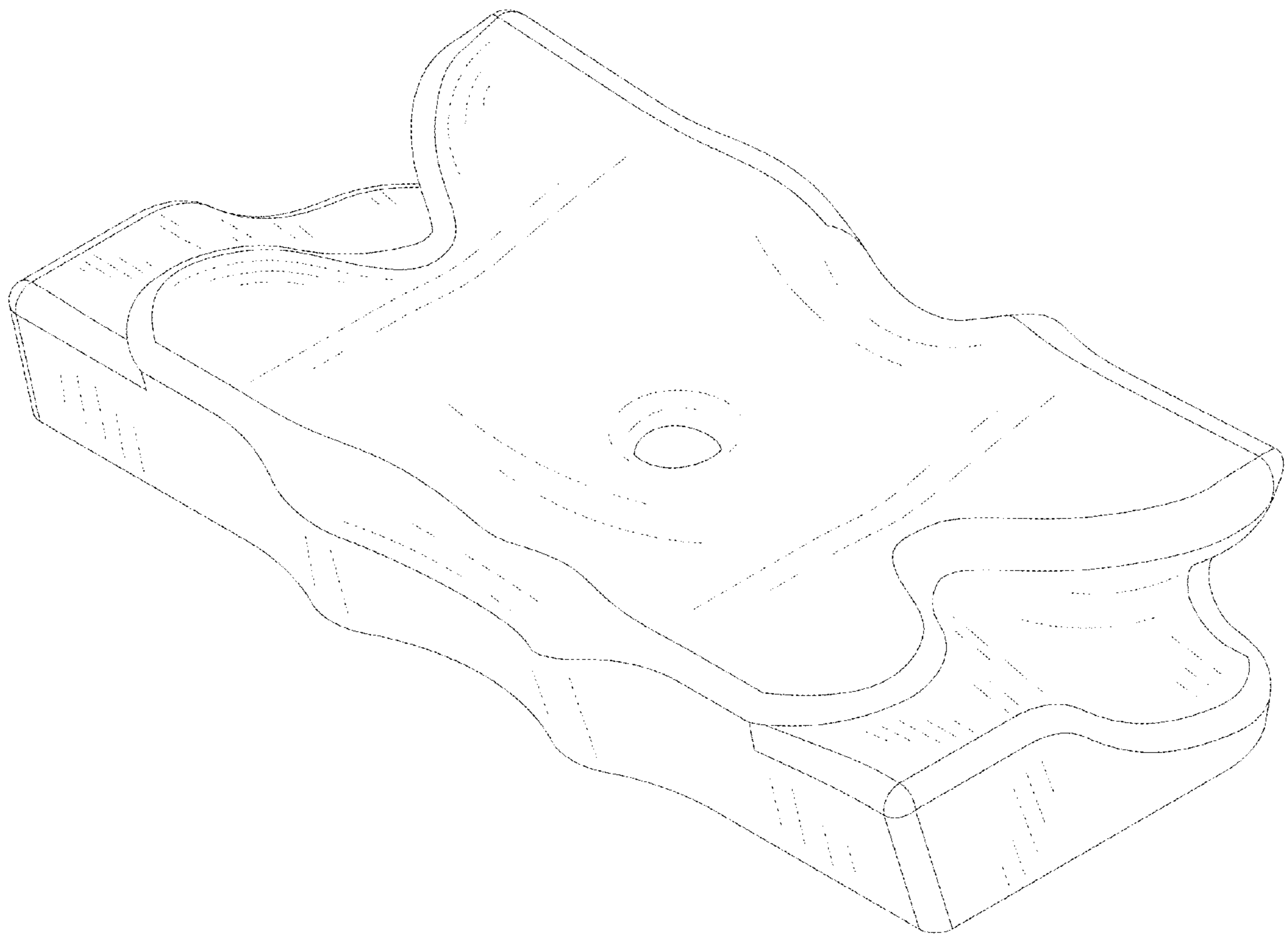

FIG.1

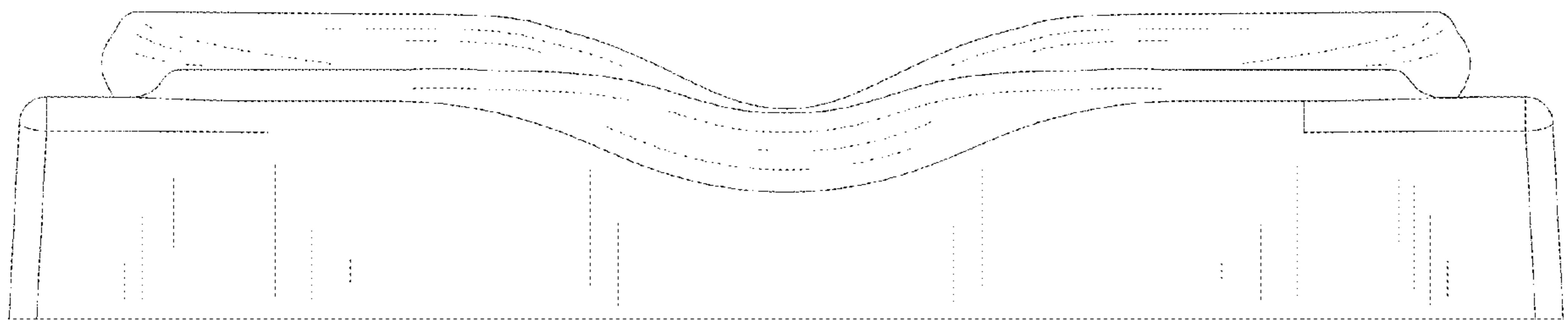

FIG.2

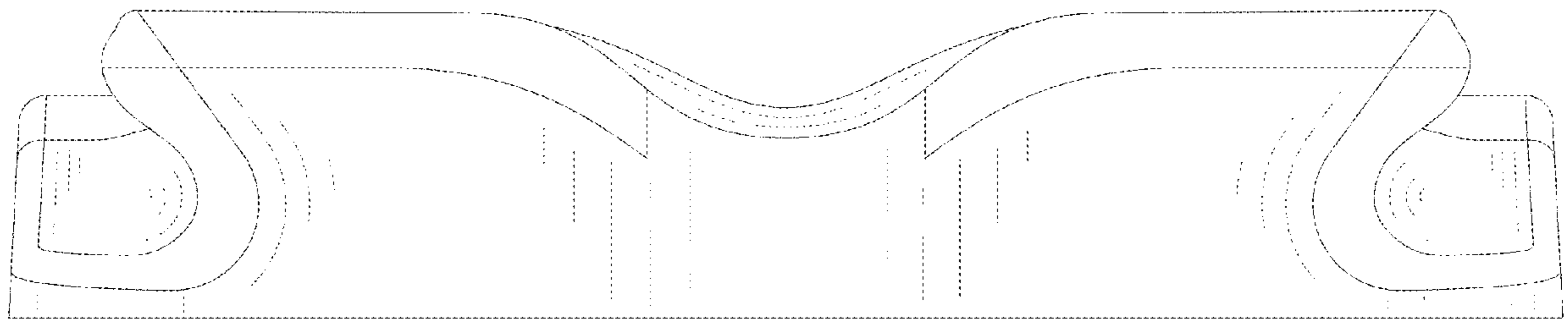

FIG. 3

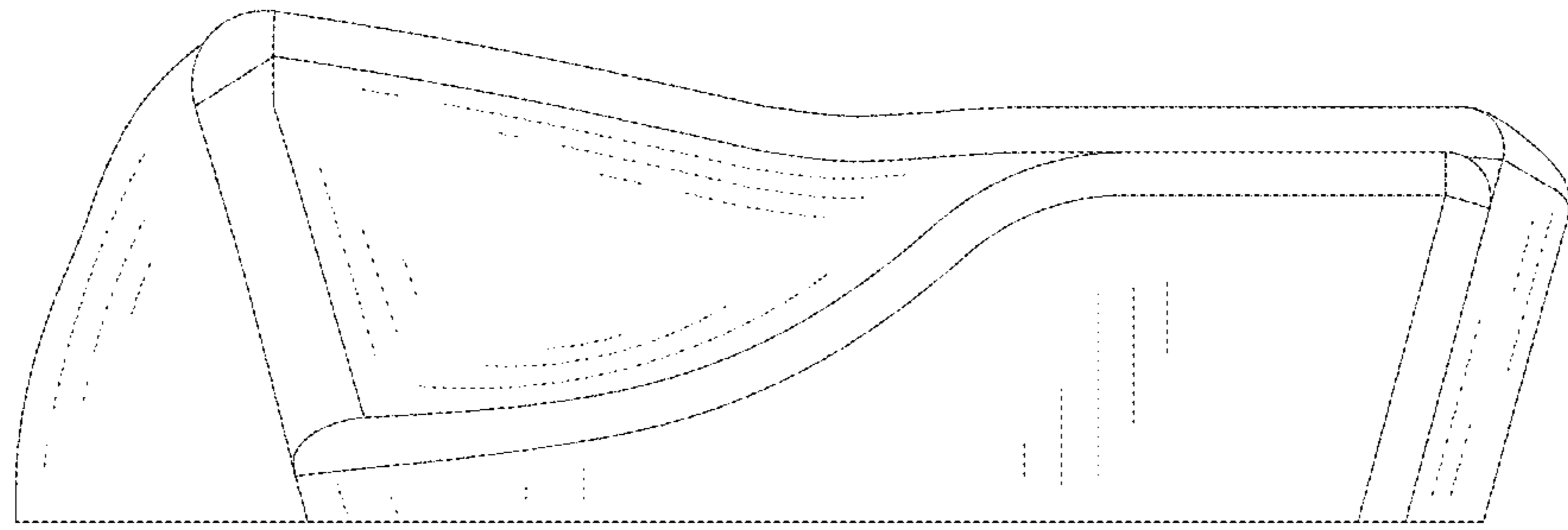

FIG. 4

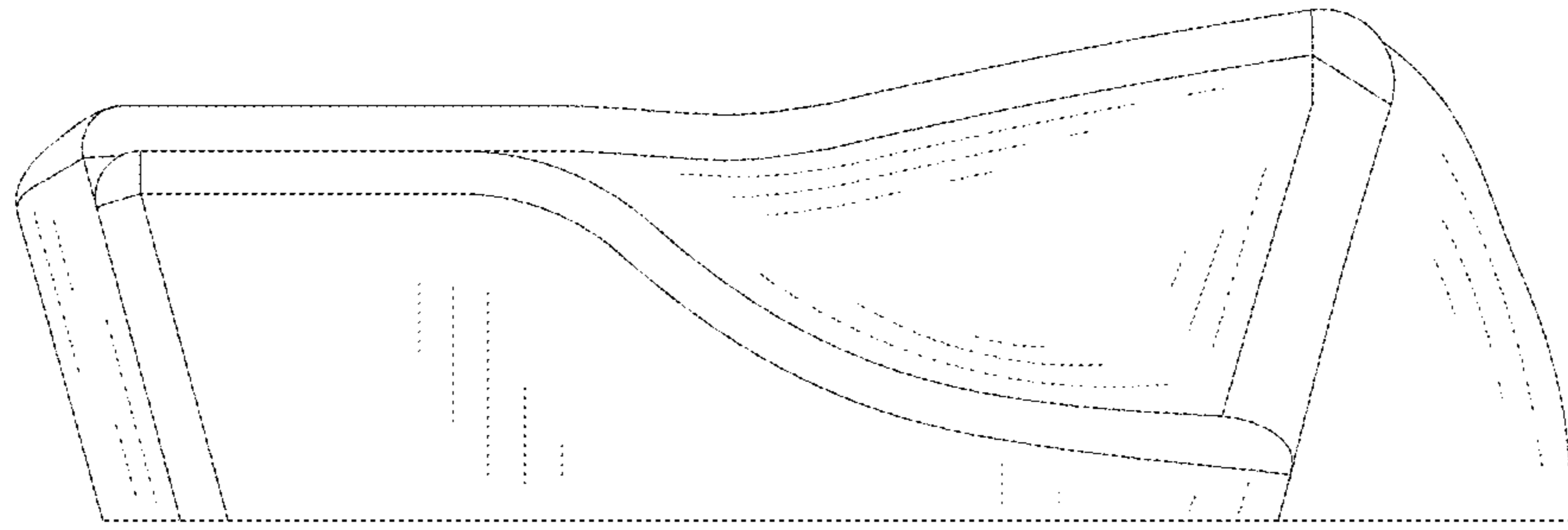

FIG. 5

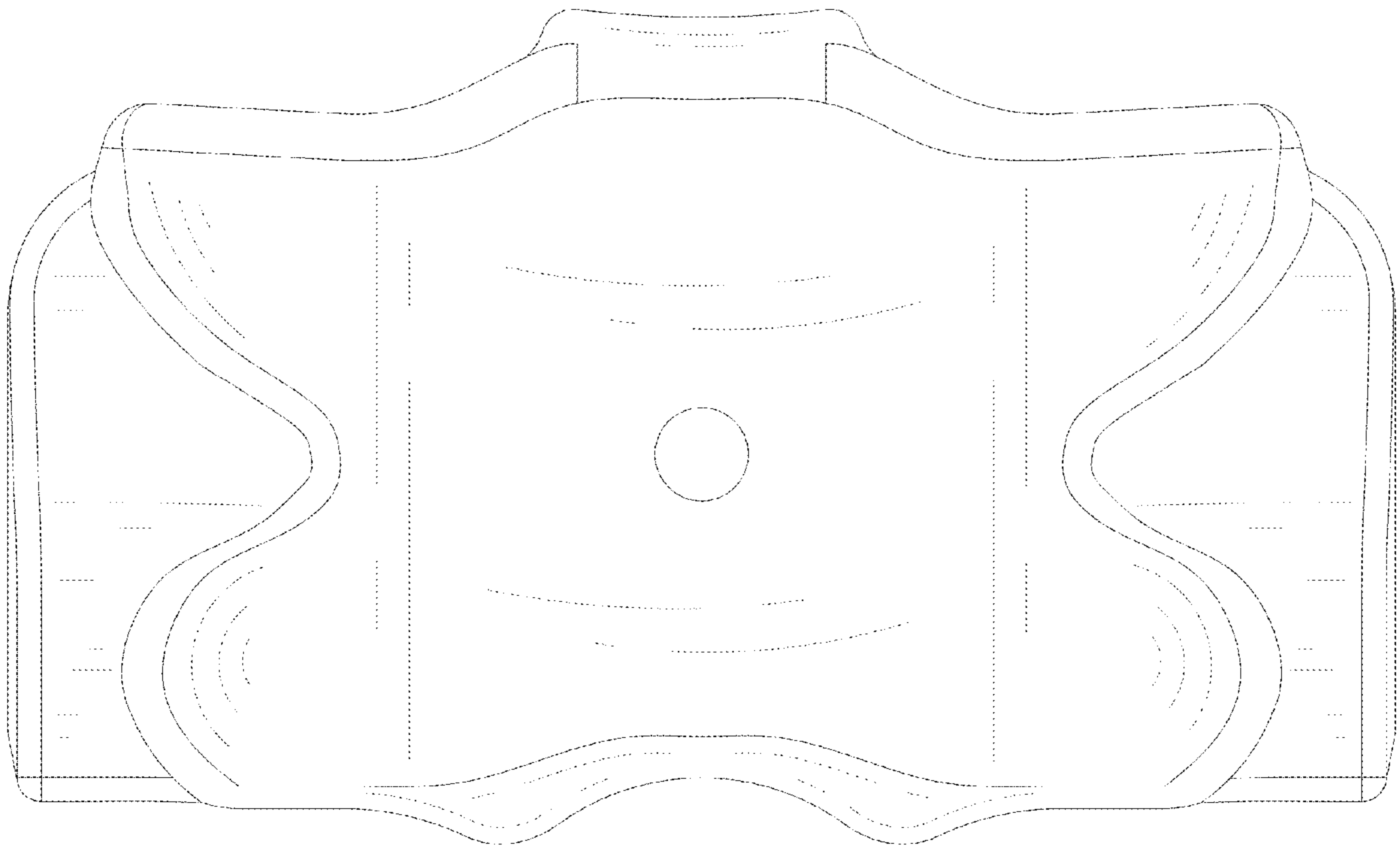

FIG. 6

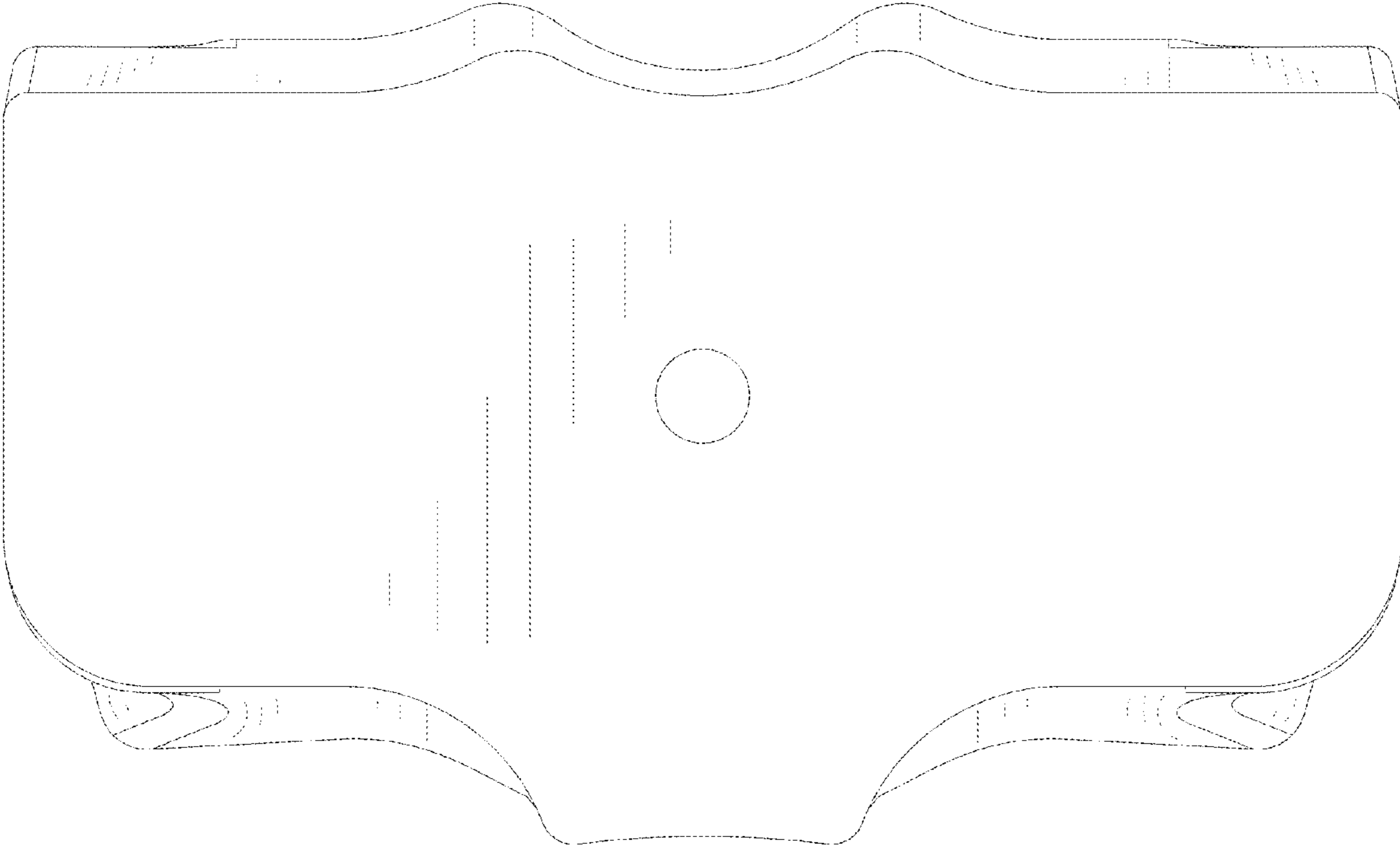

FIG. 7