



US00D982349S

(12) **United States Design Patent** (10) **Patent No.:** **US D982,349 S**
Nathan et al. (45) **Date of Patent:** **** Apr. 4, 2023**

- (54) **BAKEWARE STORAGE SYSTEM**
- (71) Applicant: **Caraway Home, Inc.**, New York, NY (US)
- (72) Inventors: **Jordan Nathan**, New York, NY (US); **Bret Recor**, San Francisco, CA (US); **Benjamin Gross**, San Francisco, CA (US); **Kenneth Young**, San Francisco, CA (US); **Christoph Andrejic**, San Francisco, CA (US)
- (73) Assignee: **Caraway Home, Inc.**, New York, NY (US)
- (**) Term: **15 Years**
- (21) Appl. No.: **29/782,560**
- (22) Filed: **May 7, 2021**
- (51) **LOC (14) Cl.** **08-08**
- (52) **U.S. Cl.**
USPC **D6/567**
- (58) **Field of Classification Search**
USPC D6/567; D8/71; D3/201, 304, 313
CPC A47J 47/16; B65D 25/04; B65D 25/2808; A47B 77/18
See application file for complete search history.

D972,893 S * 12/2022 Worden, IV D6/706
 D975,467 S * 1/2023 Kraemer D3/304
 2021/0100403 A1 * 4/2021 Nathan A47B 81/04
 2022/0402653 A1 * 12/2022 Nathan A47J 47/16

FOREIGN PATENT DOCUMENTS

CN 306397042 * 3/2021
 EM 008747372-0001 * 11/2021

(Continued)

OTHER PUBLICATIONS

Caraway Bakeware Set, posted unknown [online], [retrieved Jan. 19, 2023]. Retrieved from internet, <https://www.carawayhome.com/products/11pc-bakeware-set/> (Year: 2023).*

(Continued)

Primary Examiner — Cynthia Ramirez
Assistant Examiner — Jeremy S. Swartz
 (74) *Attorney, Agent, or Firm* — Bochner IP, PLLC;
 Andrew D. Bochner

(57) **CLAIM**

The ornamental design for a bakeware storage system, as shown and described.

DESCRIPTION

FIG. 1 is a top, front, right side perspective view for a bakeware storage system showing our new design;
 FIG. 2 is a front elevation view thereof;
 FIG. 3 is a rear elevation view thereof;
 FIG. 4 is a left side elevation view thereof;
 FIG. 5 is a right side elevation view thereof;
 FIG. 6 is a top plan view thereof; and,
 FIG. 7 is a bottom plan view thereof.
 In the drawings, the broken lines are for the purpose of illustrating environment only, and form no part of the claimed design.

1 Claim, 4 Drawing Sheets

(56) **References Cited**

U.S. PATENT DOCUMENTS

D393,005 S * 3/1998 Devito D19/86
 D413,749 S * 9/1999 Stravitz D6/567
 D636,198 S * 4/2011 Gibbs D6/567
 D842,607 S * 3/2019 Kraemer D3/307
 D887,712 S * 6/2020 Stevens D3/313
 D939,286 S * 12/2021 Nathan D7/601
 D945,888 S * 3/2022 Dai D9/737
 D959,836 S * 8/2022 Tang D3/313
 D960,579 S * 8/2022 Greenwood D3/304

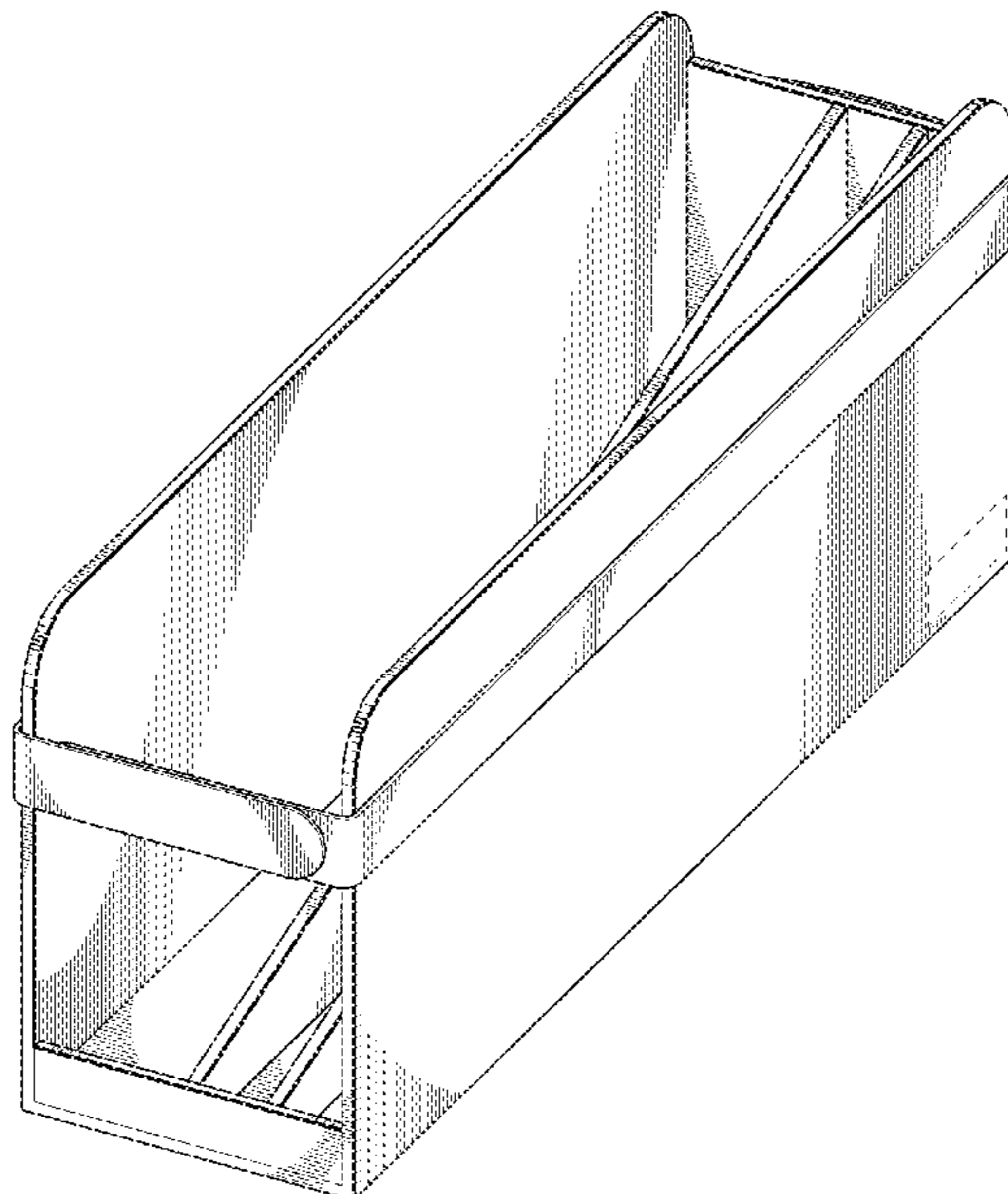

(56)

References Cited

FOREIGN PATENT DOCUMENTS

EM	008749584-0001	* 12/2021
GB	6212736	* 6/2022

OTHER PUBLICATIONS

Caraway Nonstick Ceramic Bakeware Set, posted Apr. 25, 2022 [online], [retrieved Jan. 19, 2023]. Retrieved from internet, <https://www.amazon.com/Caraway-Nonstick-Ceramic-Bakeware-Pieces/dp/B09YT9BYVR?th=1> (Year: 2022).*

SimpleHouseware Over the Cabinet Door Organizer, posted Jan. 22, 2017 [online], [retrieved Jan. 19, 2023]. Retrieved from internet, <https://www.amazon.com/SimpleHouseware-Cabinet-Organizer-Holder-Silver/dp/B01LXKKVPK/?th=1> (Year: 2017).*

Lynk Professional Slide Out Organizer, posted unknown [online], [retrieved Jan. 19, 2023]. Retrieved from internet, <https://www.amazon.com/Lynk-Professional-Bakeware-Organizer-9-6h-inch/dp/B017Y7BLLS> (Year: 2023).*

Hexa Extral Large Refrigerator Bin, posted unknown [online], [retrieved Jan. 19, 2023]. Retrieved from internet, <https://www.bloomingdales.com/shop/product/spectrum-hexa-extra-large-refrigerator-bin?ID=4027835> (Year: 2023).*

Refrigerator Tray, posted unknown [online], [retrieved Jan. 19, 2023]. Retrieved from internet, <https://www.daisojapan.com/p-30447-refrigerator-tray-2-assort-53-118-h35-in-10pks.aspx> (Year: 2023).*

* cited by examiner

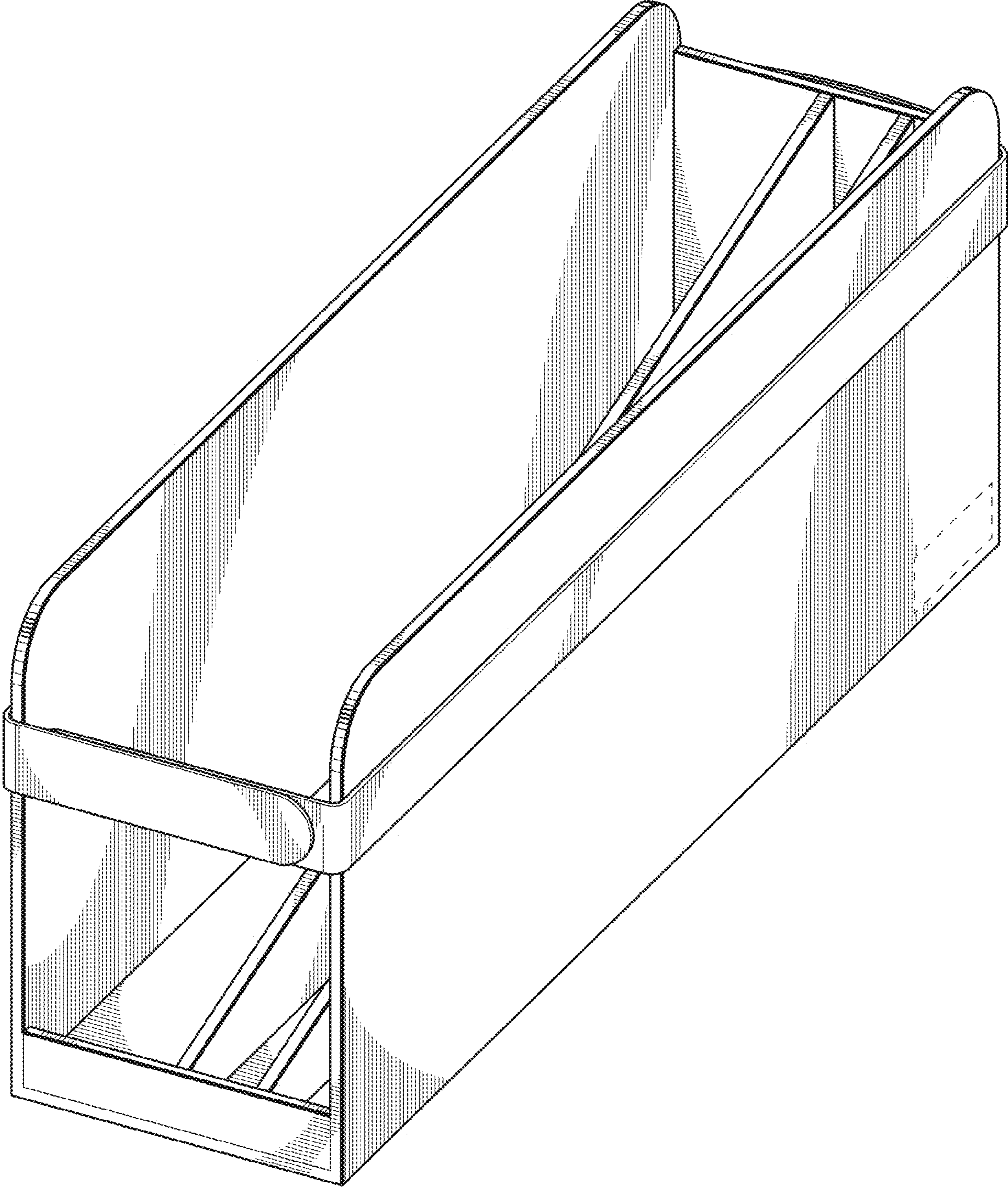

FIG. 1

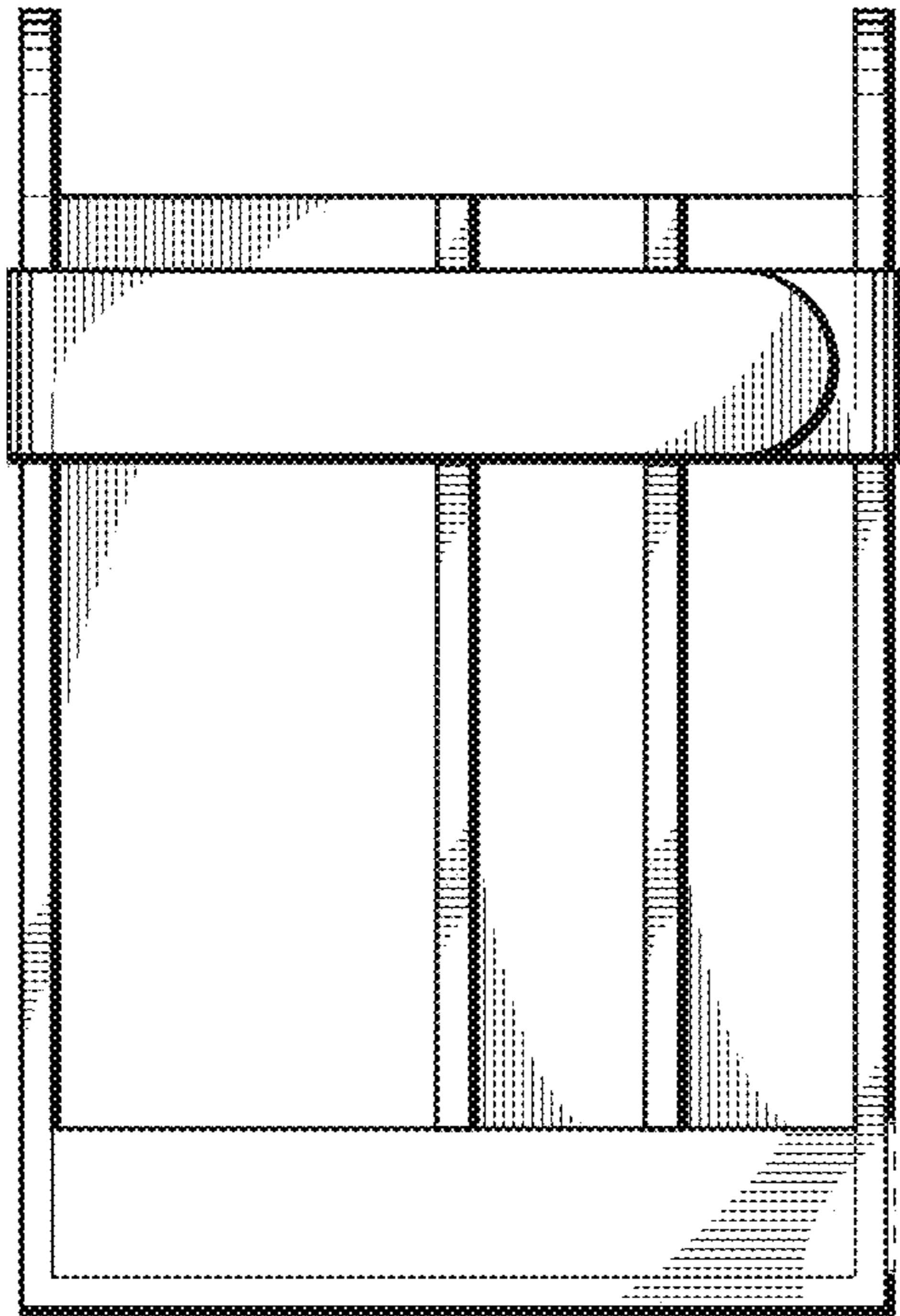

FIG. 2

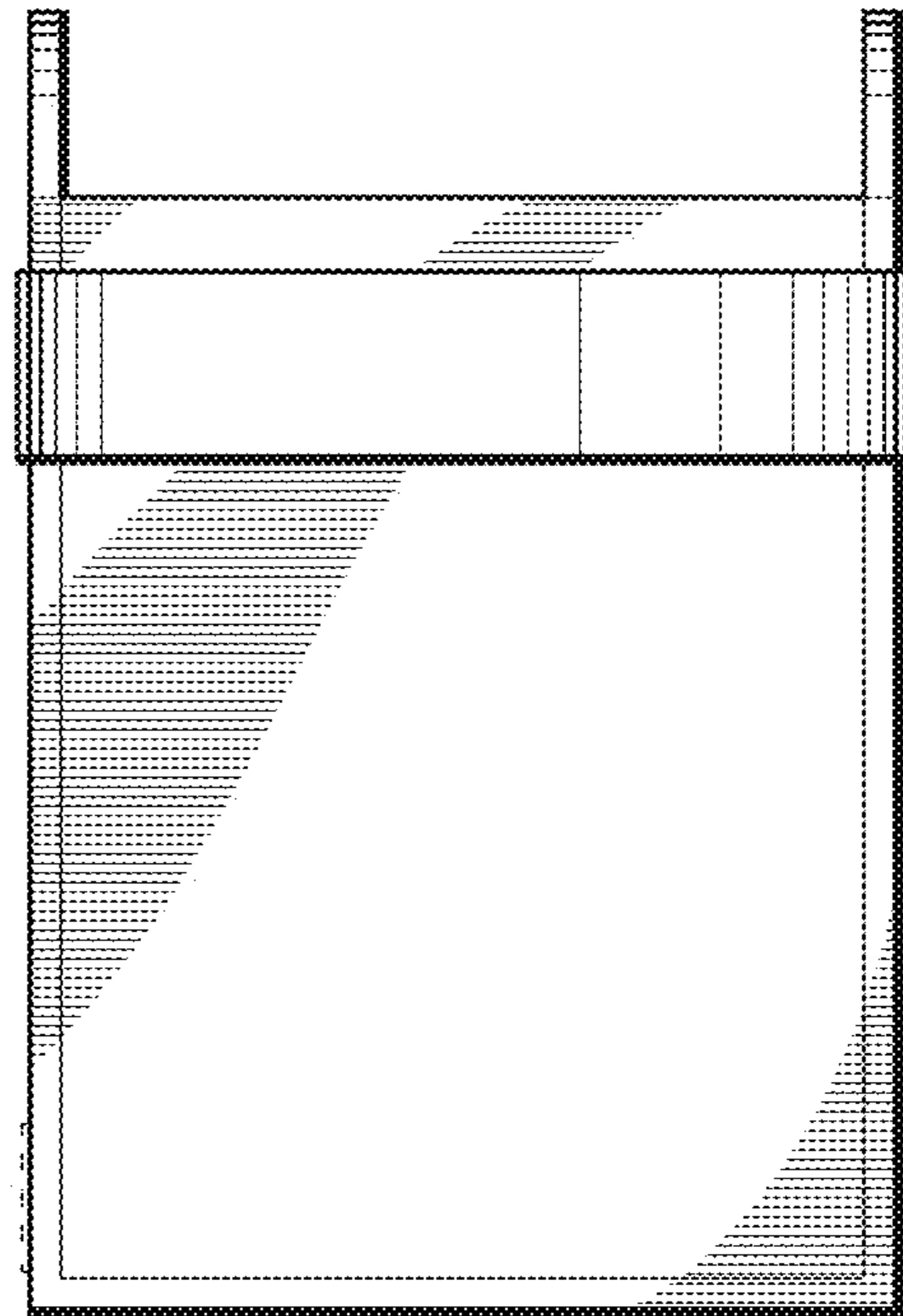

FIG. 3

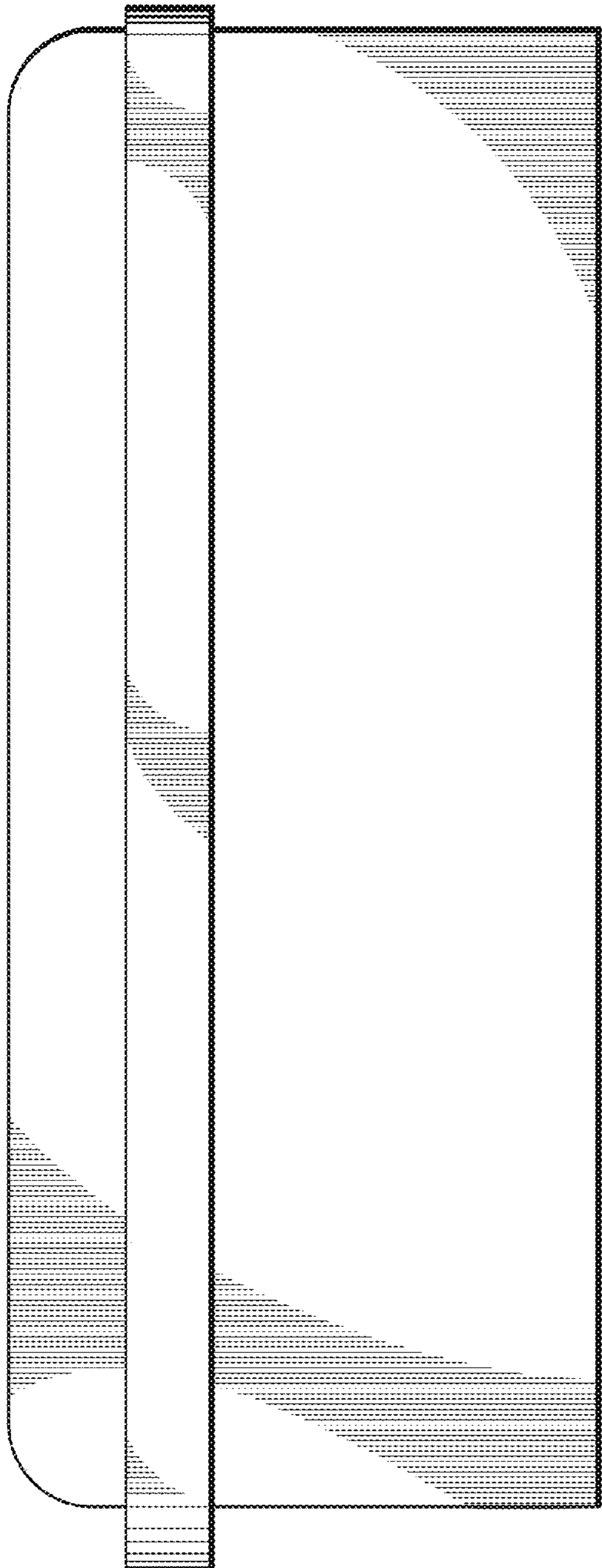

FIG. 4

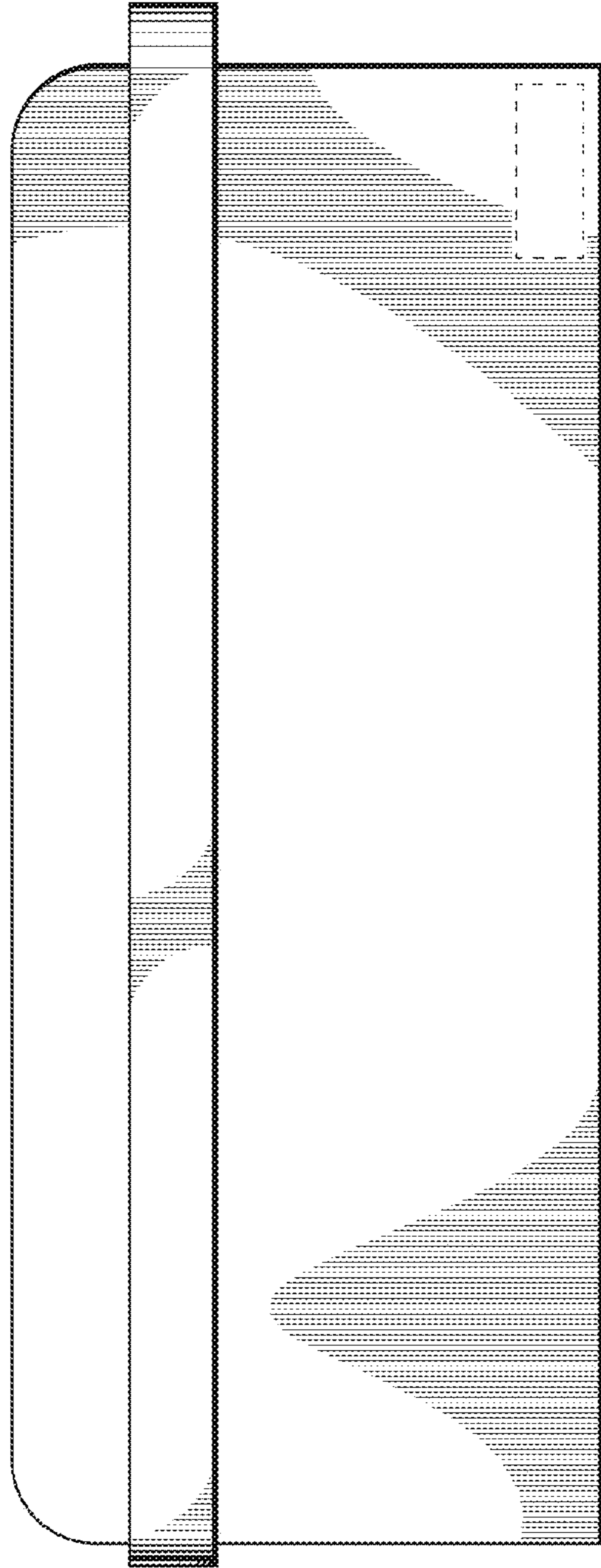

FIG. 5

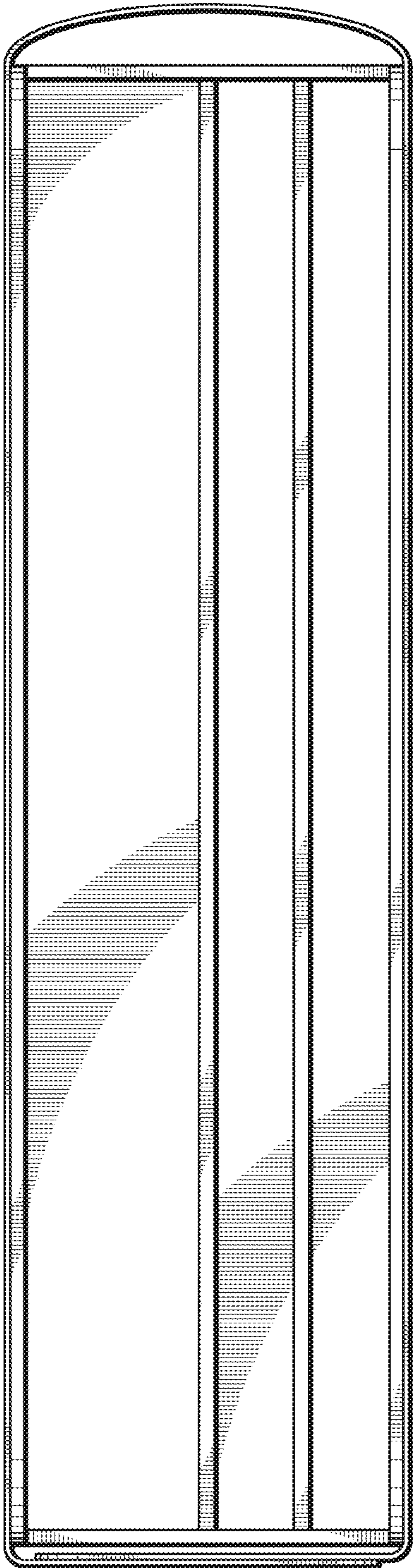

FIG. 6

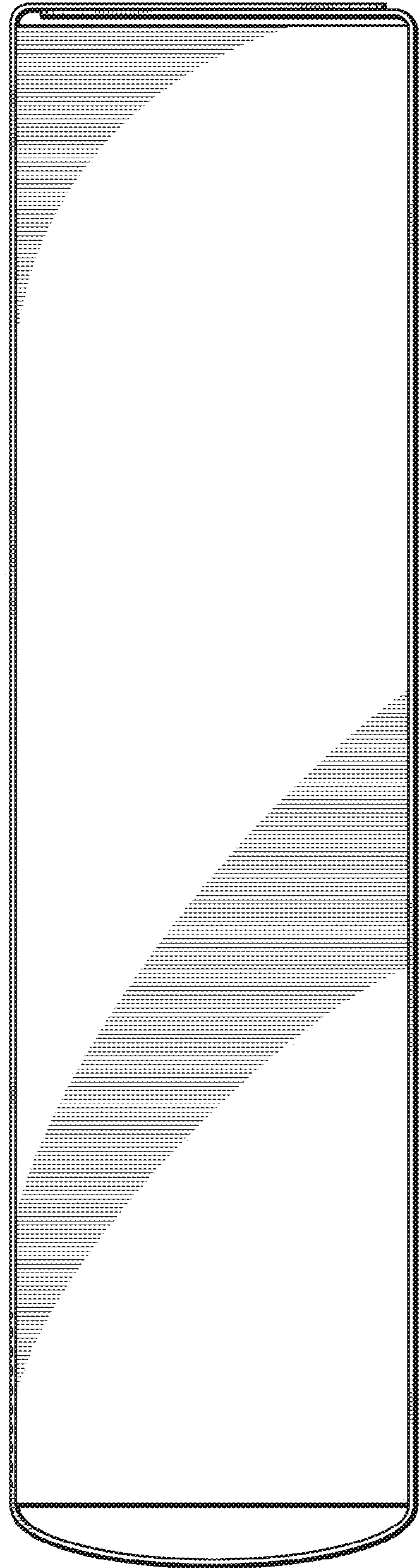

FIG. 7