



US00D982330S

(12) **United States Design Patent**
Milberg et al.

(10) **Patent No.:** **US D982,330 S**
(45) **Date of Patent:** **** Apr. 4, 2023**

(54) **SEATING ELEMENTS OF A MODULAR SEATING FURNITURE**

(74) *Attorney, Agent, or Firm* — Bereskin & Parr LLP/S.E.N.C.R.L., s.r.l.

(71) Applicant: **SOFAWEB.COM INC.**, Concord (CA)

(57) **CLAIM**

(72) Inventors: **Jordan Milberg**, Concord (CA);
Matthew Milberg, Concord (CA)

The ornamental Design for seating elements of a modular seating furniture, as shown and described.

(73) Assignee: **SOFAWEB.COM**, Concord (CA)

DESCRIPTION

(**) Term: **15 Years**

FIG. 1 is a front perspective view of seating elements of a modular seating furniture in accordance with the present design; and

(21) Appl. No.: **29/726,285**

FIG. 2 is an exploded view of the seating elements of a modular seating furniture of FIG. 1;

(22) Filed: **Mar. 2, 2020**

(51) **LOC (14) Cl.** **06-01**

FIG. 3 is a front perspective view of an armrest of the seating elements of a modular seating furniture of FIG. 1;

(52) **U.S. Cl.**

USPC **D6/334; D6/716**

FIG. 4 is a front view of the armrest of FIG. 3;

(58) **Field of Classification Search**

USPC D6/334, 335, 336, 369, 374, 381, 716,
D6/716.1, 716.2

FIG. 5 is a rear view of the armrest of FIG. 3;

CPC A47C 13/005

FIG. 6 is a left side view of the armrest of FIG. 3;

See application file for complete search history.

FIG. 7 is a right side view of the armrest of FIG. 3;

FIG. 8 is a top view of the armrest of FIG. 3;

FIG. 9 is a bottom view of the armrest of FIG. 3; and

FIG. 10 is a front perspective view of a backrest of the seating elements of a modular seating furniture of FIG. 1;

(56) **References Cited**

U.S. PATENT DOCUMENTS

- 3,973,800 A 8/1976 Kogan
- 7,240,967 B2 7/2007 Wade
- D570,129 S * 6/2008 Natuzzi D6/381
- 8,764,114 B1 * 7/2014 Frank A47C 7/42
297/440.16
- D718,552 S * 12/2014 Kanthasamy D6/381
- D811,111 S * 2/2018 Garrison D6/381
- D817,057 S 5/2018 Kohl
- 10,182,659 B2 1/2019 Kuhl et al.

(Continued)

FOREIGN PATENT DOCUMENTS

- BR 202020003238 U2 * 8/2021
- GB 2448083 A * 10/2008 A47C 13/005

Primary Examiner — Deanna L Pratt

1 Claim, 23 Drawing Sheets

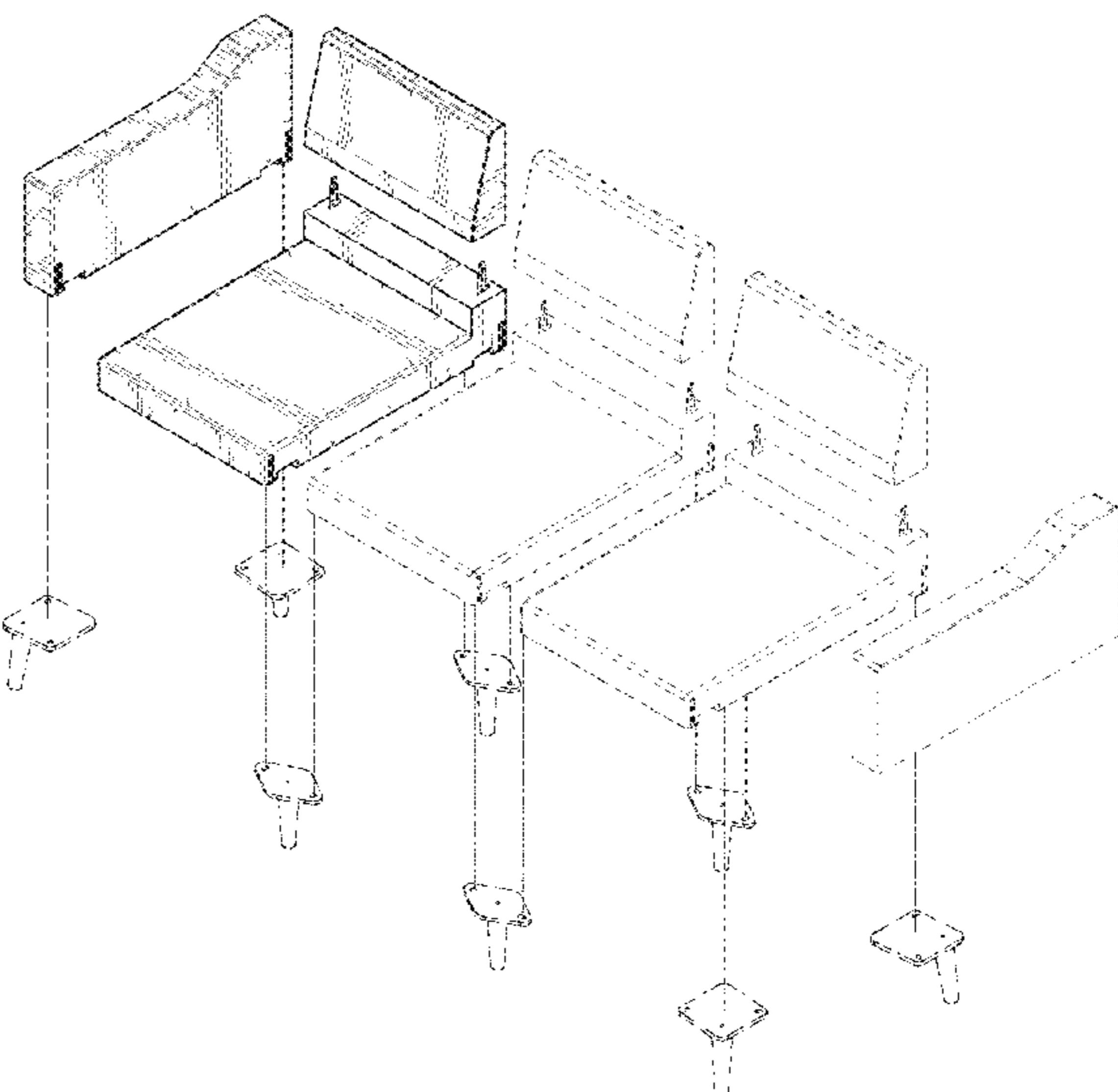
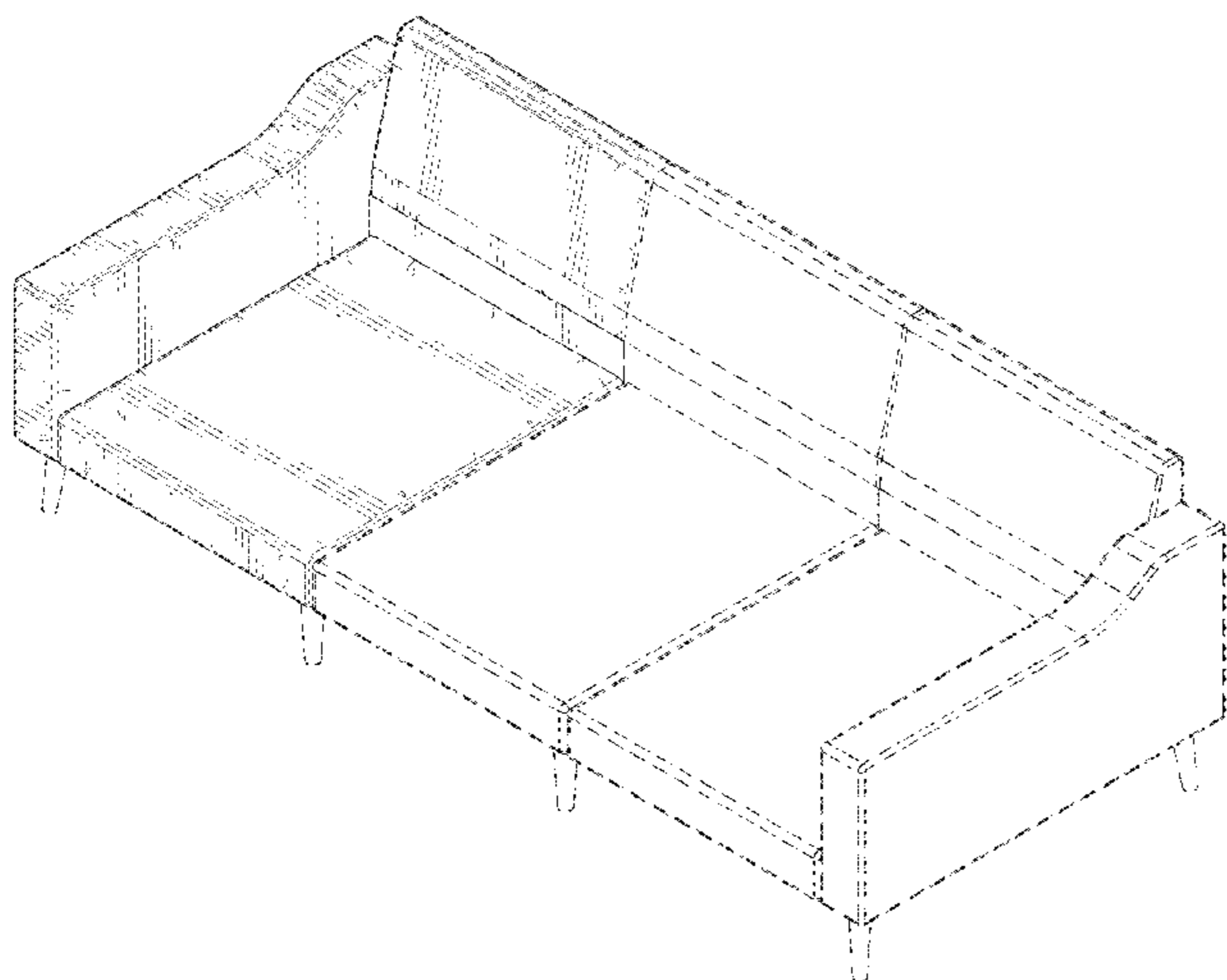

(56)

References Cited

U.S. PATENT DOCUMENTS

10,327,557 B2 * 6/2019 Neil A47C 7/02
D859,859 S * 9/2019 Lopez D6/334
D866,204 S * 11/2019 Neil D6/334
D887,152 S * 6/2020 Kuo D6/381
D895,308 S * 9/2020 Czaja D6/334
11,304,532 B2 * 4/2022 Gunawan A47C 17/02
D951,664 S * 5/2022 Song D6/381
D958,550 S * 7/2022 Andersen D6/335
11,426,004 B1 * 8/2022 Aubé A47C 13/005
D964,767 S * 9/2022 Jehs D6/381
11,457,742 B1 * 10/2022 Zhang A47C 4/02
11,464,339 B2 * 10/2022 Milberg A47C 4/021
2004/0095000 A1 5/2004 Durling
2017/0071354 A1 * 3/2017 Mezzera A47C 4/028

* cited by examiner

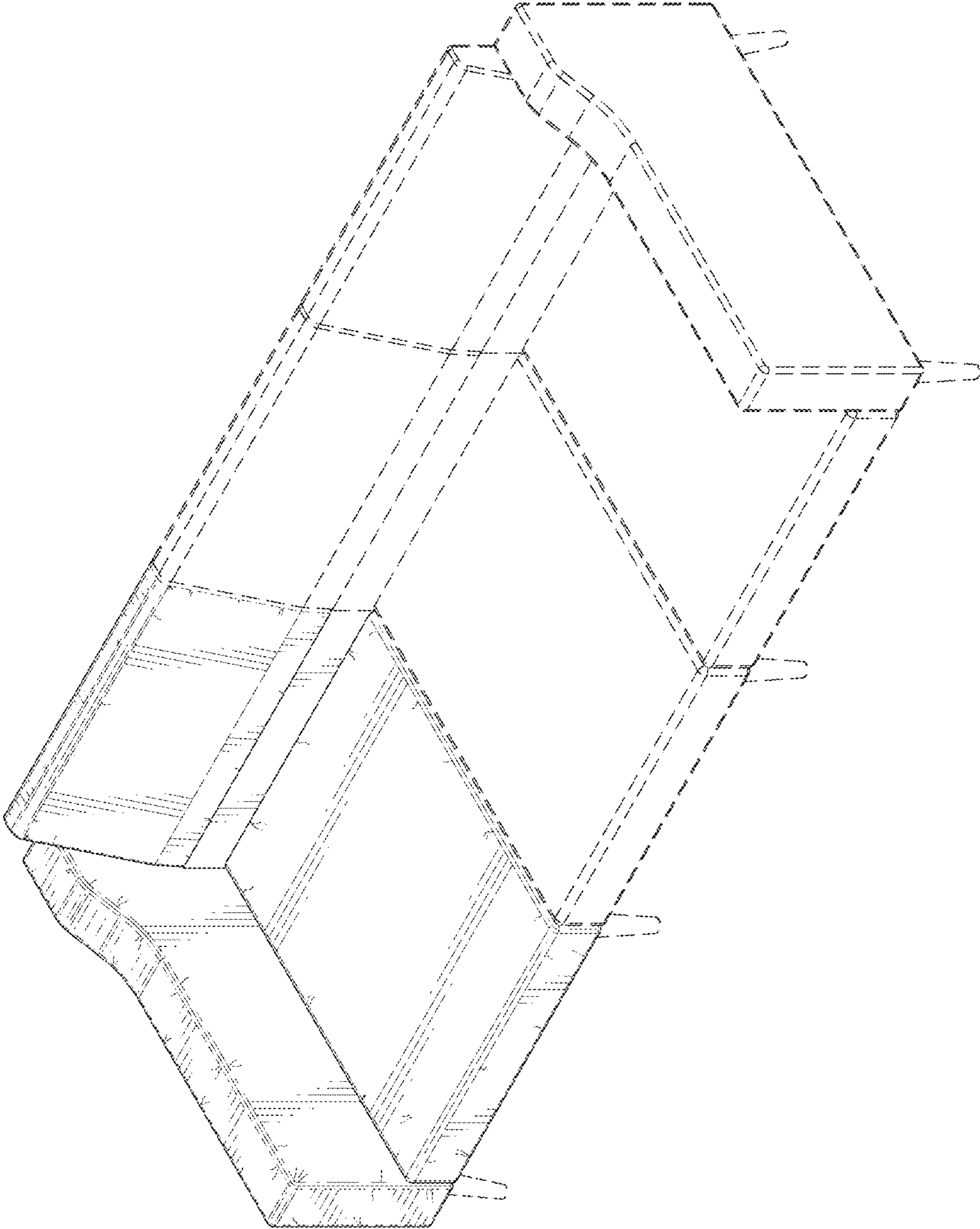

FIG. 1

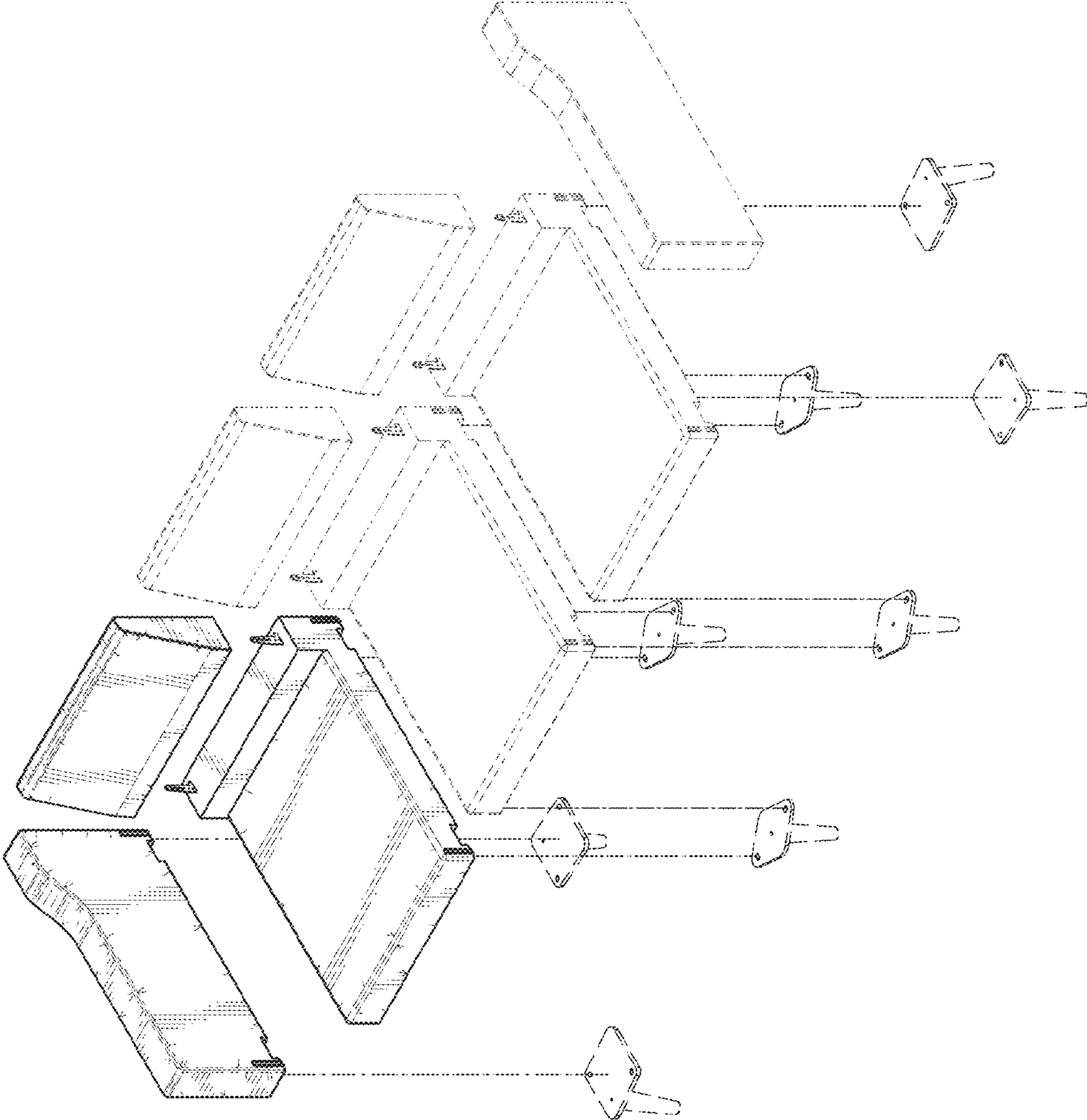

FIG. 2

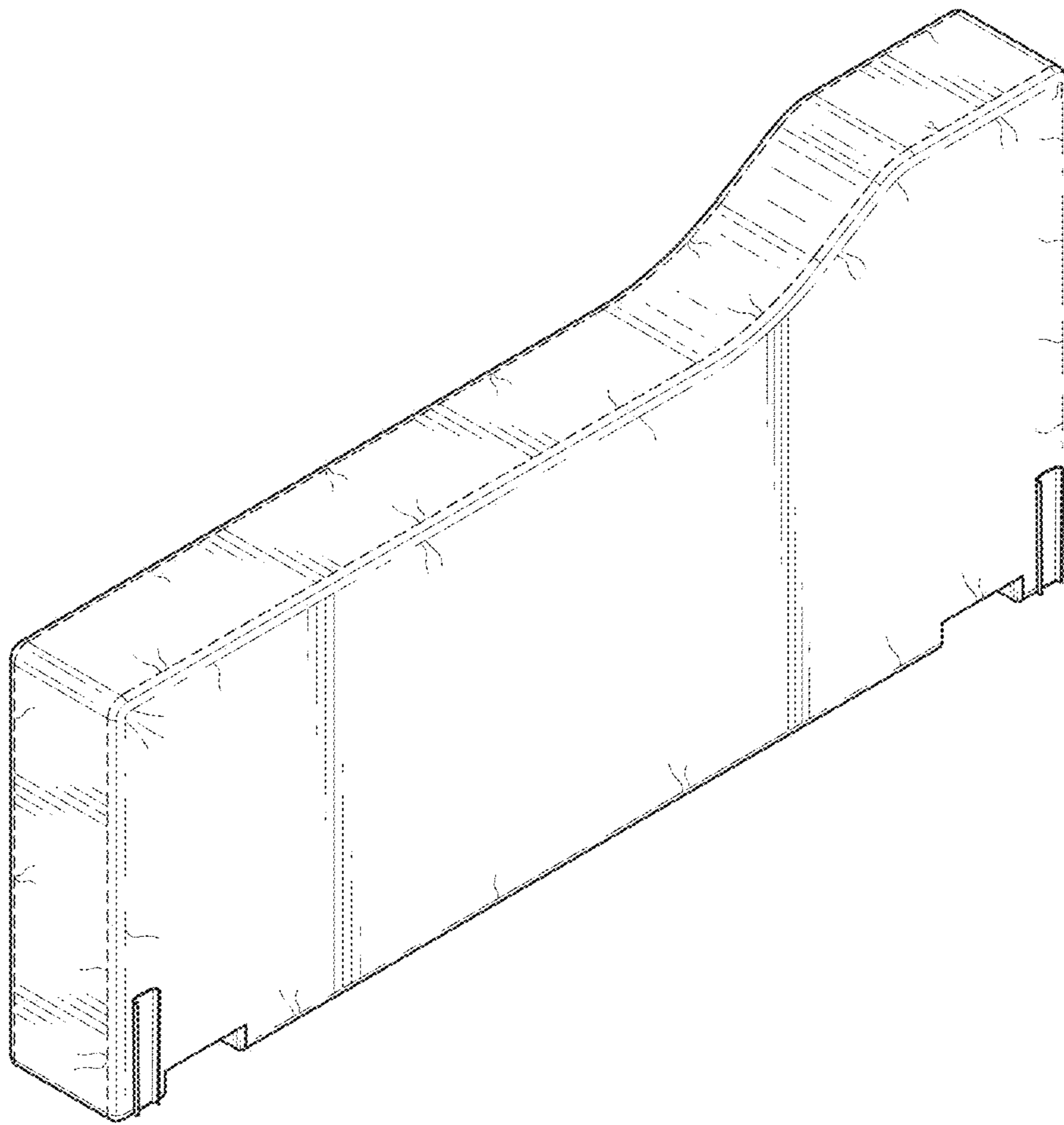

FIG. 3

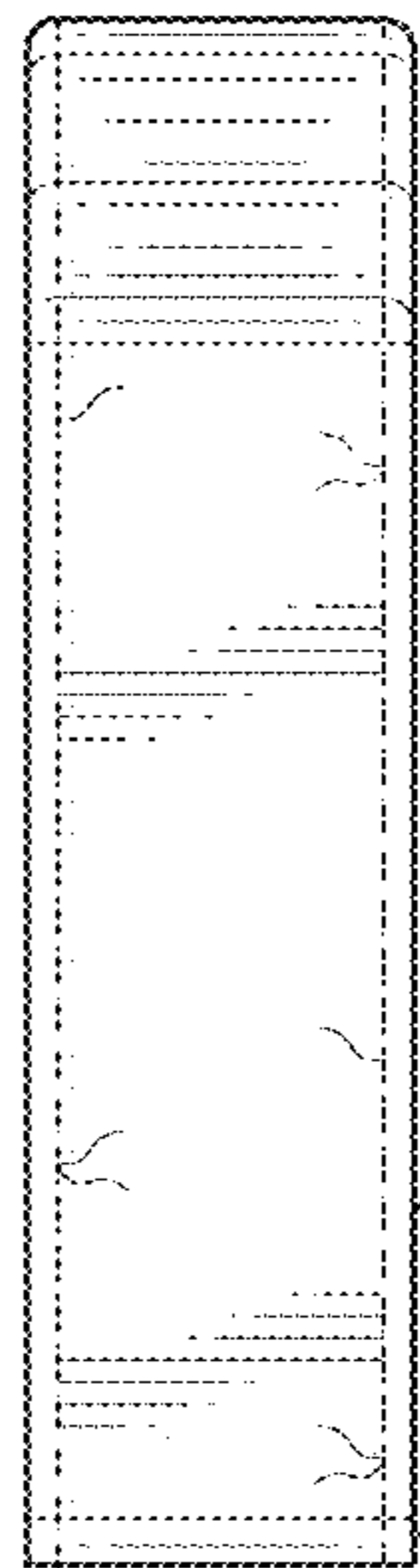

FIG. 4

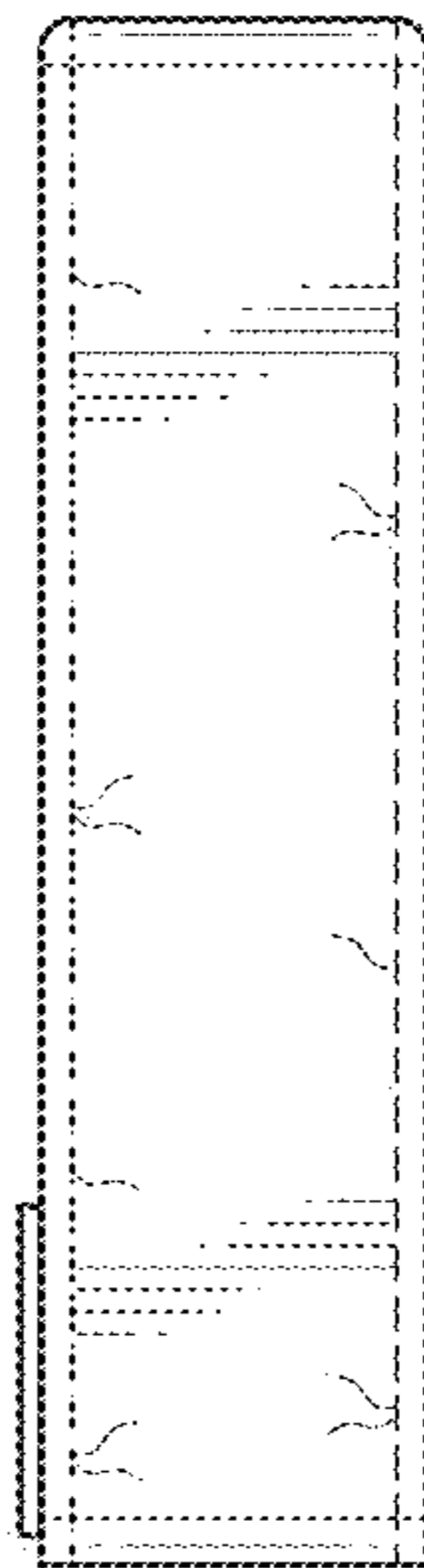

FIG. 5

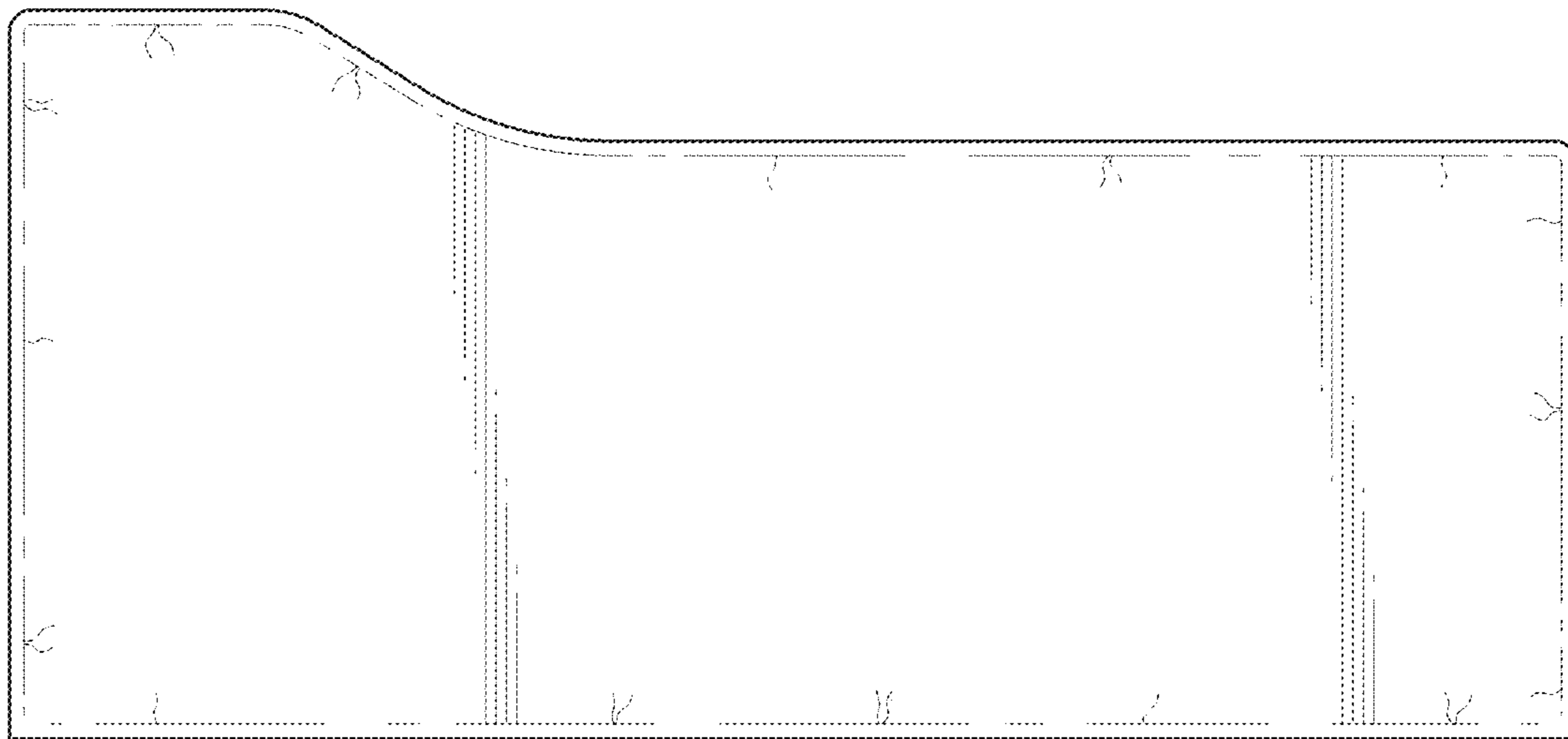

FIG. 6

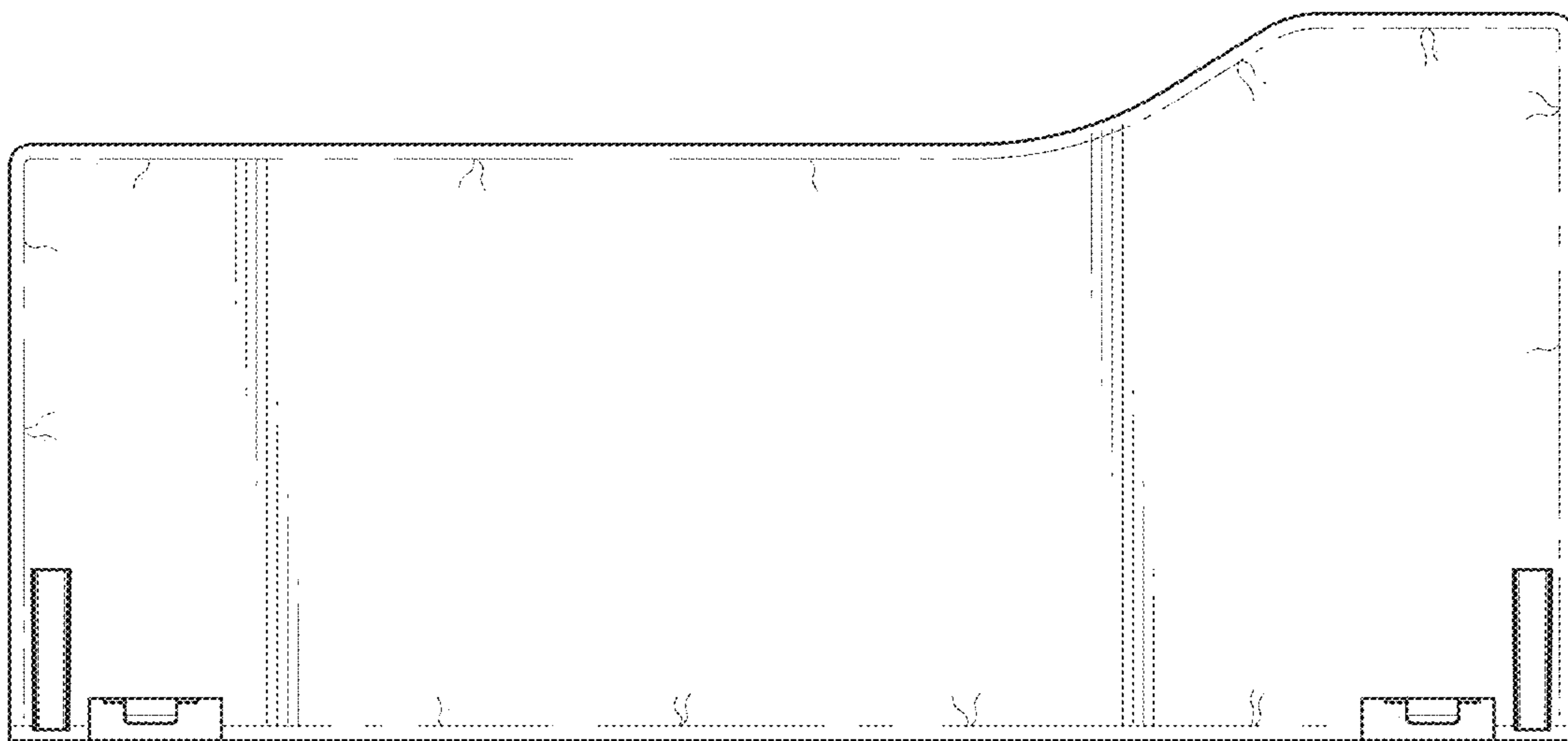

FIG. 7

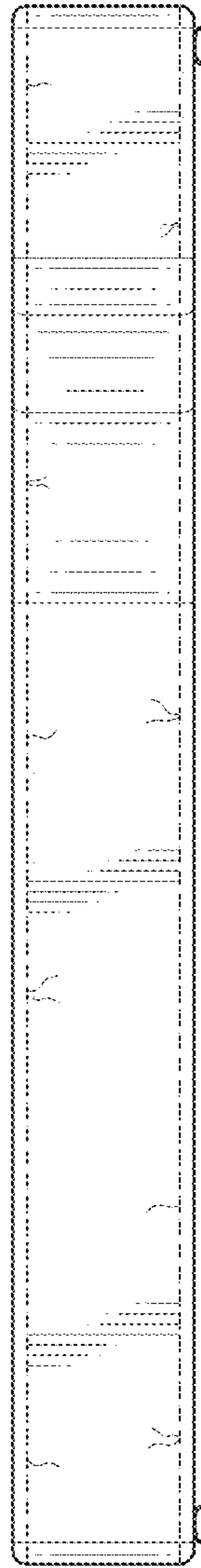

FIG. 8

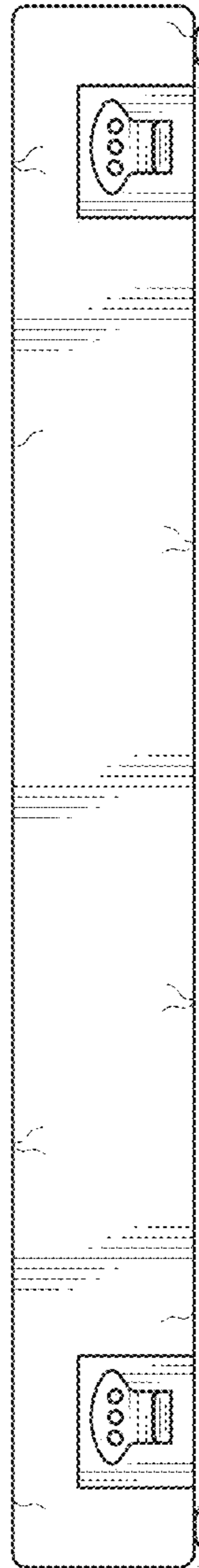

FIG. 9

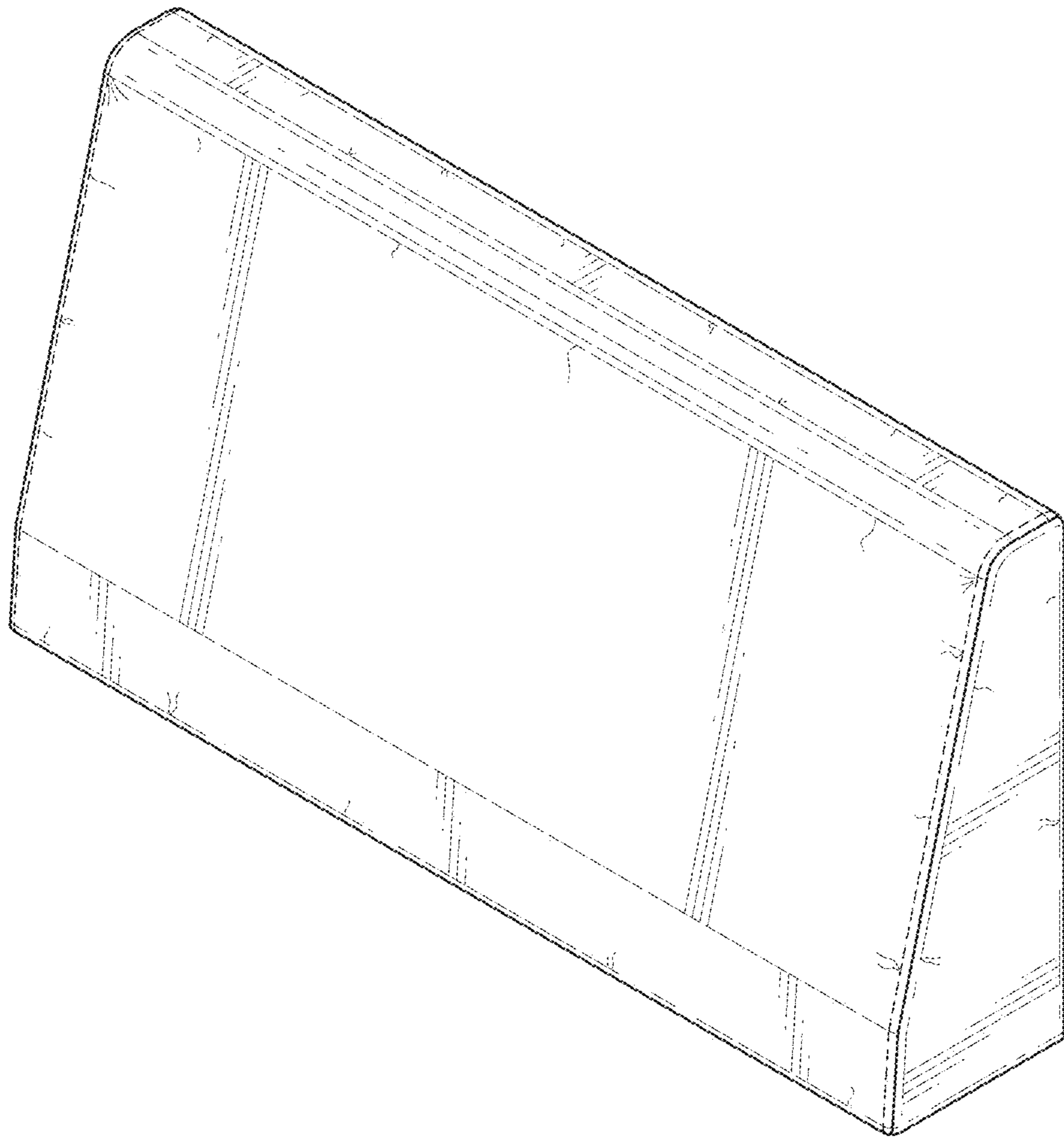

FIG. 10

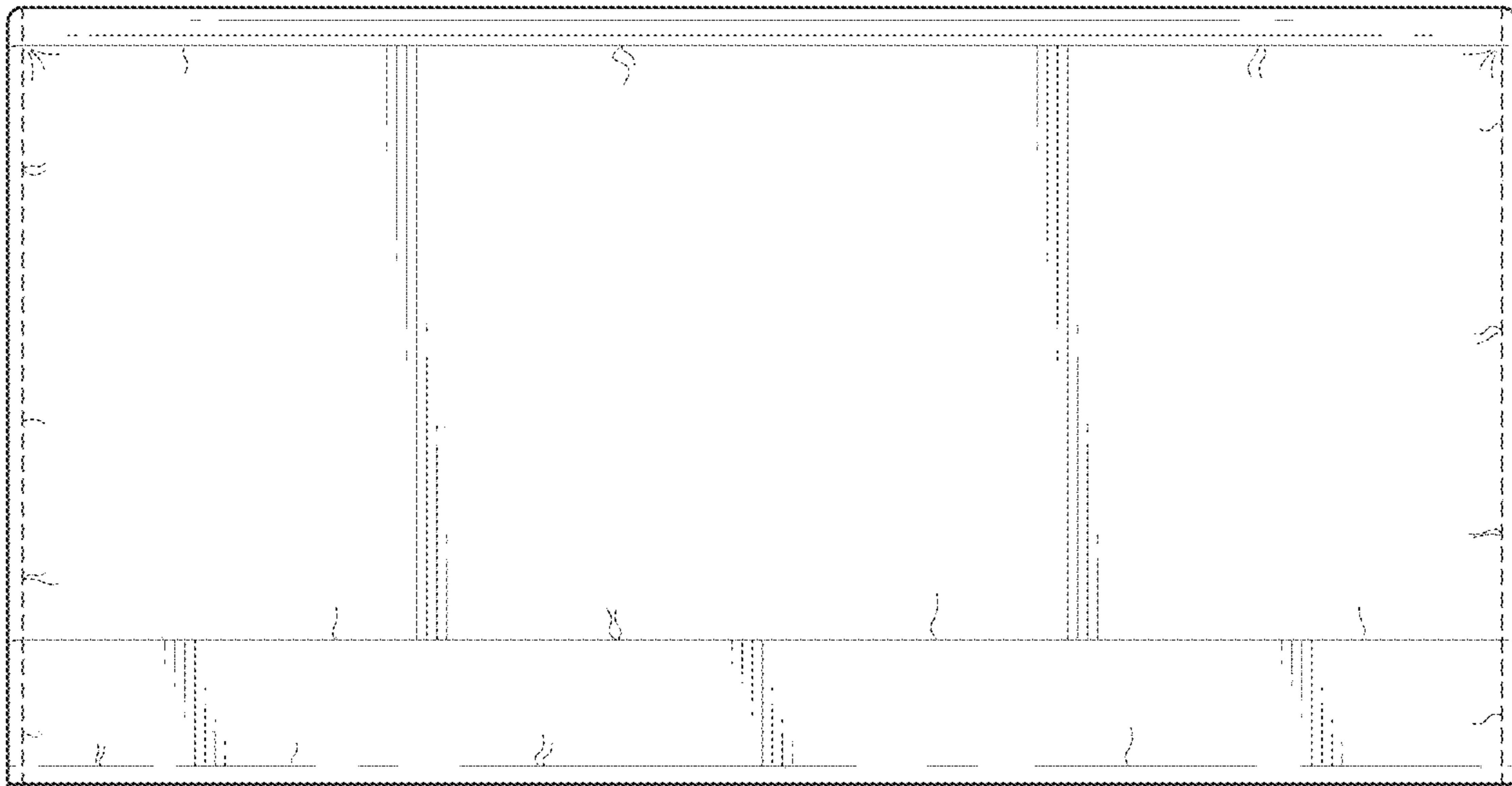

FIG. 11

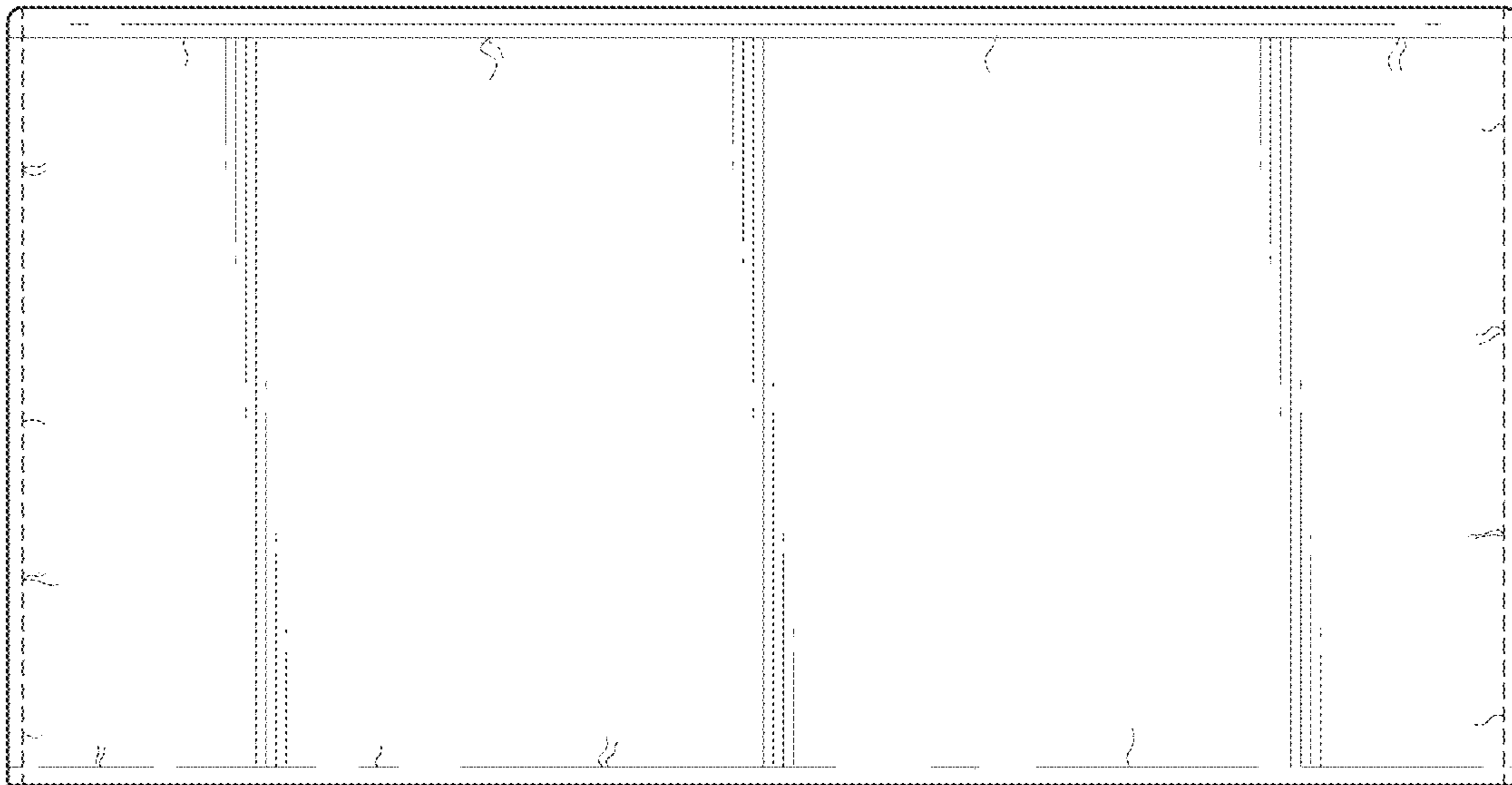

FIG. 12

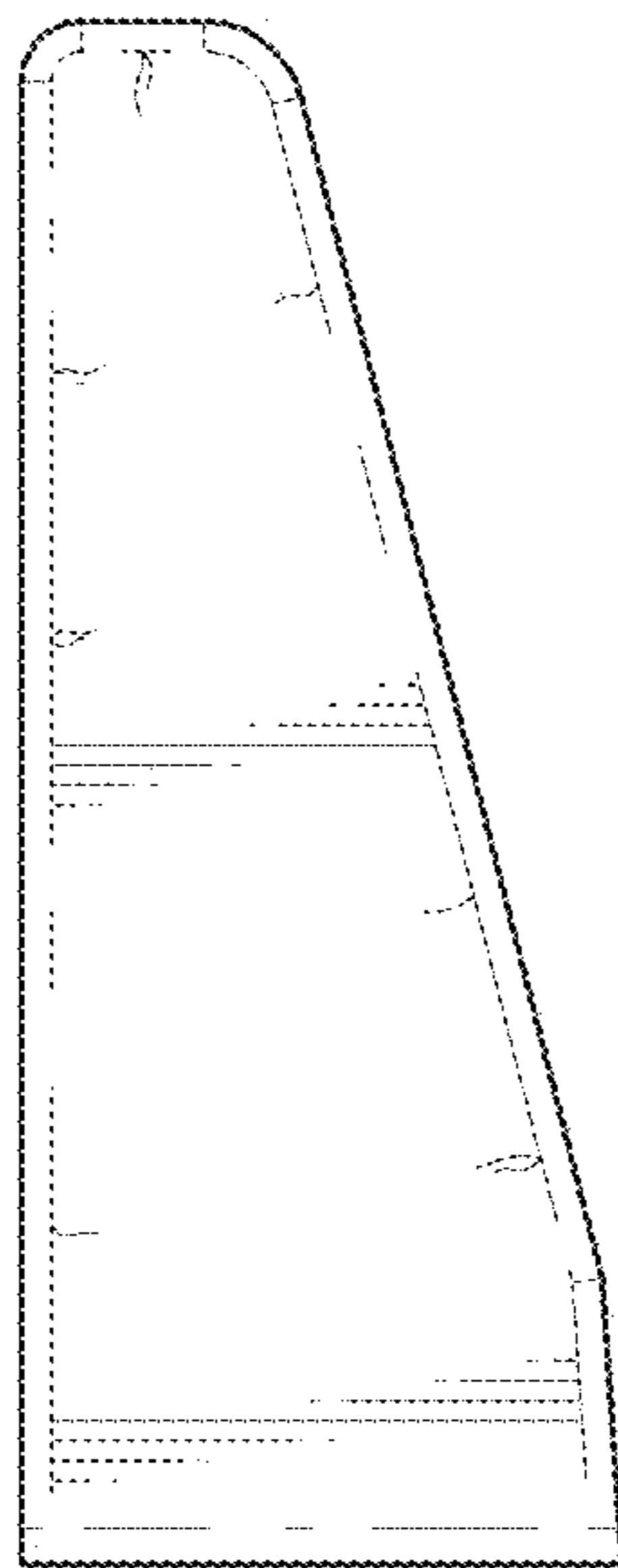

FIG. 13

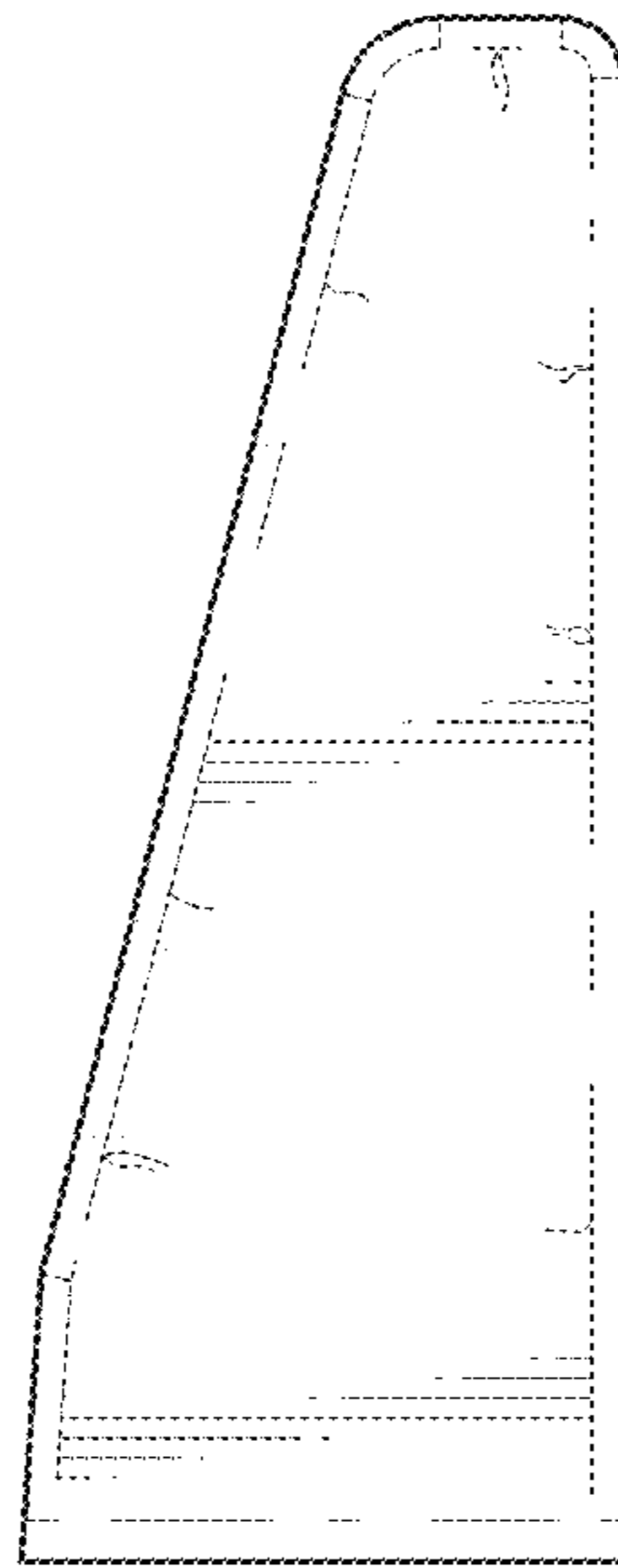

FIG. 14

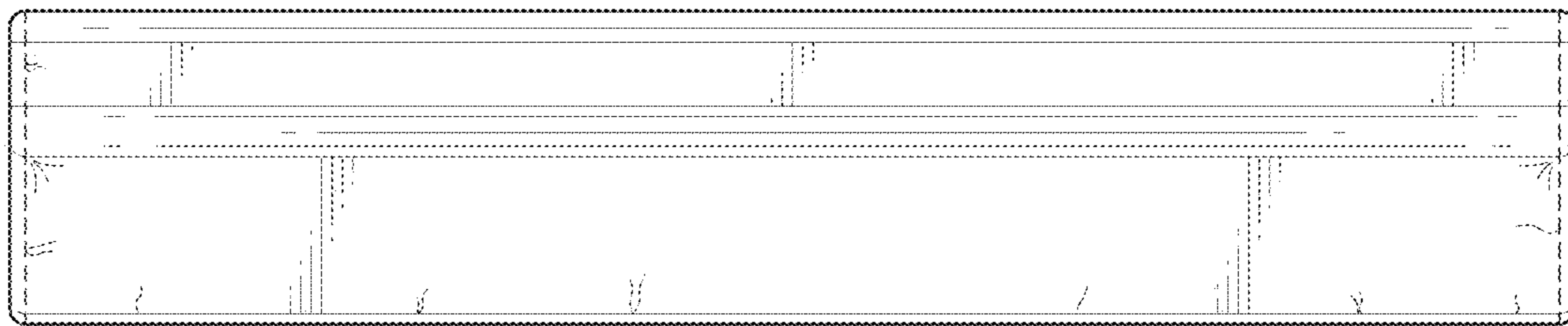

FIG. 15

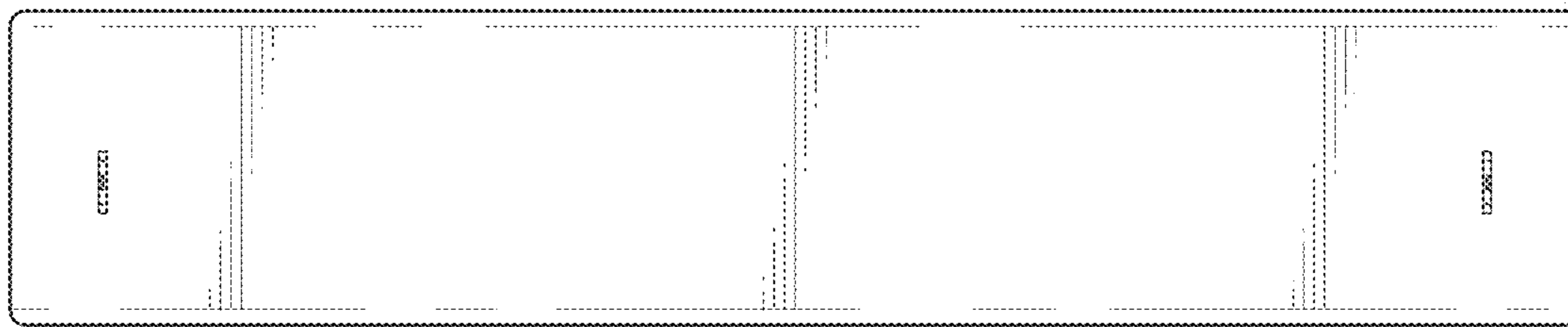

FIG. 16

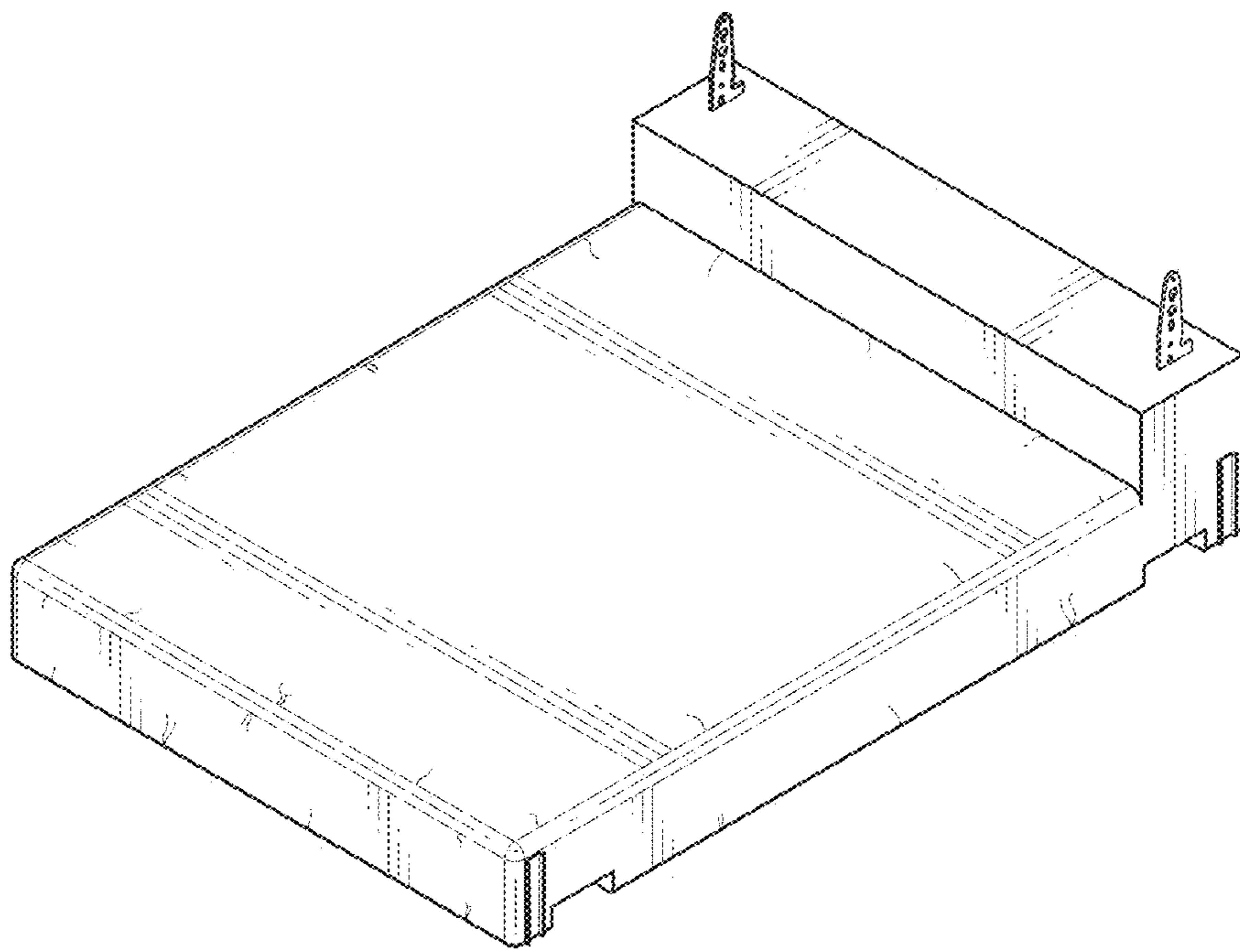

FIG. 17

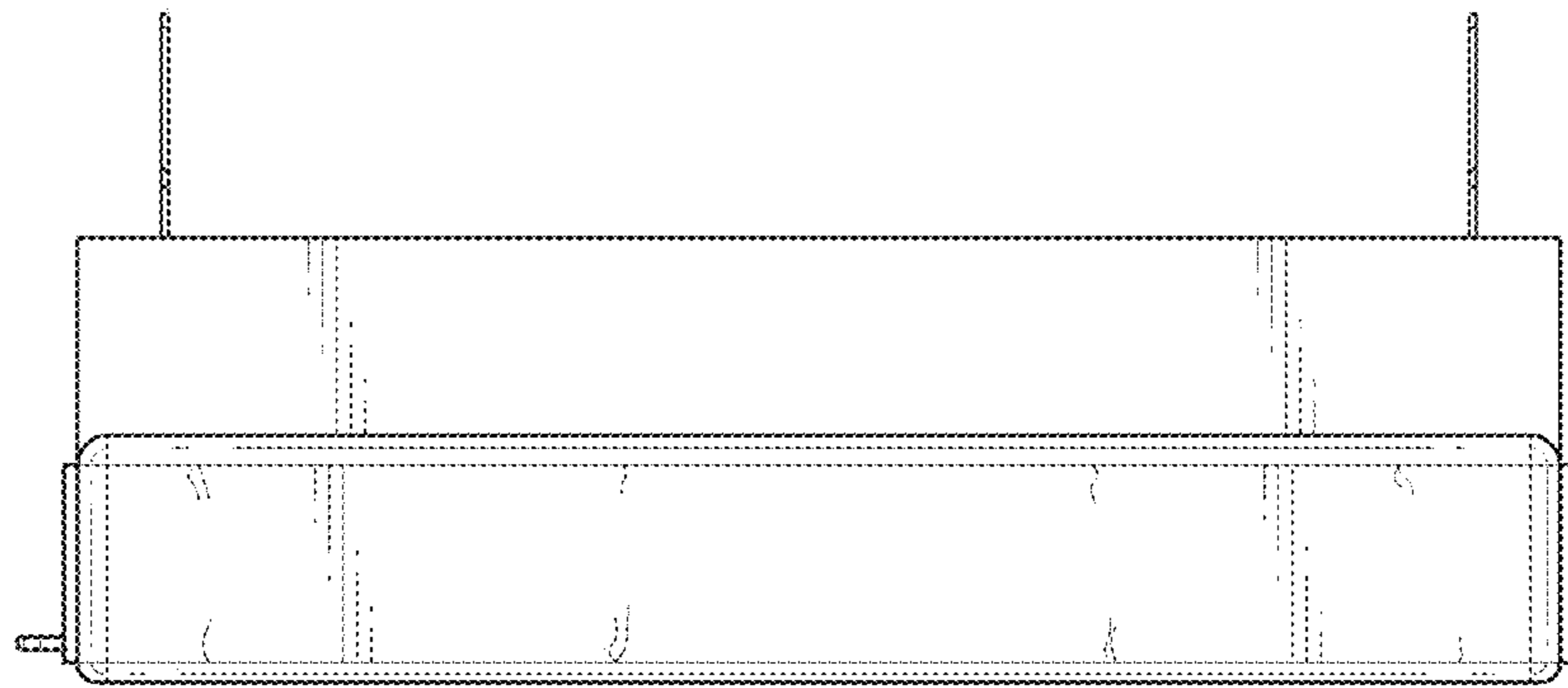

FIG. 18

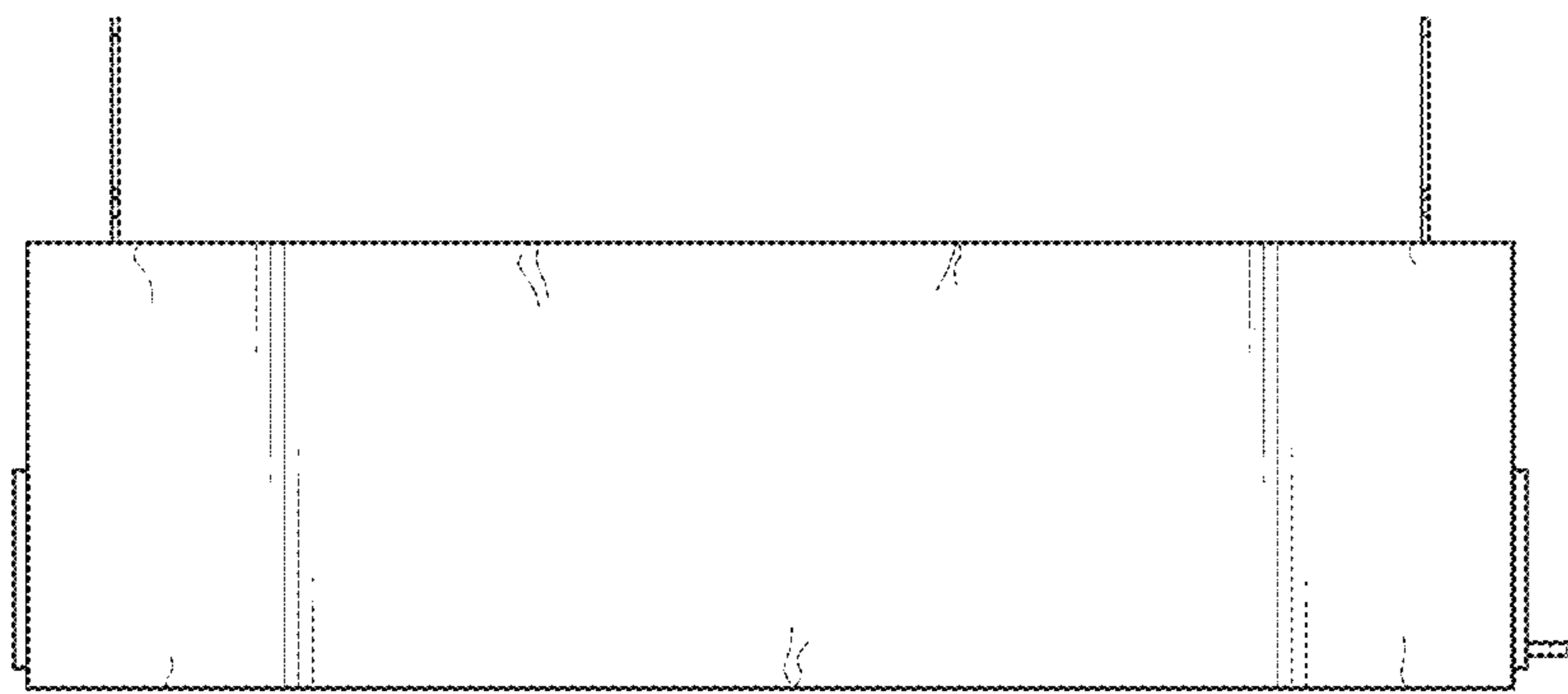

FIG. 19

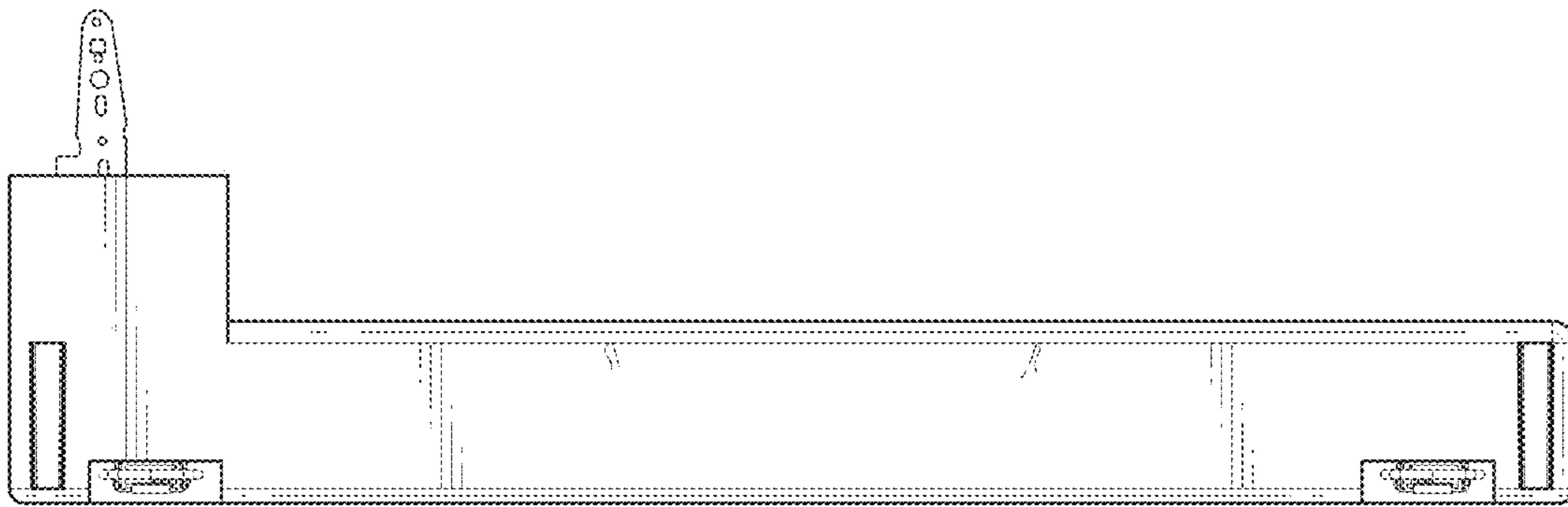

FIG. 20

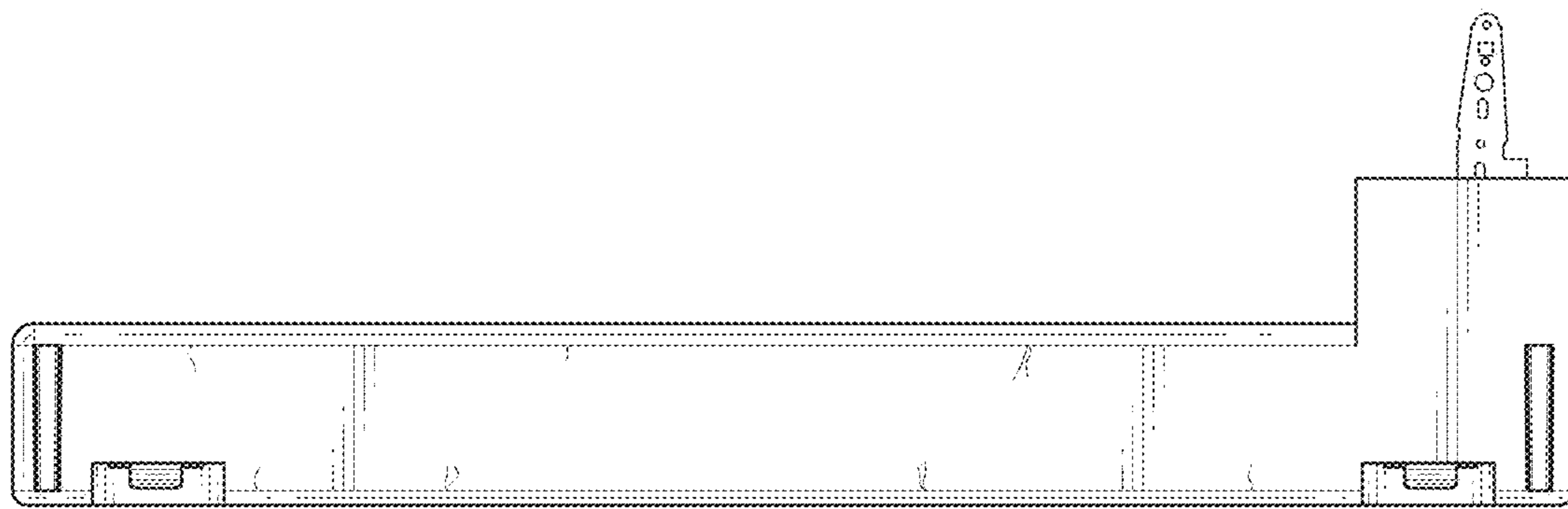

FIG. 21

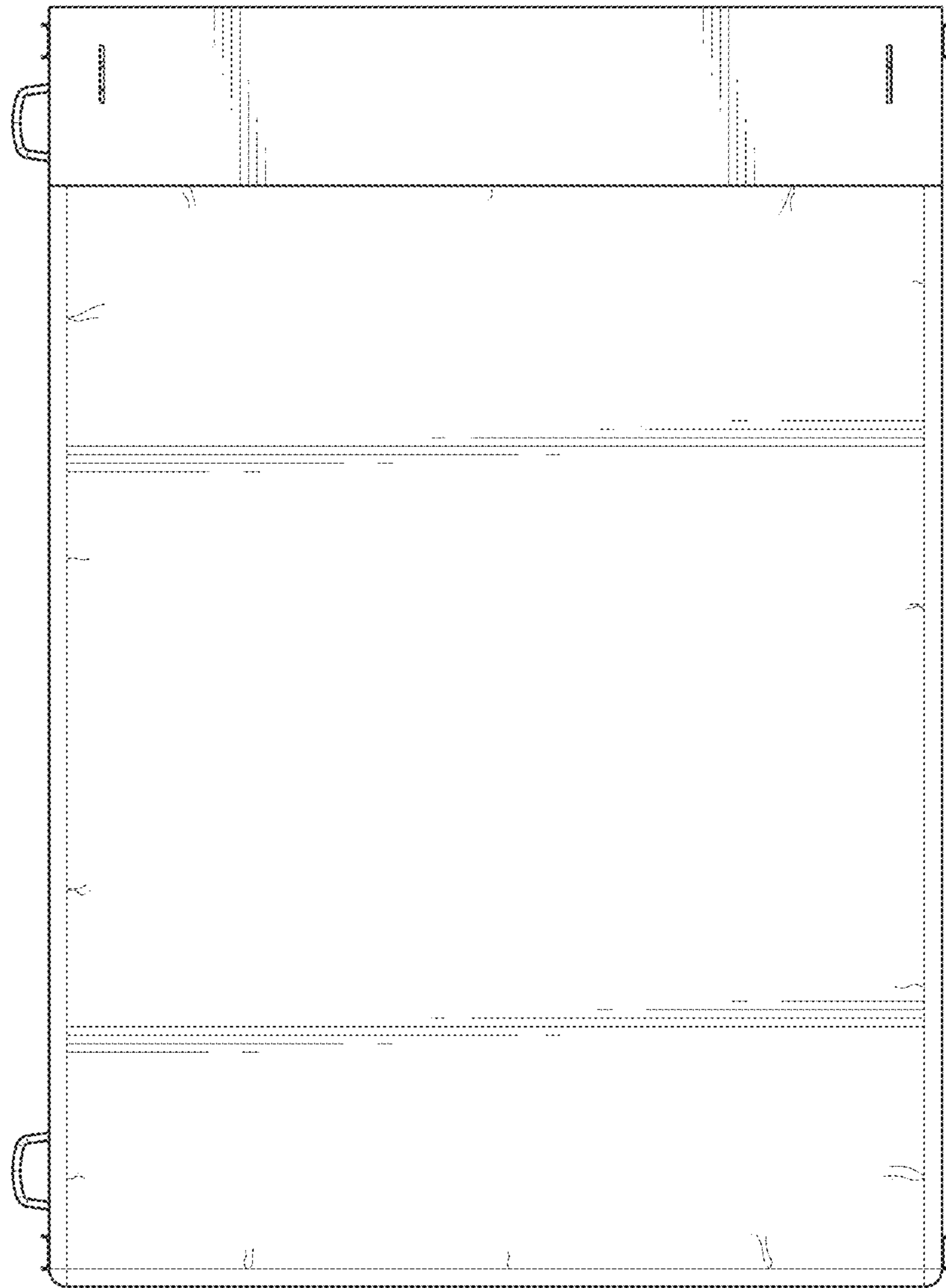

FIG. 22

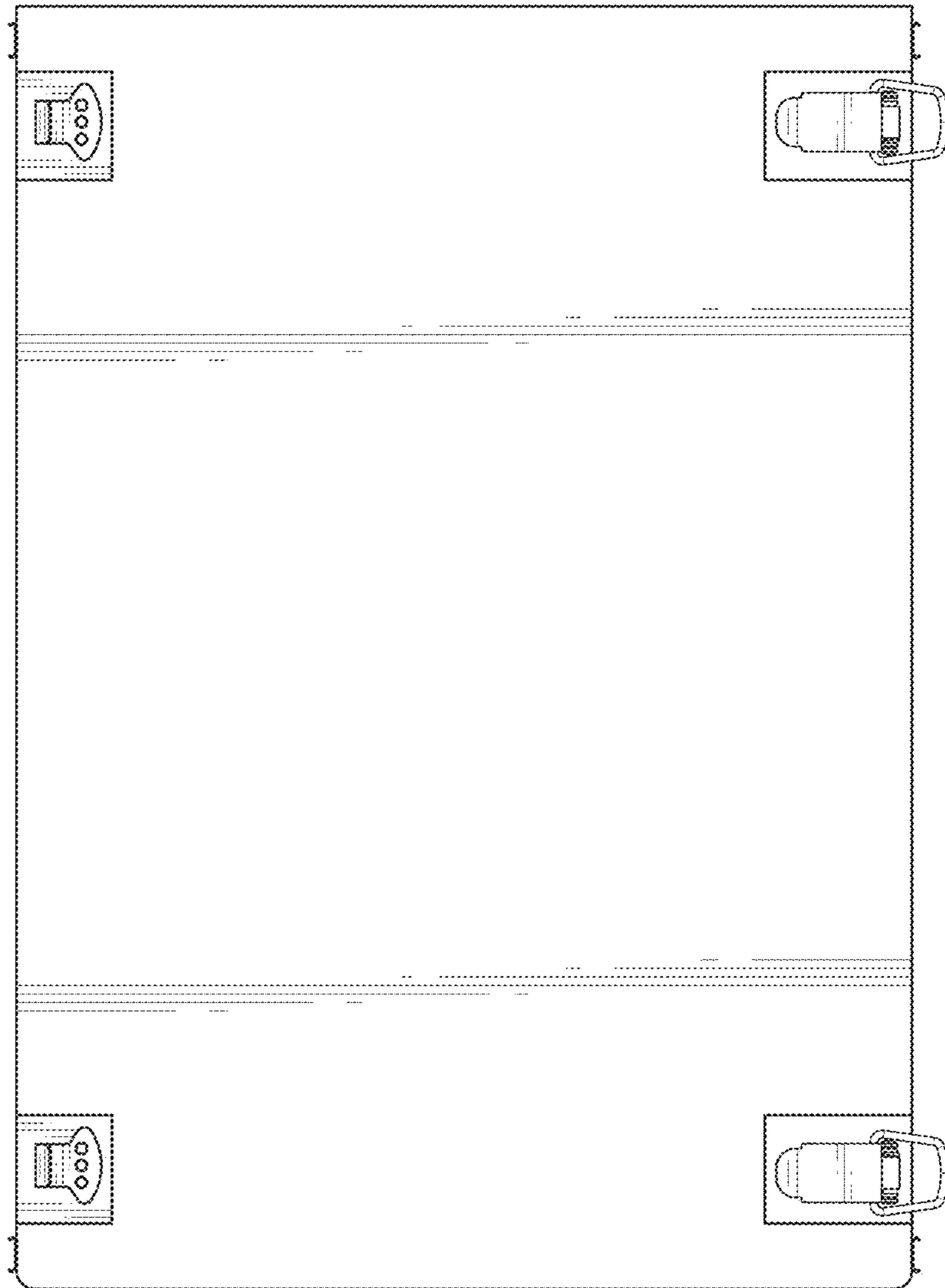

FIG. 23