



US00D982324S

(12) **United States Design Patent**
DeGroot

(10) **Patent No.:** **US D982,324 S**

(45) **Date of Patent:** **** Apr. 4, 2023**

(54) **PAIR OF SHOULDER STRAPS FOR A CARRYING DEVICE**

(71) Applicant: **Melissa S. DeGroot**, Cincinnati, OH (US)

(72) Inventor: **Melissa S. DeGroot**, Cincinnati, OH (US)

(**) Term: **15 Years**

(21) Appl. No.: **29/732,062**

(22) Filed: **Apr. 21, 2020**

(51) **LOC (14) Cl.** **03-01**

(52) **U.S. Cl.**
USPC **D3/327**

(58) **Field of Classification Search**
USPC D3/318, 321-324, 327, 232-246;
D9/434, 443; D11/201; D30/153
CPC .. A44C 5/18; A44C 5/20; A44C 5/185; A45C 1/024; A45C 1/10; A45C 3/00; A45C 3/06; A45C 3/08; A45C 5/00; A45C 5/03; A45C 5/04; A45C 5/14; A45C 13/00; A45C 13/08; A45C 13/10; A45C 13/26; A45C 13/30; A45F 3/02; A45F 3/04; A45F 5/00; A45F 5/10; A45F 5/14; B25H 3/02

See application file for complete search history.

(56) **References Cited**

U.S. PATENT DOCUMENTS

- 1,478,202 A * 12/1923 Cadwell A45C 3/06
206/316.2
- D324,769 S * 3/1992 Hart D3/233
- D416,677 S * 11/1999 Christman D3/232
- D446,644 S * 8/2001 Tucker D3/246
- D462,516 S * 9/2002 Delafontaine D3/246
- 6,640,856 B1 * 11/2003 Tucker A45C 7/0077
150/130
- D489,178 S * 5/2004 McMahan D3/235
- D535,820 S * 1/2007 Kamiya D3/246

- D681,947 S * 5/2013 Weinshanker D3/232
- D723,246 S * 3/2015 Schultz D2/627
- D724,317 S * 3/2015 Proteau D3/232
- D787,823 S * 5/2017 Nair D3/246

(Continued)

OTHER PUBLICATIONS

The Simple Tote in Fair Trade + GOTS Organic Cotton, unknown first available date, tothemarket.com [online], [site visited Nov. 29, 2021], Available at URL: <https://tothemarket.com/collections/totes/products/simple-tote-in-fair-trade-gots-organic-cotton> (Year: 2021).*

(Continued)

Primary Examiner — Jeffrey D Asch
Assistant Examiner — Caitlin A Lavery
(74) *Attorney, Agent, or Firm* — FisherBroyles, LLP;
Susan M. Oiler

(57) **CLAIM**

The ornamental design for a pair of shoulder straps for a carrying device, as shown and described.

DESCRIPTION

FIG. 1 is a front perspective view of the pair of shoulder straps for a carrying device of my design;
FIG. 2 is a front elevation view thereof;
FIG. 3 is a rear elevation view thereof;
FIG. 4 is a left-side elevation view thereof;
FIG. 5 is a right-side elevation view thereof;
FIG. 6 is a top view thereof; and,
FIG. 7 is a bottom view thereof.

The longer evenly dashed broken lines, which show a carrying device and portions of the pair of shoulder straps, form no part of the claimed design. The dot-dash broken lines define a boundary of the claimed design. The shorter evenly spaced broken lines represent stitching, which is included in the claim only when shown on solid line surfaces.

1 Claim, 5 Drawing Sheets

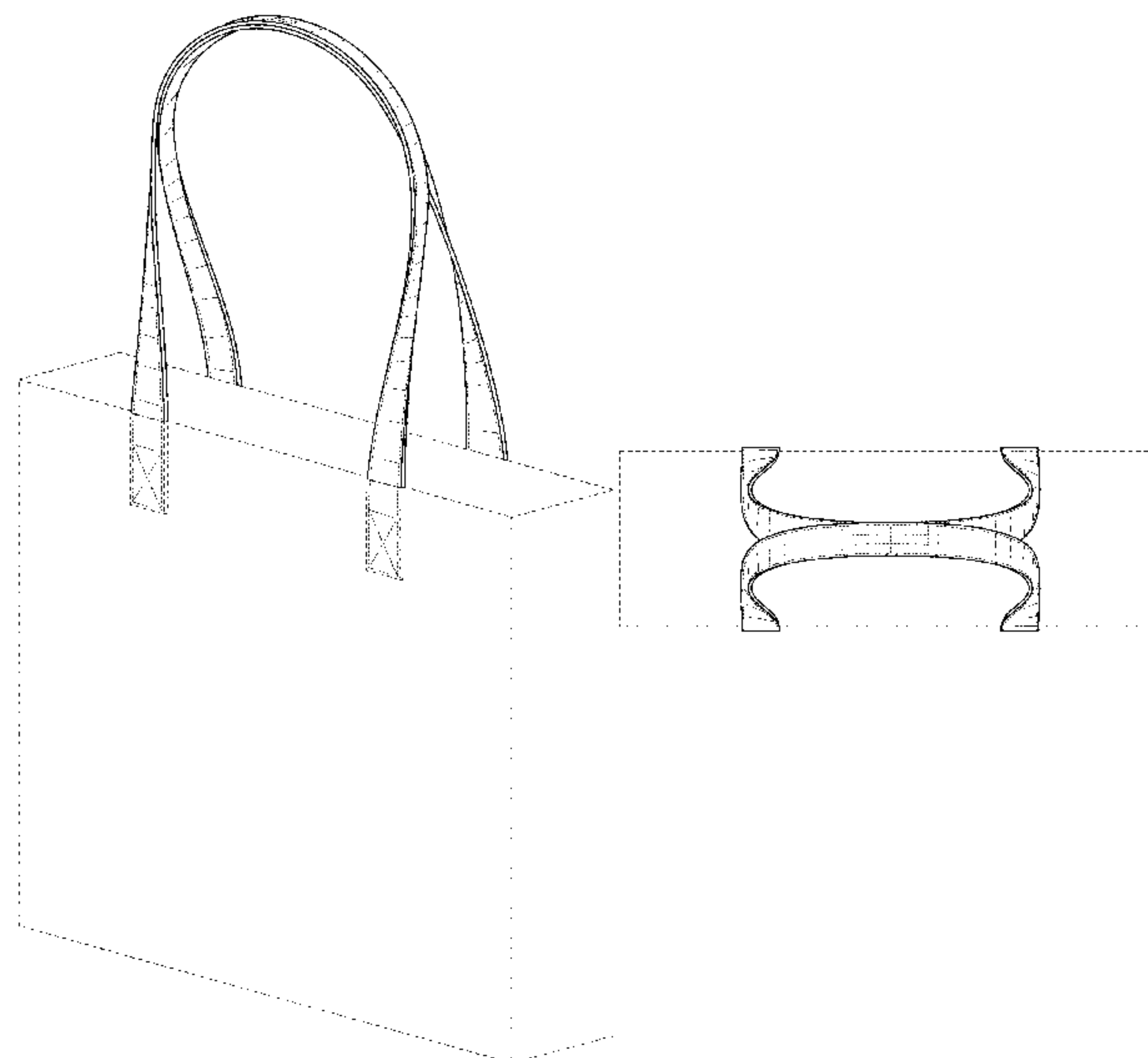

(56)

References Cited

U.S. PATENT DOCUMENTS

D814,790	S *	4/2018	Yuson	D3/246
D824,164	S *	7/2018	Casilio	D3/246
D824,666	S *	8/2018	Carter	D3/245
D831,764	S *	10/2018	Hetrick	D21/694
D831,959	S *	10/2018	Hollinger	D3/246
D851,404	S *	6/2019	Seiders	D3/318
D859,813	S *	9/2019	Seiders	D3/201
D859,826	S *	9/2019	Ferrero	D3/245
D861,335	S *	10/2019	Barlier	D3/232
D874,132	S *	2/2020	Hubbell	D3/245
D876,206	S *	2/2020	Pinholster	D8/356
D904,758	S *	12/2020	Bullock	D3/246
D915,070	S *	4/2021	Wang	D3/283
2011/0146856	A1 *	6/2011	Vancelette	A45C 15/00
				150/117
2013/0037431	A1 *	2/2013	Lin	A45F 3/005
				206/278
2021/0321749	A1 *	10/2021	DeGroot	A45C 13/30

OTHER PUBLICATIONS

BAGGU Canvas Reusable Retail Tote, first available May 9, 2019, amazon.com [online], [site visited Nov. 29, 2021], Available at URL: https://www.amazon.com/BAGGU-Reusable-Shopping-Recycled-Apricot/dp/B07RK5NJZR/ref=pd_lpo_3?pd_rd_i=B07SQ46LCC&th=1 (Year: 2019).*

9 oz Lightweight Cotton Tote Bag, first available Dec. 9, 2014, amazon.com [online], [site visited Nov. 29, 2021], Available at URL: <https://www.amazon.com/Lightweight-Cotton-Tote-Bag/dp/B00QSIWUBK> (Year: 2014).*

* cited by examiner

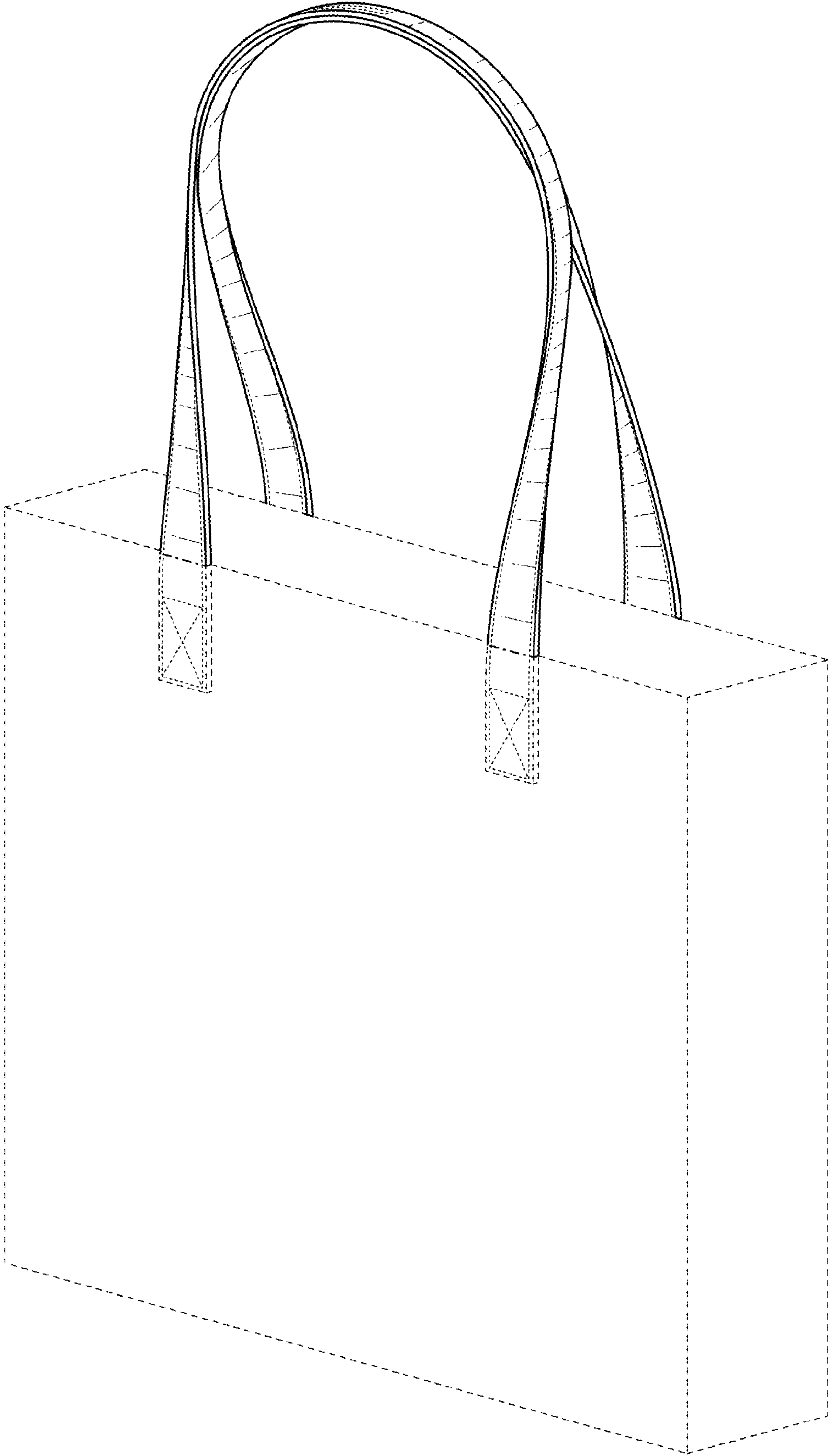

FIG. 1

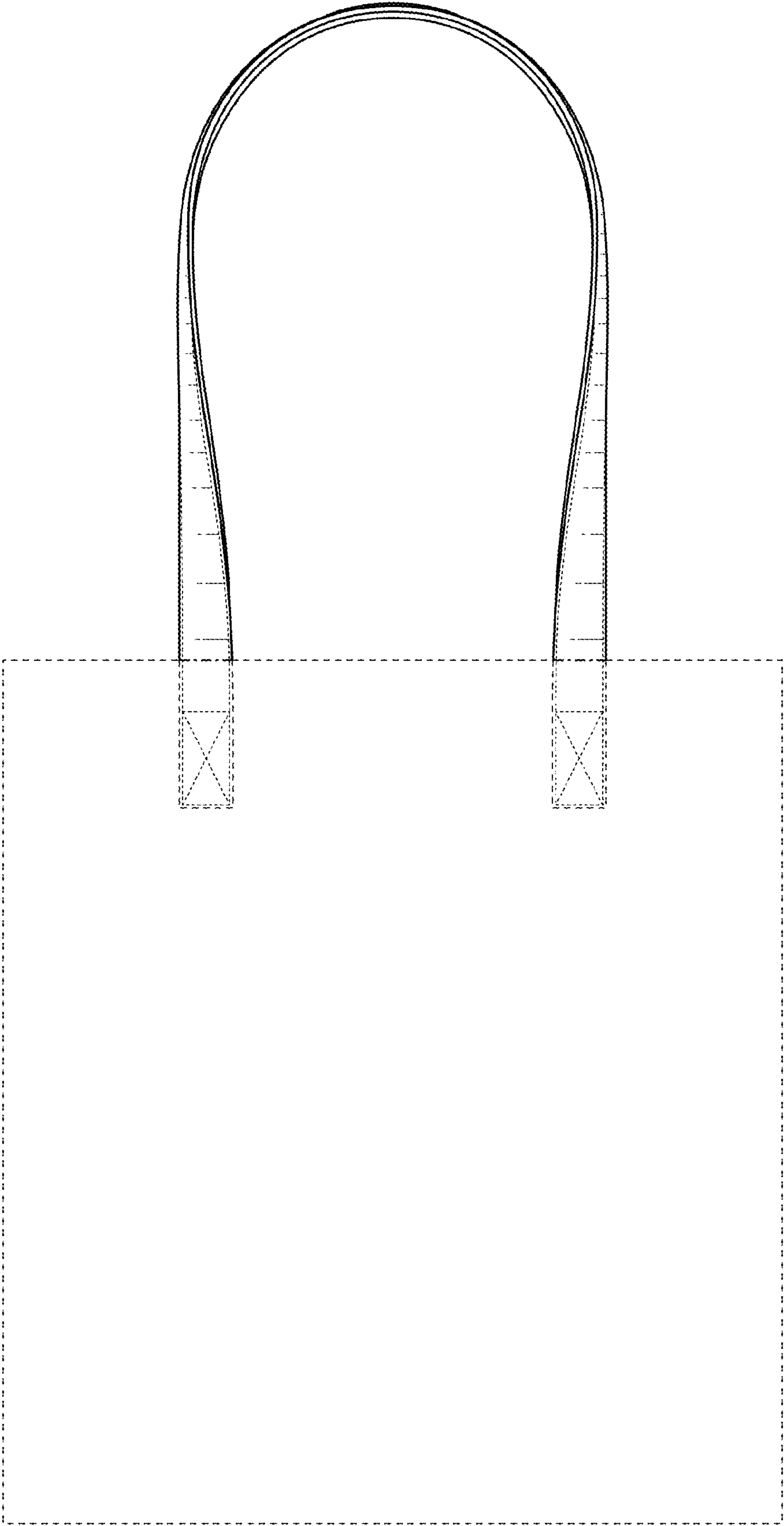

FIG. 2

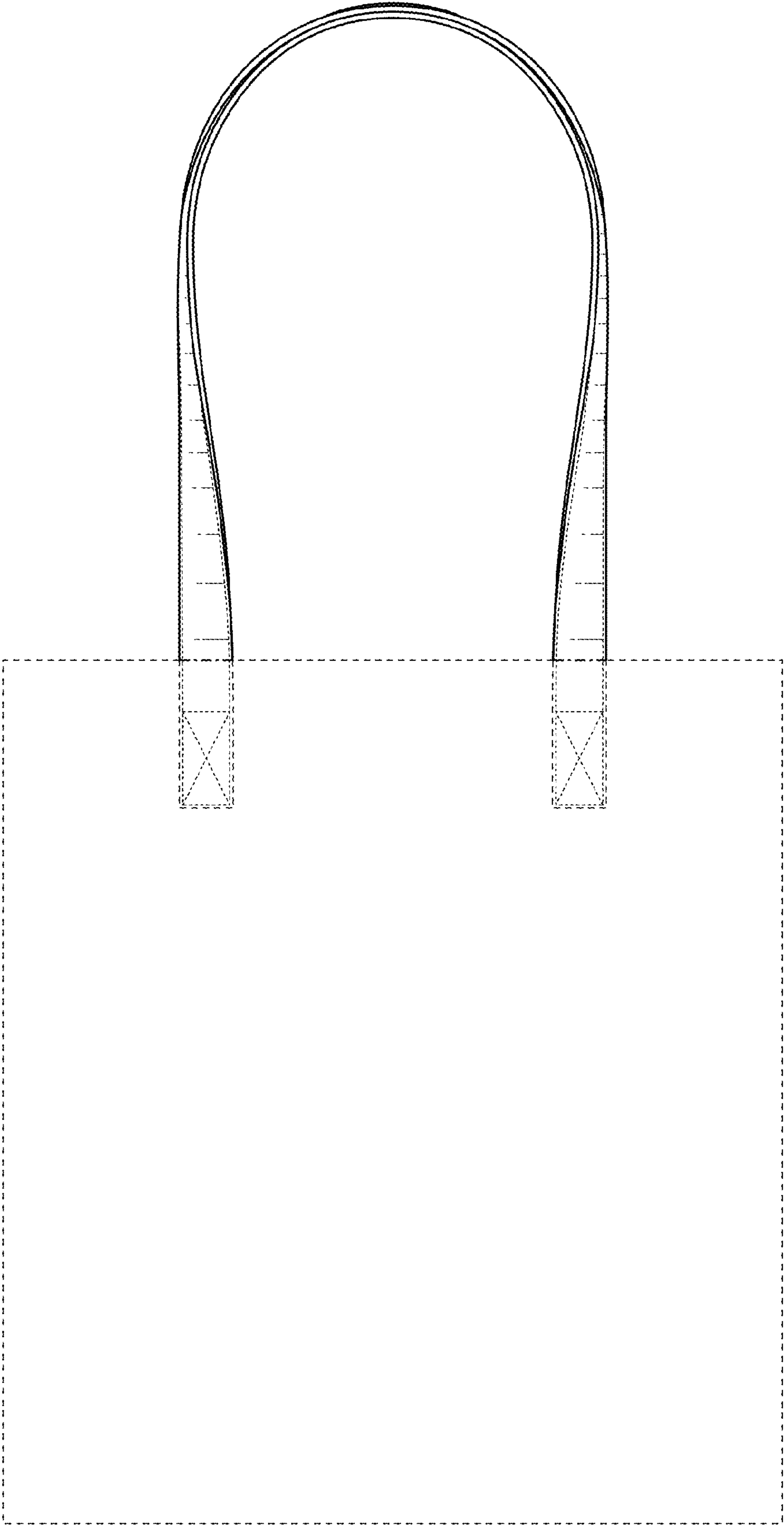

FIG. 3

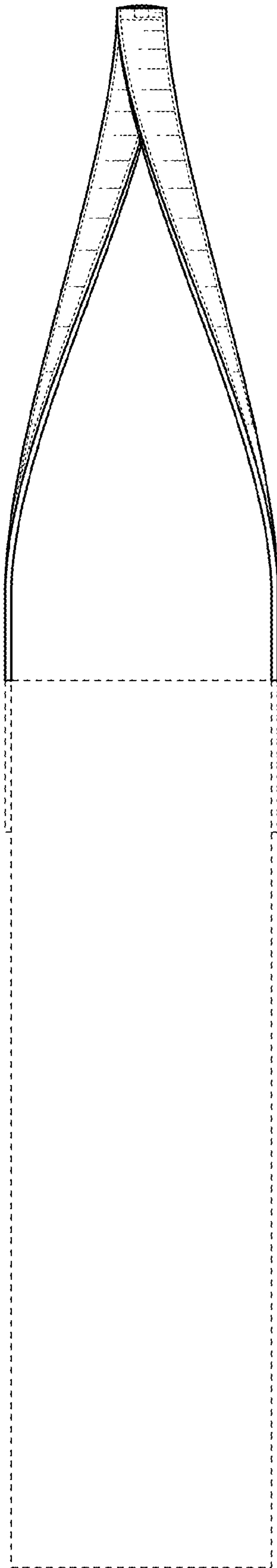

FIG. 4

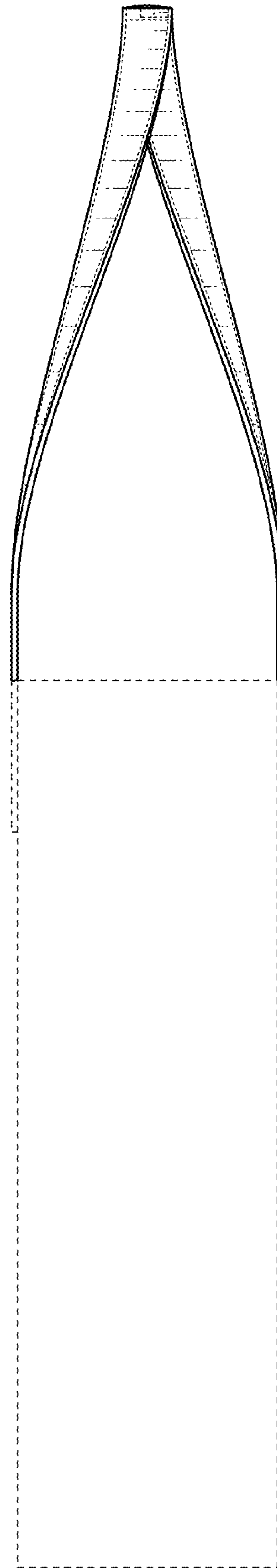

FIG. 5

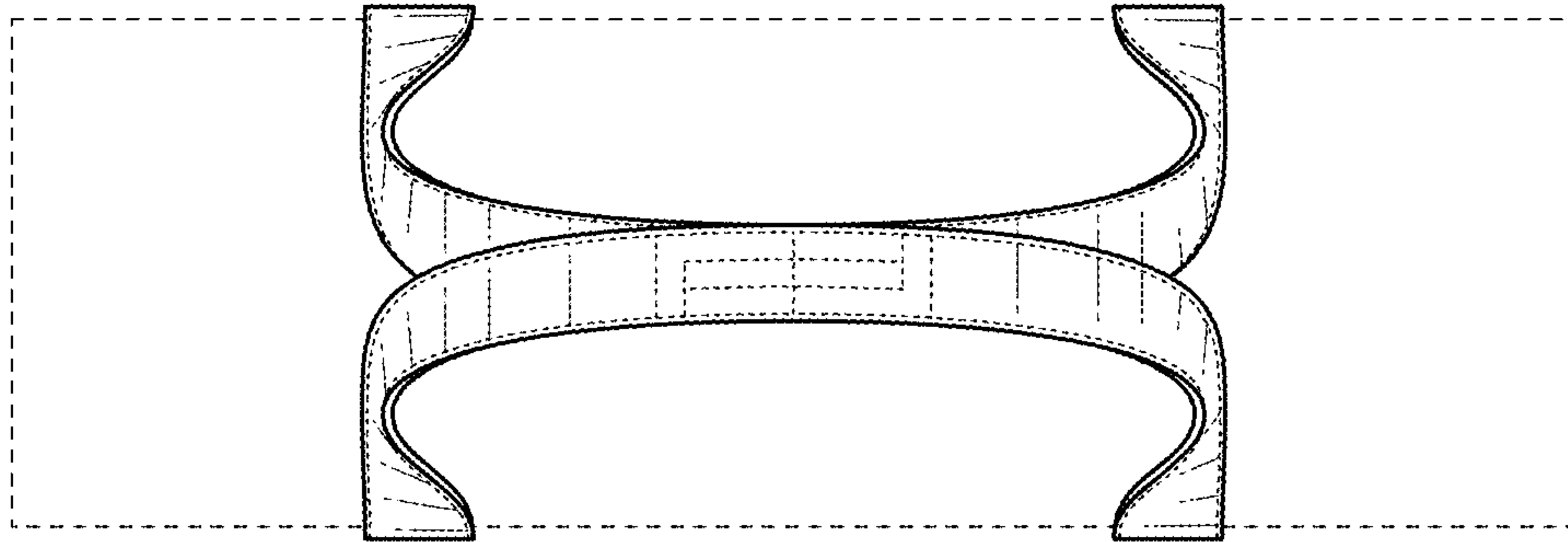

FIG. 6



FIG. 7