



US00D982323S

(12) **United States Design Patent** (10) **Patent No.:** **US D982,323 S**
Sommer (45) **Date of Patent:** **** Apr. 4, 2023**

(54) **CONTAINER DIVIDER**
(71) Applicant: **Monoflo International, Inc.**,
Winchester, VA (US)
(72) Inventor: **Axel Sommer**, Tacoma, WA (US)
(73) Assignee: **MONOFLO INTERNATIONAL,**
INC., Winchester, VA (US)
(**) Term: **15 Years**

11,109,704 B2 * 9/2021 Mandich A47D 5/00
D944,015 S * 2/2022 Greenwood A45C 13/02
D3/319
11,242,175 B2 * 2/2022 Barfoot B65D 81/3818
11,267,637 B2 * 3/2022 Barfoot B65D 5/48024
2016/0176577 A1 * 6/2016 Frankenberg B65D 25/06
220/533

(21) Appl. No.: **29/787,420**
(22) Filed: **Jun. 7, 2021**
(51) **LOC (14) Cl.** **03-01**
(52) **U.S. Cl.**
USPC **D3/319**
(58) **Field of Classification Search**
USPC D3/201, 245, 246, 304-309, 315, 318,
D3/319, 323, 328; D6/675, 683;
D9/414, 424, 425, 427, 432, 452, 456
CPC B65D 85/00; B65D 85/34; B65D 11/00;
B65D 11/20; B65D 1/00; B65D 1/22;
B65D 1/243; B65D 71/0003; B65D
71/0007
See application file for complete search history.

FOREIGN PATENT DOCUMENTS

GB 6186077 * 1/2022
JP D1680277 * 3/2021
JP D1680326 * 3/2021

OTHER PUBLICATIONS

Baseline Plus Bekuplast, posted at youtube.com, first available
Mar. 1, 2021, retrieved on Jan. 5, 2023, online, <https://www.youtube.com/watch?v=wEOiBycVtnQ> (Year: 2021).*
(Continued)

Primary Examiner — Barbara Fox
Assistant Examiner — Dustin Andrew Griffith
(74) *Attorney, Agent, or Firm* — Nixon & Vanderhye P.C.

(56) **References Cited**

U.S. PATENT DOCUMENTS

D237,235 S * 10/1975 Iacurto et al. D6/675
4,577,773 A * 3/1986 Bitel B25H 3/02
206/561
D502,031 S * 2/2005 Cassidy D3/319
D564,764 S * 3/2008 Springer B65D 25/06
D6/332
7,984,820 B2 * 7/2011 Dancyger A45C 13/02
220/532
D773,864 S * 12/2016 Yoshikawa B65D 81/3818
D6/675
D902,719 S * 11/2020 Dwork B25H 3/02
D9/456
D903,494 S * 12/2020 Dwork D9/456

DESCRIPTION

FIG. 1 is a perspective view of a container divider showing
the new design;
FIG. 2 is a front view thereof;
FIG. 3 is a rear view thereof;
FIG. 4 is a top view thereof;
FIG. 5 is a bottom view thereof;
FIG. 6 is one side view thereof;
FIG. 7 is an opposite side view thereof; and,
FIG. 8 is an alternative perspective view thereof.

1 Claim, 6 Drawing Sheets

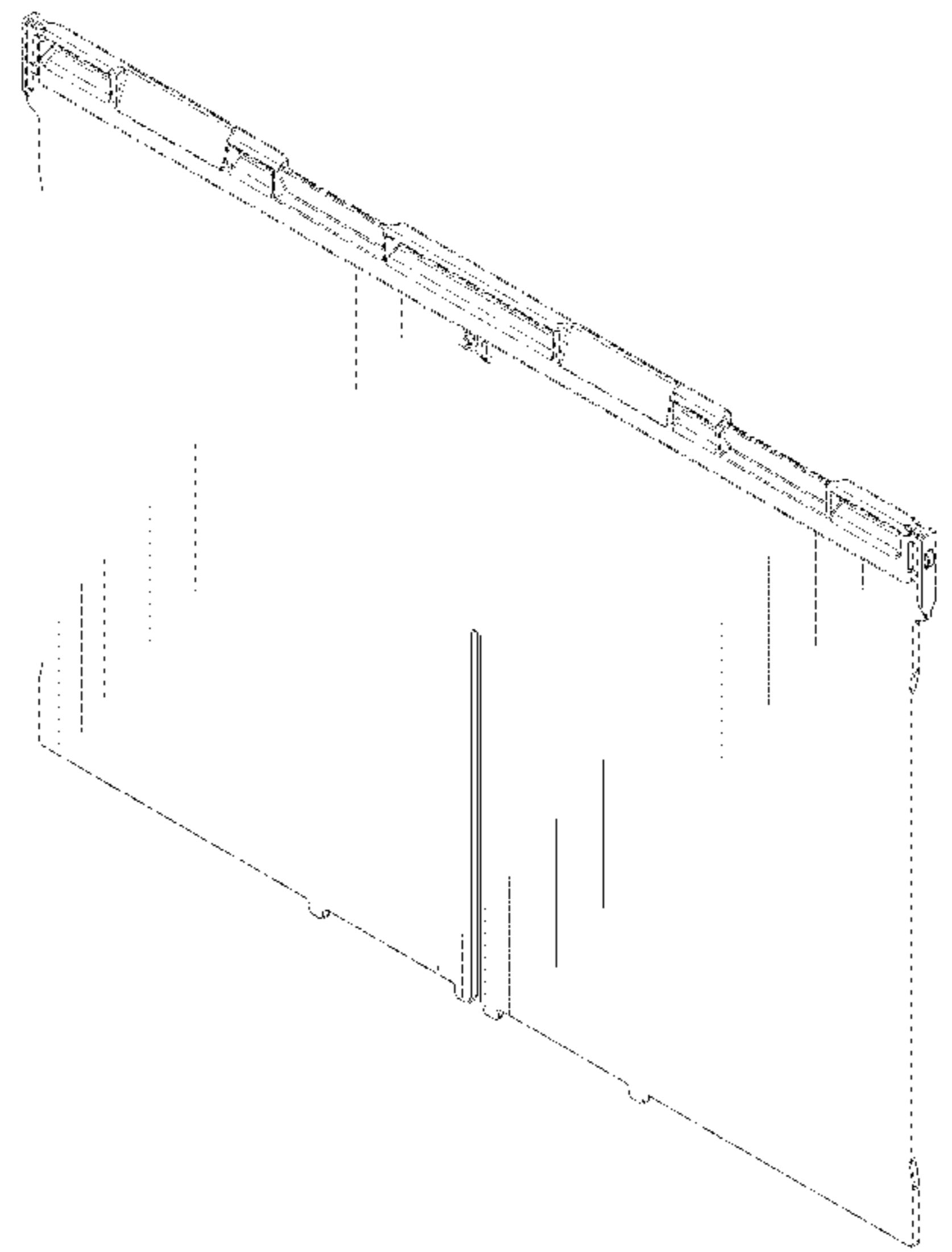

(56)

References Cited

OTHER PUBLICATIONS

Contecline divisions, posted at youtube.com, first available Sep. 9, 2020, retrieved on Jan. 5, 2023, online, <https://www.youtube.com/watch?v=g1-7f34Y5ZI> (Year: 2020).*

Sidio Crate Pro Pack, posted at amazon.com, first available Jul. 19, 2022, retrieved on Jan. 5, 2023, online, <https://www.amazon.com/SIDIO-CRATE-Pro-Pack-SidioCrate/dp/B0B6YQNJQK> (Year: 2022).*

* cited by examiner

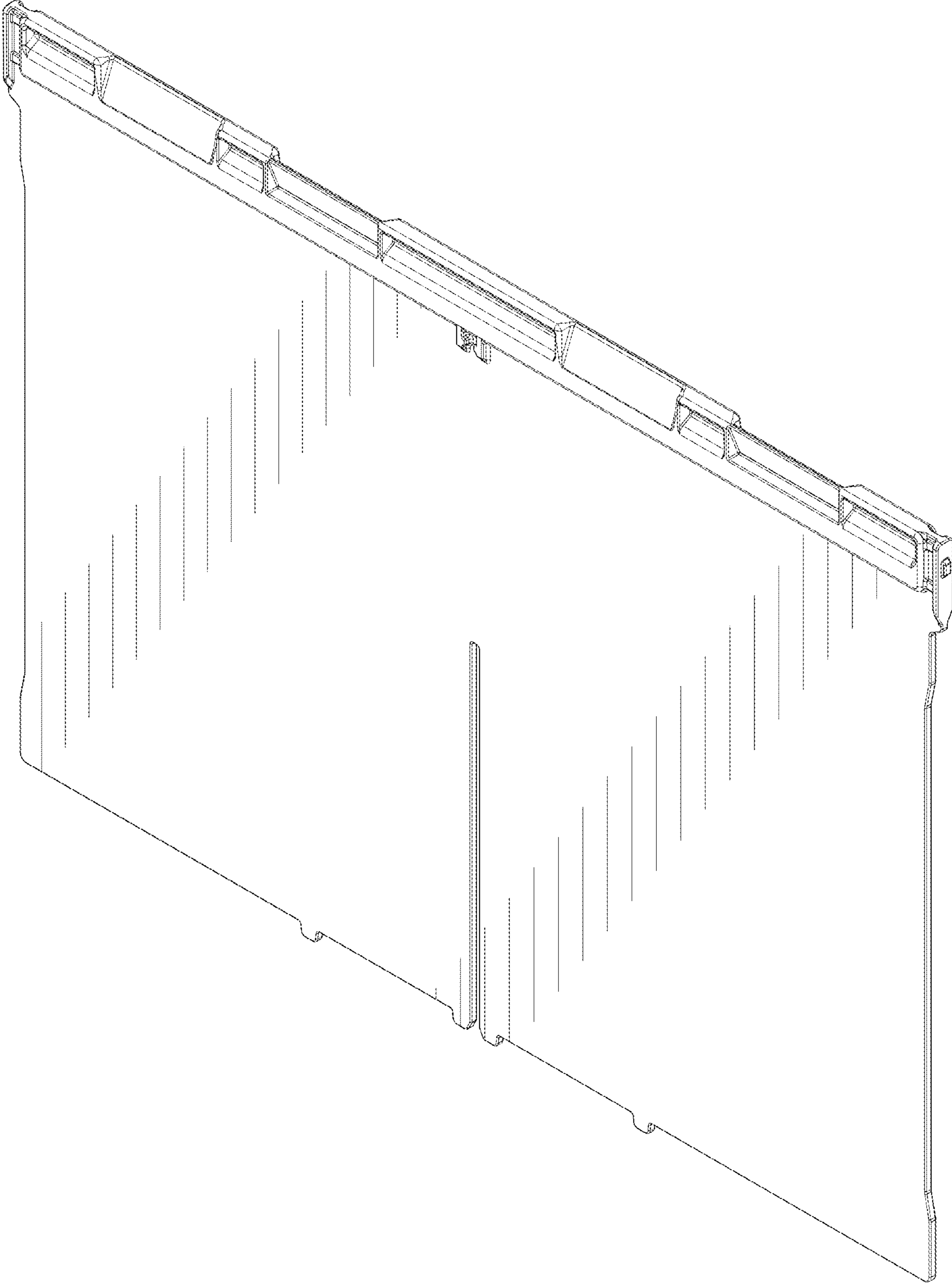

FIG. 1

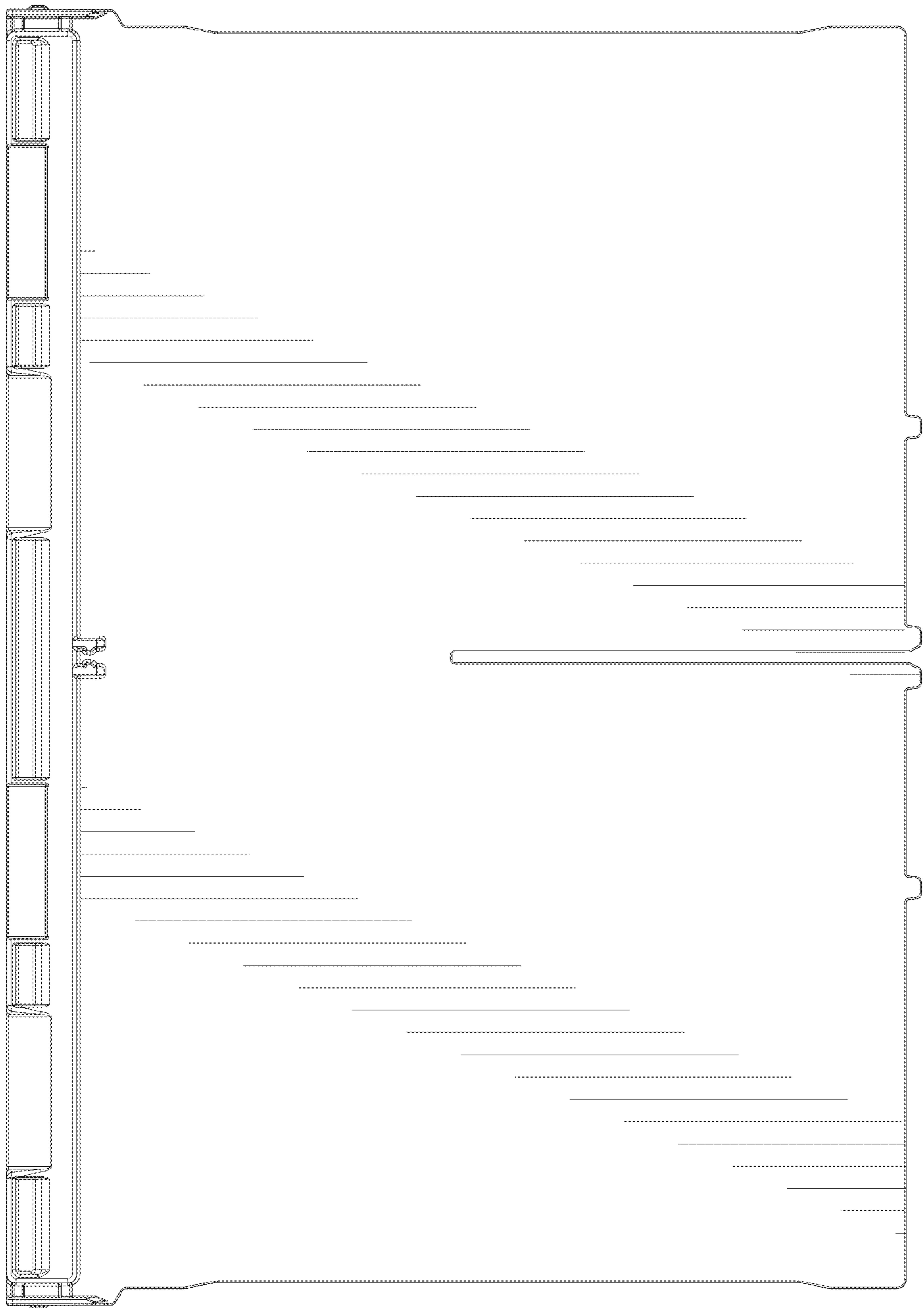

FIG. 2

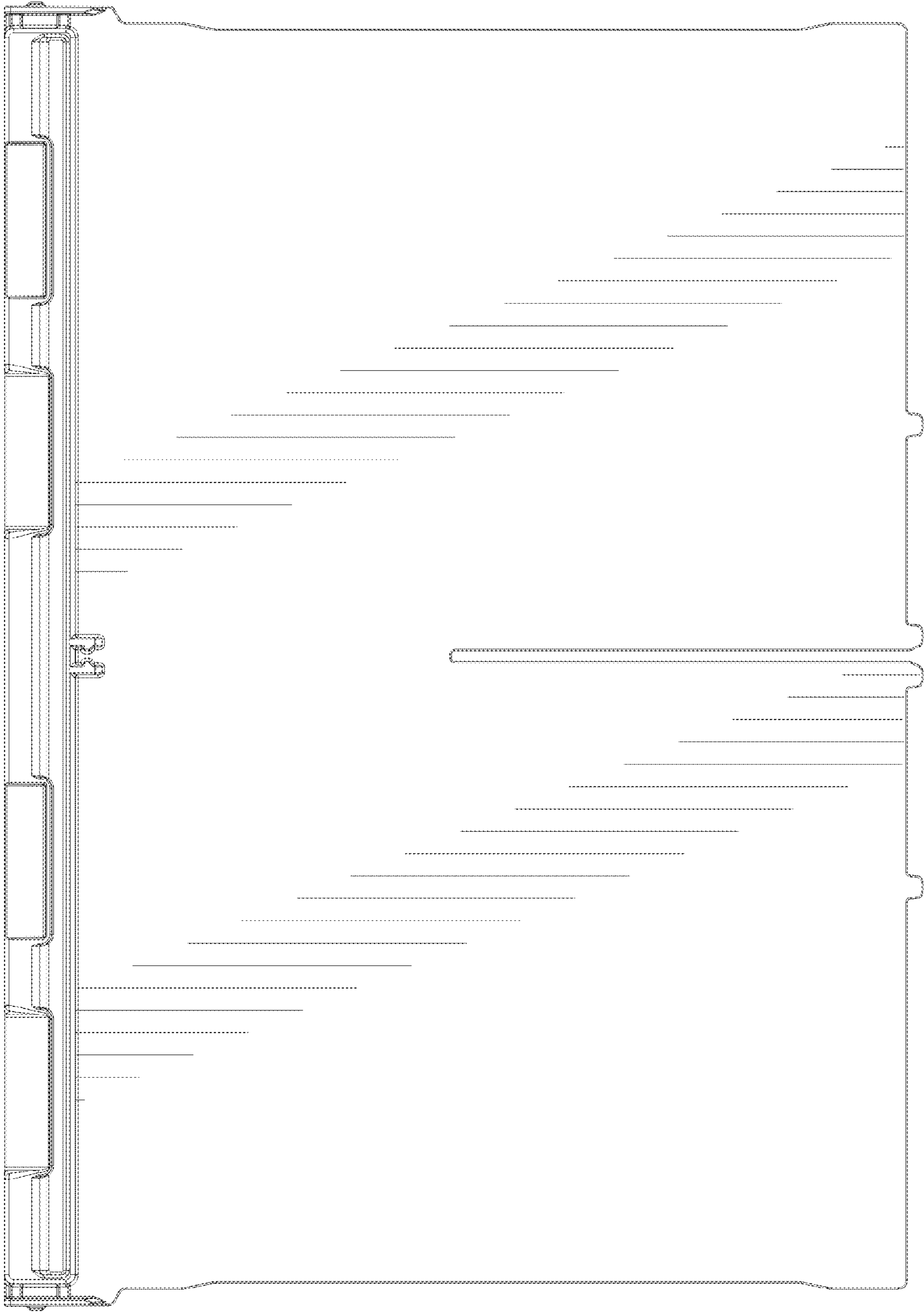

FIG. 3

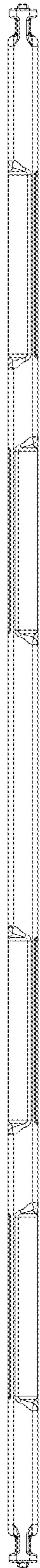

FIG. 4



FIG. 5

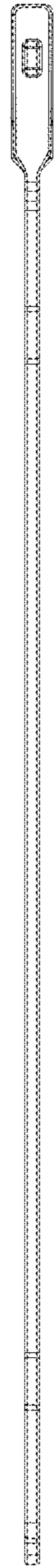

FIG. 6

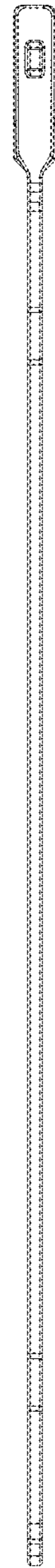

FIG. 7

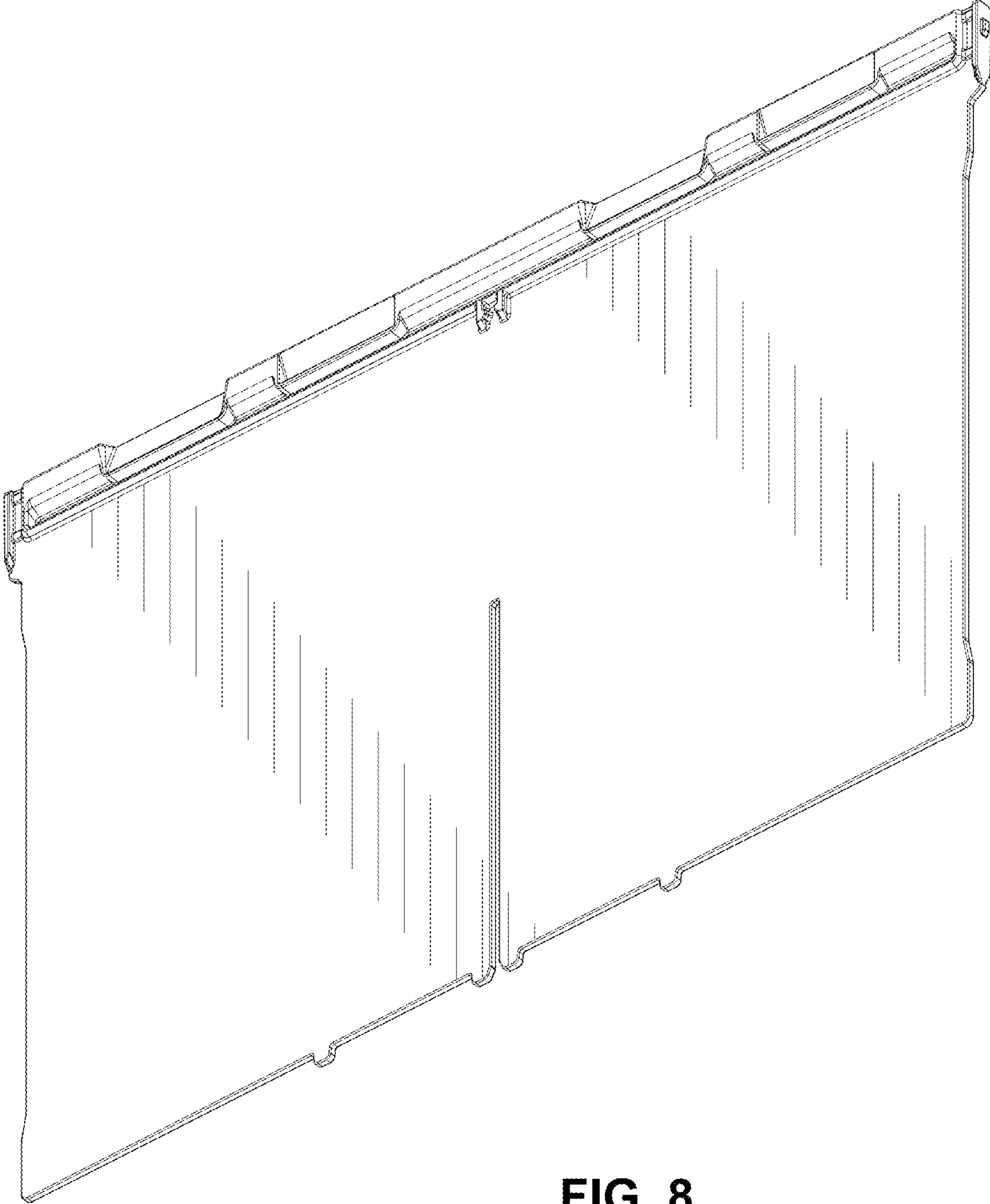

FIG. 8