



US00D982322S

(12) **United States Design Patent** (10) **Patent No.:** **US D982,322 S**  
**Sommer** (45) **Date of Patent:** **\*\* Apr. 4, 2023**

(54) **CONTAINER**

FOREIGN PATENT DOCUMENTS

(71) Applicant: **Monoflo International, Inc.**,  
Winchester, VA (US)

WO WO-D062190-001 \* 1/2003

(72) Inventor: **Axel Sommer**, Tacoma, WA (US)

OTHER PUBLICATIONS

(73) Assignee: **MONOFLO INTERNATIONAL, INC.**, Winchester, VA (US)

Bekulast Tray, posted at Bekuplast.com, first available 2022, retrieved on Jan. 5, 2023, online, <https://www.bekuplast.com/en/individual-solutions/trays-178/9668-319/> (Year: 2022).\*

(\*\*) Term: **15 Years**

Noble Products Flatware Rack, posted at webstaurantstore.com, first available Feb. 12, 2021, retrieved on Feb. 12, 2021, online, <https://www.webstaurantstore.com/noble-products-full-size-combination-flatware-rack-with-open-sides/274RKOPFLTWR.html> (Year: 2021).\*

(21) Appl. No.: **29/787,421**

Orbis Bakery Bread Tray, posted at webstaurantstore.com, first available Dec. 29, 2018, retrieved on Feb. 12, 2021, online, [https://www.webstaurantstore.com/orbis-npl660b-29-x-26-x-6-black-bakery-bread-tray-bread-rack/474NPL660.html?utm\\_source=google](https://www.webstaurantstore.com/orbis-npl660b-29-x-26-x-6-black-bakery-bread-tray-bread-rack/474NPL660.html?utm_source=google) (Year: 2018).\*

(22) Filed: **Jun. 7, 2021**

(51) **LOC (14) Cl.** ..... **09-04**

(52) **U.S. Cl.**  
USPC ..... **D3/304**

(58) **Field of Classification Search**  
USPC ..... D3/201, 245, 246, 304-309, 315, 318,  
D3/319, 323, 328; D6/675, 683;  
D9/414, 424, 425, 427, 432, 452, 456  
CPC ..... B65D 85/00; B65D 85/34; B65D 11/00;  
B65D 11/20; B65D 1/00; B65D 1/22;  
B65D 1/243; B65D 71/0003; B65D  
71/0007

\* cited by examiner

*Primary Examiner* — Barbara Fox

*Assistant Examiner* — Dustin Andrew Griffith

(74) *Attorney, Agent, or Firm* — Nixon & Vanderhye P.C.

See application file for complete search history.

(56) **References Cited**

U.S. PATENT DOCUMENTS

D224,366 S \* 7/1972 Rehrig ..... D3/312  
D249,185 S \* 8/1978 Carroll ..... D3/304  
4,106,624 A \* 8/1978 Thurman ..... B65D 21/046  
206/507  
D258,050 S \* 1/1981 Cornou ..... D3/304  
D261,444 S \* 10/1981 Munch ..... D3/312  
D319,908 S \* 9/1991 Stahl ..... D3/304  
D354,167 S \* 1/1995 Stahl ..... D3/304  
D384,975 S \* 10/1997 Jackson ..... D19/92  
D424,299 S \* 5/2000 Varfeldt ..... D3/307  
D439,049 S \* 3/2001 Koefeld ..... D3/304  
D446,939 S \* 8/2001 Koefeld ..... D3/307  
D781,148 S \* 3/2017 Kemp ..... D9/756  
2018/0251260 A1 \* 9/2018 Hassell ..... B65D 21/046

(57) **CLAIM**

The ornamental design for a container, as shown and described.

**DESCRIPTION**

FIG. 1 is a perspective view of a container showing the new design;

FIG. 2 is a front view thereof;

FIG. 3 is a rear view thereof;

FIG. 4 is a top view thereof;

FIG. 5 is a bottom view thereof;

FIG. 6 is one side view thereof;

FIG. 7 is an opposite side view thereof; and,

FIG. 8 is an alternative perspective view thereof.

**1 Claim, 6 Drawing Sheets**

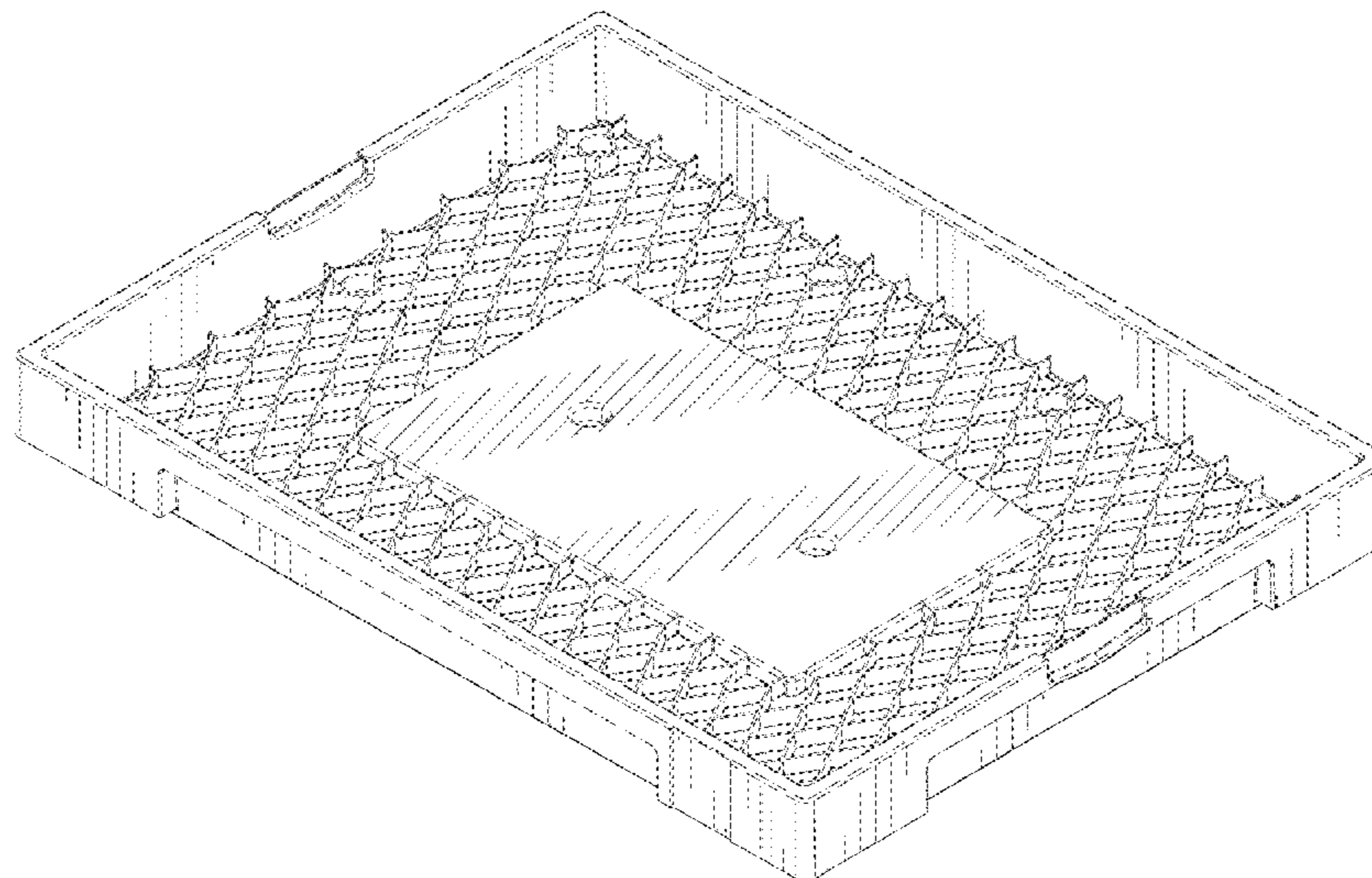

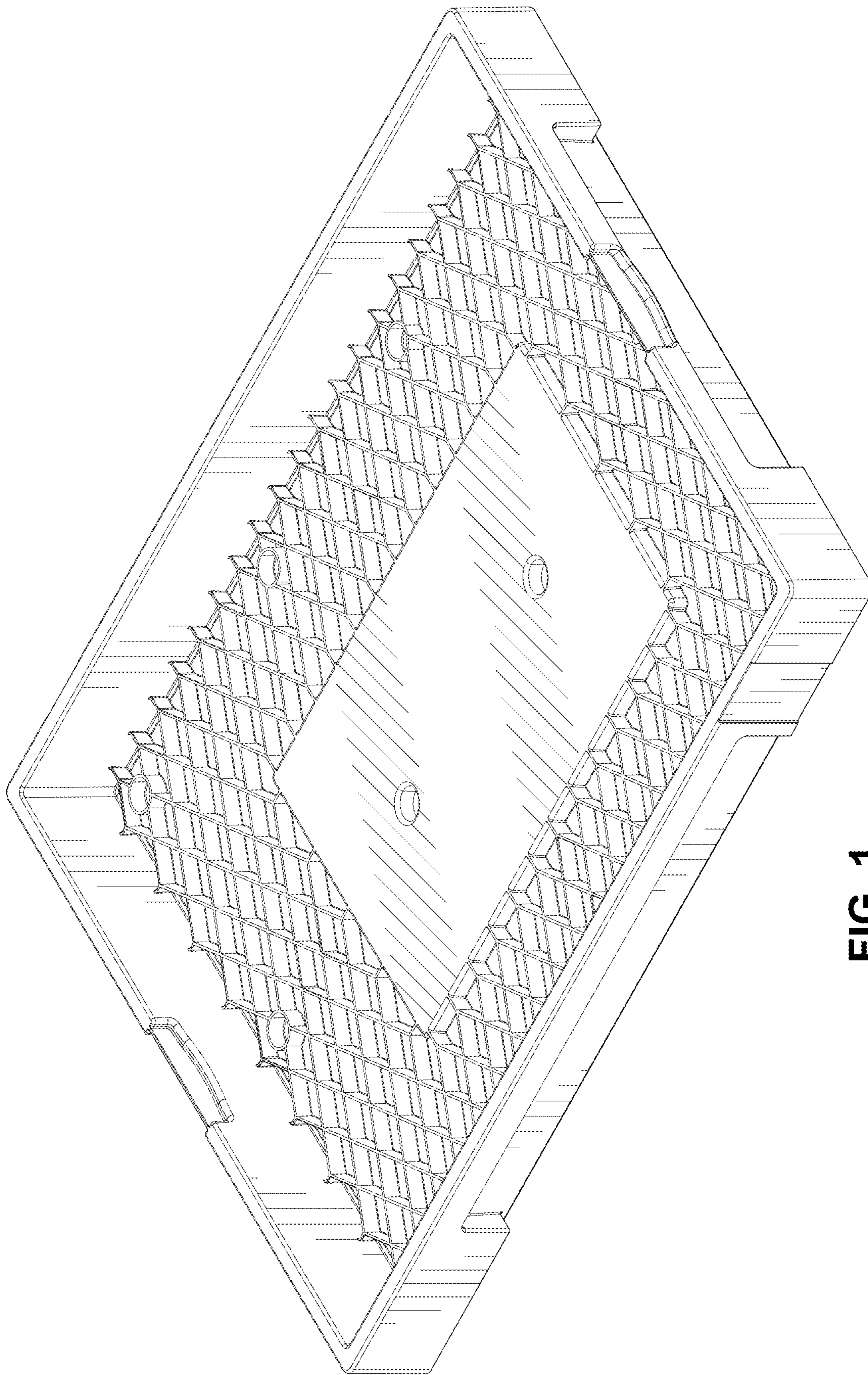

FIG. 1

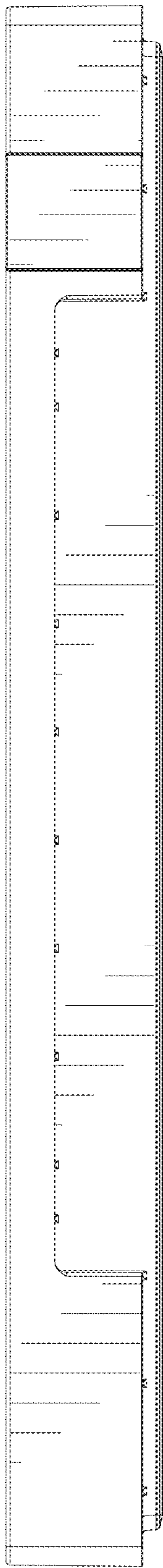

FIG. 2

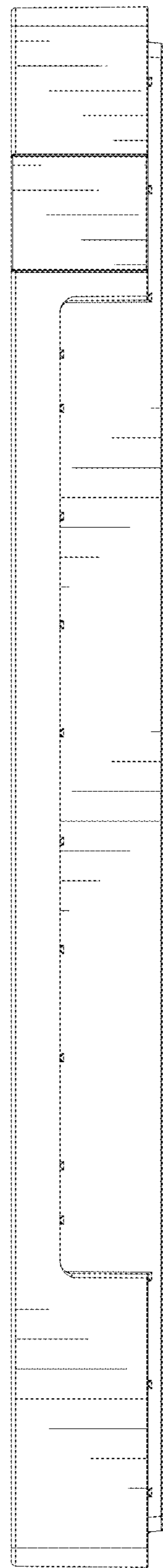

FIG. 3

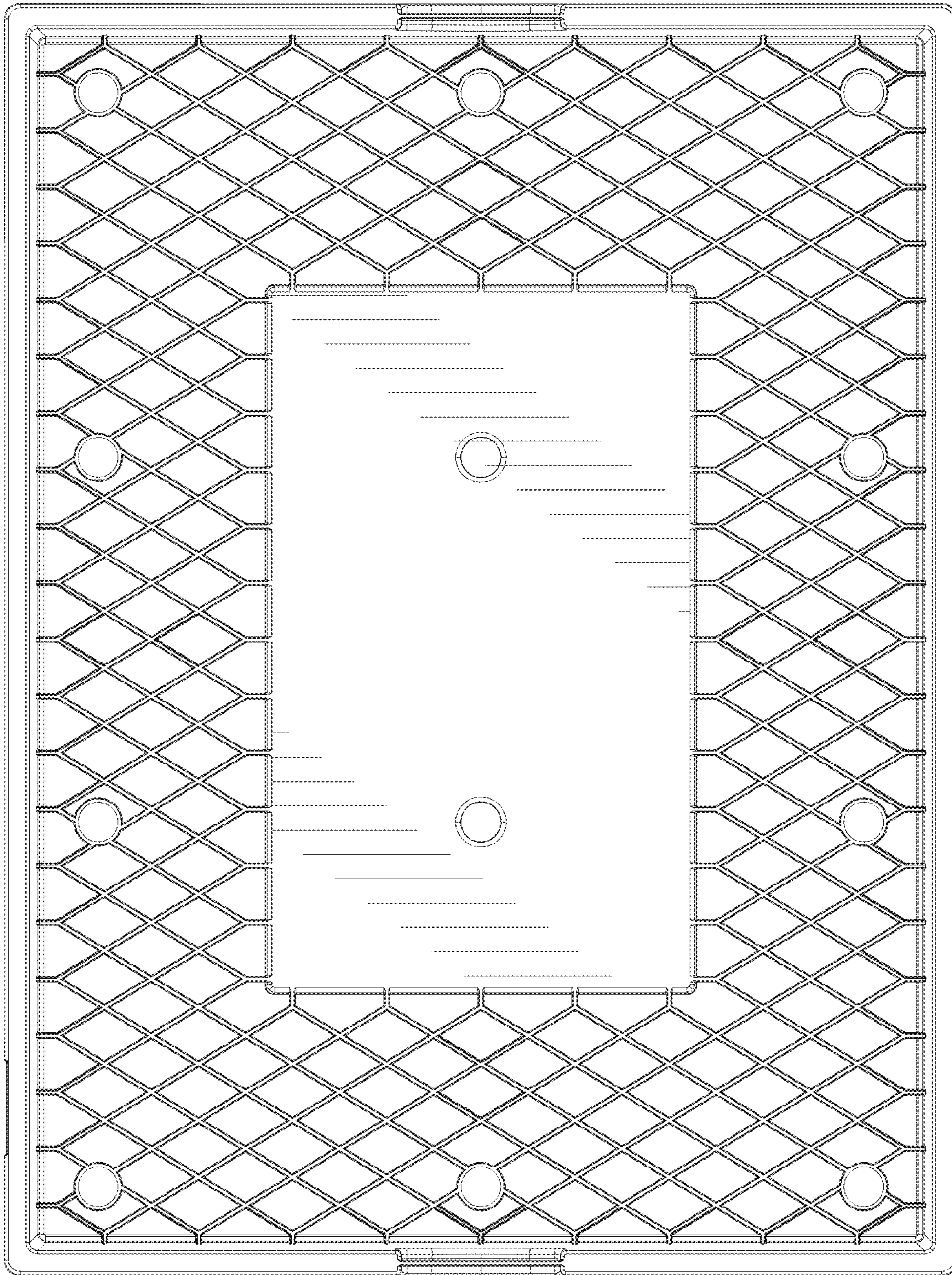

FIG. 4

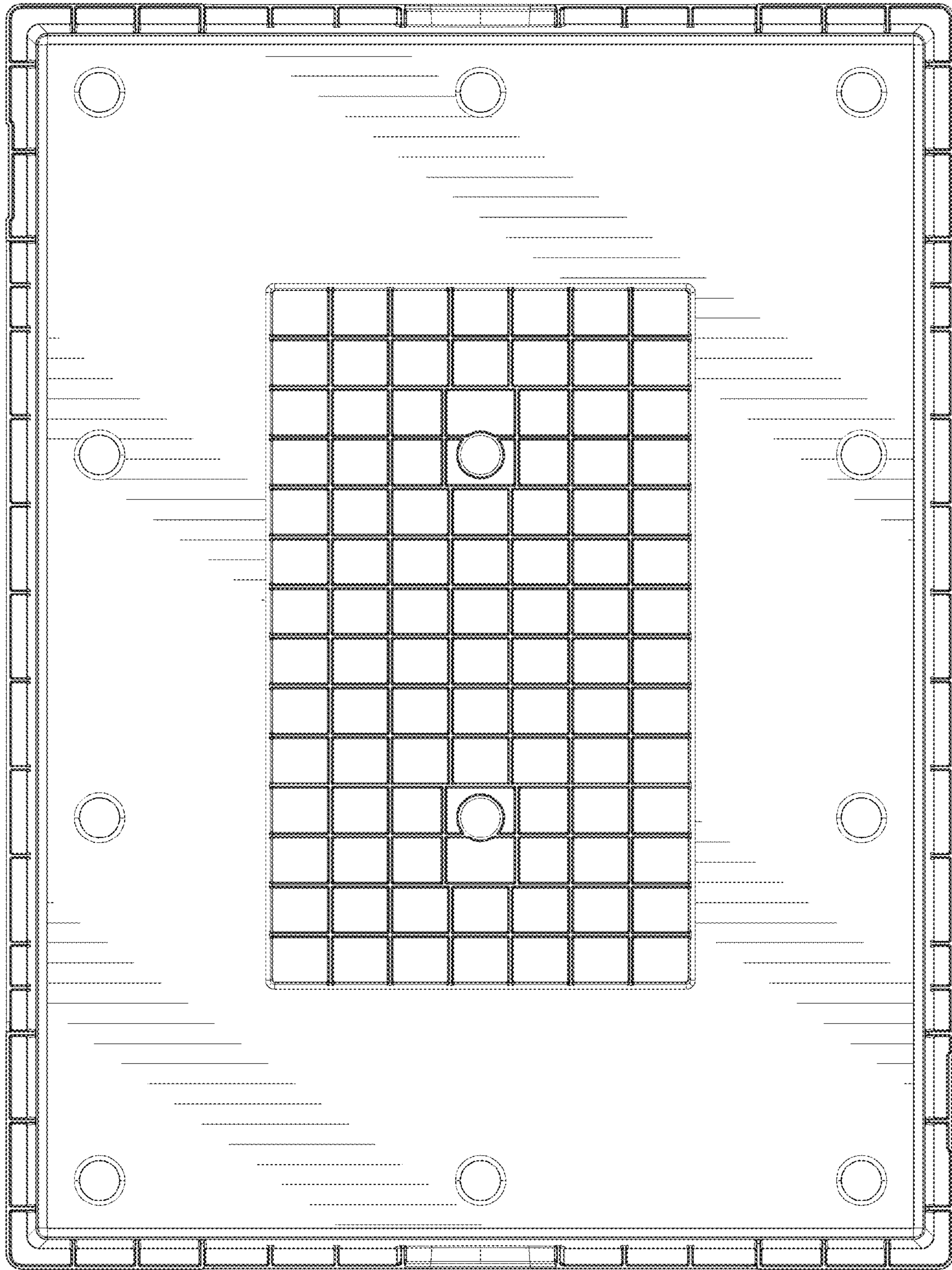
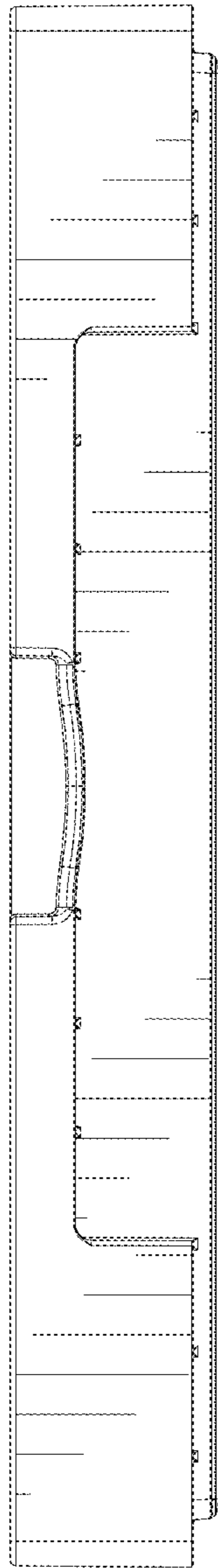
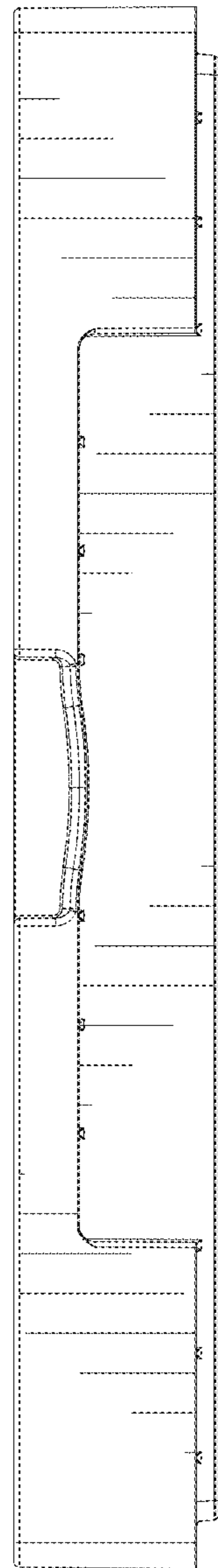

FIG. 5



**FIG. 6**



**FIG. 7**

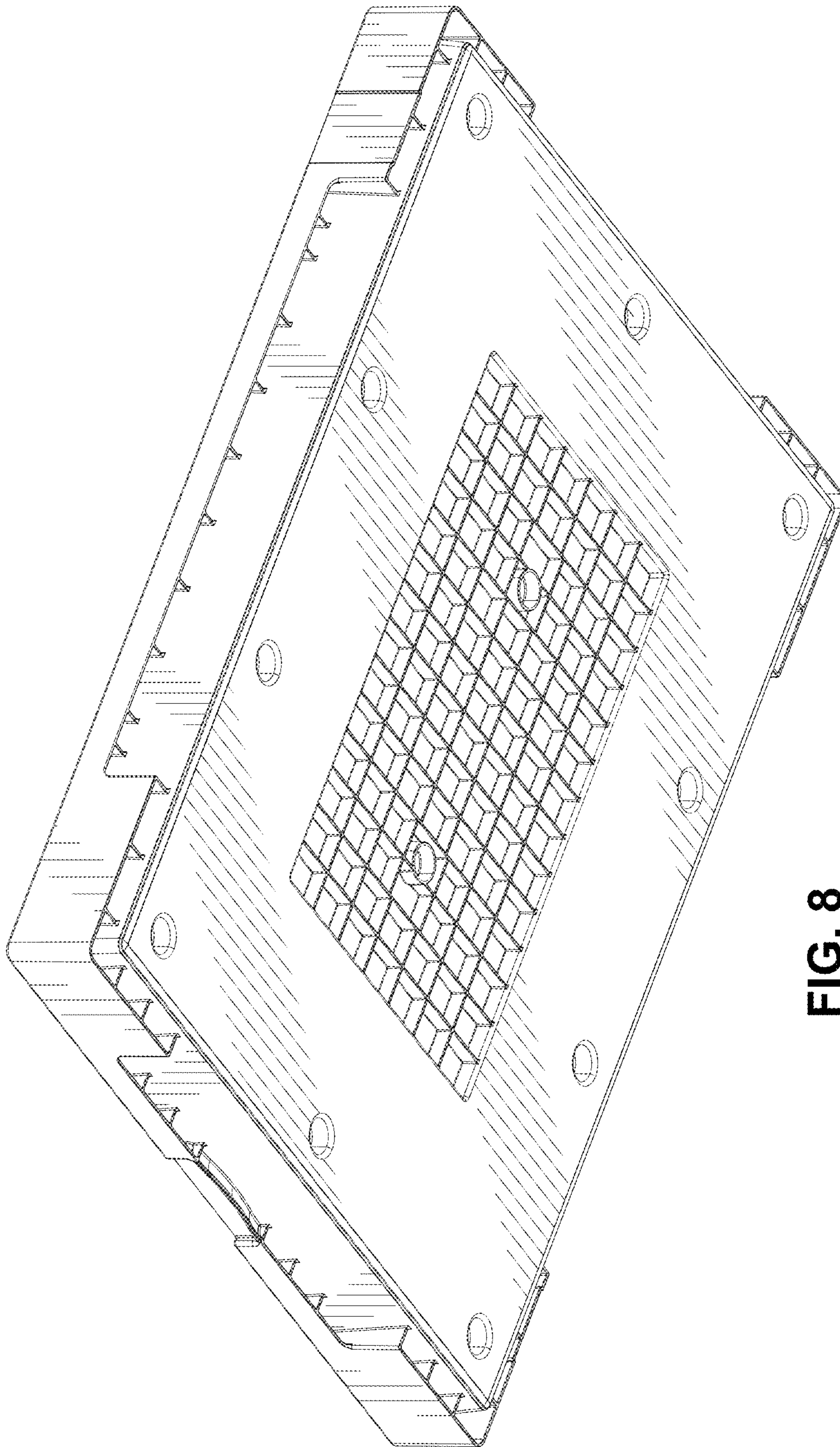

FIG. 8