



US00D982312S

(12) **United States Design Patent** (10) **Patent No.:** **US D982,312 S**
Lee (45) **Date of Patent:** **** Apr. 4, 2023**

(54) **HANDBAG**
(71) Applicant: **Bottega Veneta S.R.L.**, Montebello
Vicentino (IT)

D751,815 S * 3/2016 Pedrazzi D3/245
D759,965 S * 6/2016 Louboutin D3/246
D805,768 S * 12/2017 Nicotra D3/232
(Continued)

(72) Inventor: **Daniel Harry Lee**, Milan (IT)
(73) Assignee: **BOTTEGA VENETA S.R.L.**,
Montebello Vicentino (IT)

FOREIGN PATENT DOCUMENTS

EM 008035851-0006 * 7/2020
GB 9008035851-0006 * 7/2020
(Continued)

(**) Term: **15 Years**

OTHER PUBLICATIONS

(21) Appl. No.: **29/763,417**

“Bottega Veneta Black The Triangle Tote Bag”, first seen in Nov. 2020, modesens.com, site visited Jun. 16, 2022: <https://modesens.com/product/bottega-veneta-black-the-triangle-tote-bag-25012811/> (Year: 2020).*

(22) Filed: **Dec. 22, 2020**

(30) **Foreign Application Priority Data**

Jul. 8, 2020 (EM) 008035851-0006

(51) **LOC (14) Cl.** **03-01**

(52) **U.S. Cl.**
USPC **D3/232**

(58) **Field of Classification Search**
USPC D3/232–233, 238–239, 243, 245–246,
D3/247–253, 318
CPC A45C 3/06; A45C 3/00; A45C 3/04; A45C
11/20; A45C 13/26
See application file for complete search history.

Primary Examiner — Jennifer L Watkins
Assistant Examiner — Samantha Lynne Brodowski
(74) *Attorney, Agent, or Firm* — Fross, Zelnick, Lehrman
& Zissu PC; Charles T. J. Weigell, Esq.

(57) **CLAIM**

The ornamental design for a handbag, as shown and described.

DESCRIPTION

FIG. 1 is a perspective view of a handbag showing my new design;
FIG. 2 is a front view thereof;
FIG. 3 is a back view thereof;
FIG. 4 is a right side view thereof;
FIG. 5 is a left side view thereof;
FIG. 6 is a top view thereof; and,
FIG. 7 is a bottom view thereof.
The dash-dash broken lines illustrate portions of the handbag and form no part of the claim. The dash-dot-dash broken lines encircling the interior of the bag depict the claim boundary. The interior of the bag inside the claim boundary forms no part of the claim.

(56) **References Cited**

U.S. PATENT DOCUMENTS

3,559,873 A * 2/1971 Hart B65D 33/1683
383/34
D254,649 S * 4/1980 Felser D3/324
D257,297 S * 10/1980 Keller D8/316
D270,496 S * 9/1983 Hyers D3/246
D509,059 S * 9/2005 Hayes D3/246
D598,647 S * 8/2009 Kertesz D3/232
D626,798 S * 11/2010 Swartz D3/246
D682,053 S * 5/2013 Boroski D7/709
D751,814 S * 3/2016 Louboutin D3/232

1 Claim, 7 Drawing Sheets

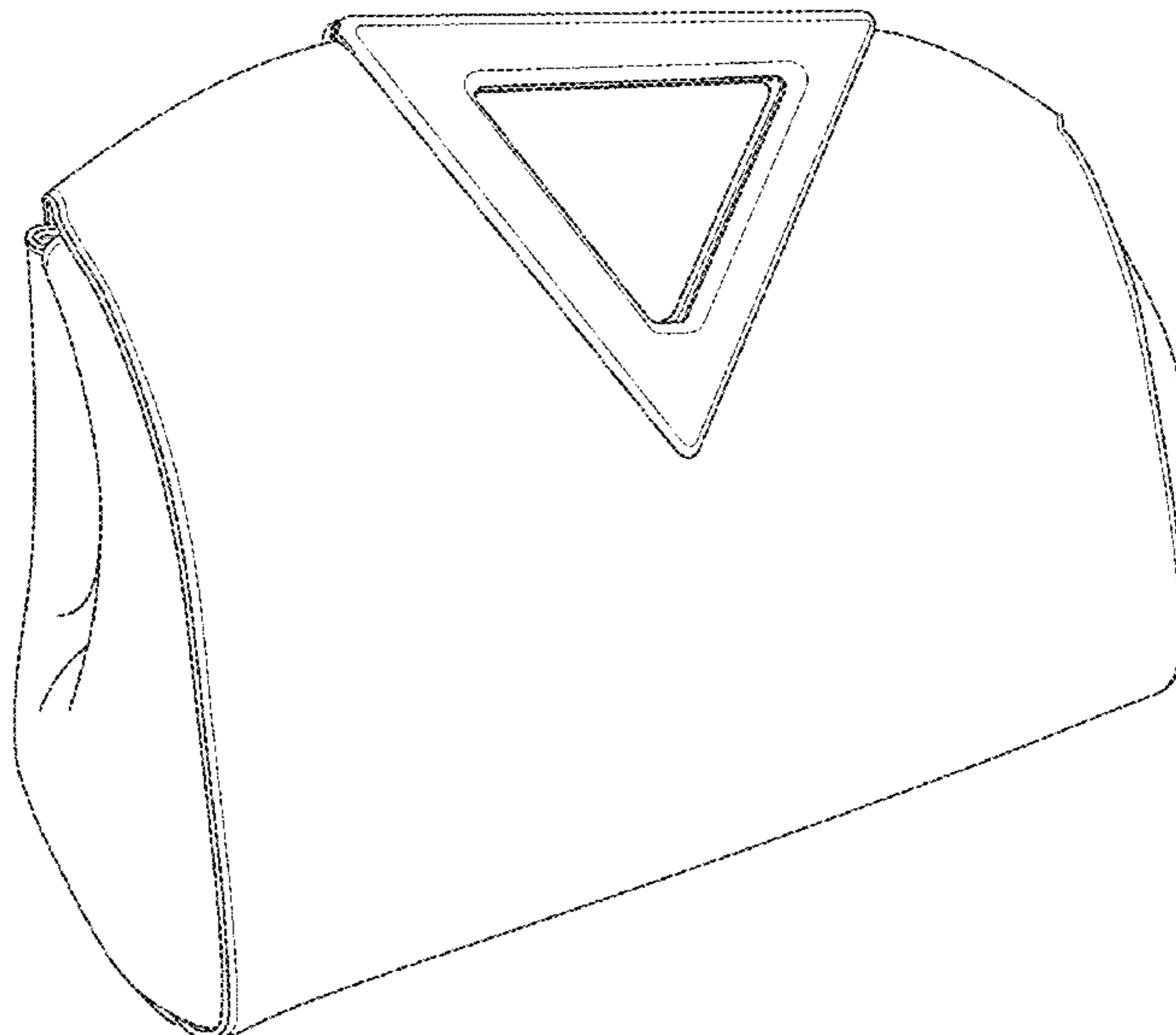

(56)

References Cited

U.S. PATENT DOCUMENTS

D808,648 S * 1/2018 Gumina D3/246
D971,596 S * 12/2022 Mattiussi D3/232

FOREIGN PATENT DOCUMENTS

HK 2017284-0001 * 12/2020
JP D1690763 * 7/2021

* cited by examiner

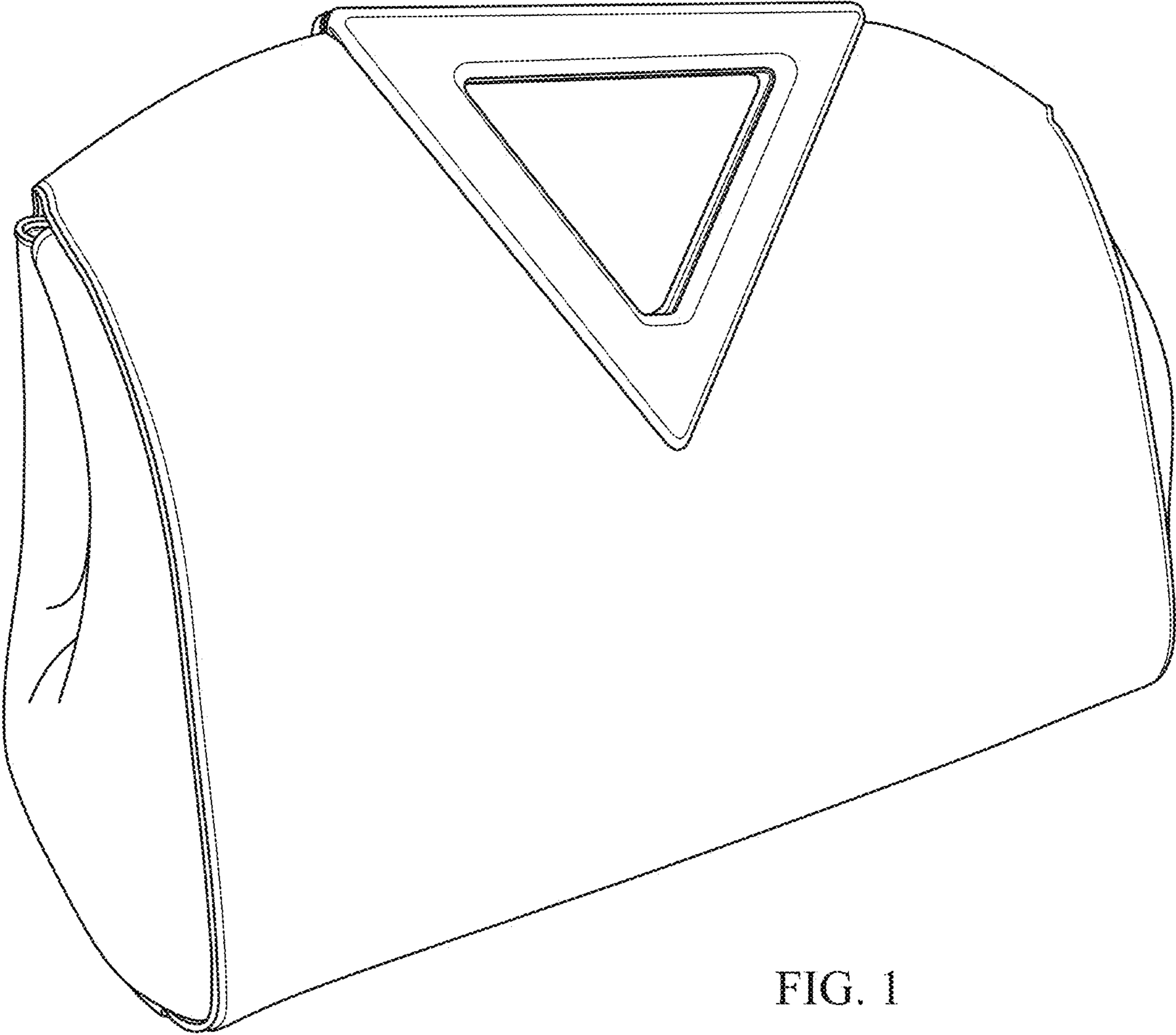

FIG. 1

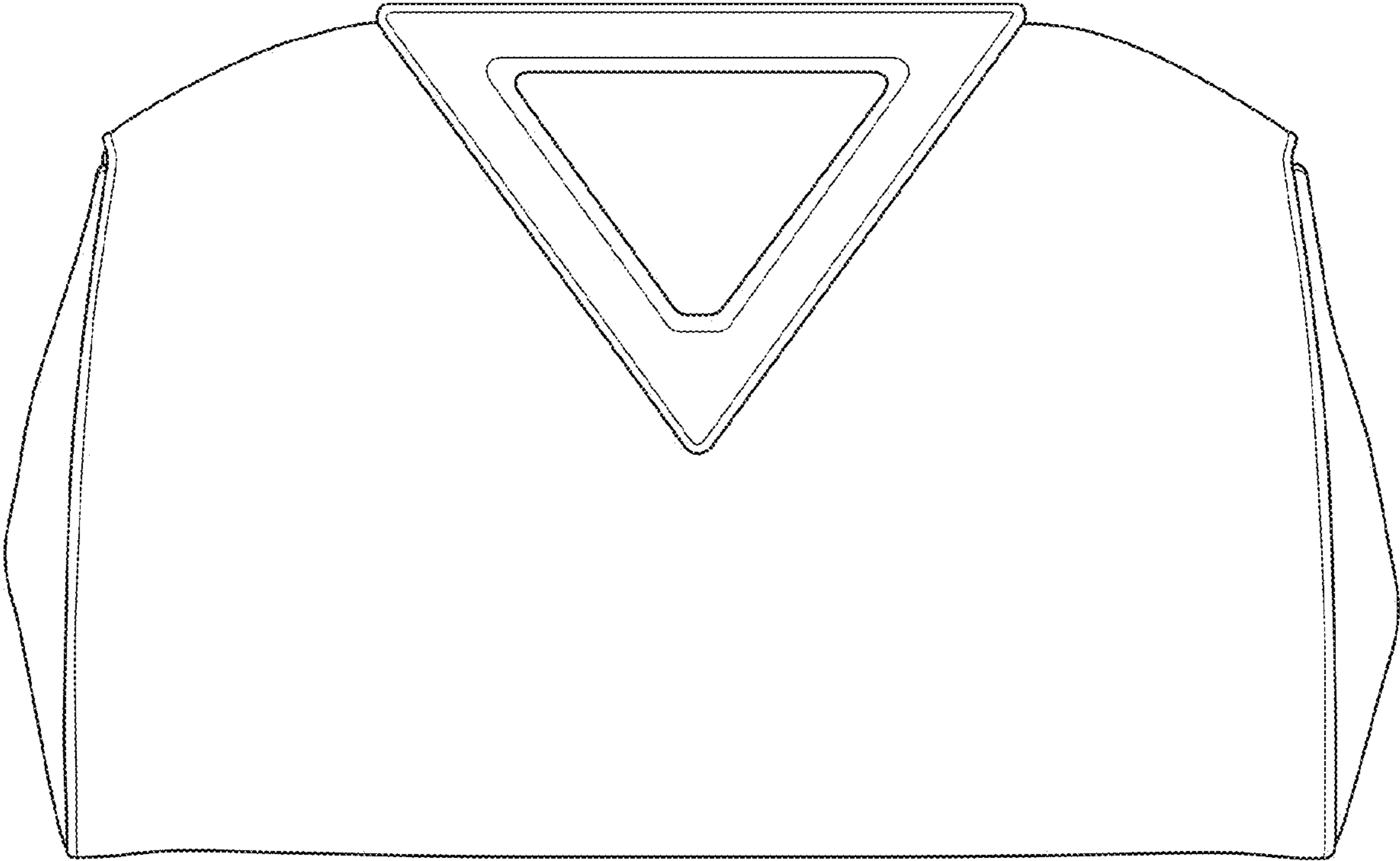

FIG. 2

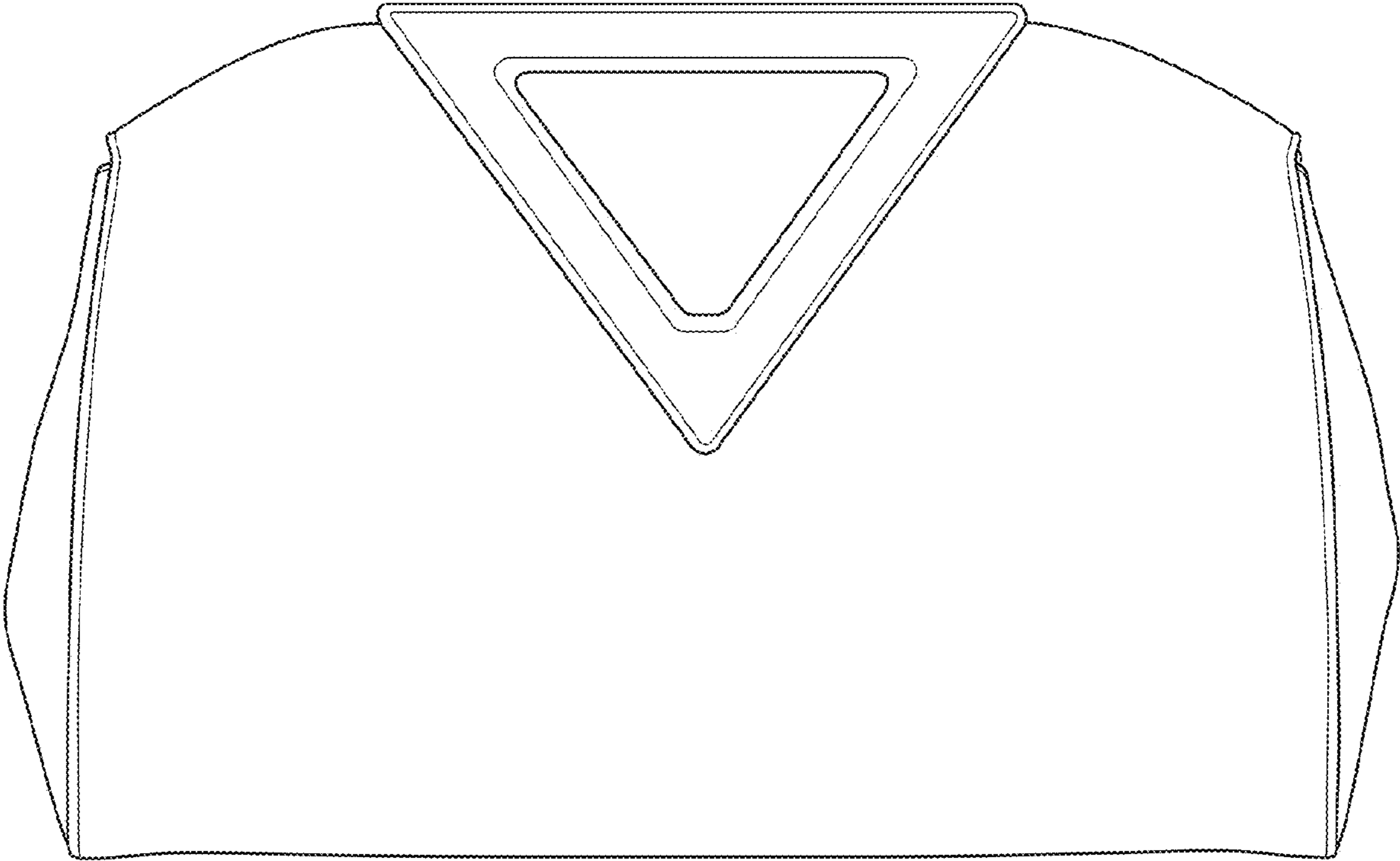

FIG. 3

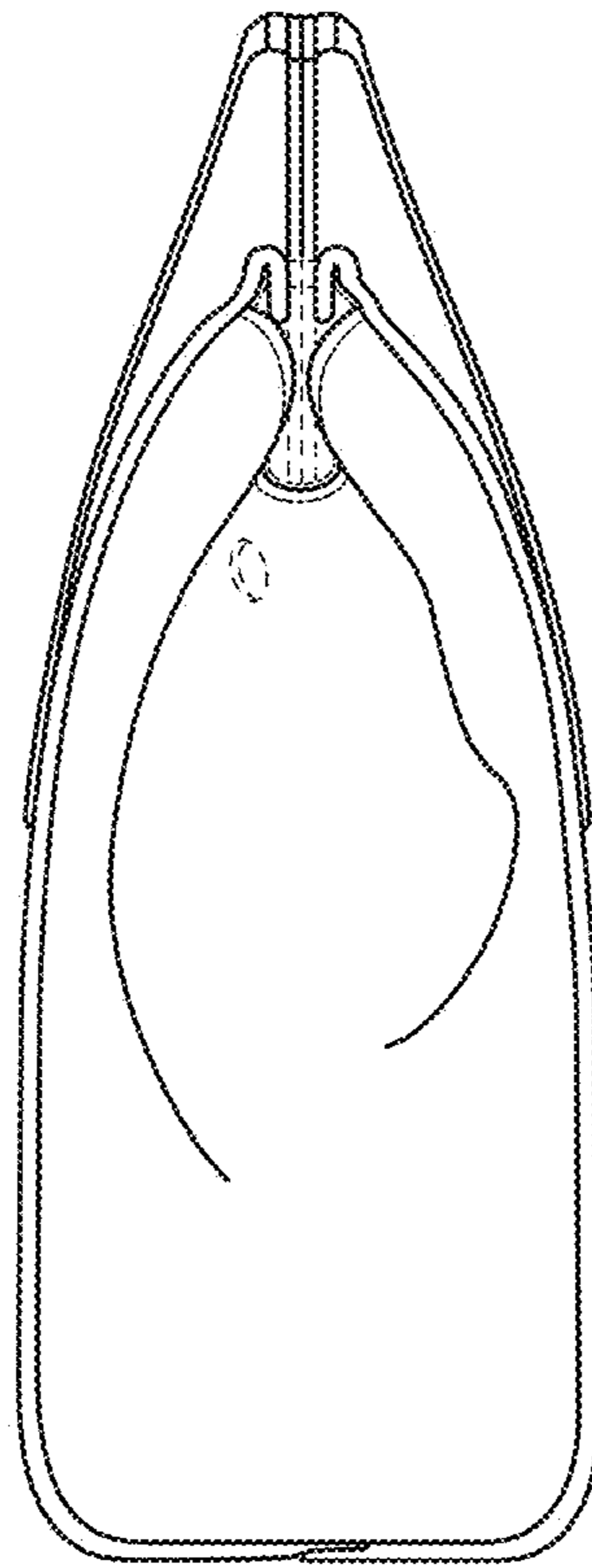

FIG. 4

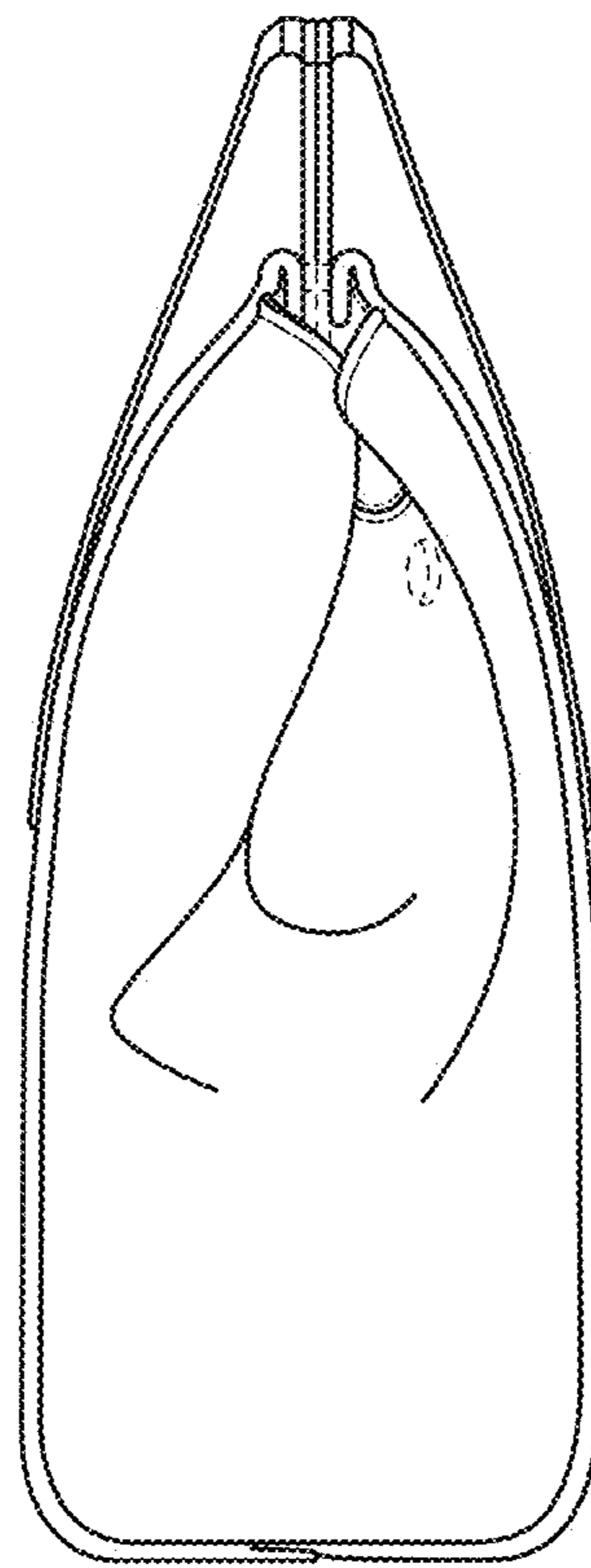

FIG. 5

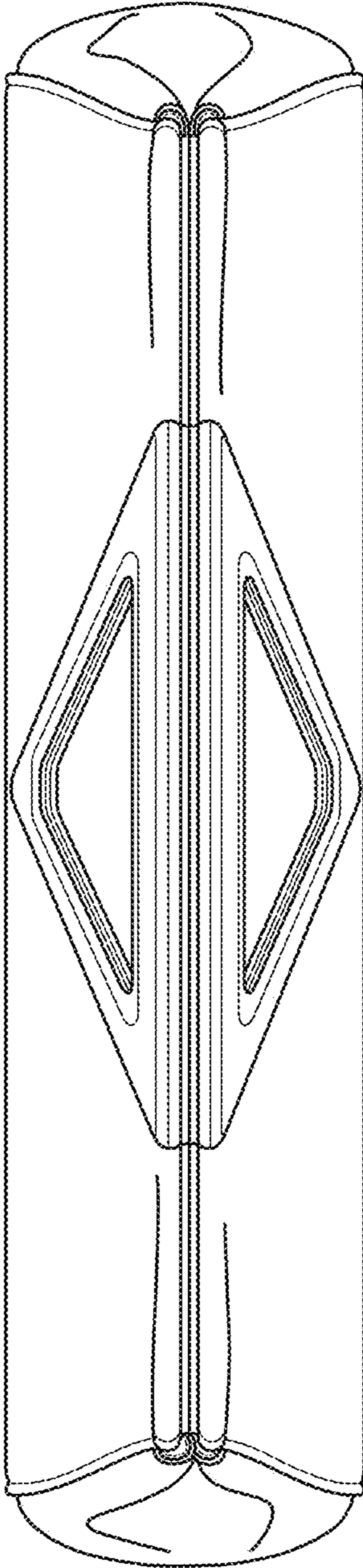

FIG. 6

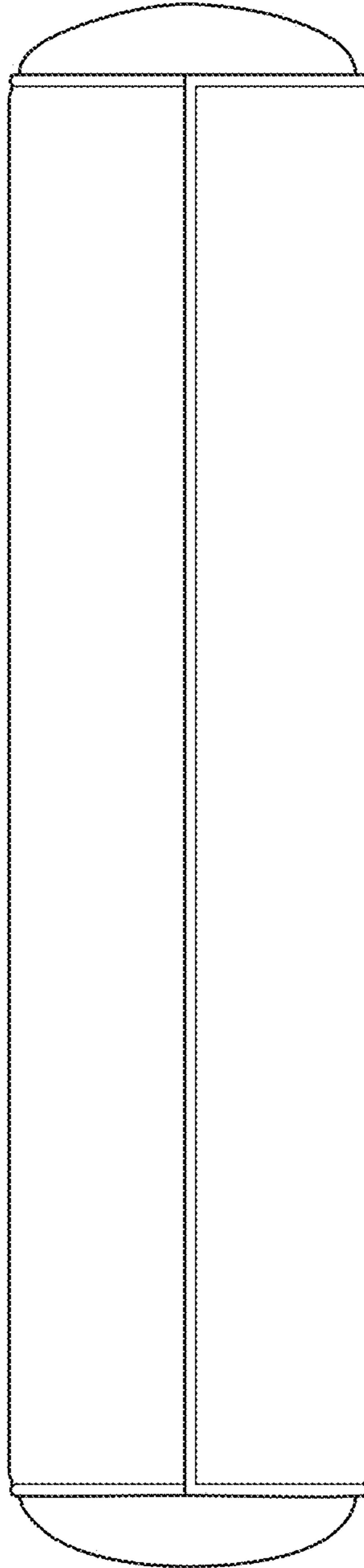

FIG. 7