



US00D982309S

(12) **United States Design Patent**
Watson

(10) **Patent No.:** **US D982,309 S**

(45) **Date of Patent:** **** Apr. 4, 2023**

(54) **PET CARRYING BACKPACK**

(71) Applicant: **K9 Sport Sack, LLC**, Lehi, UT (US)

(72) Inventor: **Joseph Watson**, Orem, UT (US)

(73) Assignee: **K9 Sport Sack, LLC**, Lehi, UT (US)

(**) Term: **15 Years**

(21) Appl. No.: **29/652,562**

(22) Filed: **Sep. 18, 2020**

(51) **LOC (14) Cl.** **03-01**

(52) **U.S. Cl.**

USPC **D3/216**

(58) **Field of Classification Search**

USPC D3/213-217, 221, 224-226, 231, 232,
D3/233, 242-244, 254, 255

See application file for complete search history.

(56) **References Cited**

U.S. PATENT DOCUMENTS

D57,526 S	4/1921	Hunt	
D111,138 S *	9/1938	Firle	D3/255
D132,469 S	5/1942	Murphy	
3,019,952 A *	2/1962	Brewster	A45F 3/04 294/142
4,018,369 A	4/1977	Jaeger	
4,318,502 A	3/1982	Lowe et al.	
4,941,603 A	7/1990	Creamer et al.	
D331,660 S *	12/1992	Souhrada	D3/255
5,176,102 A	1/1993	Tracy	

(Continued)

FOREIGN PATENT DOCUMENTS

CN	201005216 Y	1/2008
CN	202535860 U	11/2012

(Continued)

OTHER PUBLICATIONS

K9 Sport Sack Post, available at facebook.com, posted Mar. 1, 2020 [online], site visited Dec. 9, 2021, Available from the internet URL: <https://www.facebook.com/k9sportsackusa/photos/a.1908221172781963/2585534958383911/?type=3> (Year: 2020).*

(Continued)

Primary Examiner — Messina L Smith

Assistant Examiner — Jillian Mazzola

(74) *Attorney, Agent, or Firm* — TraskBritt

(57) **CLAIM**

The ornamental design for a pet carrying backpack, as shown and described.

DESCRIPTION

FIG. 1 is a perspective view of a pet carrying backpack showing the new design.

FIG. 2 is a rear view of the pet carrying backpack of FIG. 1.

FIG. 3 is a left-side view of the pet carrying backpack of FIG. 1.

FIG. 4 is a right-side view of the pet carrying backpack of FIG. 1.

FIG. 5 is a front view of the pet carrying backpack of FIG. 1.

FIG. 6 is a top view of the pet carrying backpack of FIG. 1; and,

FIG. 7 is a bottom view of the pet carrying backpack of FIG. 1.

The broken line rectangle shown in FIGS. 1-3 and 6 indicate portions of the pet carrying backpack that form no part of the claimed design. The dot-dash broken lines in FIGS. 1 and 6 depict the boundary of the claim that forms no part of the claimed design. The broken lines running adjacent to other parts shown in the design indicate stitching that forms part of the claimed design.

1 Claim, 6 Drawing Sheets

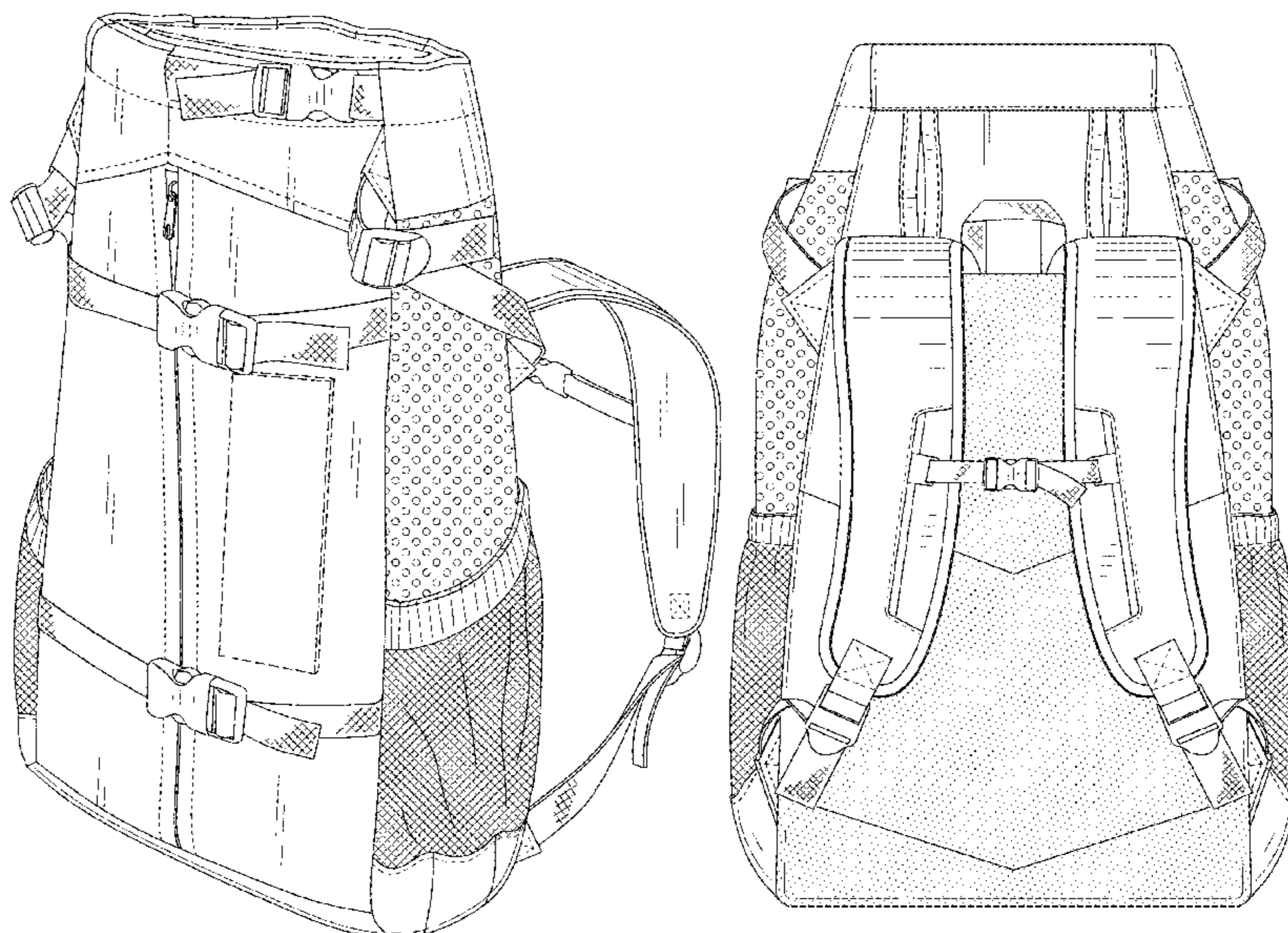

(56)

References Cited

FOREIGN PATENT DOCUMENTS

U.S. PATENT DOCUMENTS

D333,565 S 3/1993 Imbert
 D334,253 S 3/1993 Balzarini
 D340,354 S 10/1993 Wrath
 5,419,281 A 5/1995 Williams et al.
 D370,090 S 5/1996 Coggins
 D383,305 S 9/1997 Holstrom
 D392,798 S 3/1998 Gelb
 5,964,470 A 10/1999 Syendsen et al.
 6,481,606 B2 11/2002 Pickett
 6,701,871 B1 3/2004 Johnson
 D553,350 S * 10/2007 Dvorak D3/217
 D554,853 S 11/2007 Bihn
 D615,757 S 5/2010 Kostner
 D616,611 S 5/2010 Lu
 D650,576 S 12/2011 Bertken
 D664,765 S 8/2012 Saia
 D683,537 S 6/2013 Bandru
 D692,654 S 11/2013 Irwin et al.
 D710,085 S 8/2014 Szewczyk
 D734,942 S 7/2015 Robinson et al.
 D737,046 S 8/2015 Robert
 D737,568 S 9/2015 Robert
 D739,653 S 9/2015 Majeau et al.
 D745,777 S 12/2015 Zwetzig et al.
 D758,715 S 6/2016 Daniel et al.
 D771,947 S 11/2016 Tong
 D778,051 S 2/2017 Johnson
 D778,595 S 2/2017 Zurowski
 D779,823 S 2/2017 Barenbrug
 D780,454 S 3/2017 Zwetzig et al.
 D784,685 S 4/2017 Newson
 D787,815 S 5/2017 Davison
 D796,187 S 9/2017 Bogue
 D818,262 S 5/2018 Schofield
 D819,328 S 6/2018 Muhlenkamp, IV
 D822,378 S 7/2018 Franek
 D824,660 S 8/2018 Ross
 D828,112 S 9/2018 Furneaux et al.
 D829,435 S 10/2018 Viger et al.
 D849,399 S 5/2019 Christophe
 D852,492 S 7/2019 Anderson
 D858,977 S 9/2019 Owens
 D876,081 S 2/2020 Dumas
 D876,826 S * 3/2020 Watson D3/217
 10,617,096 B2 4/2020 Watson et al.
 D890,515 S 7/2020 Oviedo Polanco
 10,799,003 B2 * 10/2020 Bradley A45C 7/0077
 D904,756 S * 12/2020 Lu D3/217
 D908,975 S * 1/2021 Watson D30/109
 D909,049 S * 2/2021 Watson D3/216
 D910,243 S * 2/2021 Watson D30/109
 D915,762 S * 4/2021 Li D3/217
 D924,559 S * 7/2021 Li D3/217
 D931,600 S 9/2021 Huang
 D942,142 S 2/2022 Mandos
 2002/0074372 A1 6/2002 Pickett
 2002/0108982 A1 8/2002 Mydans
 2003/0205601 A1 11/2003 Kilduff
 2007/0017947 A1 1/2007 Fenton et al.
 2008/0066689 A1 * 3/2008 Martz A01K 1/0254
 119/497
 2008/0149673 A1 6/2008 Slater
 2008/0216764 A1 9/2008 Porter
 2011/0083933 A1 4/2011 Engel
 2013/0221051 A1 * 8/2013 Hairston B32B 37/14
 224/633
 2014/0060453 A1 3/2014 Shewfelt
 2017/0172102 A1 6/2017 Rivera
 2018/0139921 A1 5/2018 Kath
 2018/0139922 A1 5/2018 Watson et al.
 2018/0154203 A1 * 6/2018 Schromm A45F 3/04
 2018/0228120 A1 8/2018 Laicheng
 2020/0060222 A1 2/2020 Watson
 2022/0061263 A1 3/2022 Watson

CN 303221063 5/2015
 CN 303342928 8/2015
 CN 304021795 * 2/2017
 CN 305122160 * 4/2019
 CN 306365217 * 3/2021
 EM 000042999-0004 * 10/2003
 EM 006395372-0001 4/2019
 EM 006395372-0002 * 6/2019
 GB 6016752 8/2017
 GB 9006395372-0002 4/2019
 GB 6128720 4/2021
 JP H05-046264 U 6/1993
 JP 2000-287574 A 10/2000
 JP D1609184 S 7/2018
 JP D1621362 S 1/2019
 KR 20-0335245 Y1 12/2003
 KR 10-1525981 B1 6/2015
 KR 300823841.0000 11/2015
 KR 10-2019-0056722 A 5/2019
 KR 301136355-0000 11/2021
 RU 00084313 * 2/2013
 RU 00127653 9/2021
 SG 20141329F-0001 * 11/2014
 TW D180162 S 12/2016
 TW D182034 S 4/2017
 TW D190435 S 5/2018
 TW D194326 S 12/2018
 WO WO 1997/037529 A1 10/1997
 WO WO 2008/153252 A1 12/2008
 WO WO 2016/096150 A1 6/2016

OTHER PUBLICATIONS

K9 Sport Sack Post, available at facebook.com, posted Jun. 1, 2018 [online], site visited Dec. 9, 2021, Available from the internet URL: <https://www.facebook.com/k9sportsackusa/photos/a.1606811192922964/2095610264043052/?type=3> (Year: 2018).*

Herkey the Cavalier's K9 Sport Sack Adventure 2019, available at youtube.com, posted Apr. 25, 2019 [online], site visited Dec. 9, 2021, Available from the internet URL: <https://www.youtube.com/watch?v=wxGILs-DsiE> (Year: 2019).*

Pets Carrier Backpack, available at nxills.com, date not available [online], site visited Dec. 9, 2021, Available from the internet URL: https://www.nxills.com/index.php?main_page=product_info&products_id=794974.*

Kurgo G-Train Backpack, available at chewy.com, earliest customer review date May 14, 2019 [online], site visited Dec. 9, 2021, Available from the internet URL: <https://www.chewy.com/kurgo-g-train-airline-approved-dog/dp/190589?> (Year: 2019).*

Woyyho Pet Dog Carrier Backpack, available at amazon.com, earliest date available Oct. 17, 2020 [online], site visited Dec. 9, 2021, Available from the internet URL: <https://www.amazon.com/dp/B08L7RFYXG?tag=upgrapoint-20&linkCode=ogi&th=1> (Year: 2020).*

Amazon, "K9 Sport Sack 1 Dog Carrier Backpack for Small and Medium Pets . . .", First review Jan. 4, 2016. (<https://www.amazon.com/dp/B07HZ6BVQ4?th=1>) (Year: 2016).

K9 Sport Sack: Because Dogs Just Wanna to Have Fun! posted at missmollysays.com, posted on Feb. 26, 2017, online, URL: <https://missmollysays.com/k9-sport-sack-because-dogs-just-wanna-have-fun/> (Year: 2017).

K9 Sport Sack, posted at www.bonesps.com, no posting date available, online, URL: <https://www.bonesps.com/collections/vendors?q=K9%20Sport%20Sack> (Year: 2018).

JPO Ref. No. HB08021181, Outside, 9th, vol. 21, p. 150, Sep. 30, 1996, 1 page.

JPO Ref. No. HH13021686, S Design Gazette (DE), Nov. 10, 2000, 1 page.

JPO Ref. No. HA13021582, Tokusengai, 1st, vol. 24, p. 175, Jan. 1, 2002, 1 page.

JPO Ref. No. HC14042642, General Catalog, E-Motion, p. 28, JPO documented on Sep. 27, 2002, 1 page.

(56)

References Cited

OTHER PUBLICATIONS

JPO Ref. No. HC15040837, Adventure Travel, The North Face Catalog Fall & Winter 2003-2004, p. 53, JPO documented on Oct. 24, 2003, 1 page.

JPO Notification of List of References for JP Design Registration Application No. 2018-020511.

International Search Report dated Mar. 12, 2018, in corresponding Application No. PCT/US2017/063130.

Ytonet Pet Carrier Bbackpack, available at amazon.com, earliest date available Nov. 30, 2018 [online], site visited Dec. 9, 2021, Available from the internet URL: <https://www.amazon.com/dp/B07FY4561Q?th=1> (Year: 2018).

K9 Sport Sack Evolution, available at youtube.com, posted May 22, 2020 [online], site visited Dec. 9, 2021, Available from the internet URL: <https://www.youtube.com/watch?v=zGWK70RMVQM> (Year: 2020).

Backpack, walmart.com, date not available [online], site visited Dec. 9, 2021, Available from the internet URL: <https://www.walmart.com/ip/Anself-Pet-Backpack-Dog-Cat-Carrier-Double-Zip-Clear-Window-Side-Pockets-Travel-Shoulder-Bag-Open-Doors-Comfortable-Travelling-Hiking-Outdoor-Use/397323749>.

K9 Sport Sack Air 2, available at k9sportsack.com, earliest customer review date Feb. 24, 2020 [online], site visited Dec. 9, 2021, Available from the internet URL: <https://www.k9sportsack.com/products/air-2> (Year: 2020).

K9 Sport Sack Post, available at facebook.com, posted Sep. 3, 2019 [online], site visited Dec. 9, 2021, Available from the internet URL: <https://www.facebook.com/k9sportsackusa/photos/a.1908221172781963/2427074830896592/?type=3> (Year: 2019).

K9 Sport Sack Trainer, available at amazon.com, earliest customer question date Dec. 1, 2019 [online], site visited Dec. 9, 2021, Available from the internet URL: <https://www.amazon.com/K9-Sport-Sack-Adjustable-Veterinarian/dp/B07XYK9N3G?th=1> (Year: 2019).

PawRoll Dog Carrier Backpack, available at pawroll.com, earliest customer review date Jan. 26, 2018 [online], site visited Dec. 9, 2021, Available from the internet URL: <https://pawroll.com/products/pawroll-dog-backpack-carrier/> (Year: 2018).

K9 Sport Sack Trainer, available at k9sportsack.com, earliest customer review date Jan. 2, 2020 [online], site visited Dec. 9, 2021, Available from the internet URL: <https://www.k9sportsack.com/products/k9-sport-sack-trainer> (Year: 2020).

Outward Hound Carrier, available at amazon.com, earliest date available Apr. 30, 2012 [online], site visited Dec. 9, 2021, Available from the internet URL: <https://www.amazon.com/Outward-Hound-Pooch-Pouch-Carrier-Backpack/dp/80081XIJ9M?> (Year: 2012).

K9 Sport Sack Air Trainer, available at petco.com, date not available [online], site visited Dec. 9, 2021, Available from the internet URL: <https://www.petco.com/shop/en/petcostore/product/k9-sport-sack-air-trainer-greenbackpack-pet-carrier-12-1-x-11-w-x-22-h-3161467?>

K9 Sport Sack: Unique Dog Transportation Bag, available at www.kickstarter.com, posted Apr. 26, 2013 [online], available from the Internet URL: <https://www.kickstarter.com/projects/1034052737/k9-sport-sack-unique-dog-transportation-bag?ref=discovery&term=k9%20sport%20sack>.

K9 Sport Sack Knavigate, available at k9sportsack.com, earliest customer review date Dec. 15, 2020 [online], site visited Dec. 9, 2021, Available from the internet URL: <https://www.k9sportsack.com/products/k9-sport-sack-knavigate> (Year: 2020).

K9 Sport Sack Post, available at facebook.com, posted Dec. 29, 2018 [online], site visited Dec. 9, 2021, Available from the internet URL: <https://www.facebook.com/k9sportsackusa/photos/a.1908221172781963/2262498034020940/?type=3> (Year: 2018).

The All New Knavigate, available at youtube.com, posted Dec. 1, 2020 [online], site visited Dec. 9, 2021, Available from the internet URL: <https://www.youtube.com/watch?v=hfKOryG2z4o> (Year: 2020).

WLDOCA Dog Carrier Backpack, available at amazon.com, earliest date available Mar. 14, 2019 [online], site visited Dec. 9, 2021, Available from the internet URL: <https://www.amazon.com/WLDOCA-Carrier-Backpack-Adjustable-Motorcycle/dp/B08KVXPTHR?th=1> (Year: 2019).

Tirrinia Large Pet Backpack, available at amazon.com, earliest date available Nov. 30, 2018 [online], site visited Dec. 9, 2021, Available from the internet URL: <https://www.amazon.com/gp/product/B0797DGZ38?th=1> (Year: 2018).

Ruffit Dog Carrier, available at amazon.com, earliest customer review Dec. 12, 2017 [online], site visited Apr. 20, 2022.

International Search Report for International Application No. PCT/US2021/048299 dated Nov. 29, 2021, 10 pages.

International Search Report dated Dec. 4, 2019 in corresponding Application No. PCT/US2019/047562.

Extended European Search Report dated Jun. 10, 2020; in EP Application No. 17874238.3 filed Nov. 22, 2017, 9 pages.

* cited by examiner

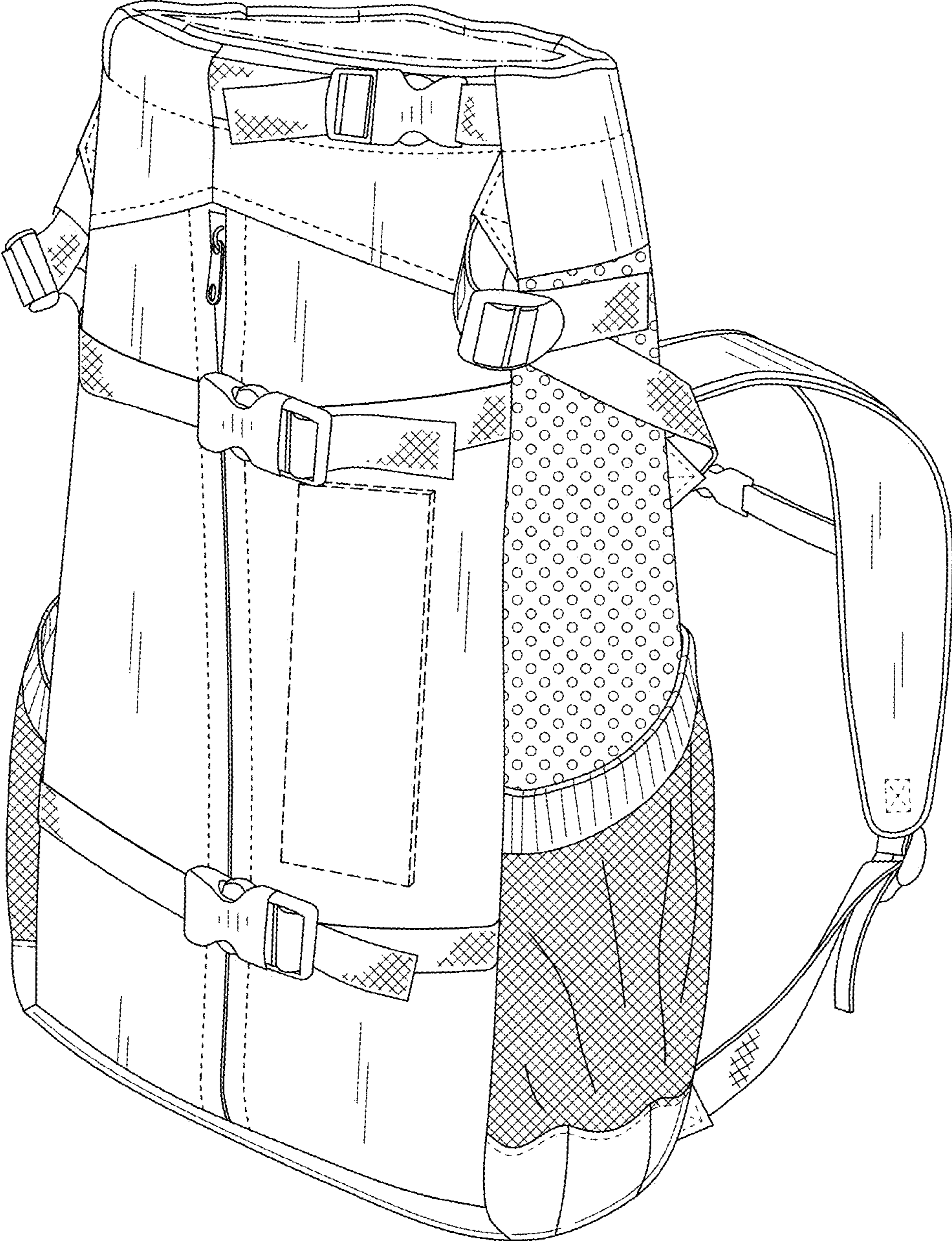

FIG. 1

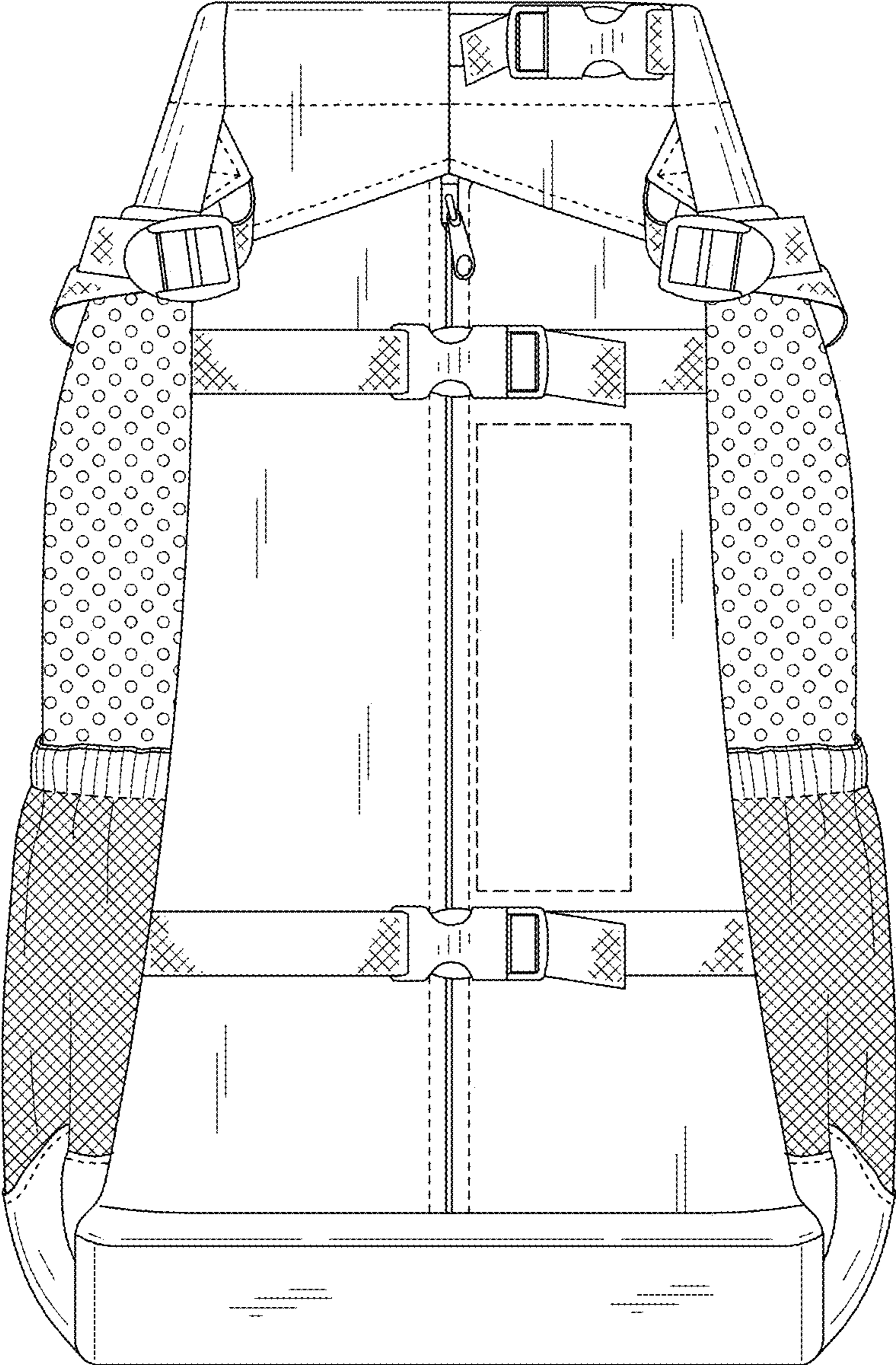

FIG. 2

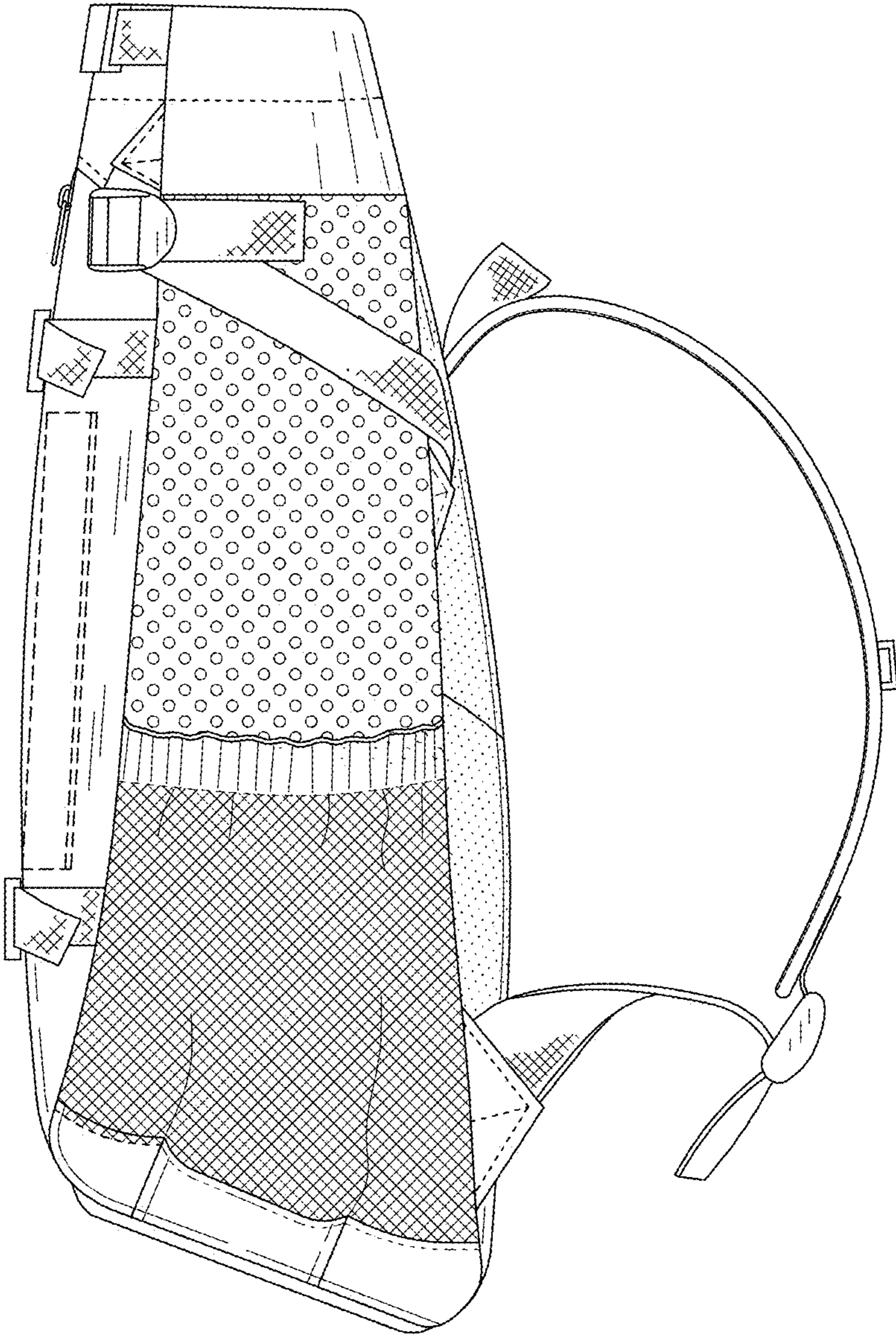

FIG. 3

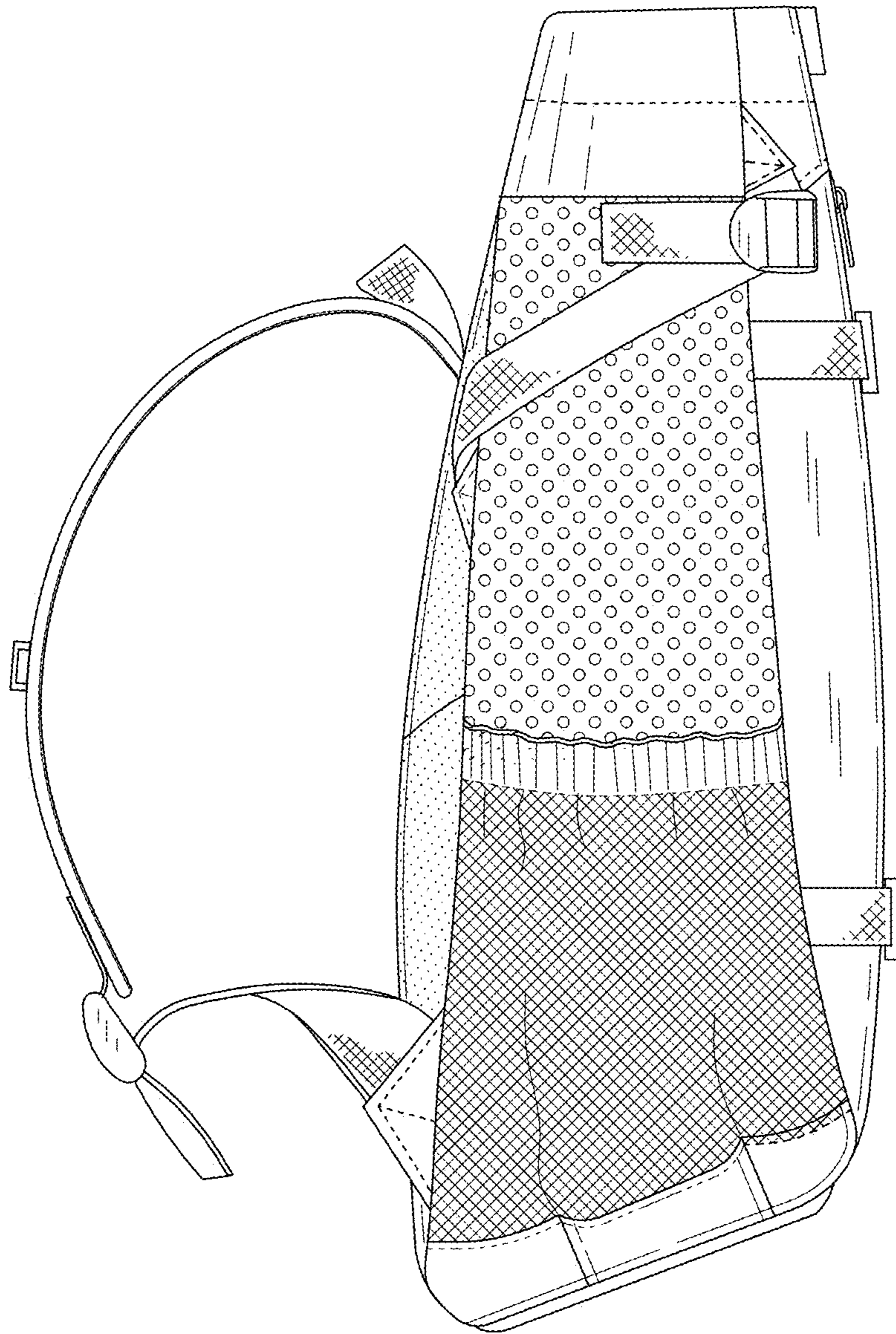

FIG. 4

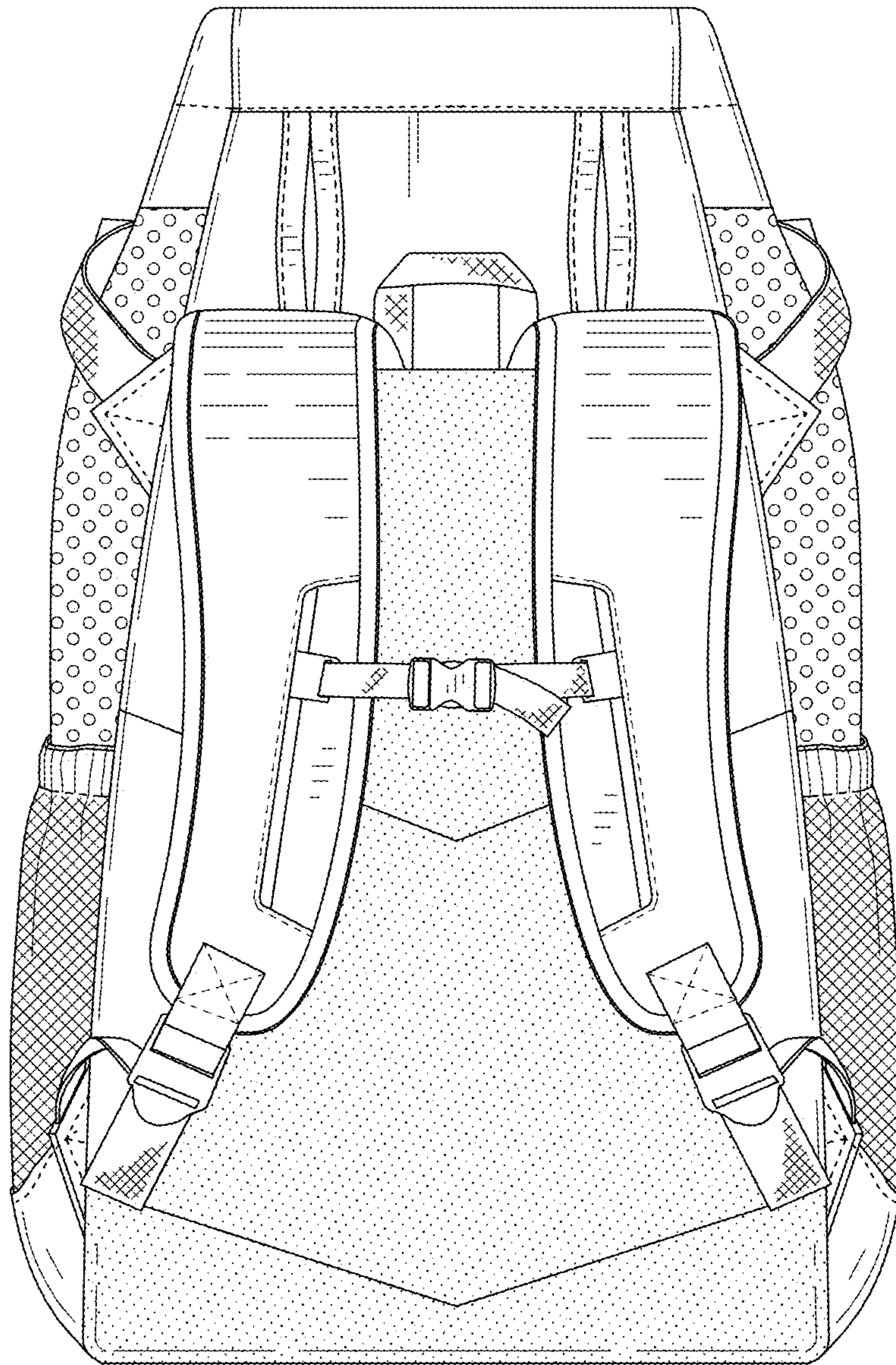

FIG. 5

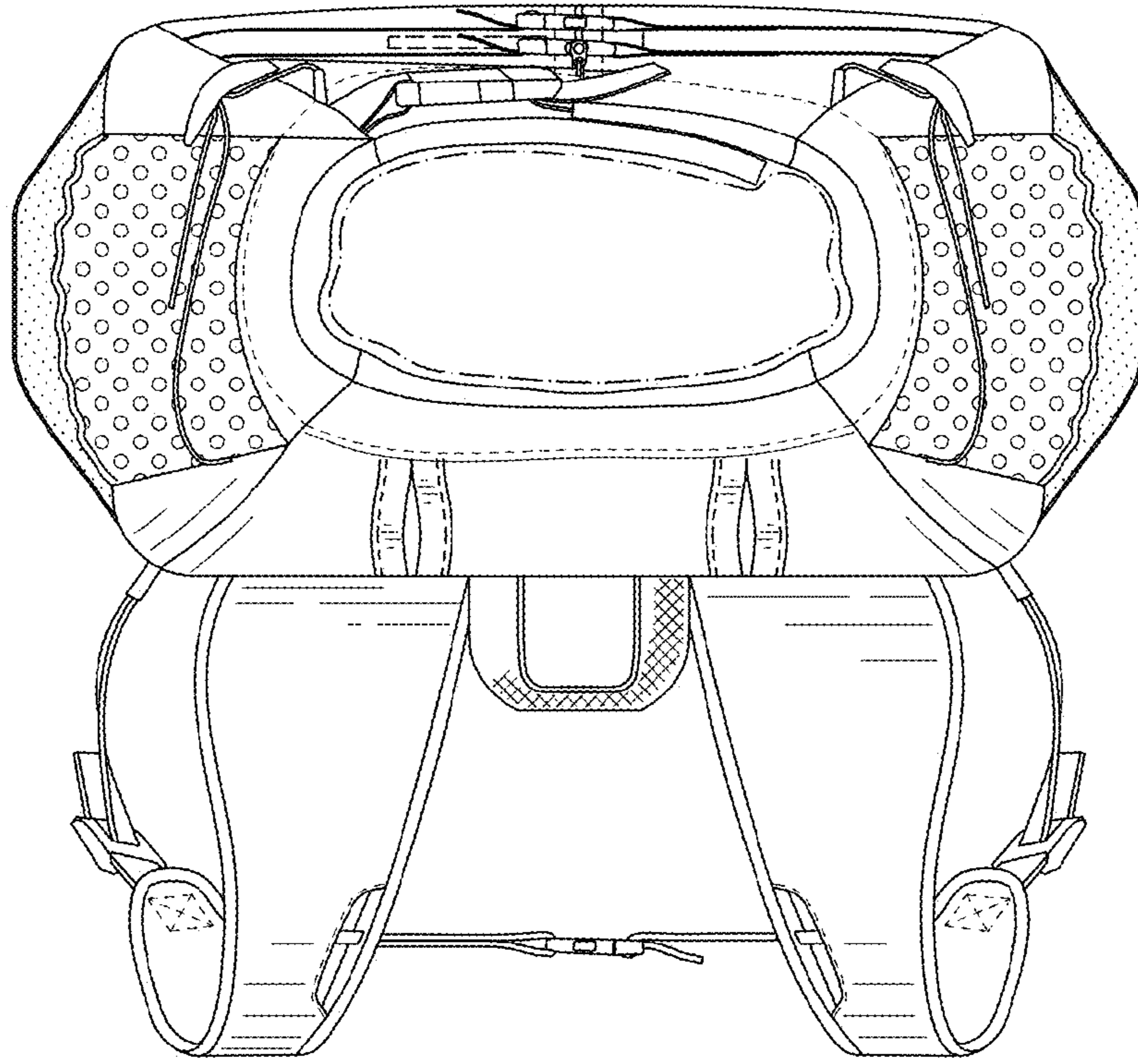

FIG. 6

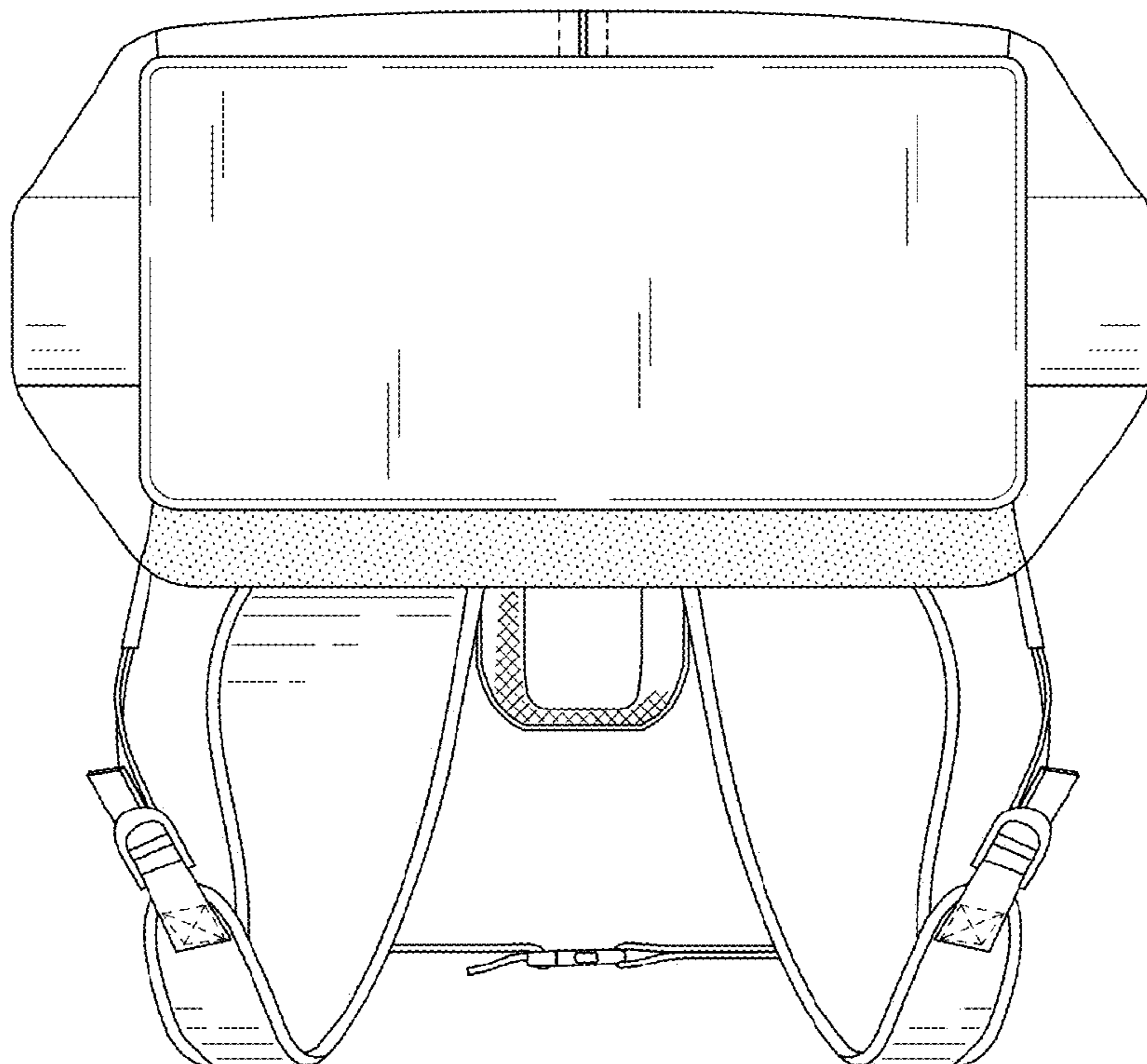

FIG. 7