



US00D982307S

(12) **United States Design Patent**
Wang

(10) **Patent No.:** **US D982,307 S**
(45) **Date of Patent:** **** Apr. 4, 2023**

(54) **PROTECTIVE CASE FOR ELECTRONIC DEVICE**

(71) Applicant: **Shenzhen Lopic Sophisticated Industry Co., Ltd, Shenzhen (CN)**

(72) Inventor: **Jianjun Wang, Shenzhen (CN)**

(73) Assignee: **Shenzhen Lopic Sophisticated Industry Co., Ltd, Shenzhen (CN)**

(**) Term: **15 Years**

(21) Appl. No.: **29/784,719**

(22) Filed: **May 20, 2021**

(30) **Foreign Application Priority Data**

May 12, 2021 (CN) 202130283637.7

(51) **LOC (14) Cl.** **03-02**

(52) **U.S. Cl.**
USPC **D3/207; D10/121**

(58) **Field of Classification Search**
USPC D3/218, 201, 207, 208, 210, 212, 215, D3/269, 294; D10/104.1, 104.2, 121, D10/103, 46, 65, 72, 74; D11/79, 80; D14/432, 439, 440, 250, 496, 217, 251, D14/252, 356, 358; D20/22, 28; D30/155
CPC A45F 2200/05; A45F 2200/0525; B65D 2590/0083; E05B 73/0023; E05B 73/0041; G08B 13/2434; G08B 13/2445
See application file for complete search history.

(56) **References Cited**

U.S. PATENT DOCUMENTS

1,077,025 A * 10/1913 Whitehead A44C 3/00 63/18
D251,274 S * 3/1979 Colan D3/207

D365,371 S * 12/1995 Dunlap D20/28
D647,810 S * 11/2011 Bohrer D10/106.9
D676,618 S * 2/2013 Kal D30/153
D713,404 S * 9/2014 Green D14/344
D783,814 S * 4/2017 Hanuka D24/129
D809,951 S * 2/2018 Yang D10/104.1
D861,602 S * 10/2019 Feng D13/108
D918,072 S * 5/2021 Umair D10/70
D933,046 S * 10/2021 Huang D14/496
D950,236 S * 5/2022 Akana D3/207
D962,632 S * 9/2022 Liu D10/121
D969,655 S * 11/2022 Walker D10/121
2020/0099829 A1 * 3/2020 Lewis G06F 1/1632
2020/0367634 A1 * 11/2020 Lewis H04M 1/04

* cited by examiner

Primary Examiner — Marie D. Fast Horse
Assistant Examiner — Josiah D Parsons

(57) **CLAIM**

The ornamental design for a protective case for electronic device, as shown and described.

DESCRIPTION

FIG. 1 is a perspective view of a protective case for electronic device showing my new design; FIG. 2 is another perspective view thereof; FIG. 3 is a front elevational view thereof; FIG. 4 is a rear elevational view thereof; FIG. 5 is a left side elevational view thereof; FIG. 6 is a right side elevational view thereof; FIG. 7 is a top plan view thereof; and, FIG. 8 is a bottom plan view thereof. The broken lines in the drawings are for the purpose of illustrating portions of the protective case for electronic device that form no part of the claimed design.

1 Claim, 8 Drawing Sheets

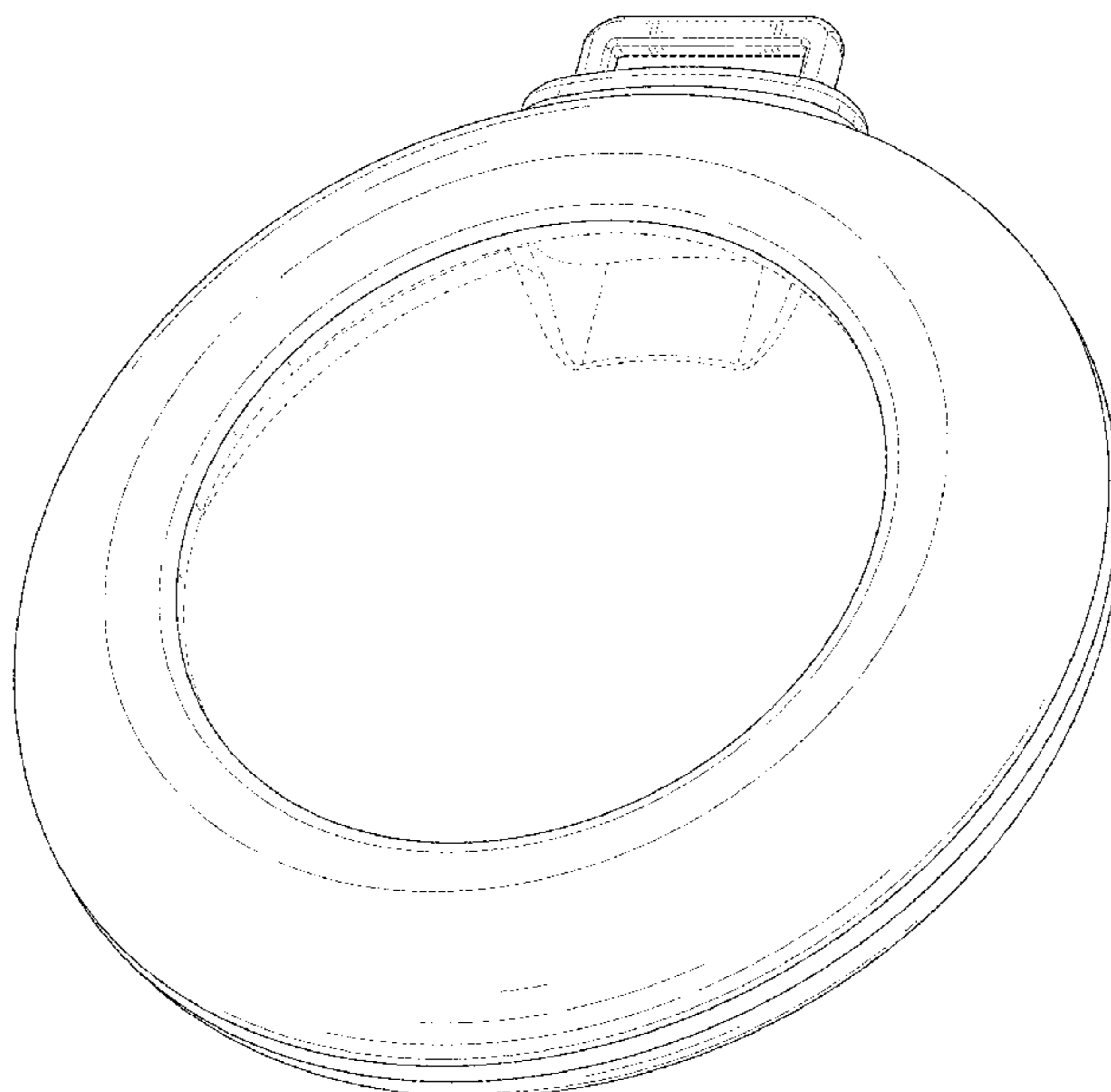

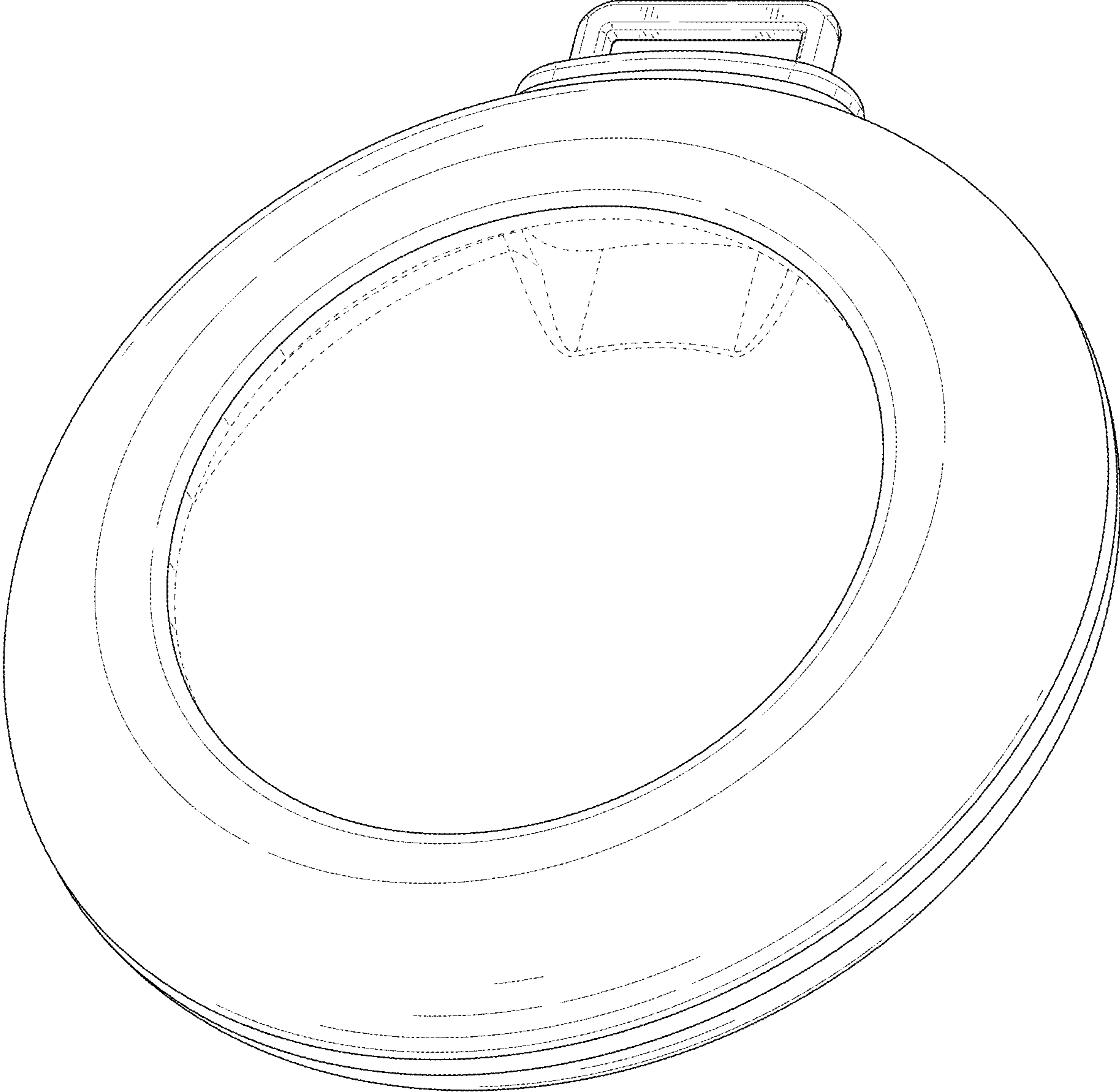

FIG. 1

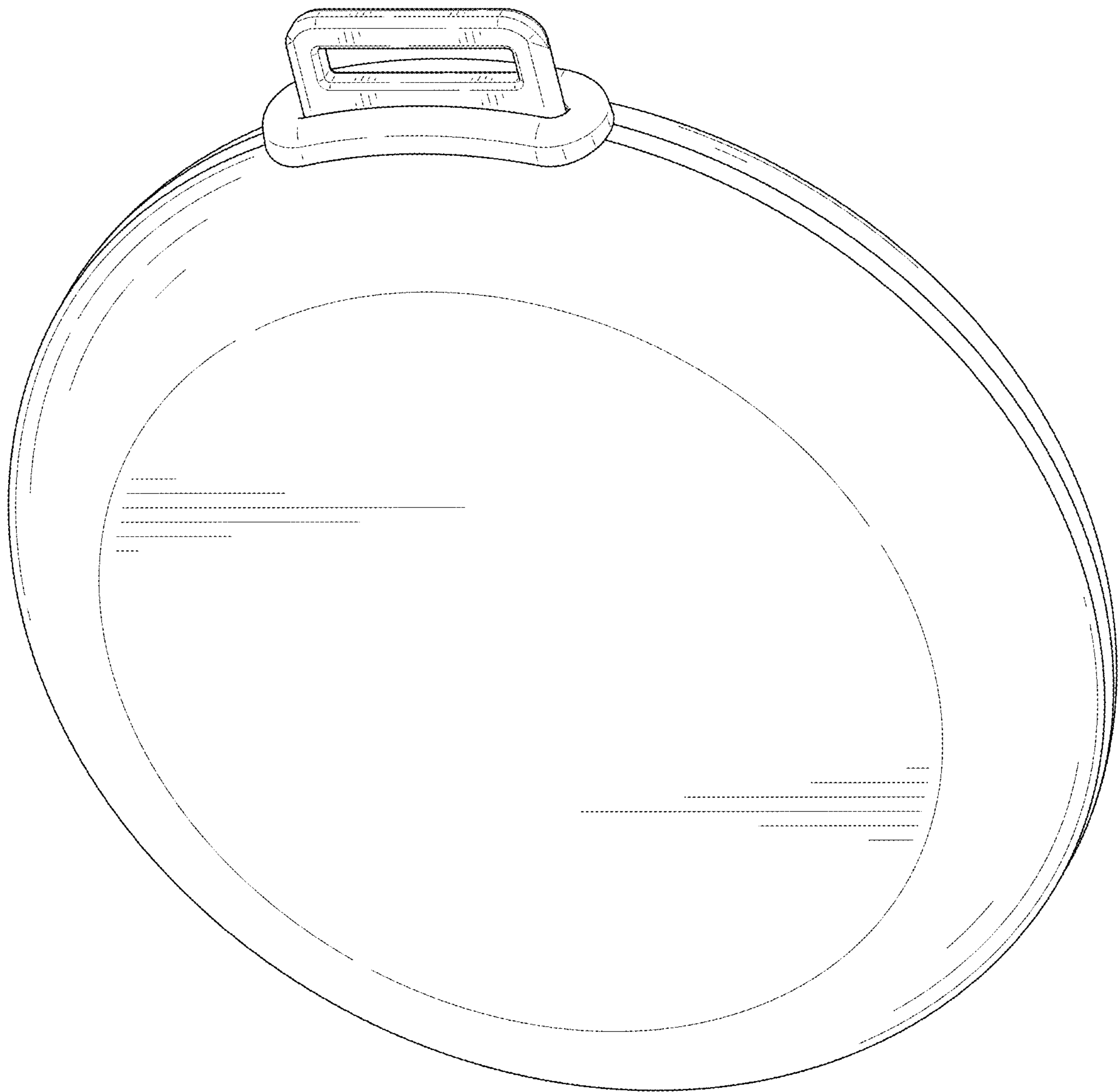

FIG. 2

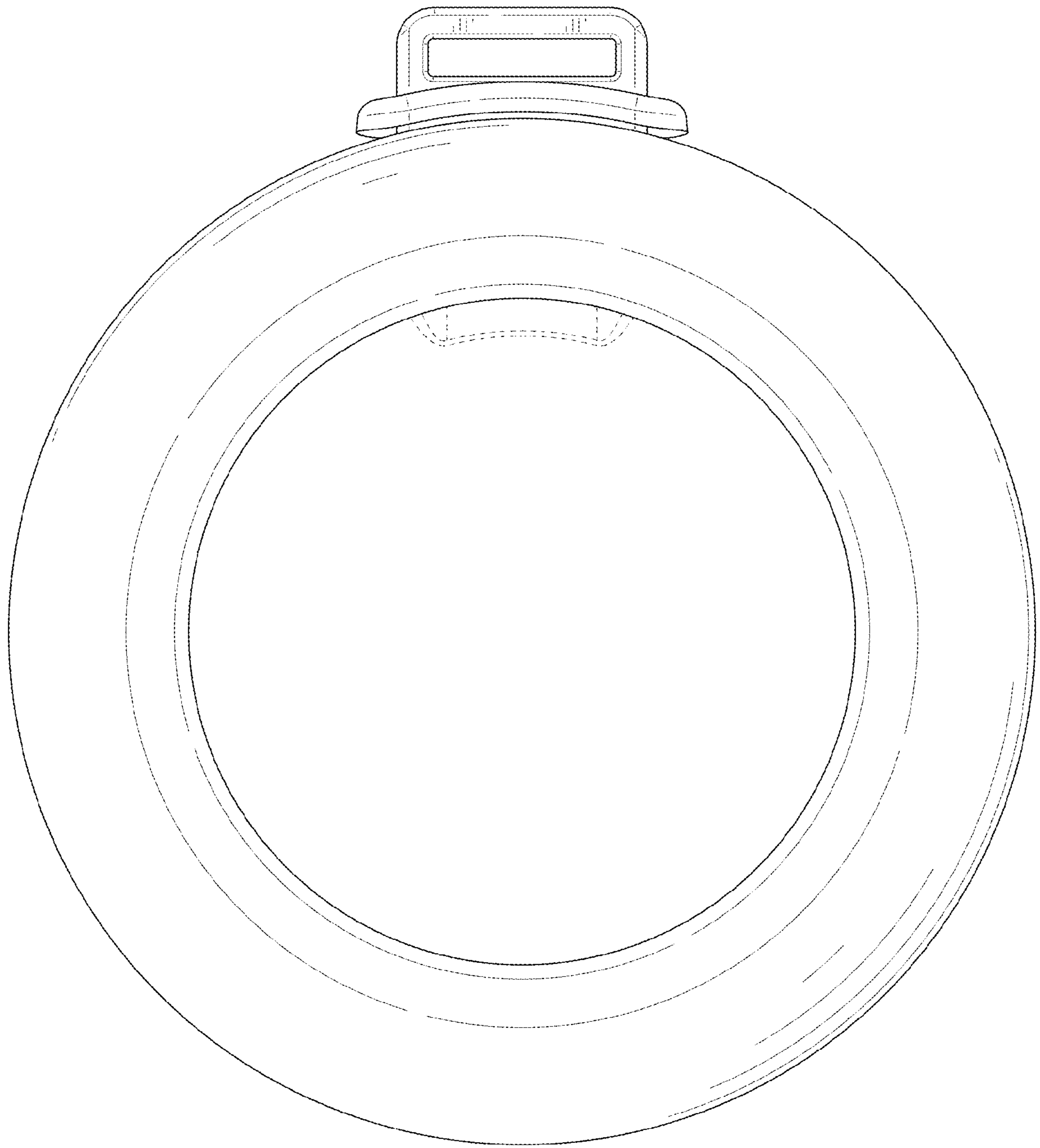

FIG. 3

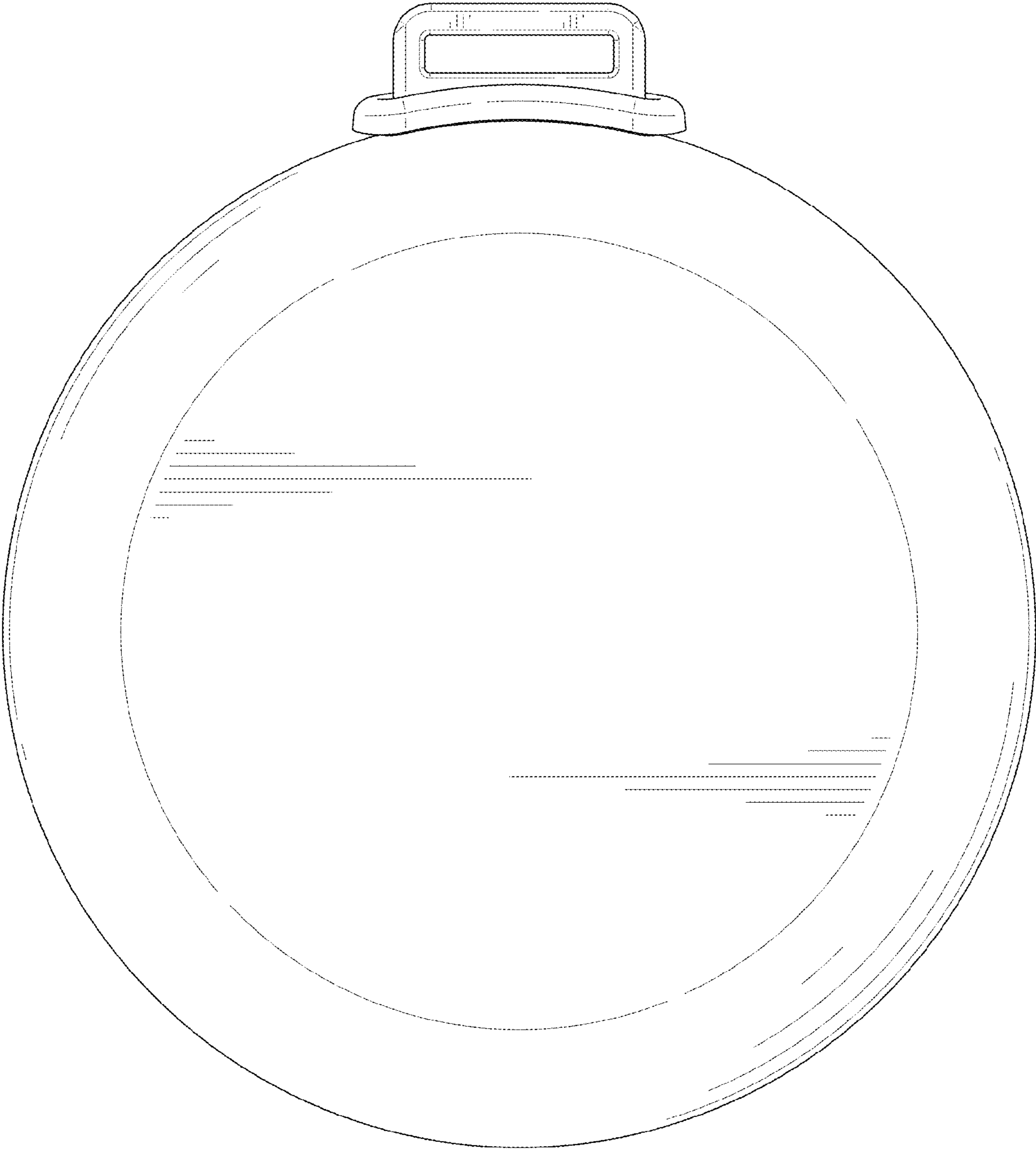

FIG. 4

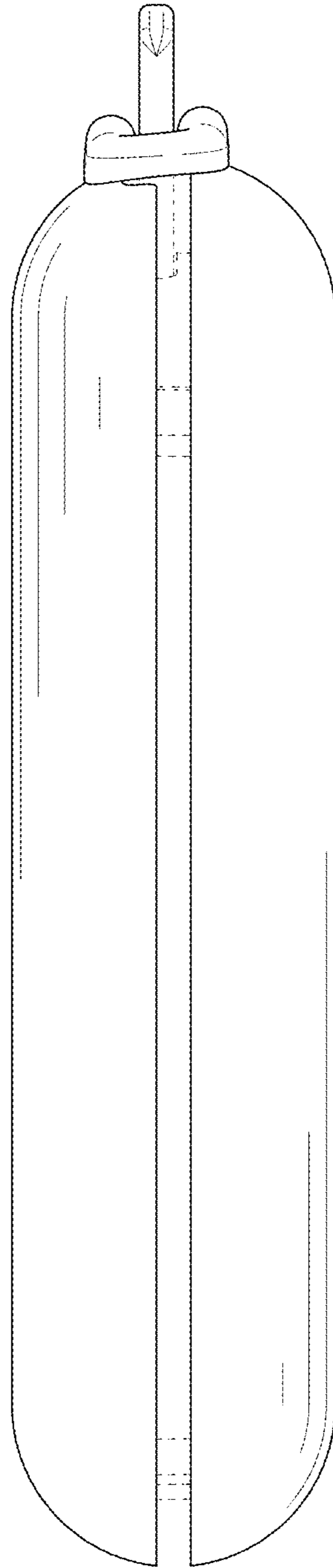

FIG. 5

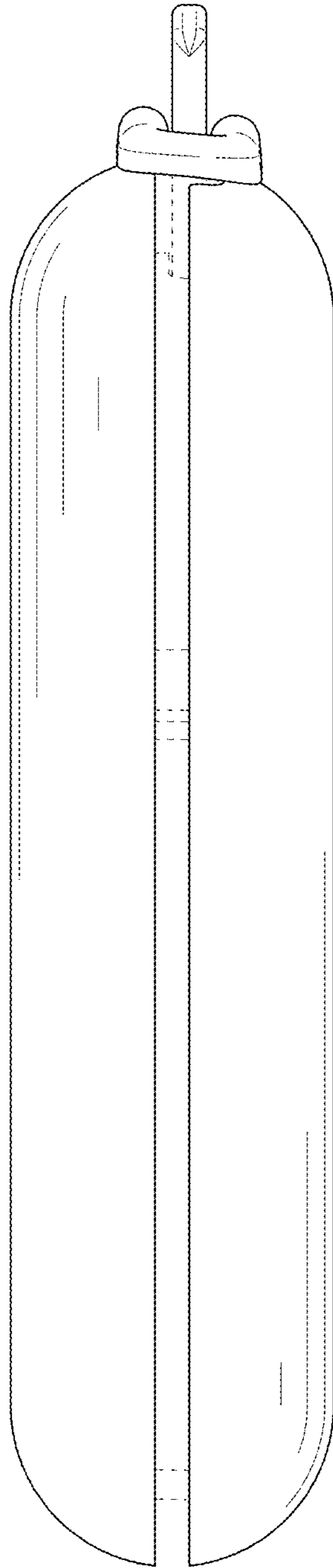

FIG. 6

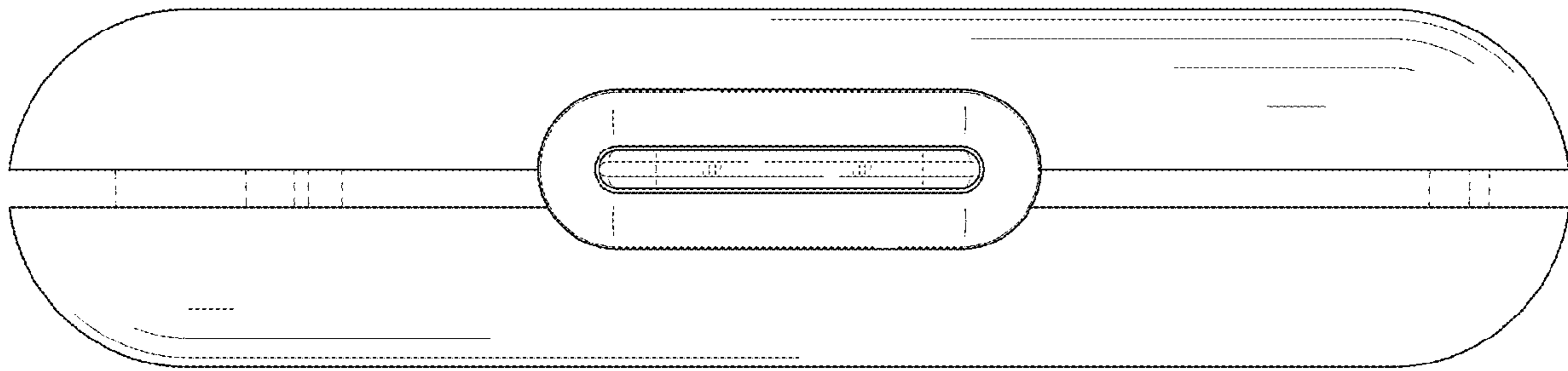

FIG. 7

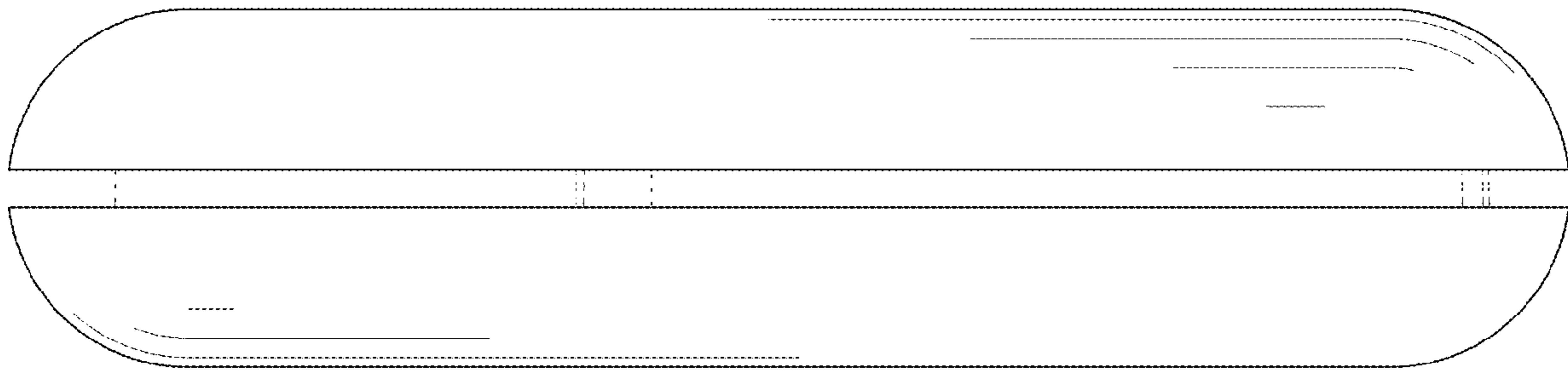

FIG. 8