



US00D982234S

(12) **United States Design Patent**
Chen

(10) **Patent No.:** **US D982,234 S**

(45) **Date of Patent:** **** Mar. 28, 2023**

(54) **HAIR CLIP**

(71) Applicant: **Yating Chen**, Yuzhou (CN)

(72) Inventor: **Yating Chen**, Yuzhou (CN)

(**) Term: **15 Years**

(21) Appl. No.: **29/863,919**

(22) Filed: **Dec. 23, 2022**

(51) **LOC (14) Cl.** **28-03**

(52) **U.S. Cl.**
USPC **D28/40**

(58) **Field of Classification Search**

USPC D28/39, 40, 42, 43

CPC . A45D 8/00; A45D 8/002; A45D 8/14; A45D
8/16; A45D 8/18; A45D 8/20; A45D

8/22; A45D 8/24; A45D 8/30

See application file for complete search history.

(56) **References Cited**

U.S. PATENT DOCUMENTS

D158,343 S * 4/1950 Watson D28/11

D415,591 S * 10/1999 Knudsen D28/40

D473,015 S * 4/2003 Shyu D28/40

D473,016 S * 4/2003 Shyu D28/40

D583,991 S 12/2008 Pichon

D641,103 S * 7/2011 Tsai D28/40

D923,245 S 6/2021 Liu

D968,701 S * 11/2022 Denham D28/40

* cited by examiner

Primary Examiner — Zenia I Bennett

(74) *Attorney, Agent, or Firm* — Georgi Korobanov

(57) **CLAIM**

The ornamental design for a hair clip, as shown and described.

DESCRIPTION

FIG. 1 is a front, right and bottom perspective view of a hair clip, showing my new design;

FIG. 2 is a rear, left and top perspective view thereof;

FIG. 3 is a front view thereof;

FIG. 4 is a rear view thereof;

FIG. 5 is a left side view thereof;

FIG. 6 is a right side view thereof;

FIG. 7 is a top plan view thereof; and,

FIG. 8 is a bottom plan view thereof.

1 Claim, 8 Drawing Sheets

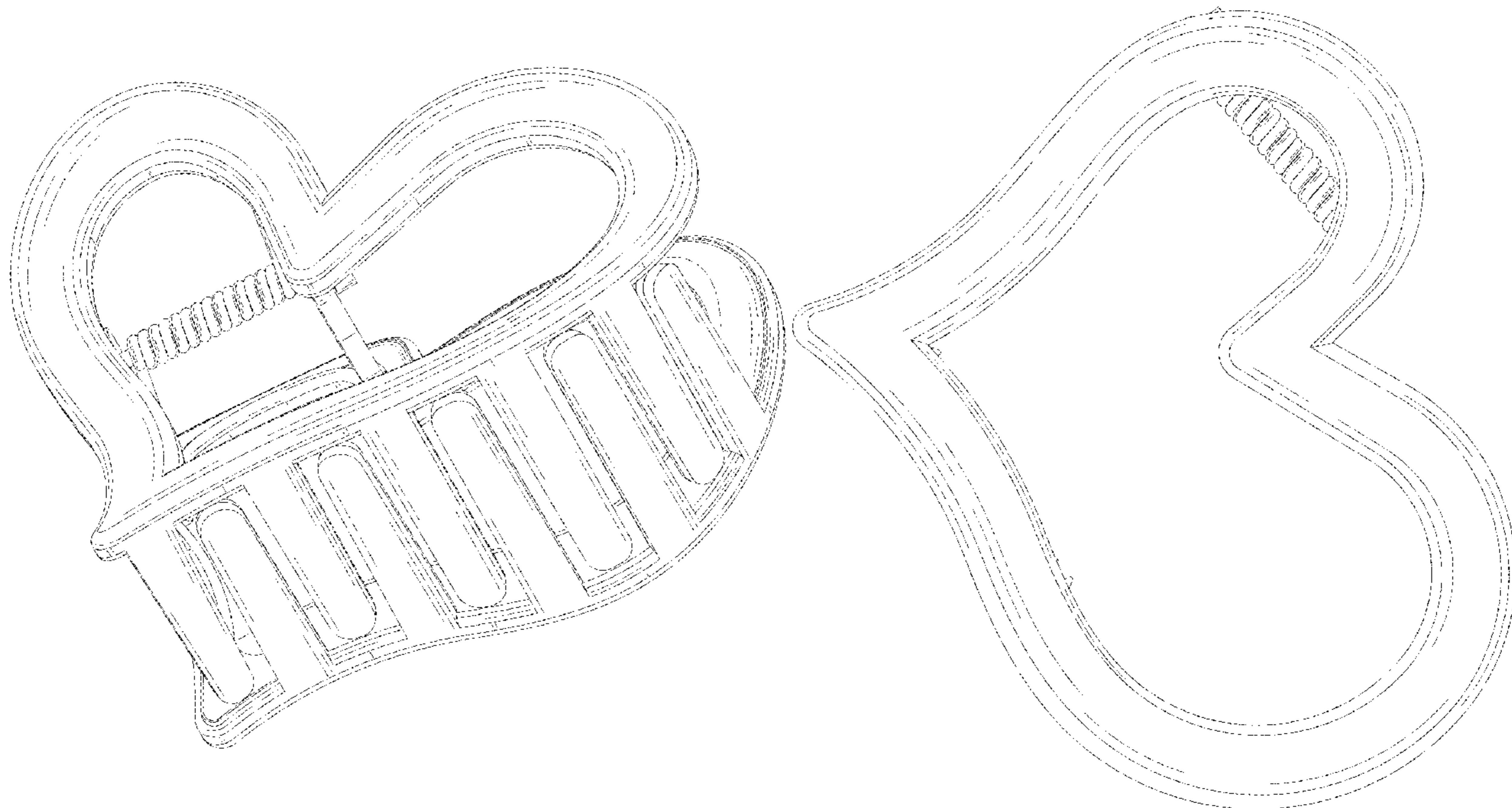

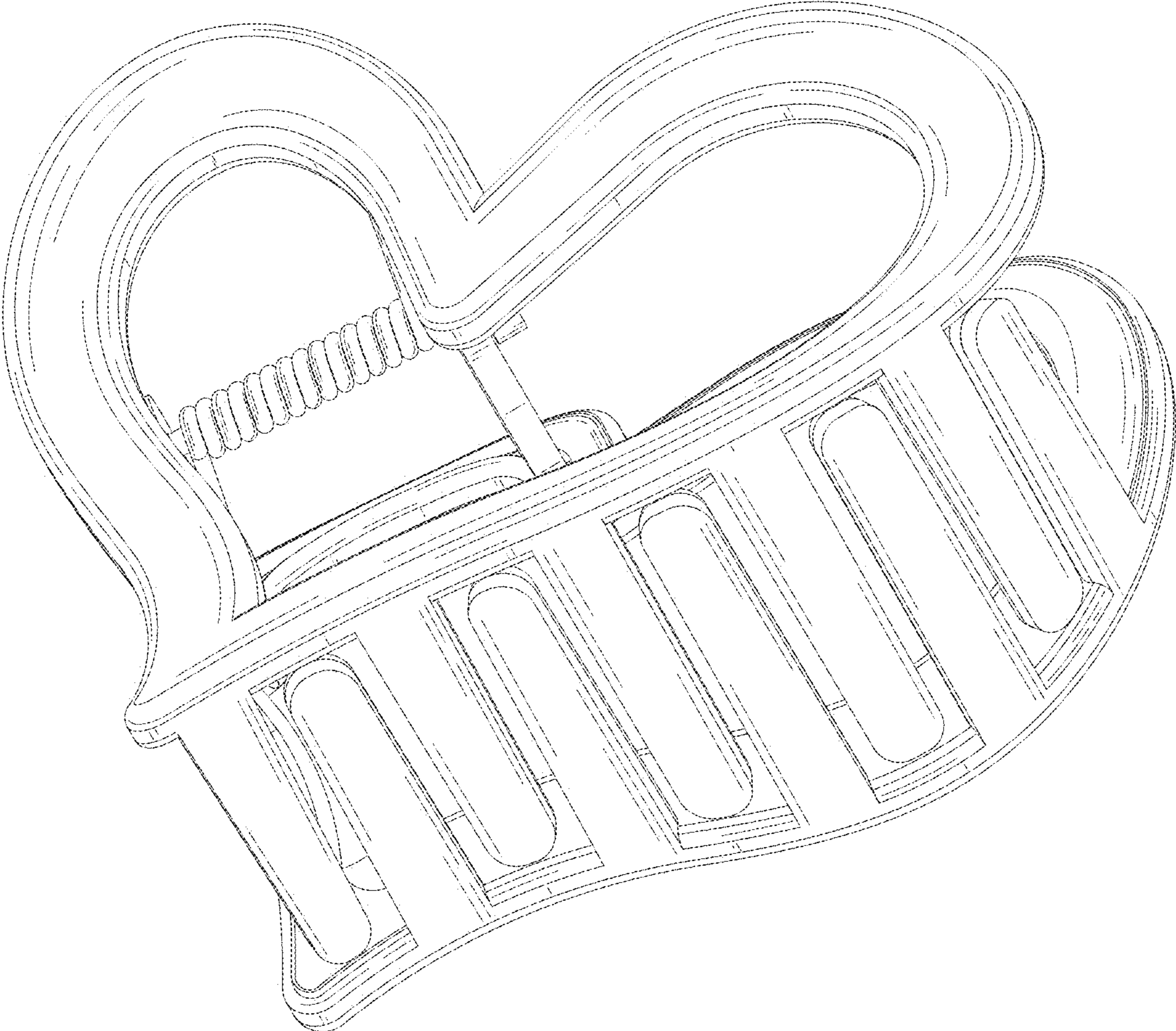

FIG. 1

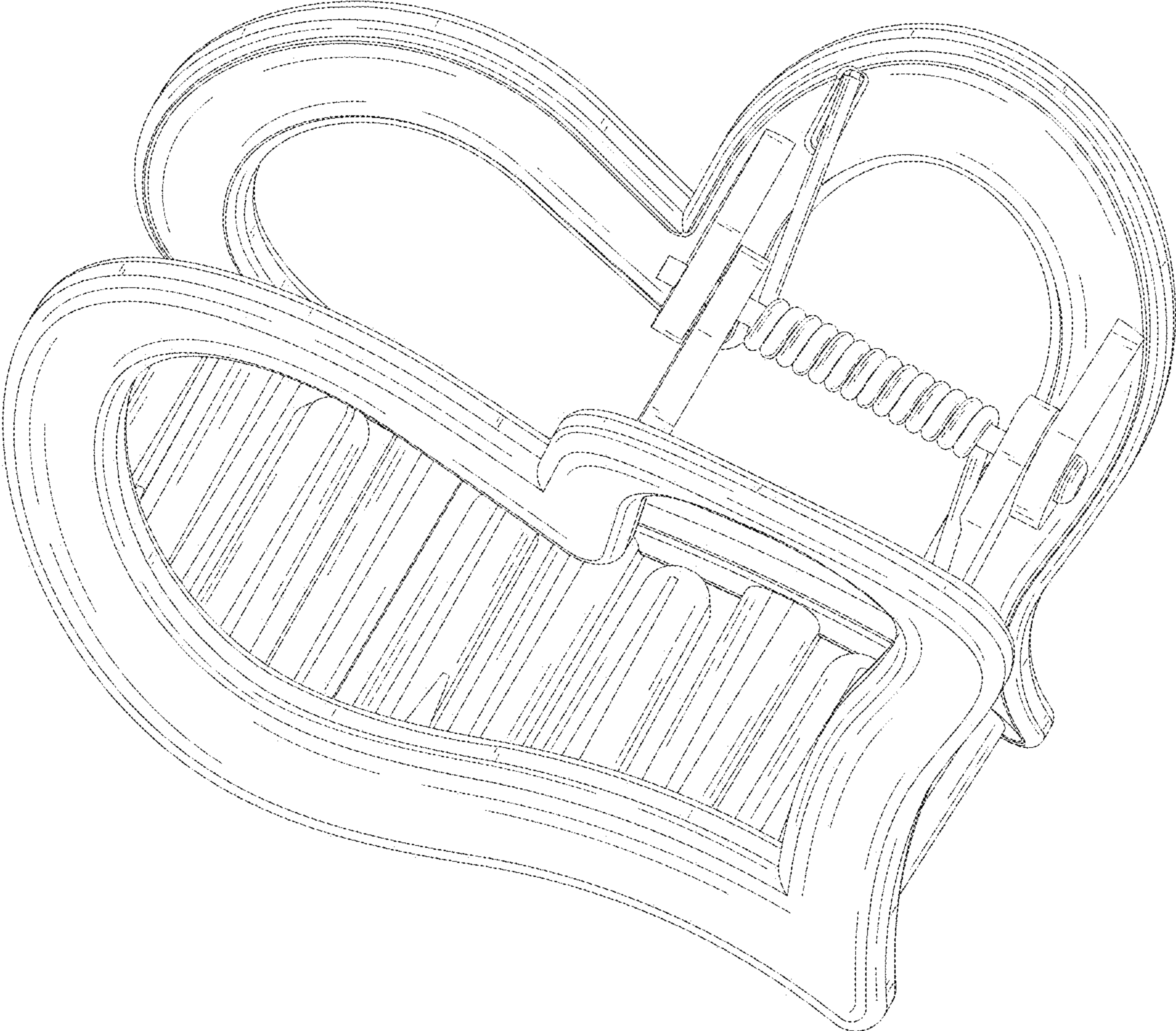

FIG. 2

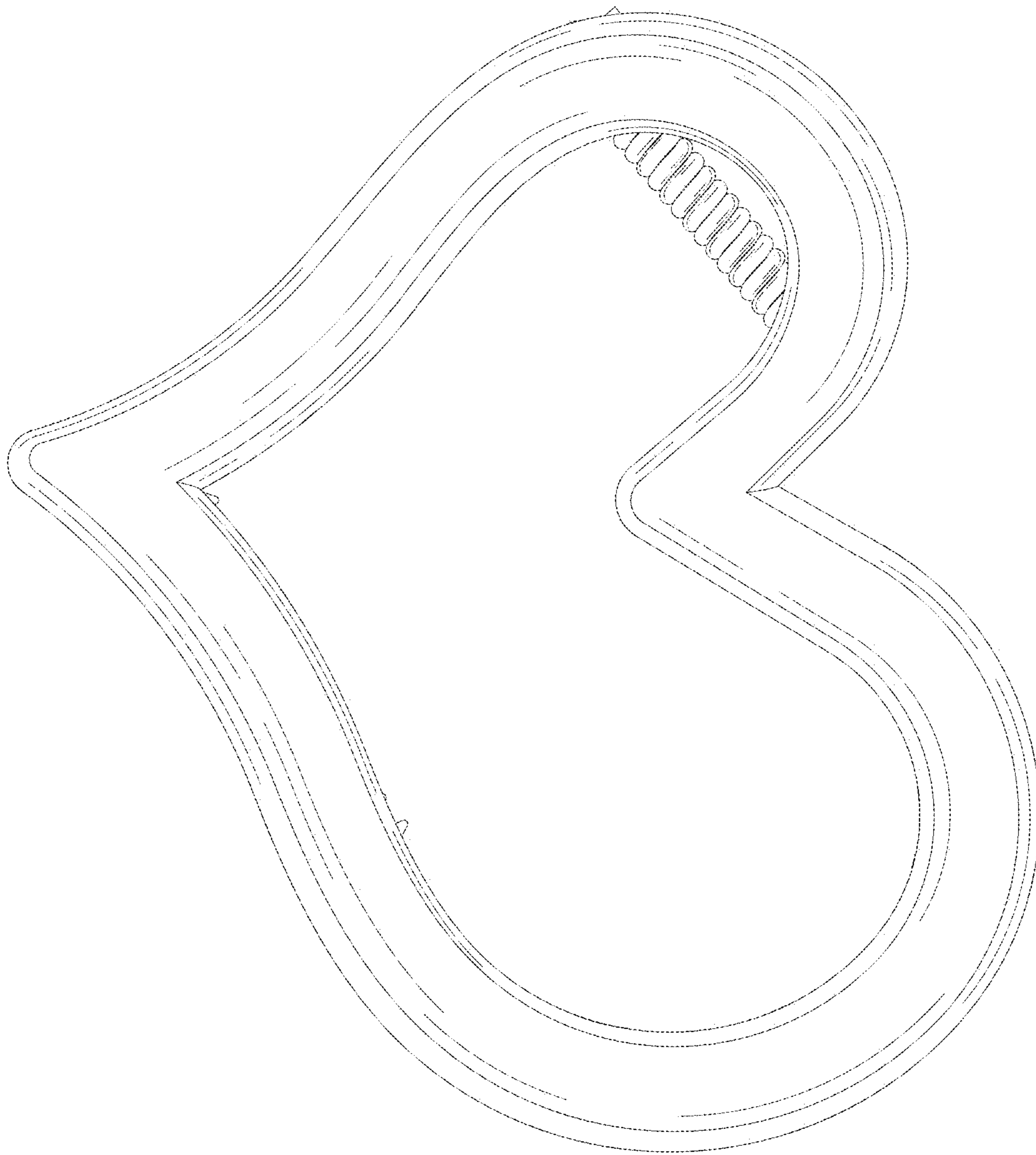

FIG. 3

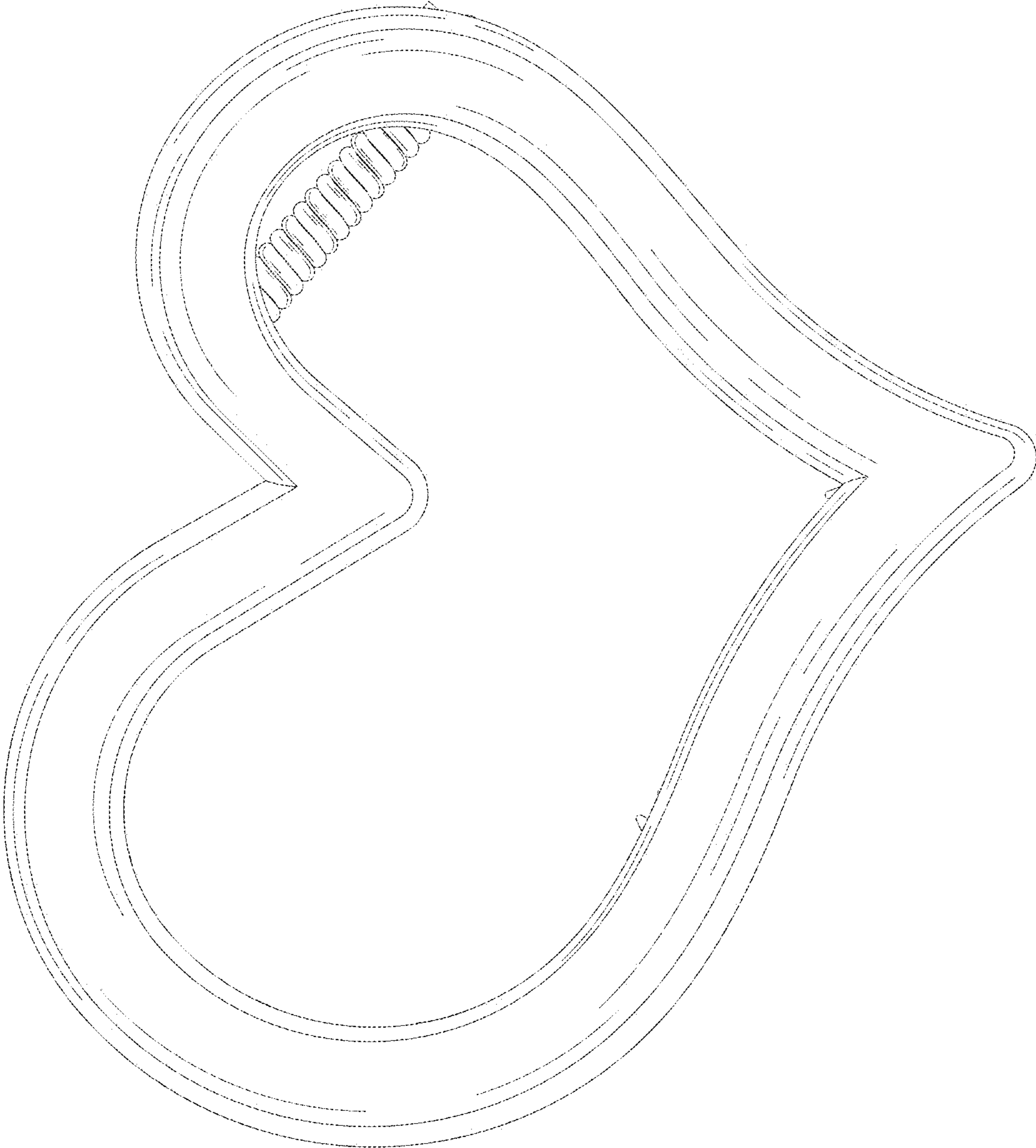

FIG. 4

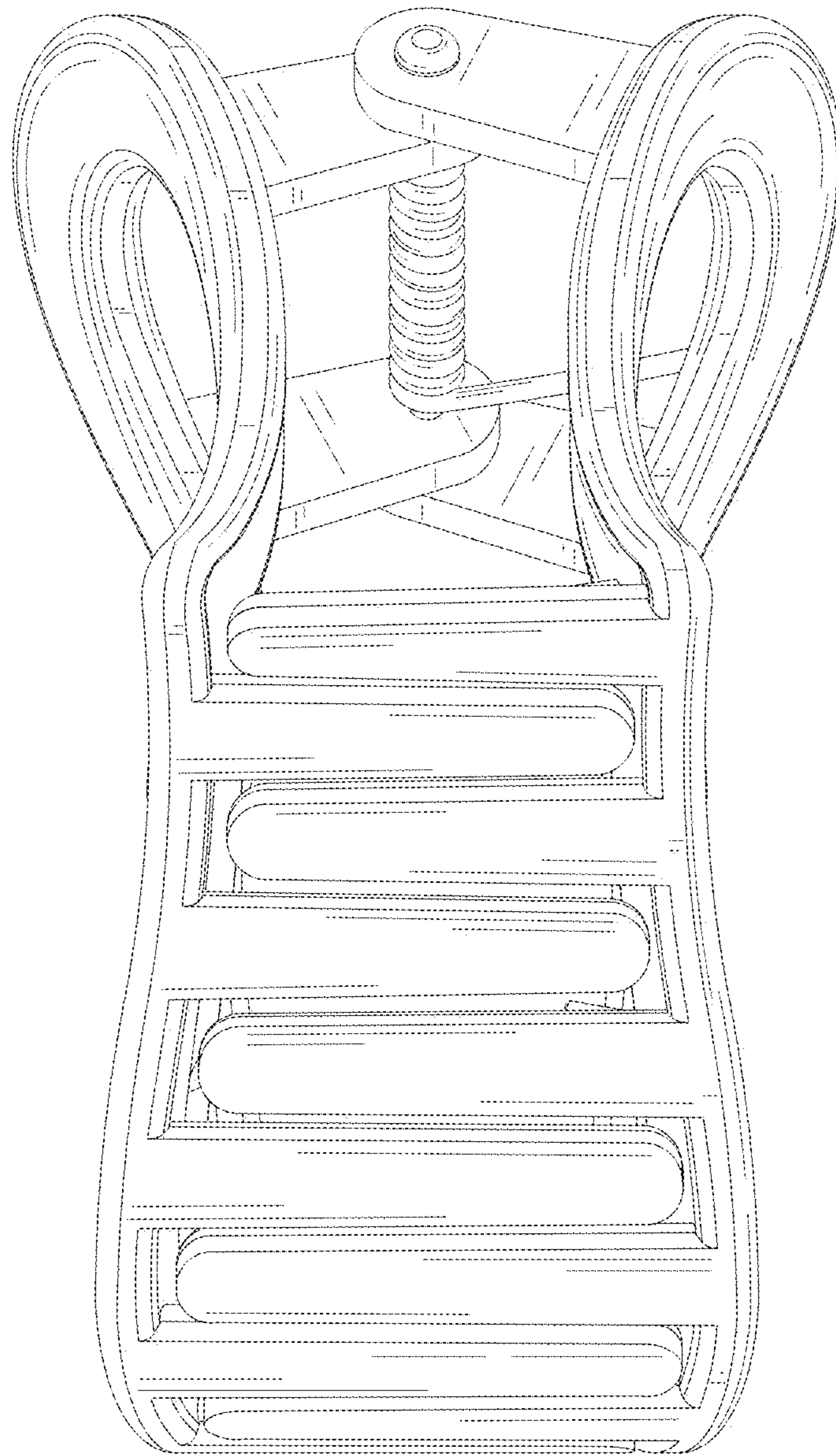

FIG. 5

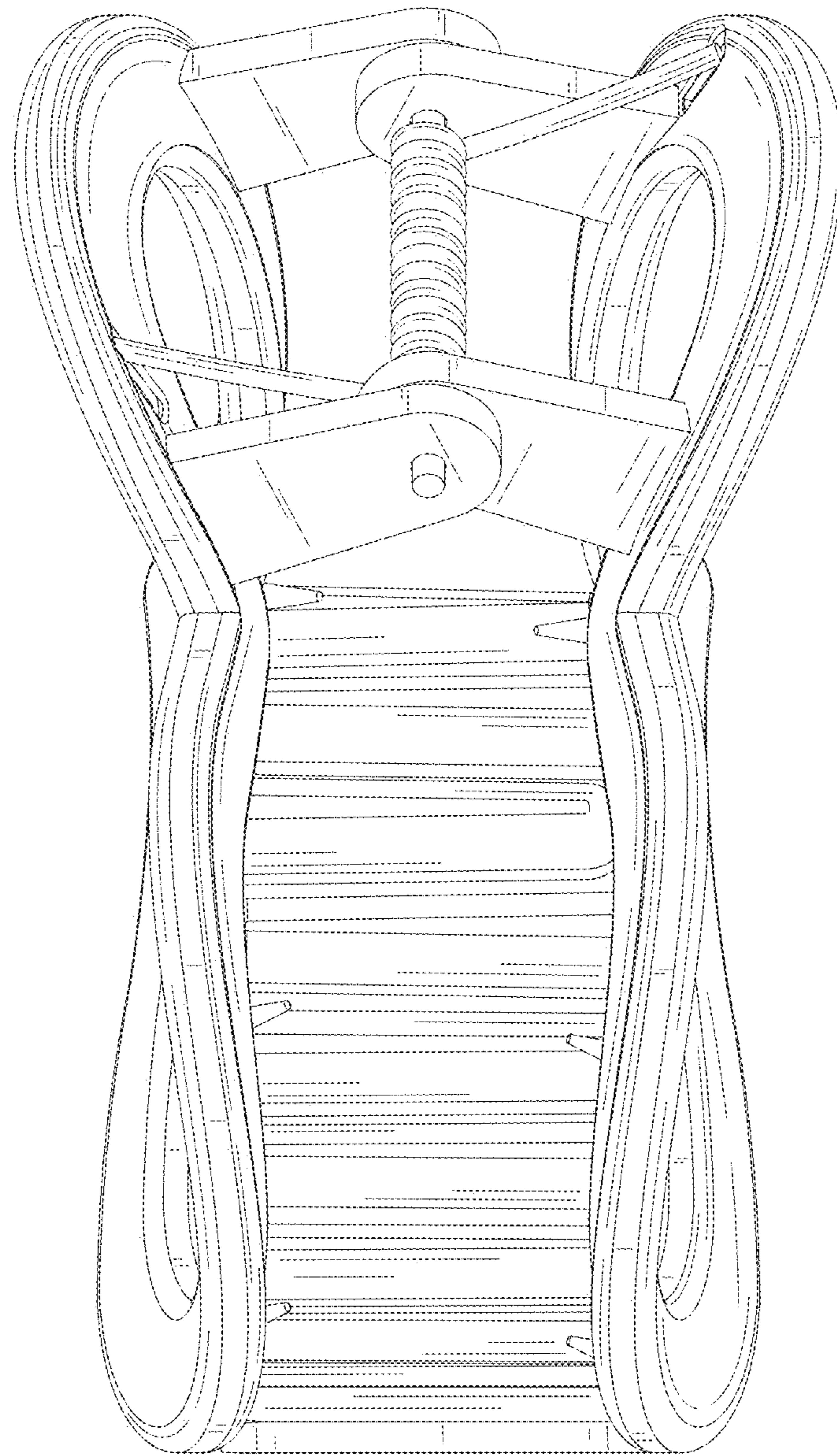

FIG. 6

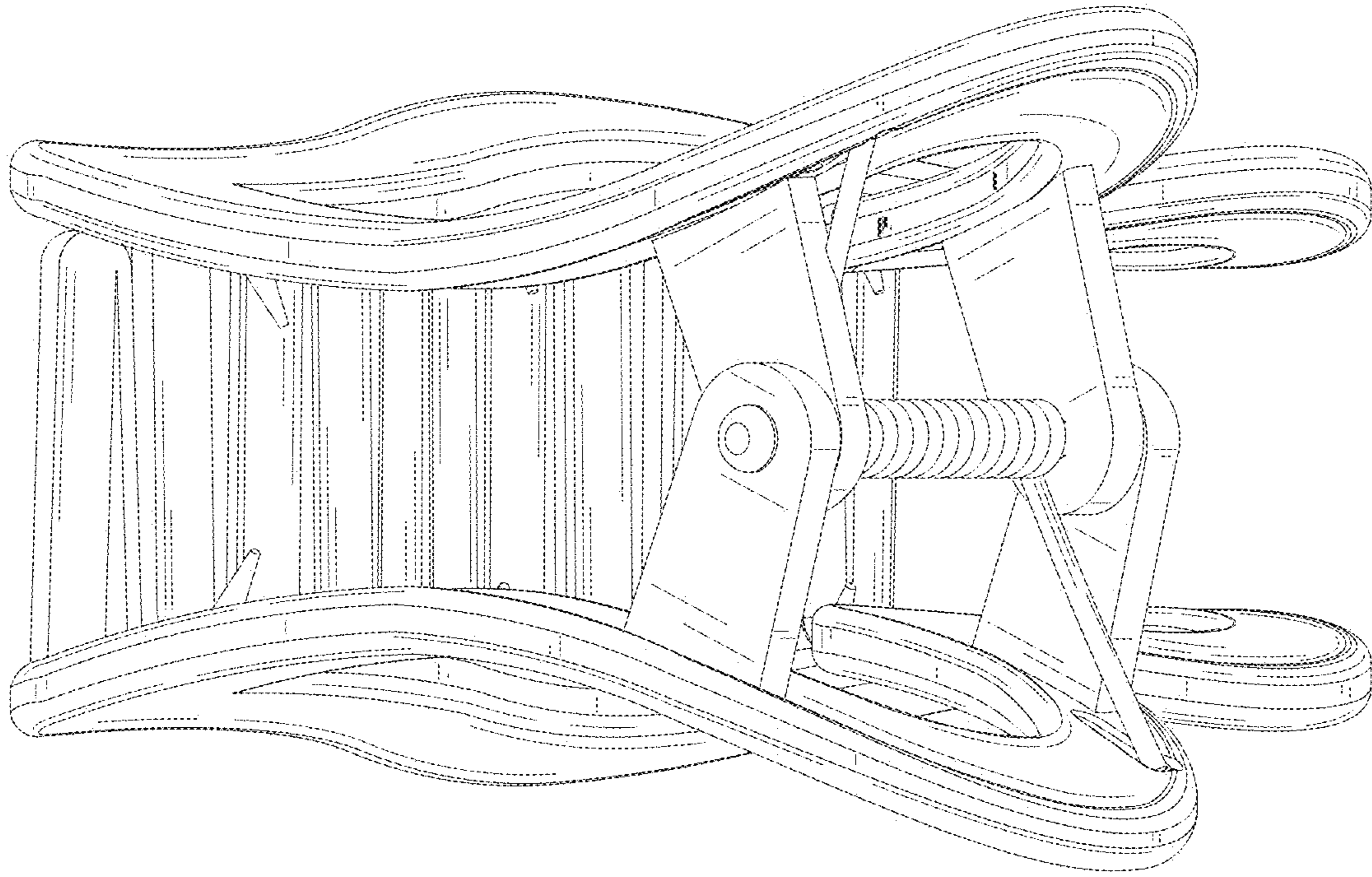

FIG. 7

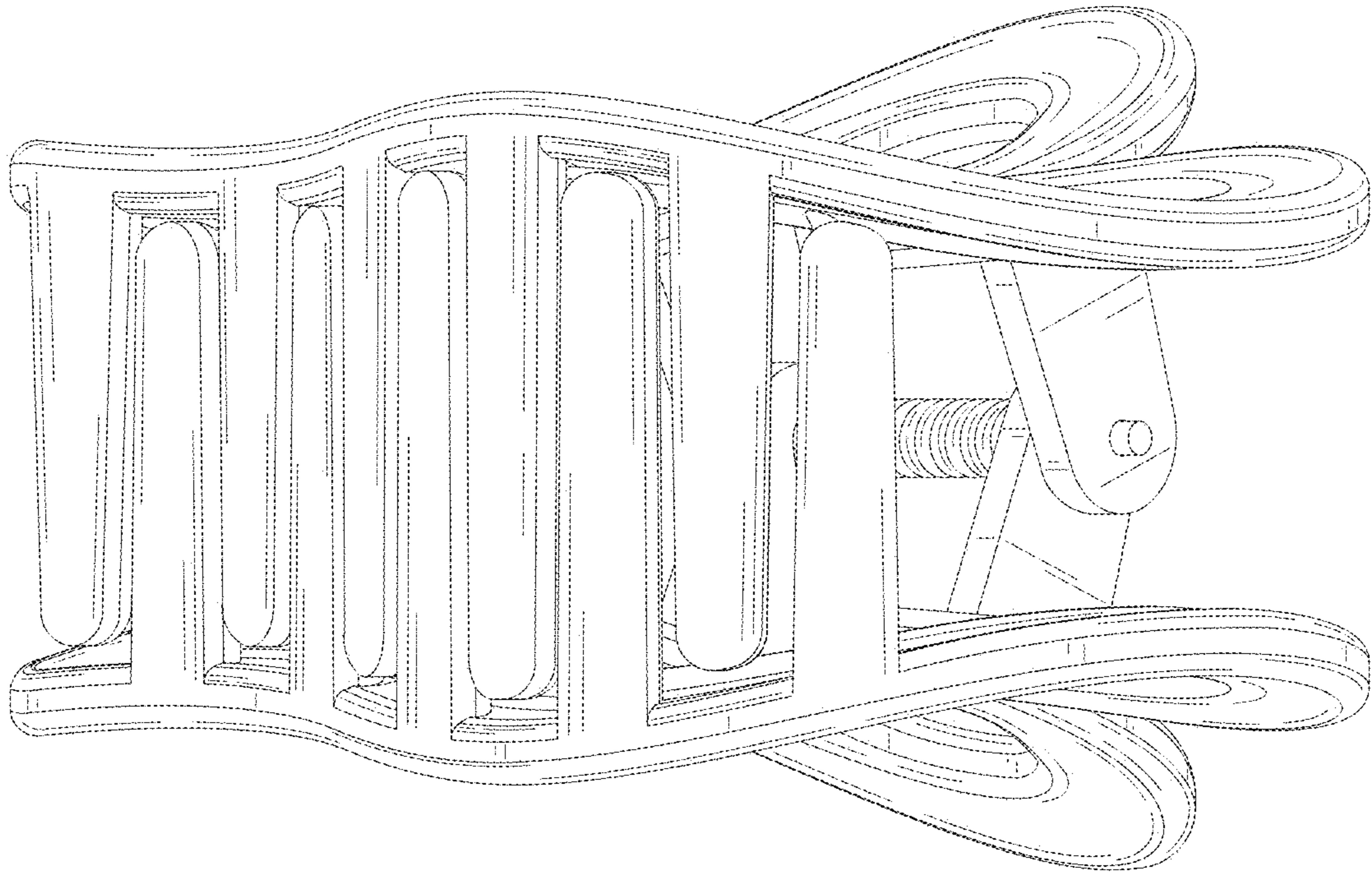

FIG. 8