



US00D982227S

(12) **United States Design Patent** (10) **Patent No.:** **US D982,227 S**
Plevnik et al. (45) **Date of Patent:** **** Mar. 28, 2023**

(54) **ELECTRONIC CIGARETTE**

Primary Examiner — Khawaja Anwar

(71) Applicant: **JT International S.A.**, Geneva (CH)

(57) **CLAIM**

(72) Inventors: **Marko Plevnik**, London (GB);
Norihiko Inoue, London (GB)

The ornamental design for an electronic cigarette, as shown and described.

(**) Term: **15 Years**

DESCRIPTION

(21) Appl. No.: **35/511,243**

The patent or application file contains at least one drawing executed in color. Copies of this patent or patent application publication with color drawing(s) will be provided by the Office upon request and payment of the necessary fee.

(22) Filed: **Jul. 23, 2020**

(80) **Hague Agreement Data**

Int. Filing Date: **Jul. 23, 2020**
Int. Reg. No.: **DM/211246**
Int. Reg. Date: **Jul. 23, 2020**
Int. Reg. Pub. Date: **Jan. 29, 2021**

FIG. 3.1 is a perspective view of an electronic cigarette, according to a first embodiment of our new design;

FIG. 3.2 is a right side view thereof;

FIG. 3.3 is a left side view thereof;

FIG. 3.4 is a front elevation view thereof;

FIG. 3.5 is a rear view thereof;

FIG. 3.6 is a top plan view thereof;

FIG. 3.7 is a bottom plan view thereof;

(30) **Foreign Application Priority Data**

Jan. 23, 2020 (EM) 7547427

FIG. 4.1 is a perspective view of an electronic cigarette, according to a second embodiment of our new design;

FIG. 4.2 is a right side view thereof;

FIG. 4.3 is a left side view thereof;

FIG. 4.4 is a front elevation view thereof;

FIG. 4.5 is a rear view thereof;

FIG. 4.6 is a top plan view thereof;

FIG. 4.7 is a bottom plan view thereof;

(51) **LOC (14) Cl.** **27-03**

(52) **U.S. Cl.**
USPC **D27/162**

(58) **Field of Classification Search**
USPC D27/162, 100, 101, 163, 164, 165, 167,
D27/169, 172, 174, 183, 185–192, 194;
D24/110, 110.5; D9/516, 522, 523
See application file for complete search history.

FIG. 7.1 is a perspective view of an electronic cigarette, according to a third embodiment of our new design;

FIG. 7.2 is a right side view thereof;

FIG. 7.3 is a left side view thereof;

FIG. 7.4 is a front elevation view thereof;

FIG. 7.5 is a rear view thereof;

FIG. 7.6 is a top plan view thereof;

FIG. 7.7 is a bottom plan view thereof;

(56) **References Cited**

U.S. PATENT DOCUMENTS

D846,796 S * 4/2019 Pan D27/101
D881,454 S * 4/2020 Wright D27/162
(Continued)

FIG. 8.1 is a perspective view of an electronic cigarette, according to a fourth embodiment of our new design;

FIG. 8.2 is a right side view thereof;

FIG. 8.3 is a left side view thereof;

FIG. 8.4 is a front elevation view thereof;

FIG. 8.5 is a rear view thereof;

FIG. 8.6 is a top plan view thereof;

OTHER PUBLICATIONS

Plevnik et al., U.S. Appl. No. 35/509,824, filed Jul. 17, 2020, entitled "Electronic Cigarette".

(Continued)

(Continued)

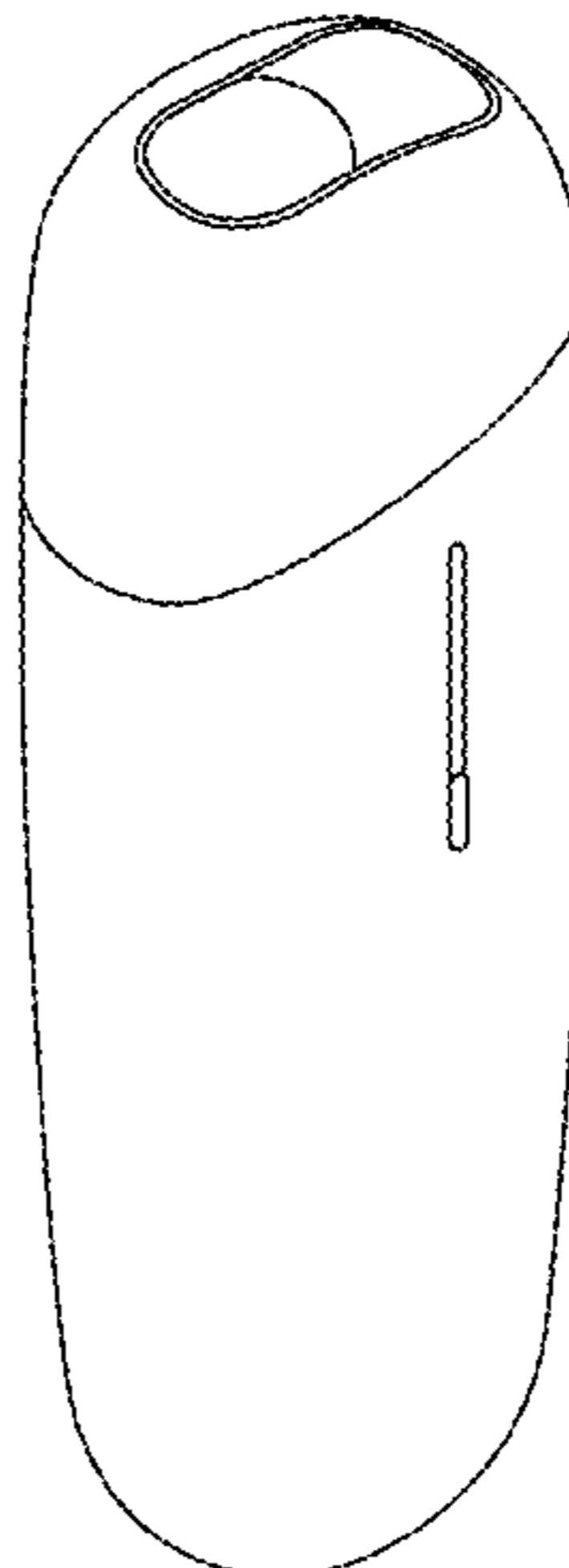

FIG. 8.7 is a bottom plan view thereof;
 FIG. 11.1 is a perspective view of an electronic cigarette, according to a fifth embodiment of our new design;
 FIG. 11.2 is a right side view thereof;
 FIG. 11.3 is a left side view thereof;
 FIG. 11.4 is a front elevation view thereof;
 FIG. 11.5 is a rear view thereof;
 FIG. 11.6 is a top plan view thereof;
 FIG. 11.7 is a bottom plan view thereof;
 FIG. 12.1 is a perspective view of an electronic cigarette, according to a sixth embodiment of our new design;
 FIG. 12.2 is a right side view thereof;
 FIG. 12.3 is a left side view thereof;
 FIG. 12.4 is a front elevation view thereof;
 FIG. 12.5 is a rear view thereof;
 FIG. 12.6 is a top plan view thereof;
 FIG. 12.7 is a bottom plan view thereof;
 FIG. 18.1 is a perspective view of an electronic cigarette, according to a seventh embodiment of our new design;
 FIG. 18.2 is a right side view thereof;
 FIG. 18.3 is a left side view thereof;
 FIG. 18.4 is a front elevation view thereof;
 FIG. 18.5 is a rear view thereof;
 FIG. 18.6 is a top plan view thereof;
 FIG. 18.7 is a bottom plan view thereof;
 FIG. 19.1 is a perspective view of an electronic cigarette, according to an eighth embodiment of our new design;
 FIG. 19.2 is a right side view thereof;
 FIG. 19.3 is a left side view thereof;
 FIG. 19.4 is a front elevation view thereof;
 FIG. 19.5 is a rear view thereof;
 FIG. 19.6 is a top plan view thereof;
 FIG. 19.7 is a bottom plan view thereof;
 FIG. 22.1 is a perspective view of an electronic cigarettes, according to a ninth embodiment of our new design;
 FIG. 22.2 is a right side view thereof;
 FIG. 22.3 is a left side view thereof;
 FIG. 22.4 is a front elevation view thereof;
 FIG. 22.5 is a rear view thereof;
 FIG. 22.6 is a top plan view thereof;
 FIG. 22.7 is a bottom plan view thereof;
 FIG. 23.1 is a perspective view of an electronic cigarette, according to a tenth embodiment of our new design;
 FIG. 23.2 is a right side view thereof;
 FIG. 23.3 is a left side view thereof;
 FIG. 23.4 is a front elevation view thereof;
 FIG. 23.5 is a rear view thereof;
 FIG. 23.6 is a top plan view thereof;
 FIG. 23.7 is a bottom plan view thereof;
 FIG. 26.1 is a perspective view of an electronic cigarette, according to an eleventh embodiment of our new design;
 FIG. 26.2 is a right side view thereof;
 FIG. 26.3 is a left side view thereof;
 FIG. 26.4 is a front elevation view thereof;
 FIG. 26.5 is a rear view thereof;
 FIG. 26.6 is a top plan view thereof;
 FIG. 26.7 is a bottom plan view thereof;
 FIG. 27.1 is a perspective view of an electronic cigarette, according to a twelfth embodiment of our new design;
 FIG. 27.2 is a right side view thereof;

FIG. 27.3 is a left side view thereof;
 FIG. 27.4 is a front elevation view thereof;
 FIG. 27.5 is a rear view thereof;
 FIG. 27.6 is a top plan view thereof;
 FIG. 27.7 is a bottom plan view thereof;
 FIG. 30.1 is a perspective view of an electronic cigarette, according to a thirteenth embodiment of our new design;
 FIG. 30.2 is a right side view thereof;
 FIG. 30.3 is a left side view thereof;
 FIG. 30.4 is a front elevation view thereof;
 FIG. 30.5 is a rear view thereof;
 FIG. 30.6 is a top plan view thereof;
 FIG. 30.7 is a bottom plan view thereof;
 FIG. 31.1 is a perspective view of an electronic cigarette, according to a fourteenth embodiment of our new design;
 FIG. 31.2 is a right side view thereof;
 FIG. 31.3 is a left side view thereof;
 FIG. 31.4 is a front elevation view thereof;
 FIG. 31.5 is a rear view thereof;
 FIG. 31.6 is a top plan view thereof;
 FIG. 31.7 is a bottom plan view thereof;
 FIG. 37.1 is a perspective view of an electronic cigarette, according to a fifteenth embodiment of our new design;
 FIG. 37.2 is a left side view thereof;
 FIG. 37.3 is a right side view thereof;
 FIG. 37.4 is a rear elevation view thereof;
 FIG. 37.5 is a top plan view thereof;
 FIG. 38 is a perspective view of an electronic cigarettes, according to a sixteenth embodiment of our new design;
 FIG. 39 is a perspective view of an electronic cigarette, according to a seventeenth embodiment of our new design;
 FIG. 40 is a perspective view of electronic cigarette, according to an eighteenth embodiment of our new design; and
 FIG. 41 is a perspective view of an electronic cigarette, according to a nineteenth embodiment of our new design.
 The broken lines of even length represent portions of the electronic cigarette that form no part of the claimed design.

**1 Claim, 107 Drawing Sheets
 (2 of 107 Drawing Sheet(s) Filed in Color)**

(56)

References Cited

U.S. PATENT DOCUMENTS

D884,265 S *	5/2020	Wright	D27/162
D914,278 S *	3/2021	Luo	D27/162
D945,696 S *	3/2022	Simpson	D27/162
D952,937 S *	5/2022	Ouyang	D27/162
D953,617 S *	5/2022	Liu	D27/162

OTHER PUBLICATIONS

European Union Intellectual Property Office Community Design Application Nos. 06910139-0001 through 006910139-0032, filed on Sep. 24, 2019, entitled "Electronic Cigarettes". 10 pgs.
 Hague International Design Registration No. DM/209145; filed on Mar. 24, 2020; entitled "Electronic Cigarette". 133 pgs.

* cited by examiner

3.1

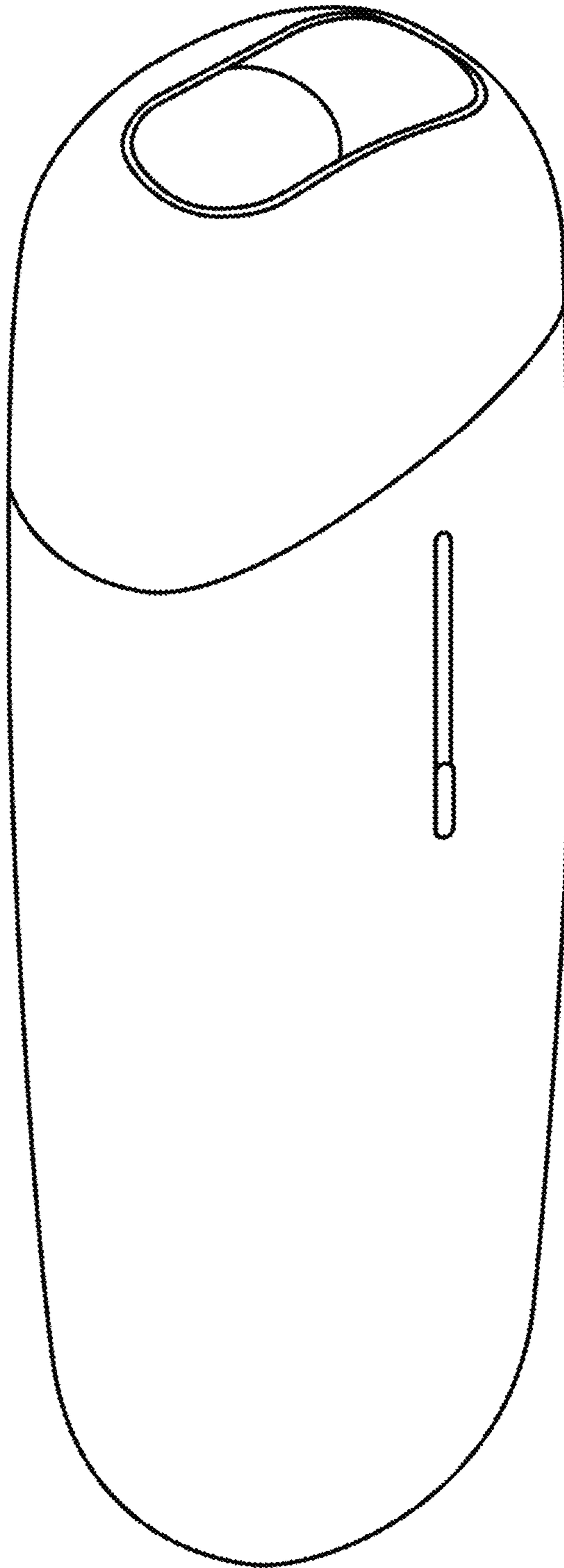

3.2

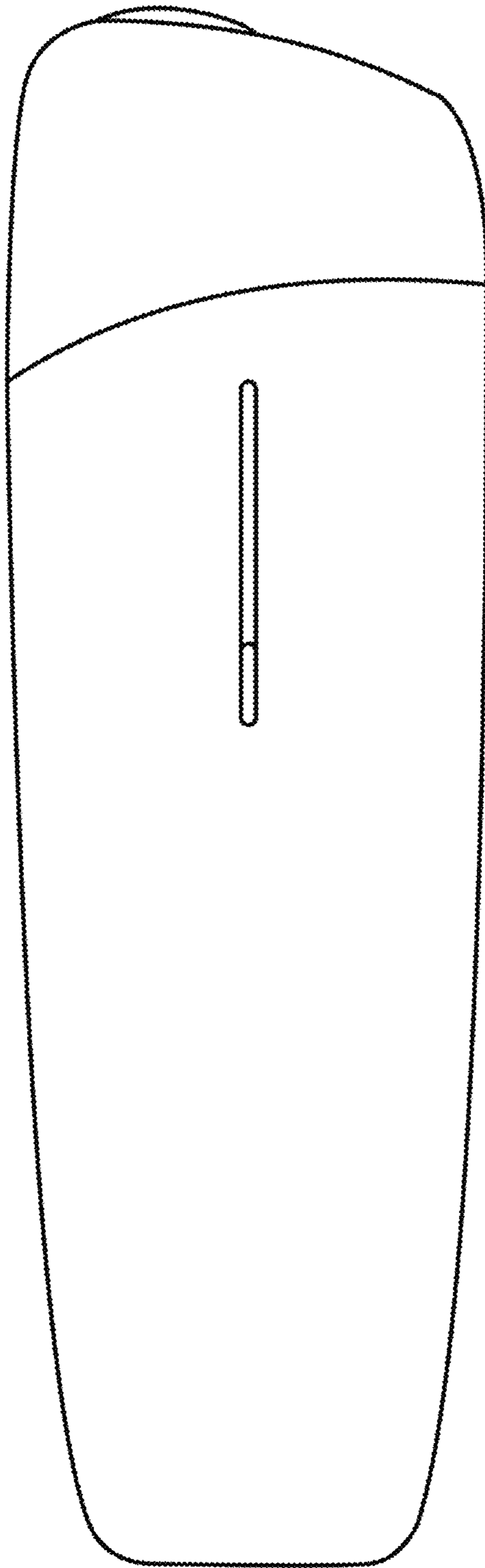

3.3

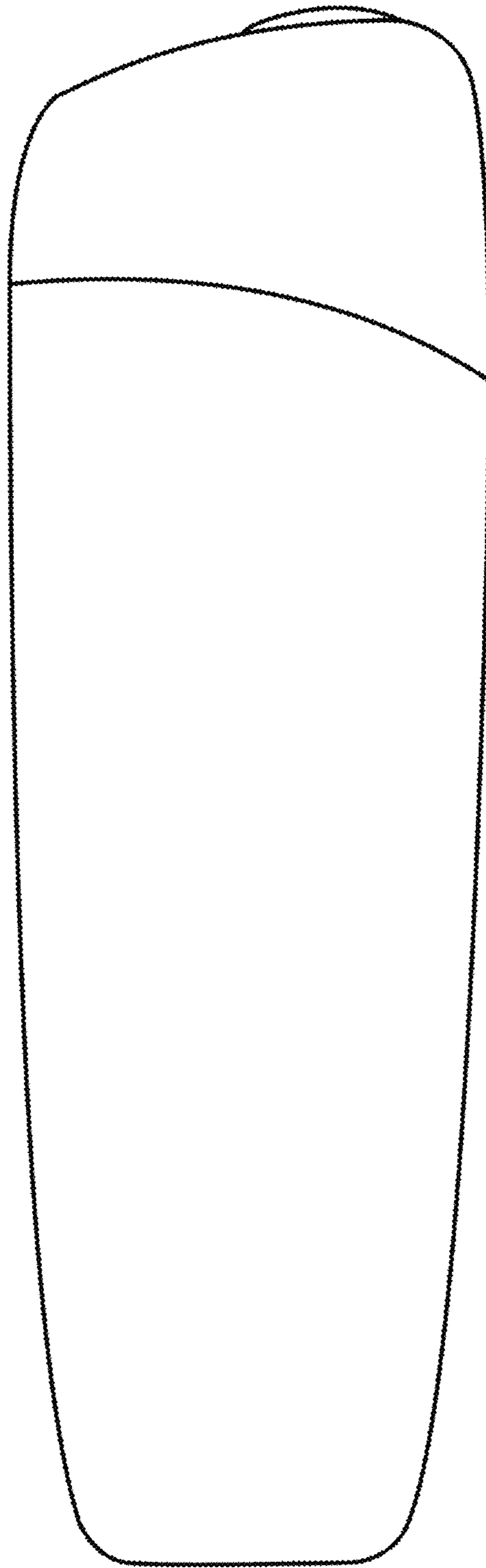

3.4

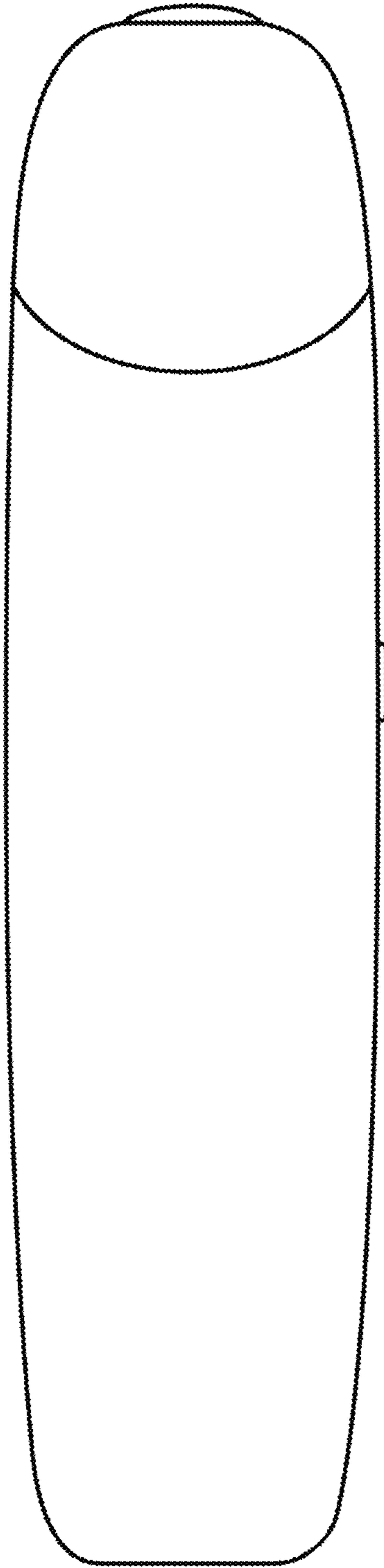

3.5

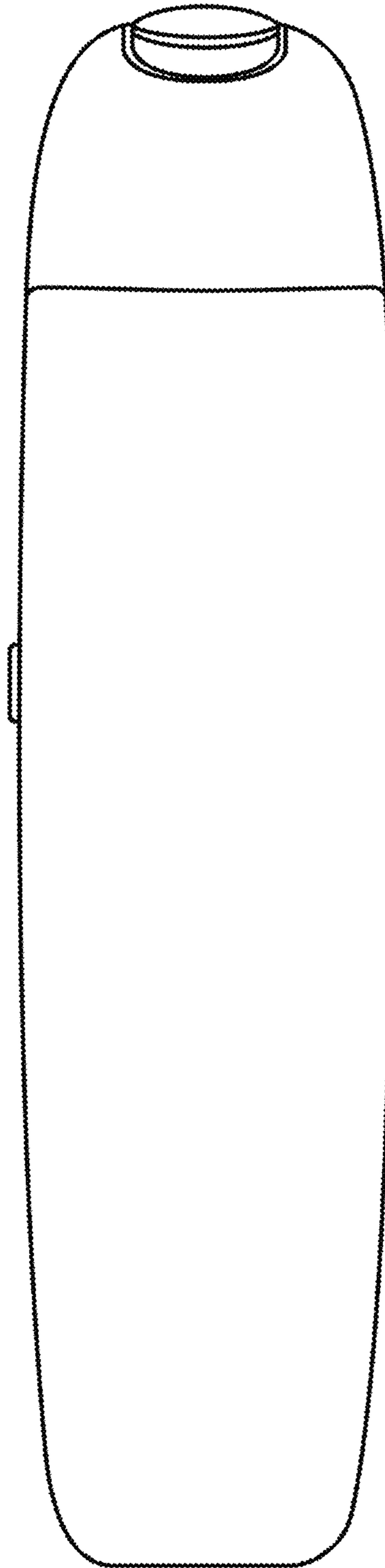

3.6

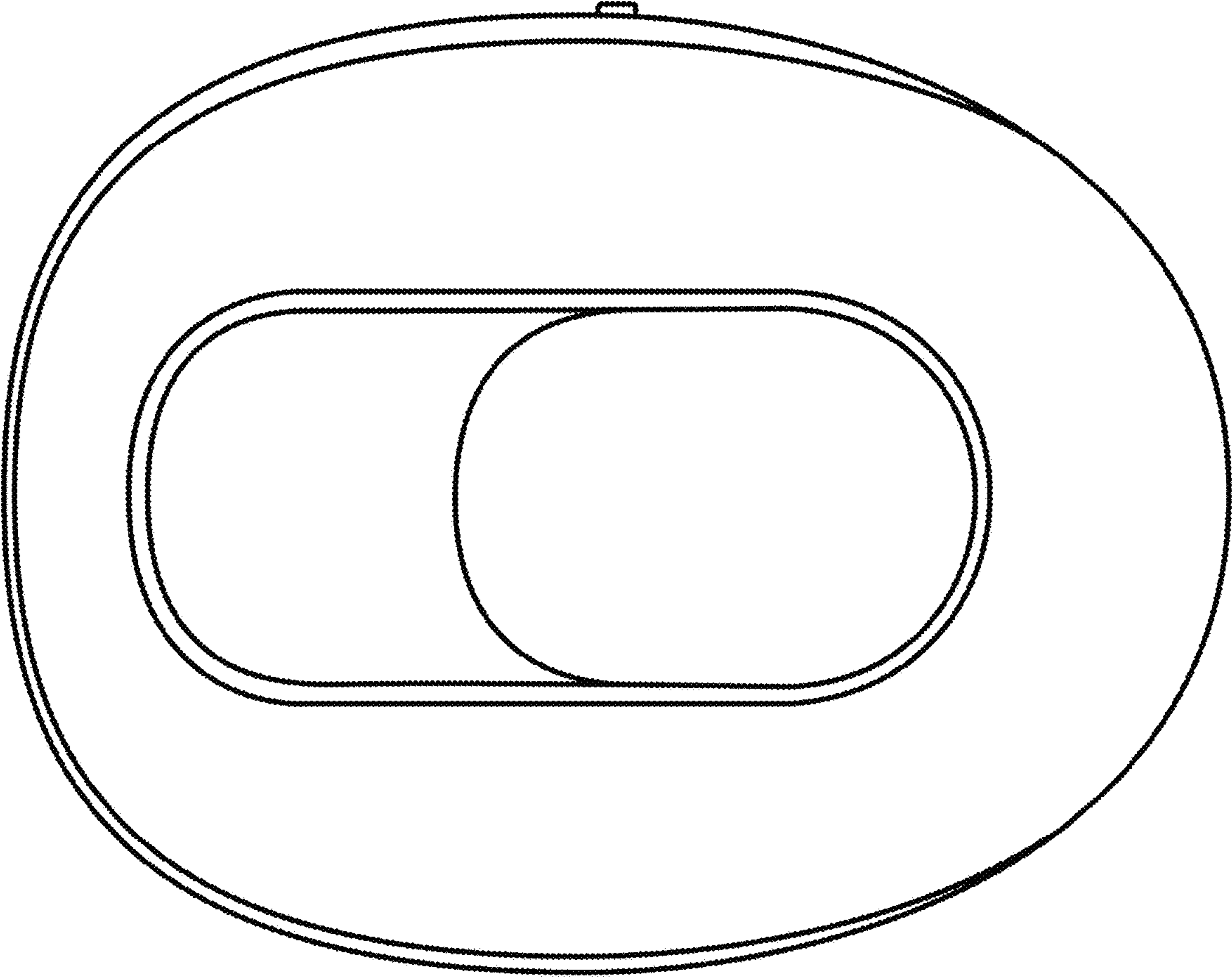

3.7

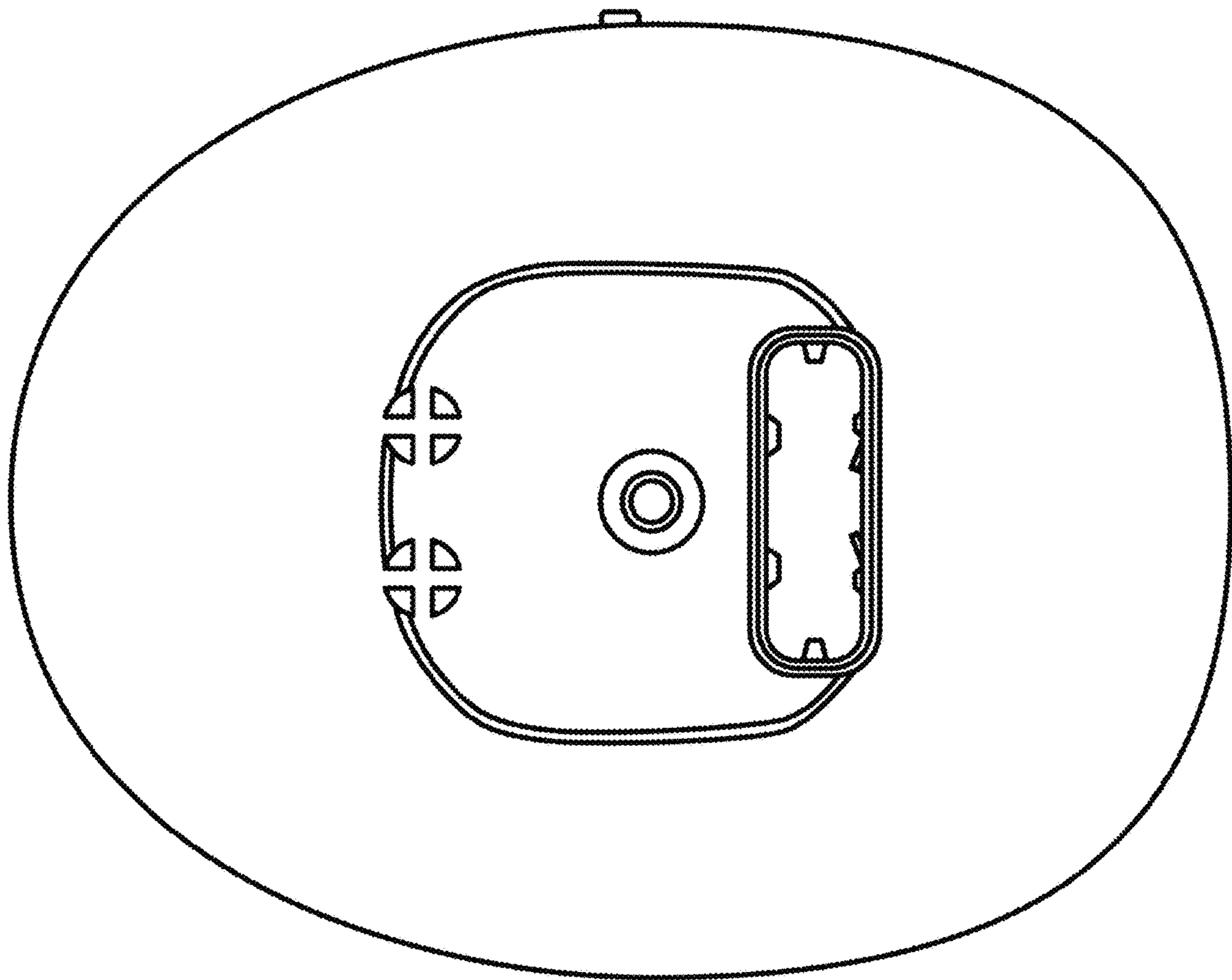

4.1

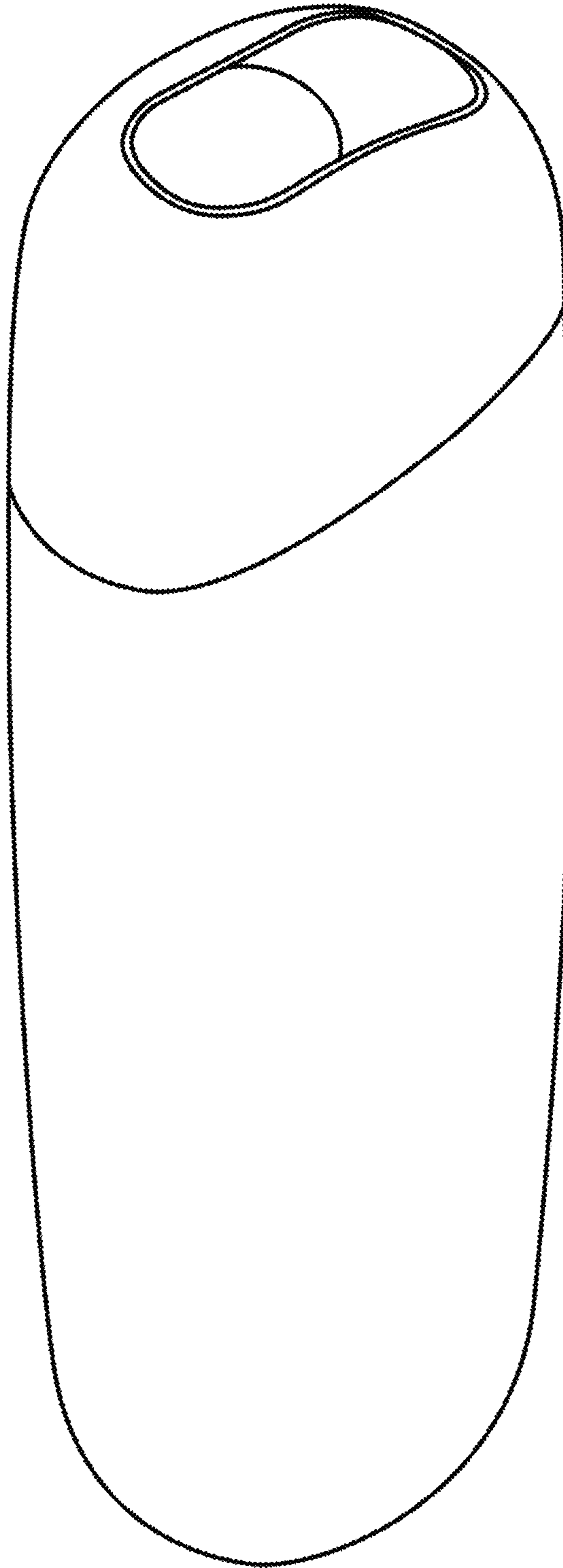

4.2

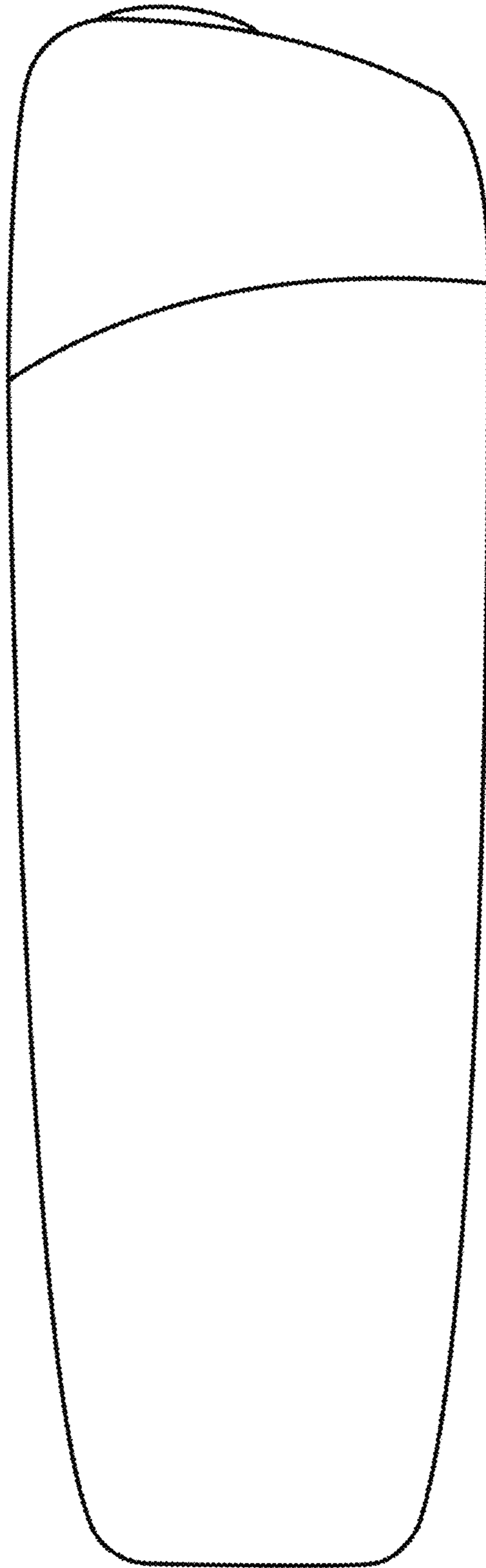

4.3

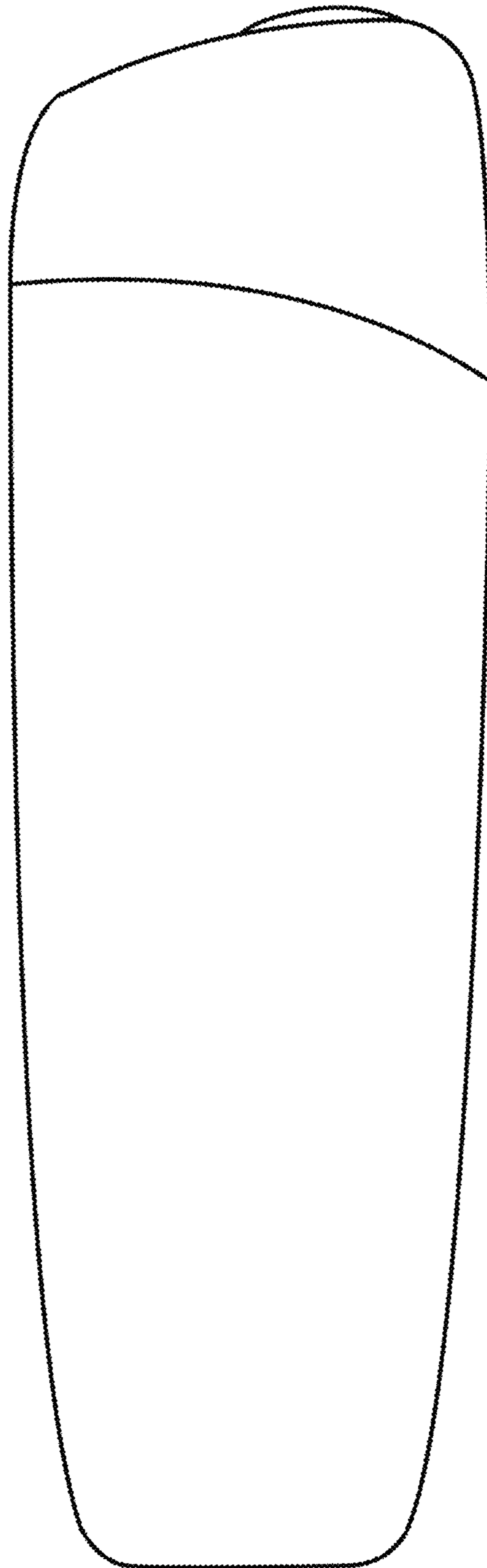

4.4

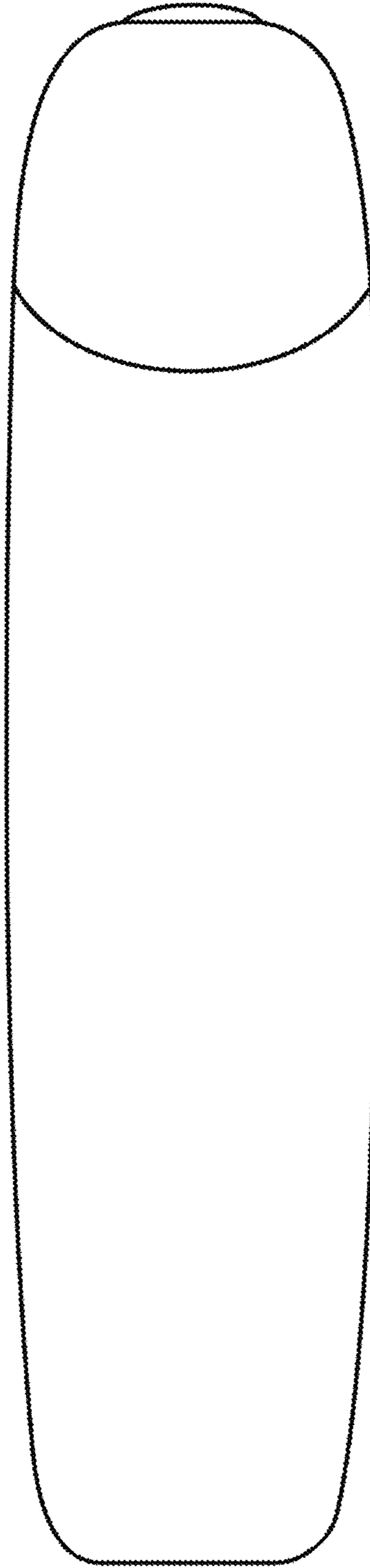

4.5

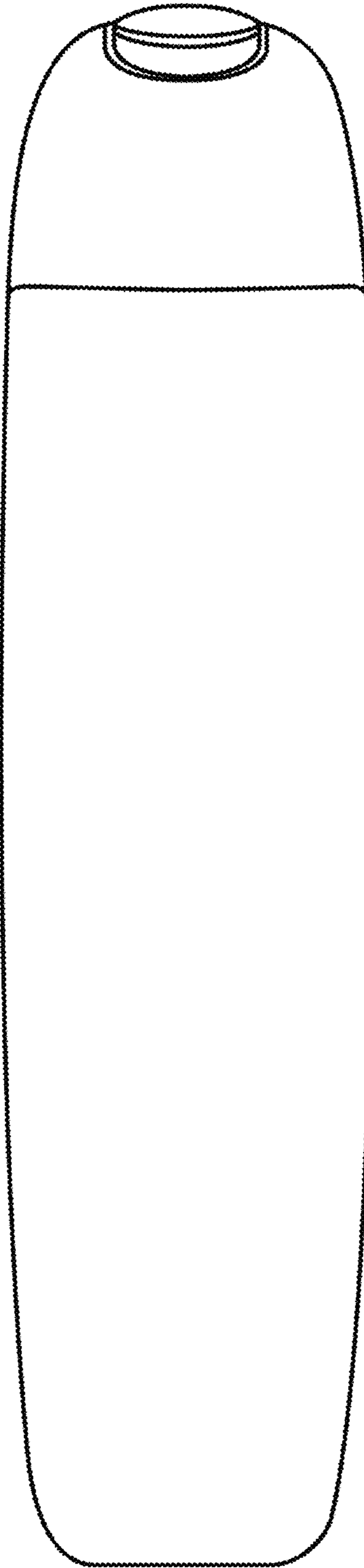

4.6

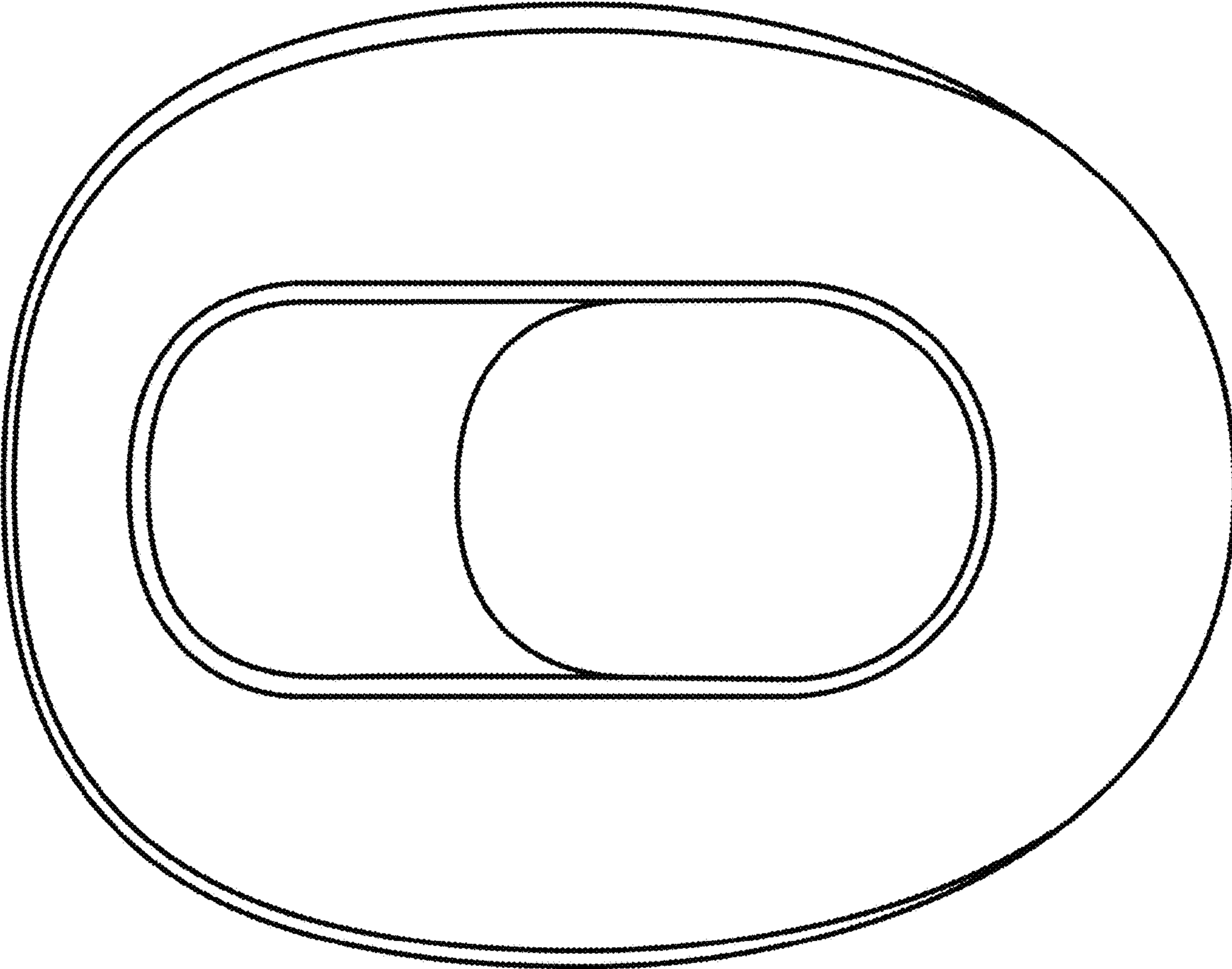

4.7

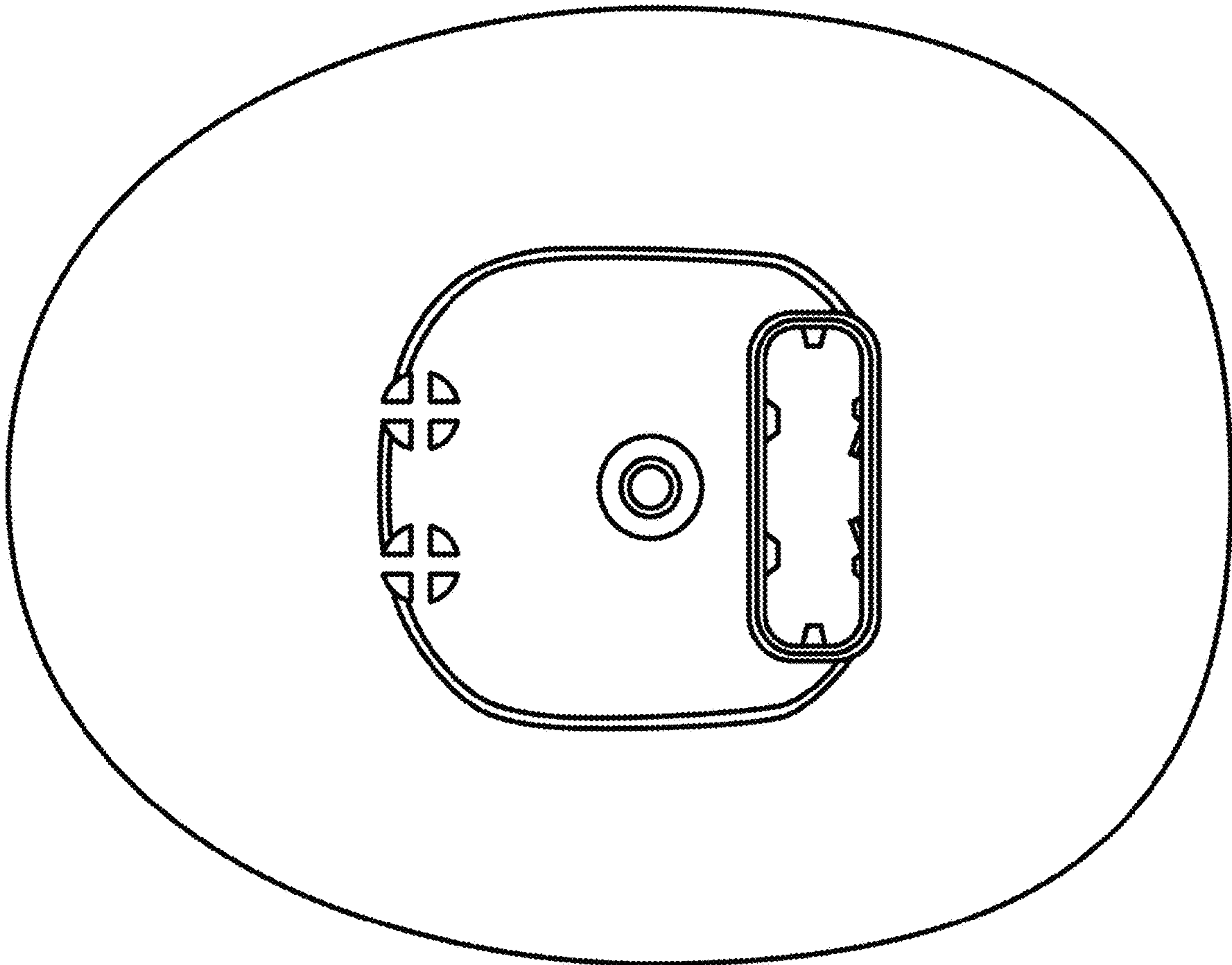

7.1

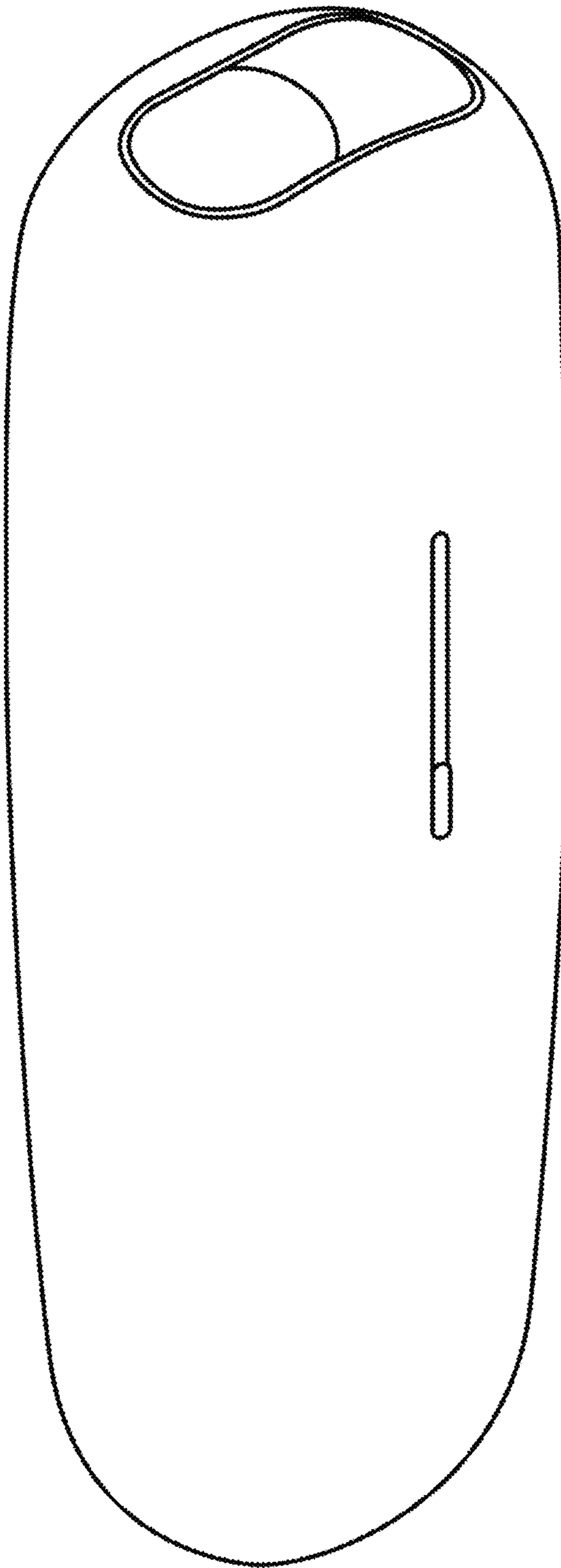

7.2

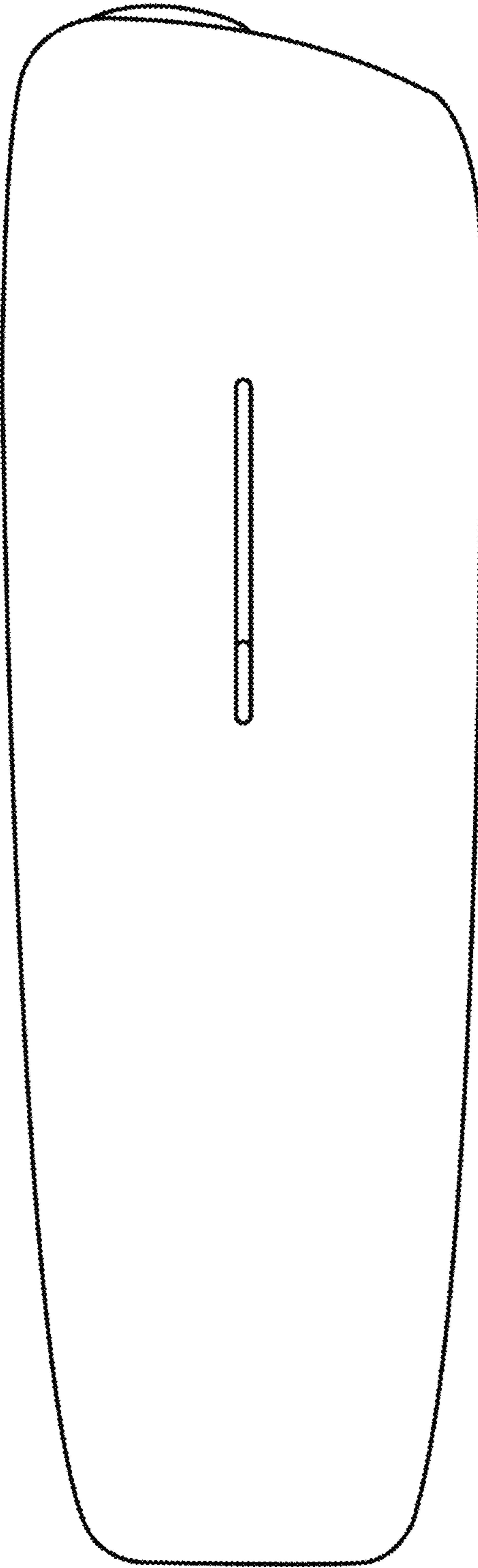

7.3

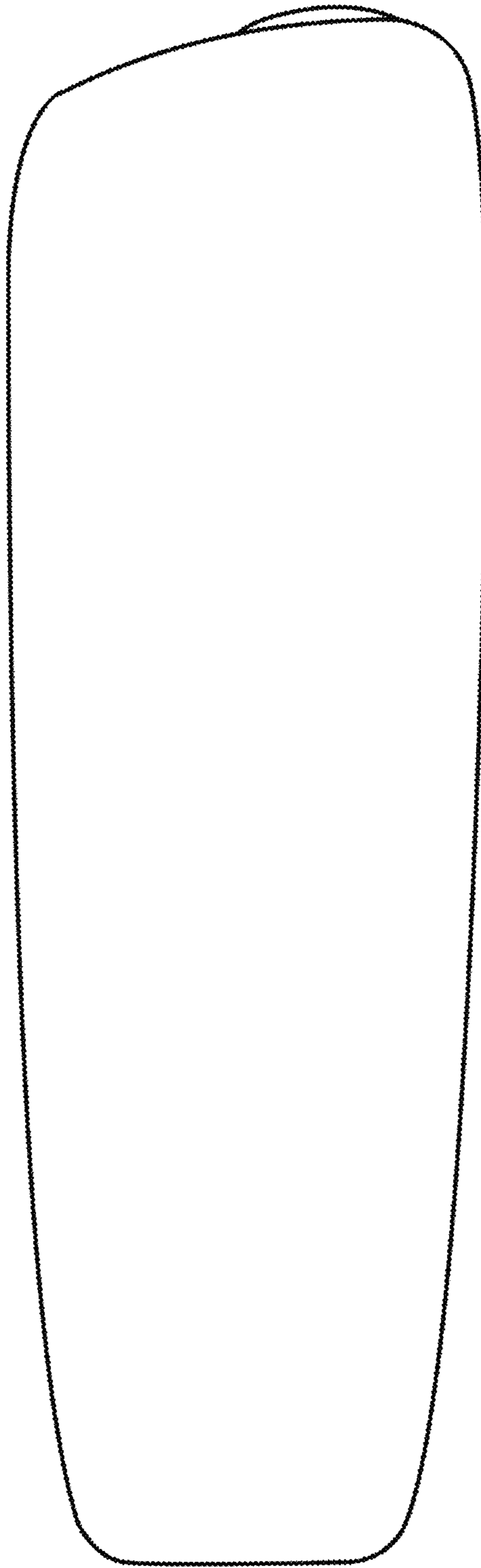

7.4

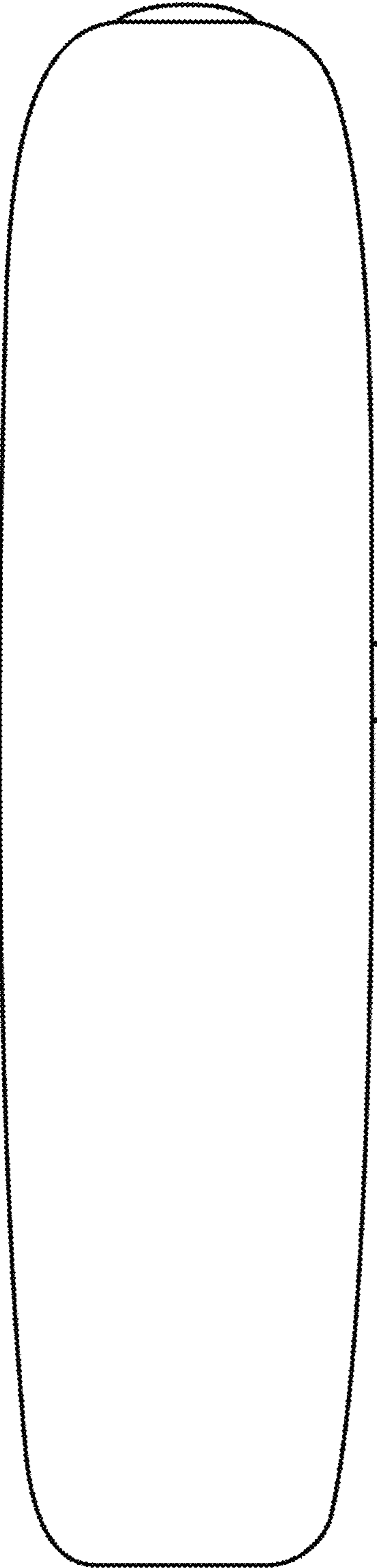

7.5

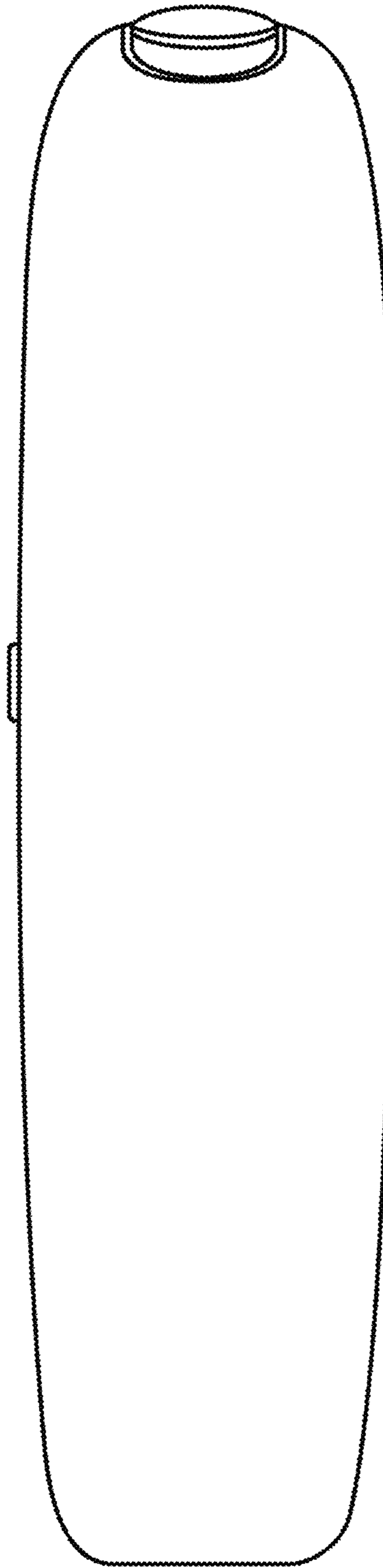

7.6

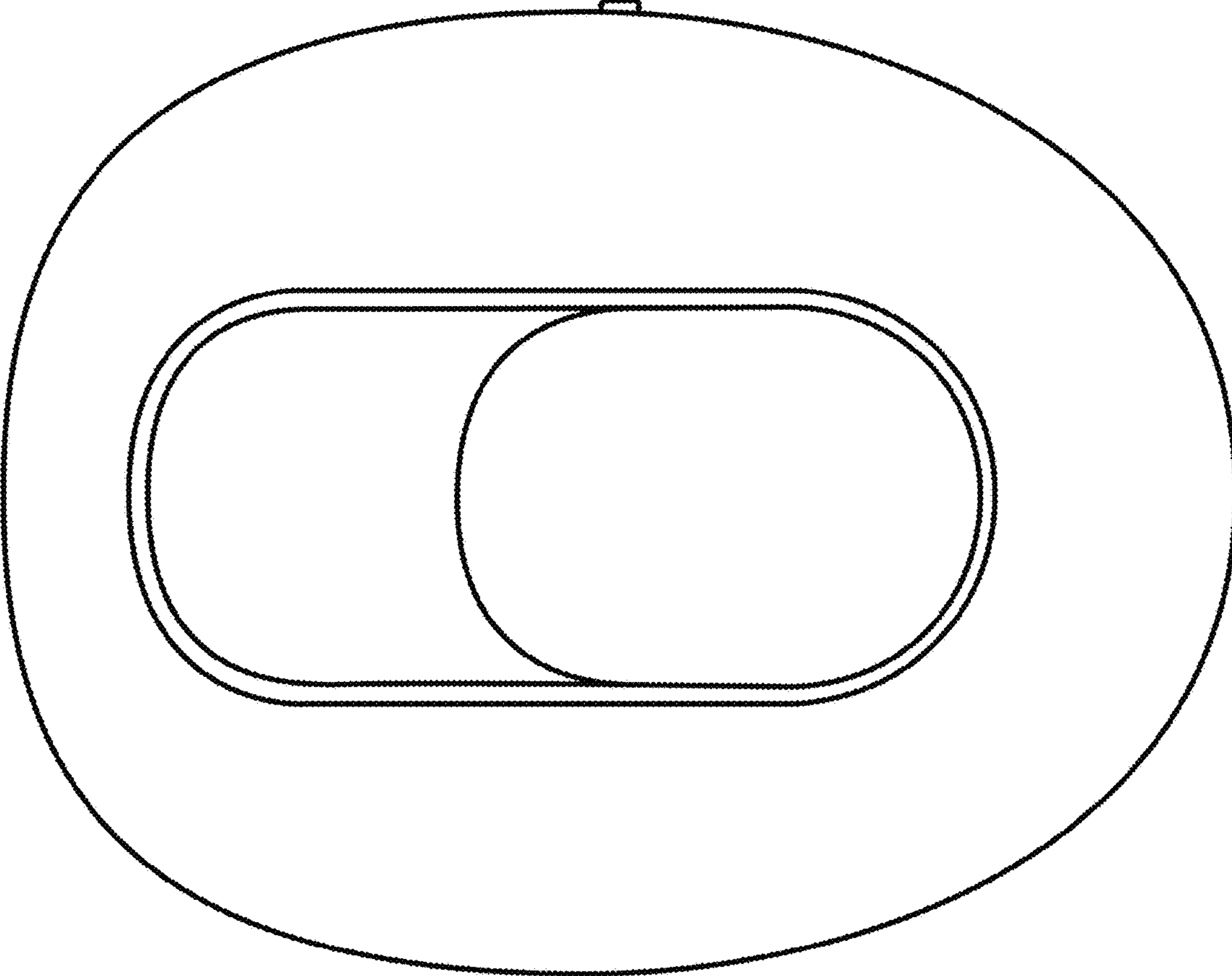

7.7

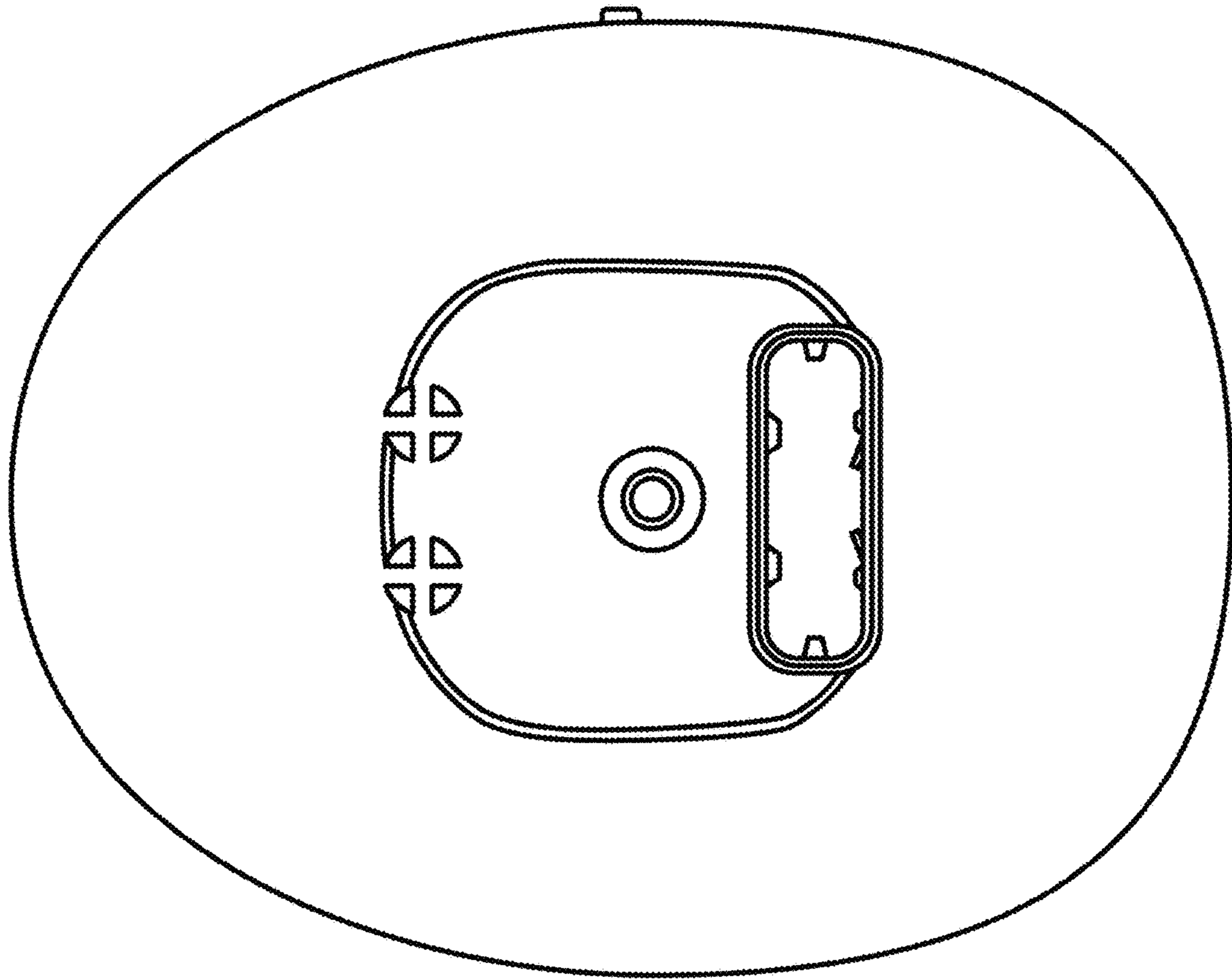

8.1

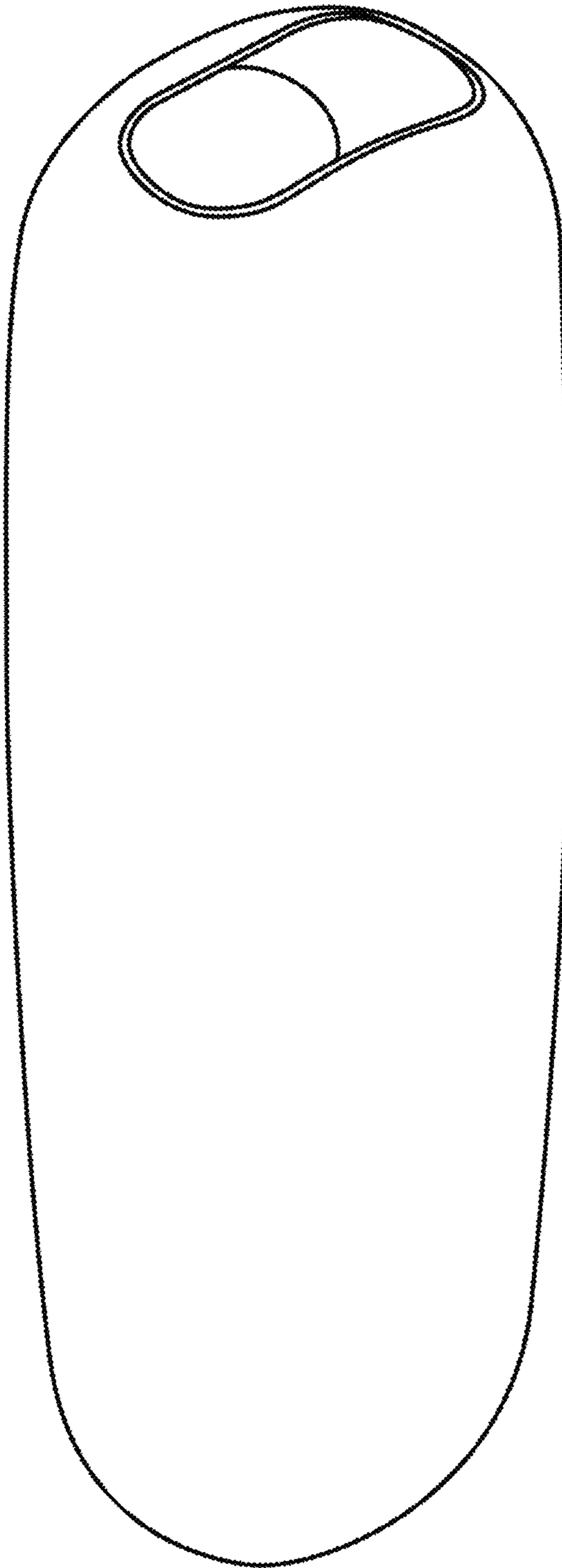

8.2

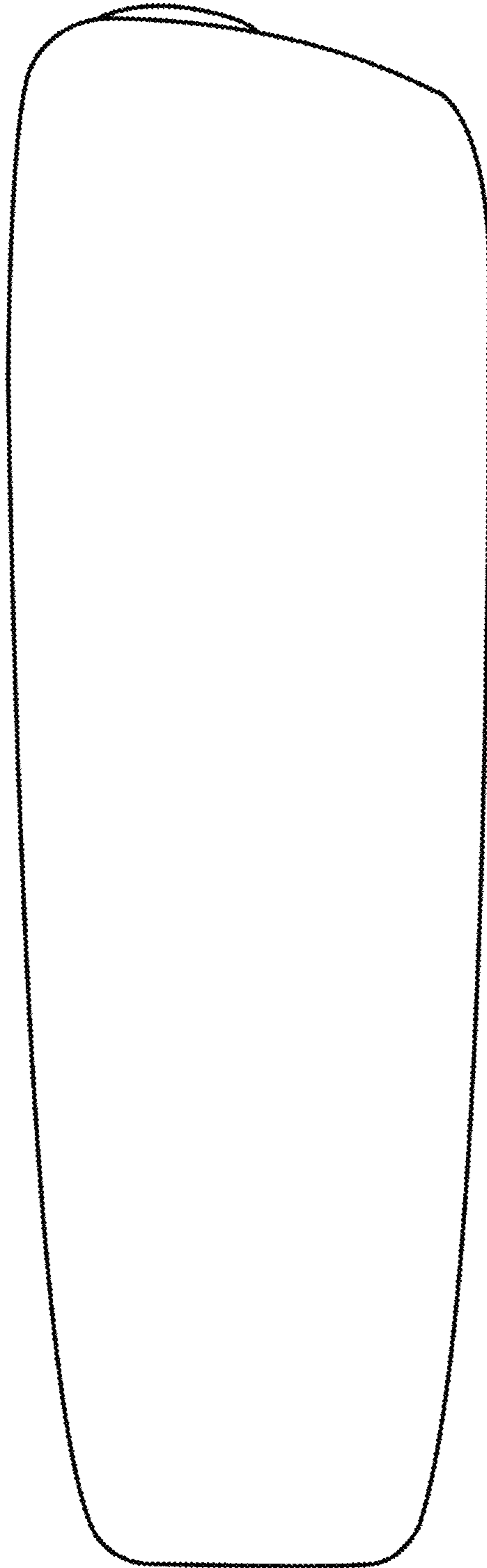

8.3

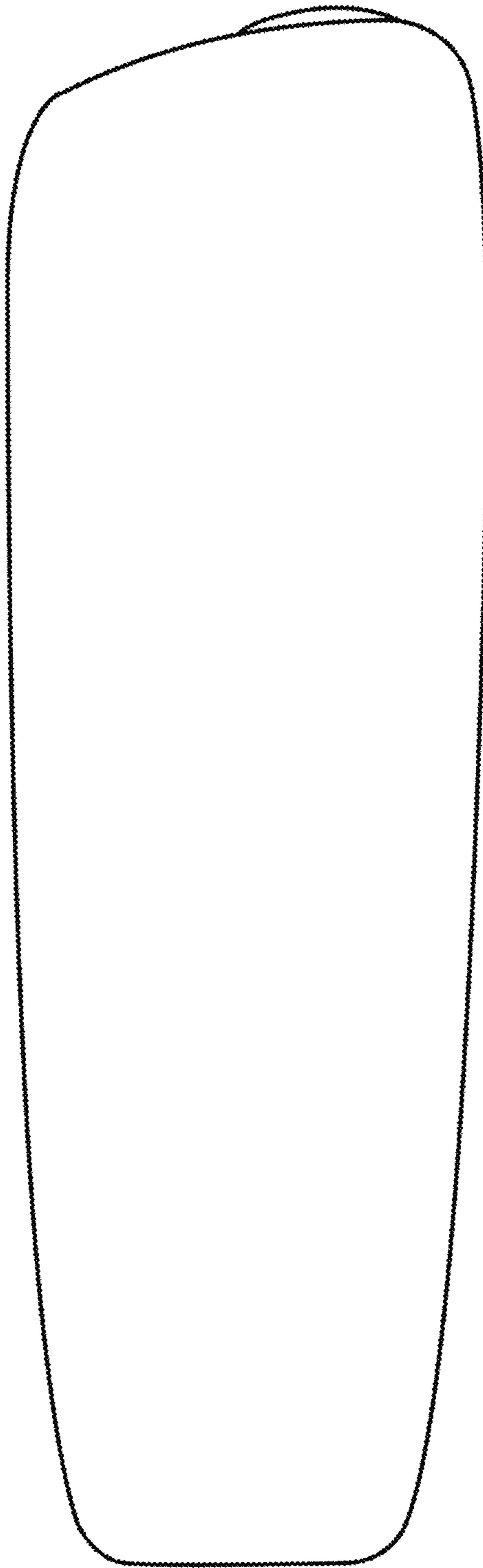

8.4

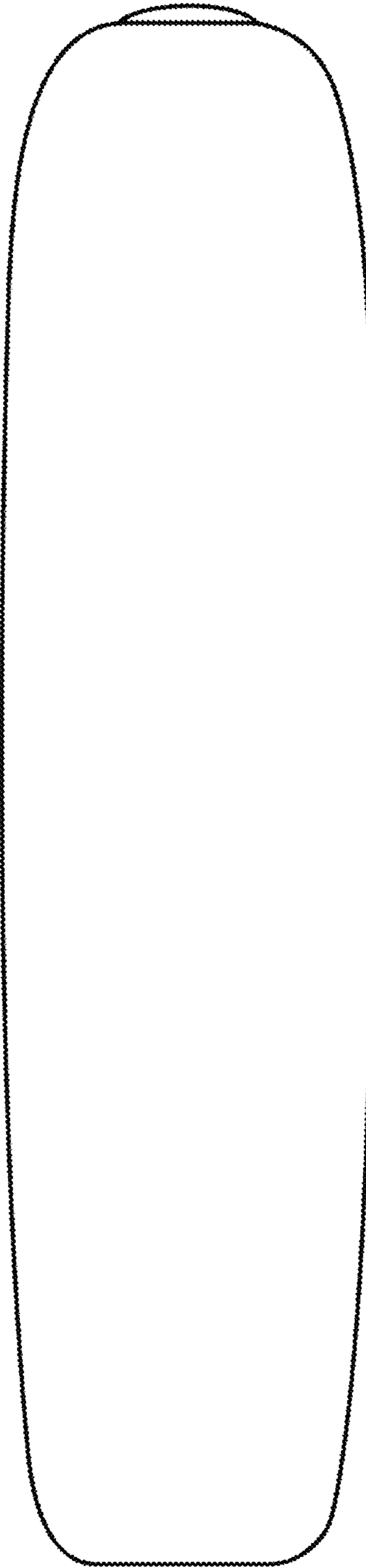

8.5



8.6

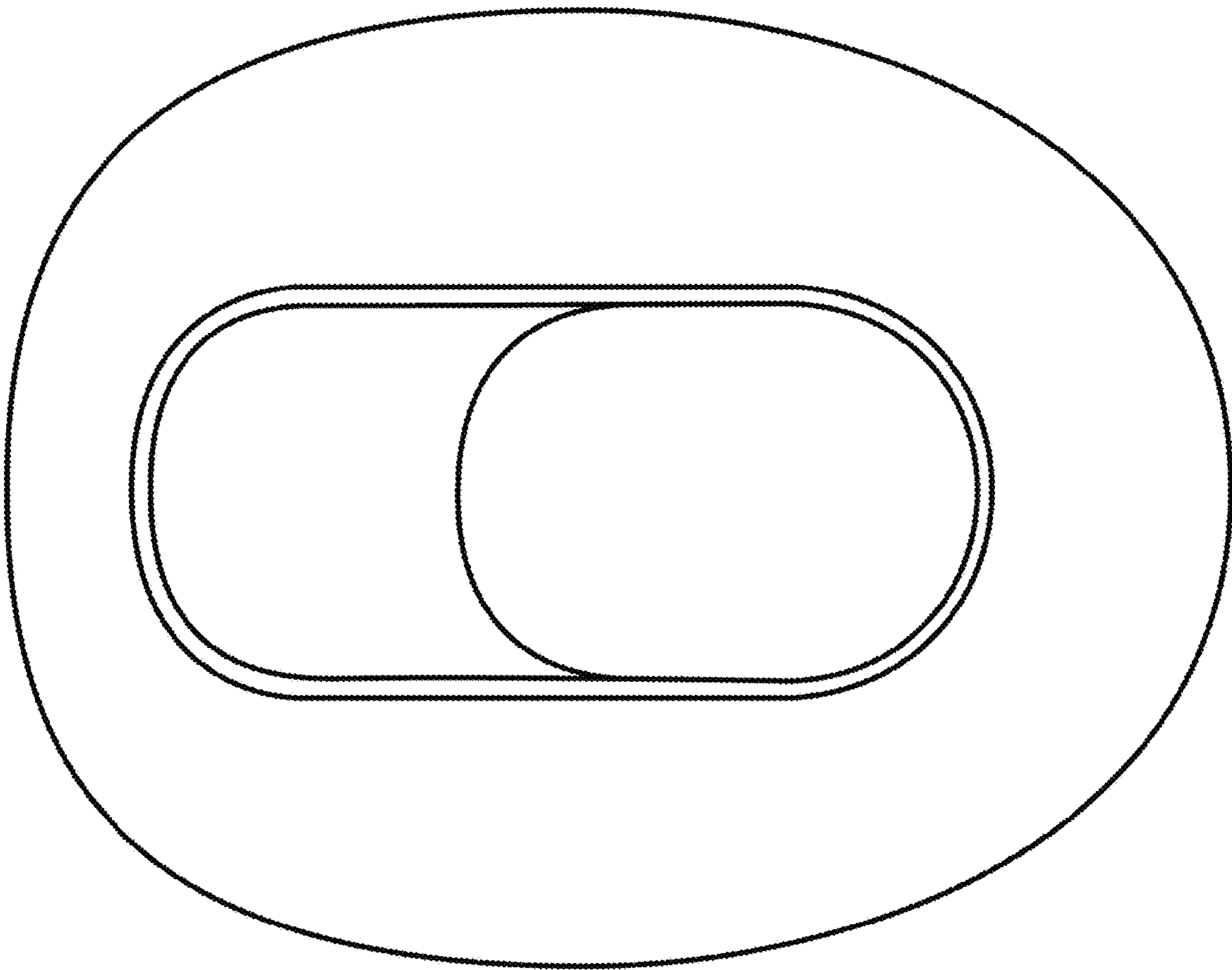

8.7

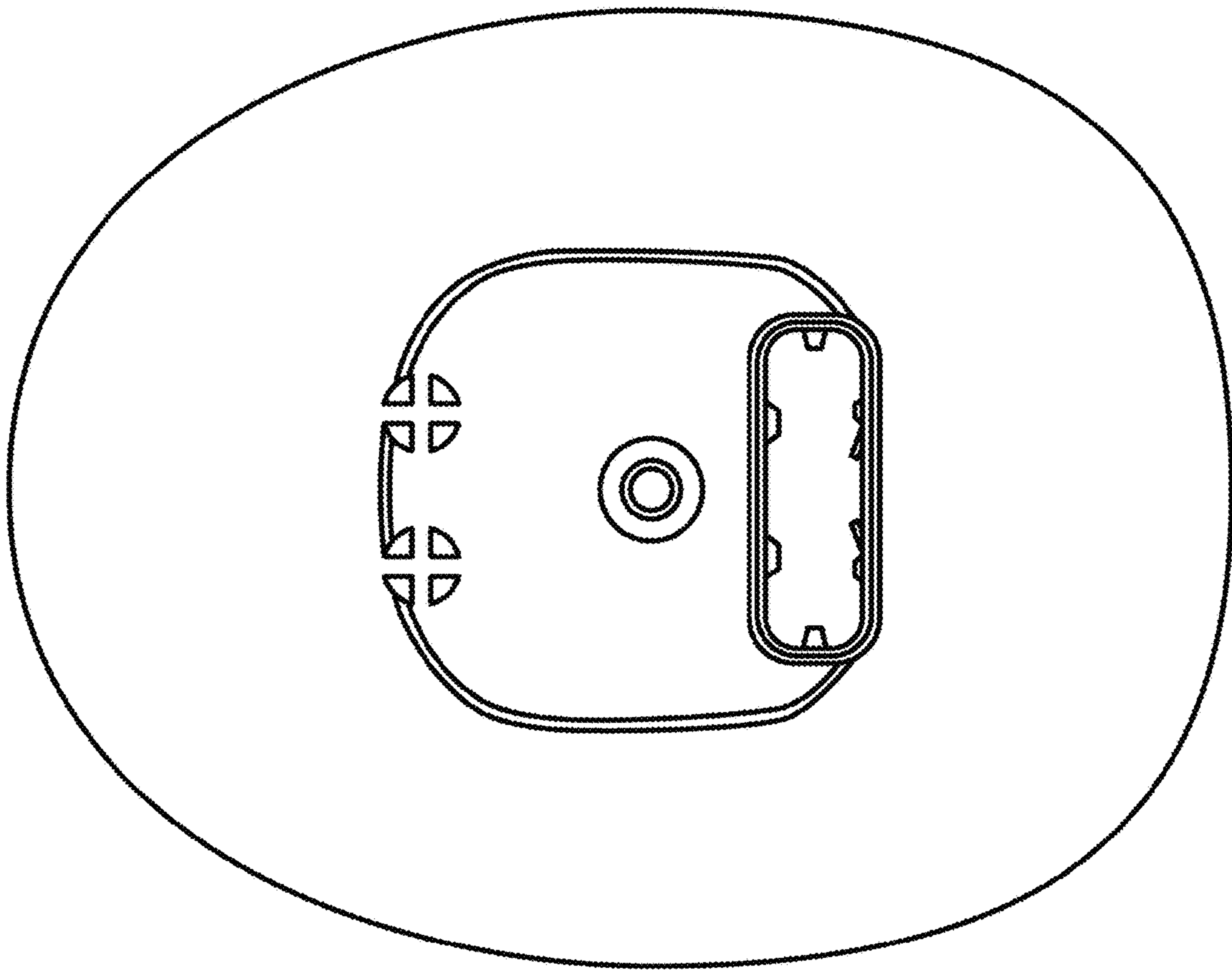

11.1

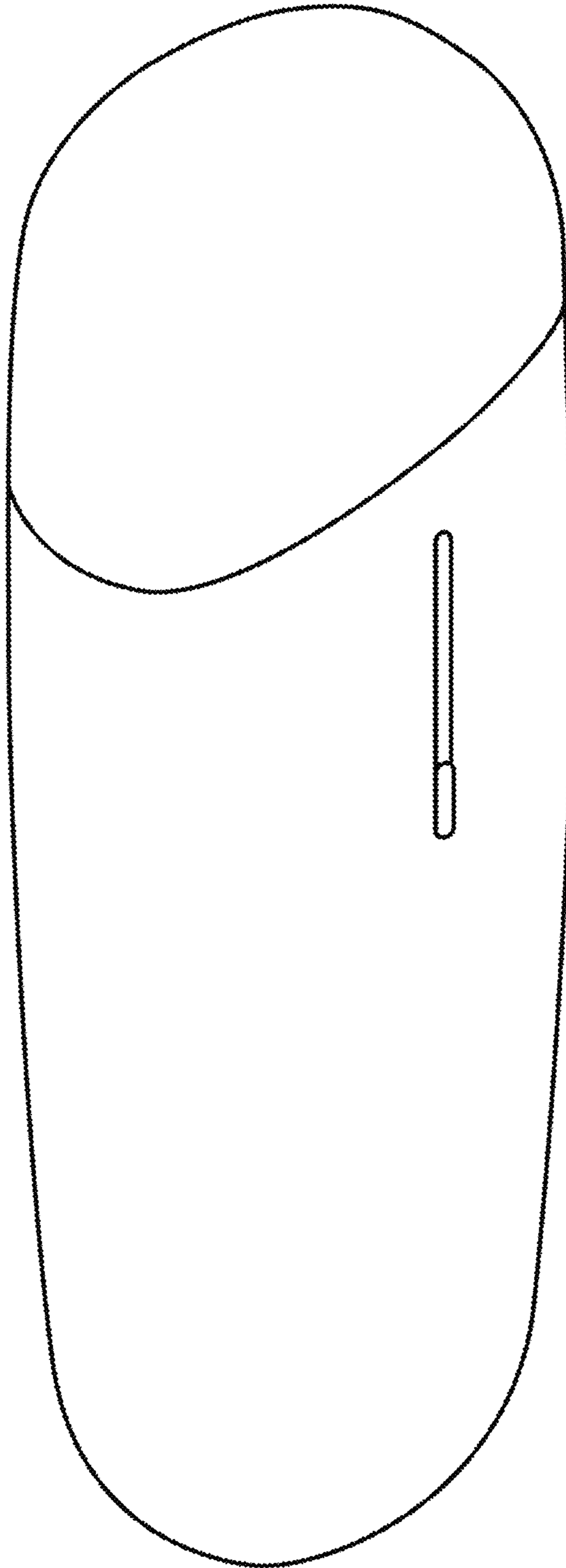

11.2

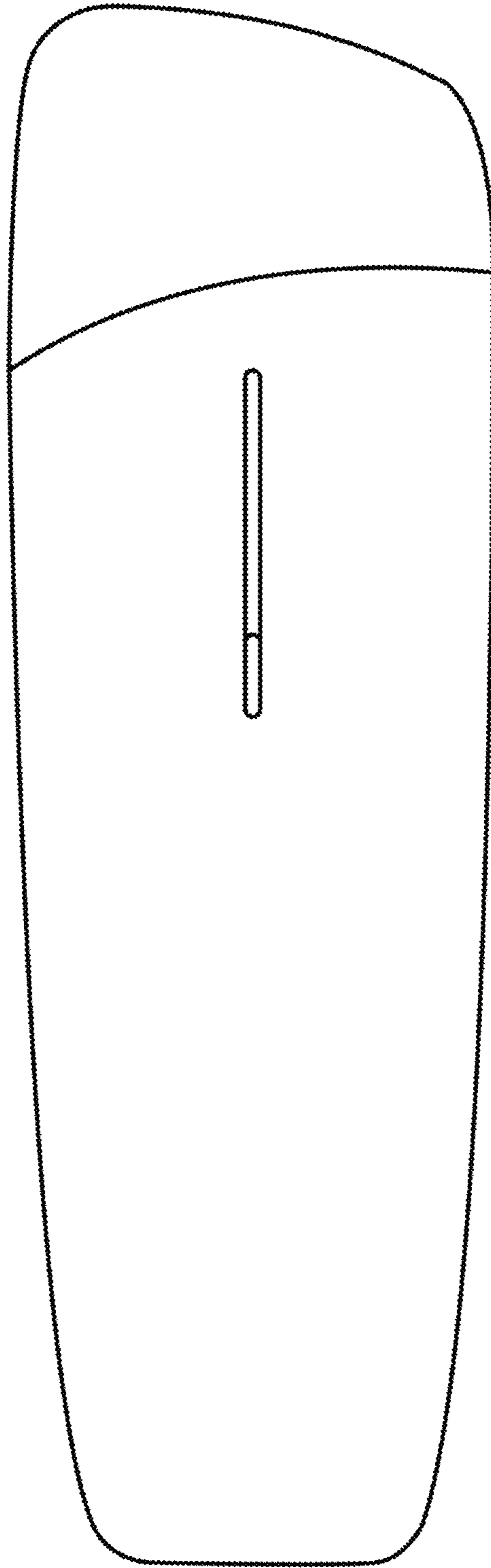

11.3

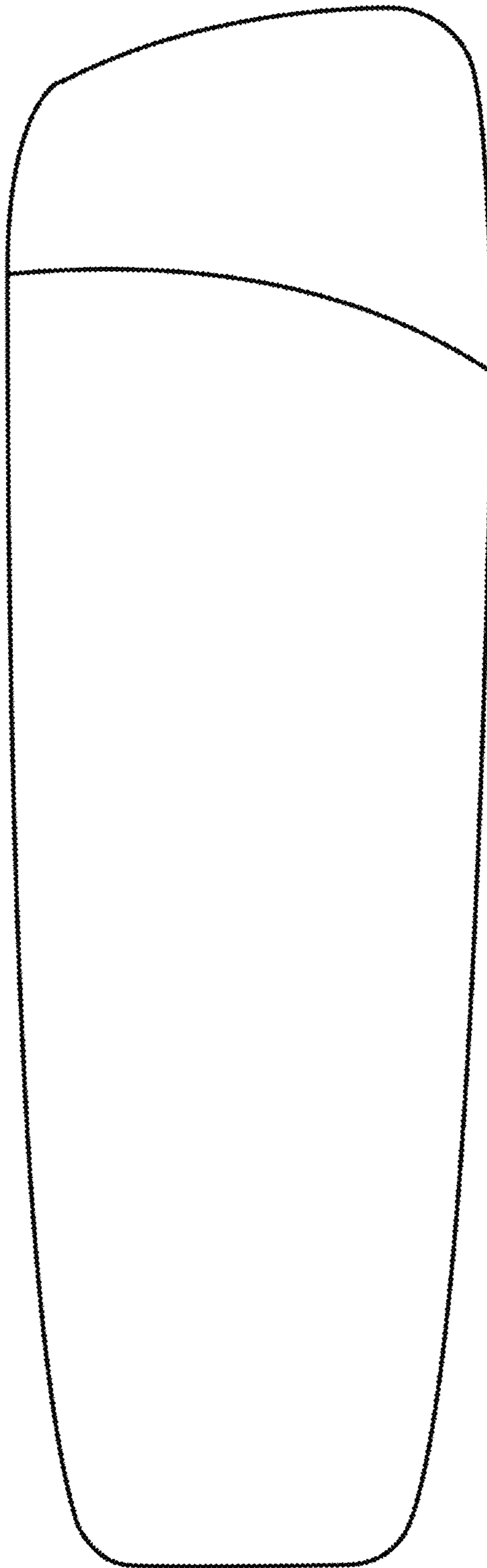

11.4

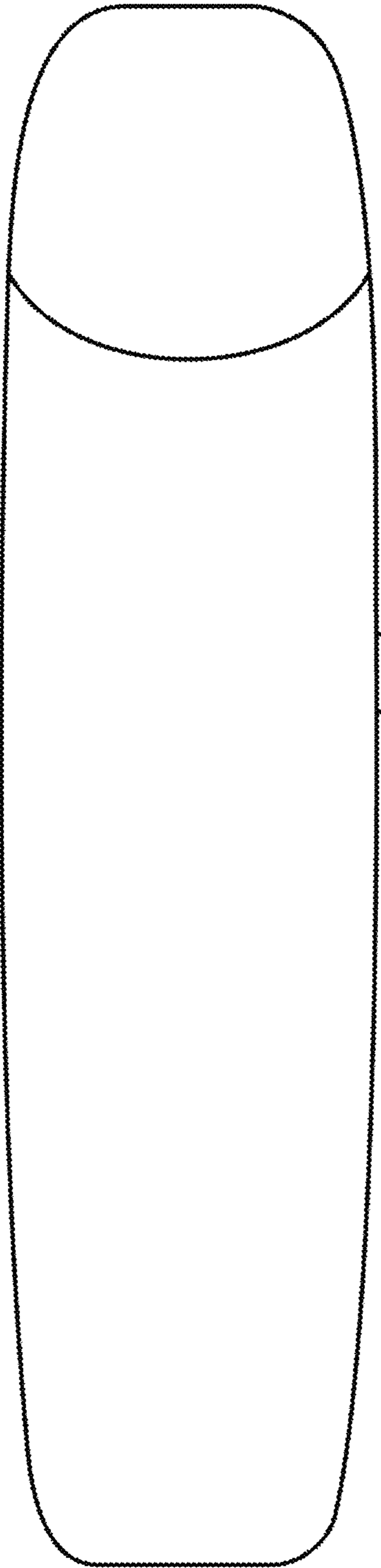

11.5

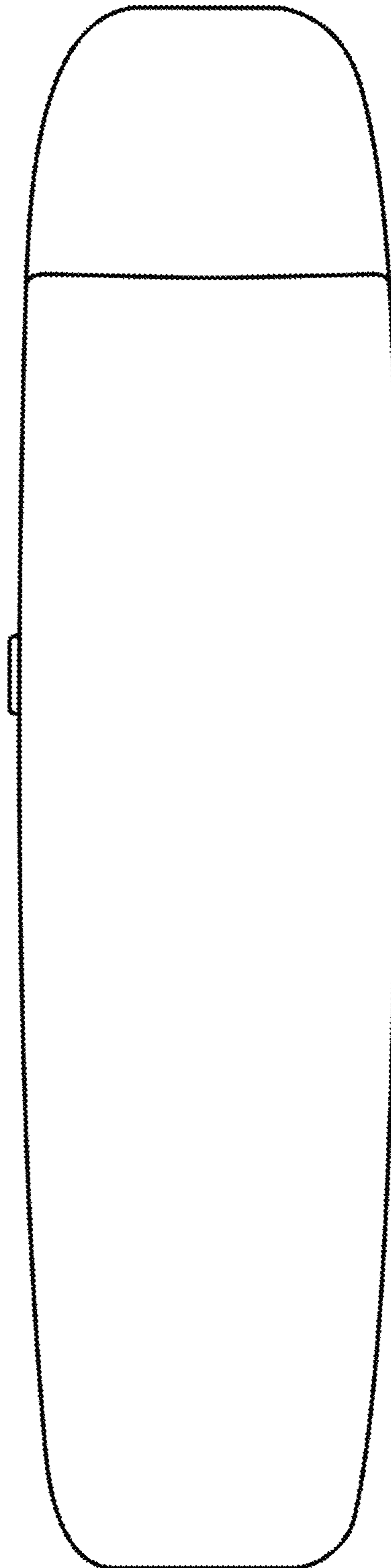

11.6

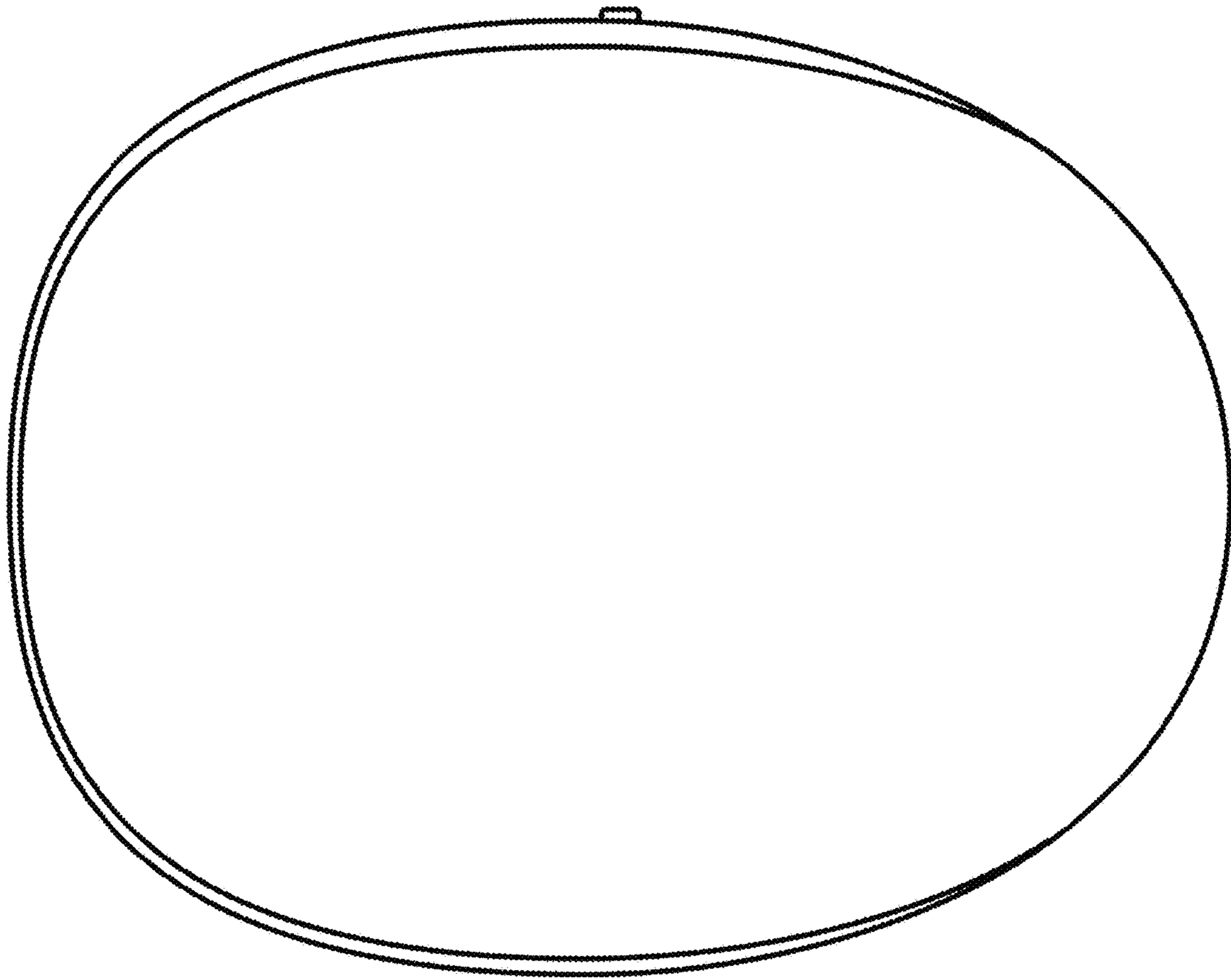

11.7

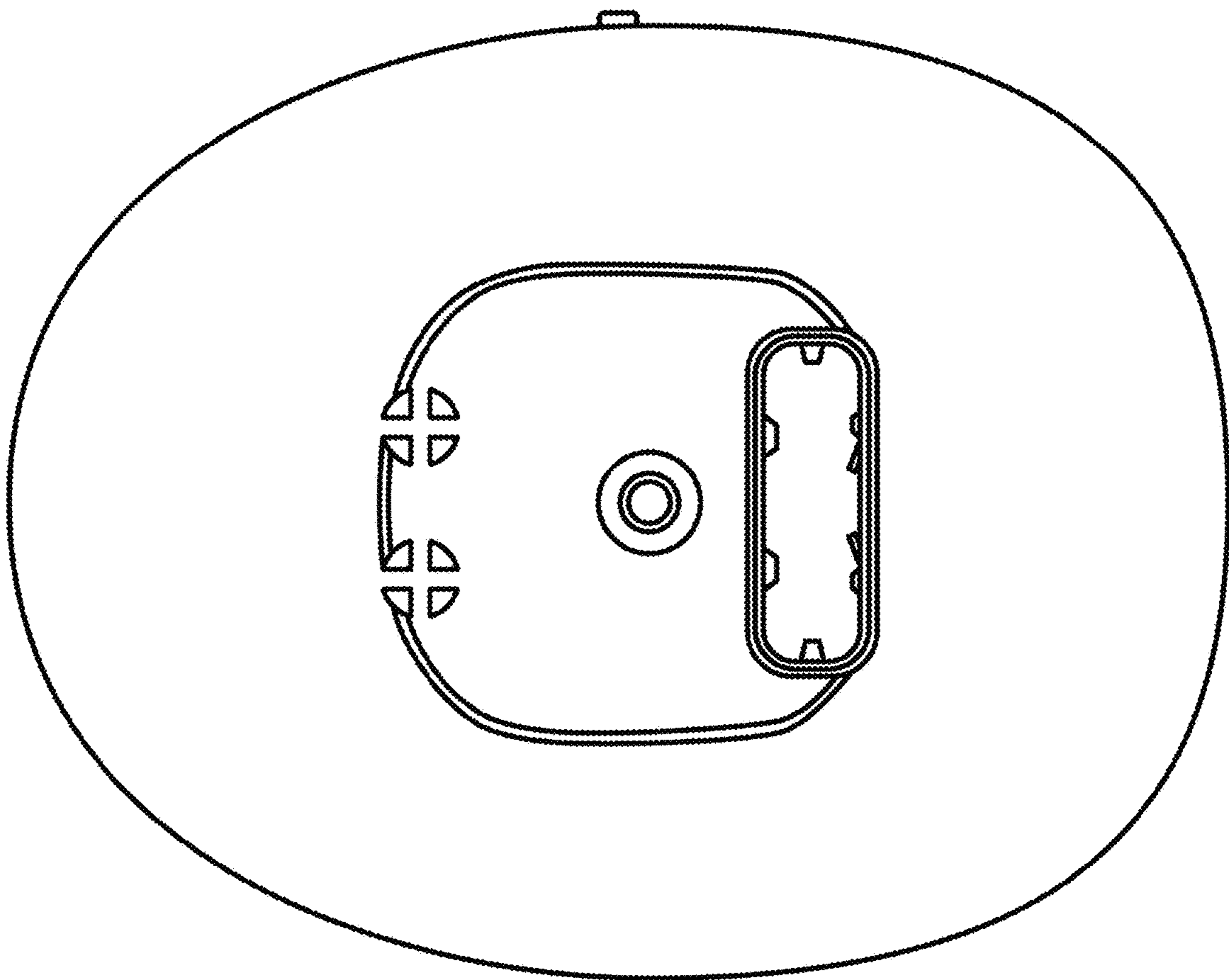

12.1

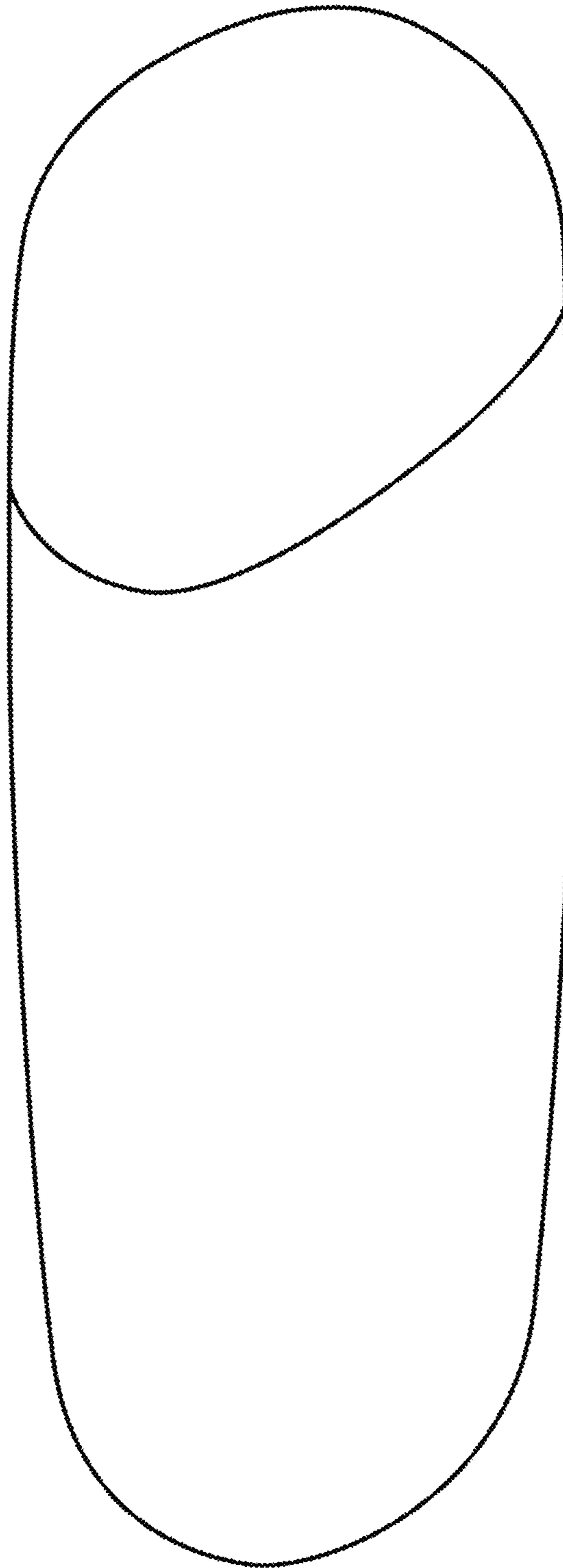

12.2

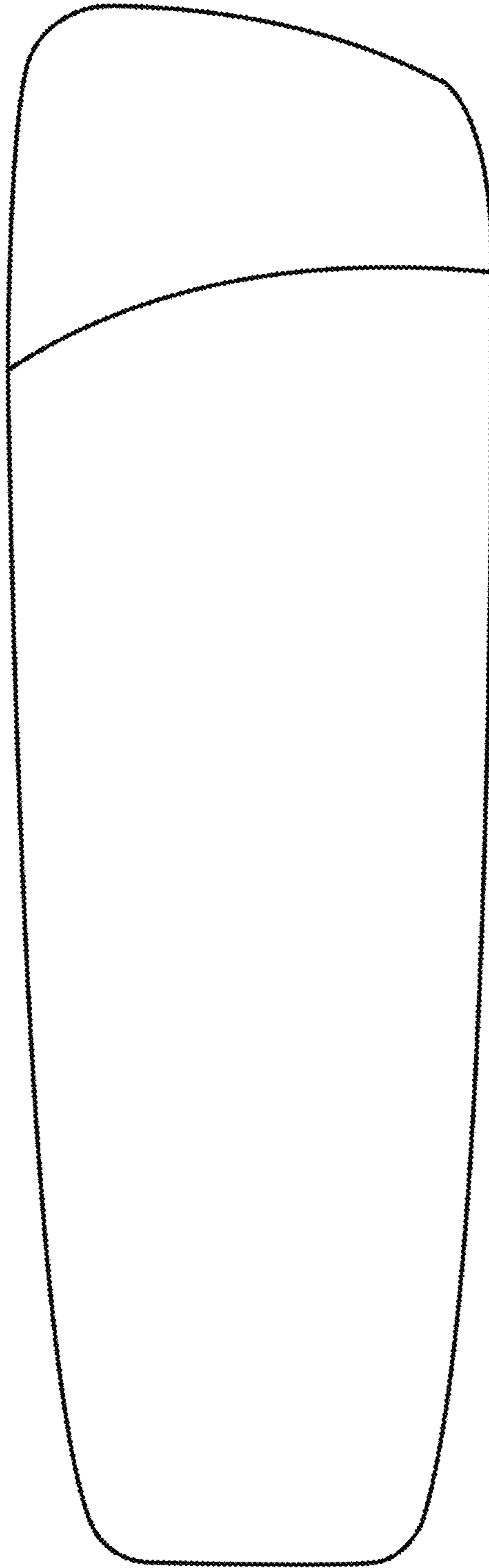

12.3

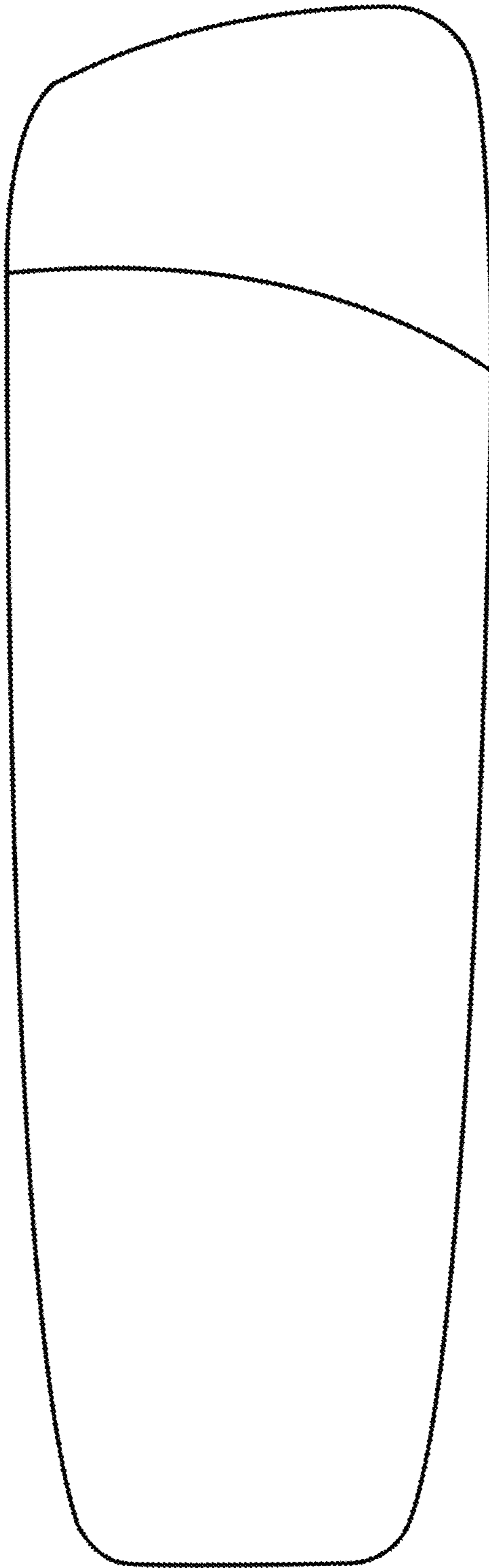

12.4

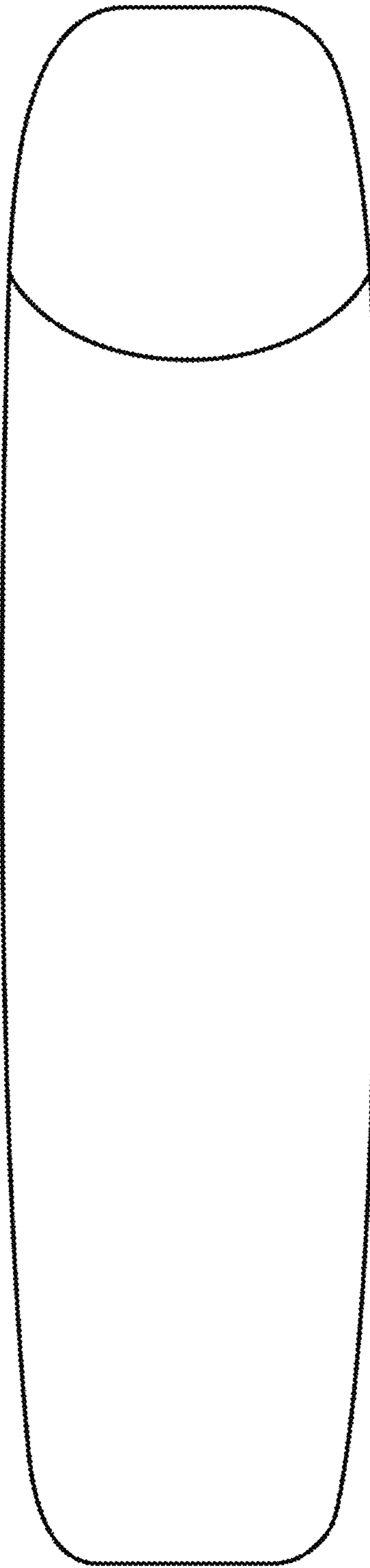

12.5



12.6

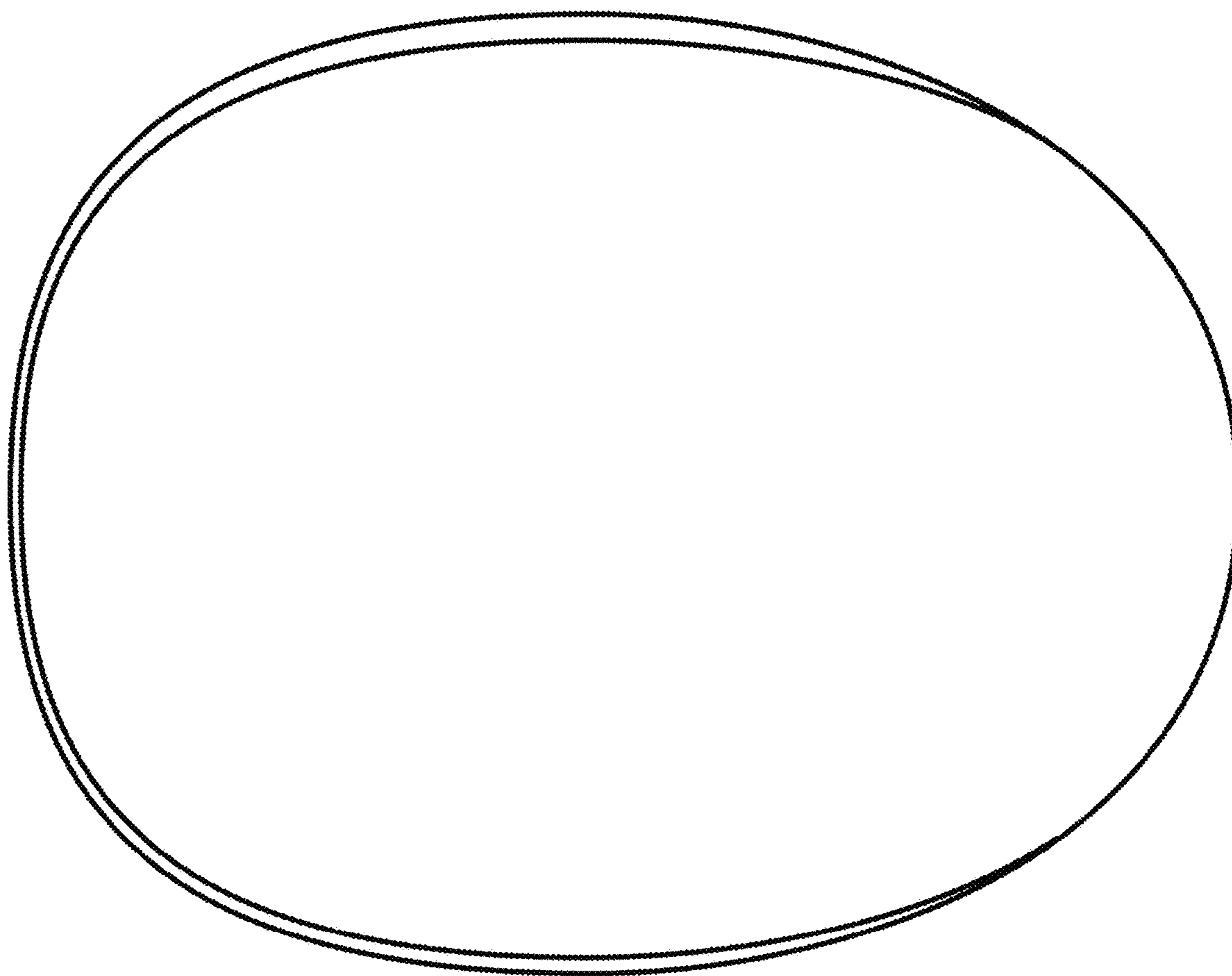

12.7

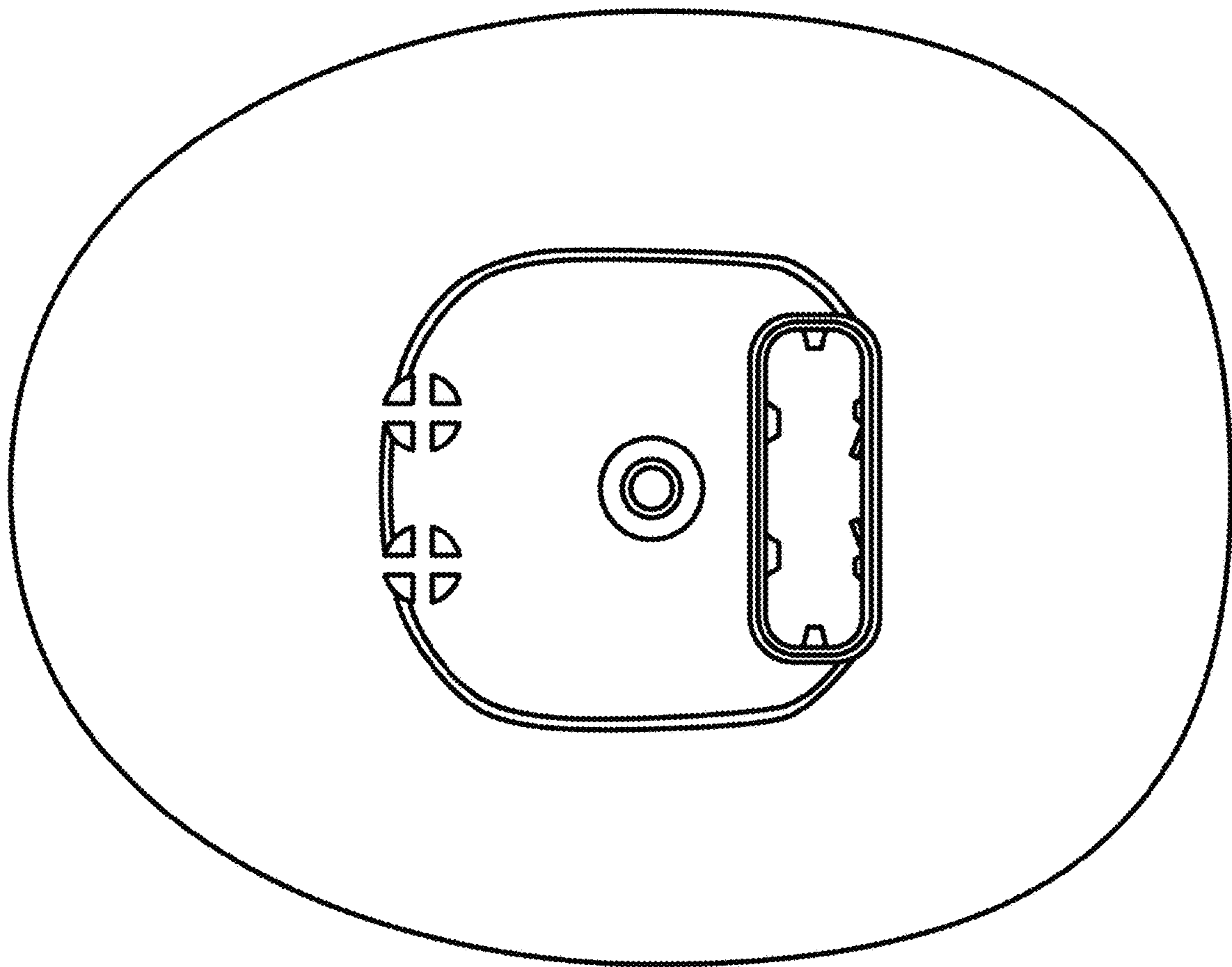

18.1

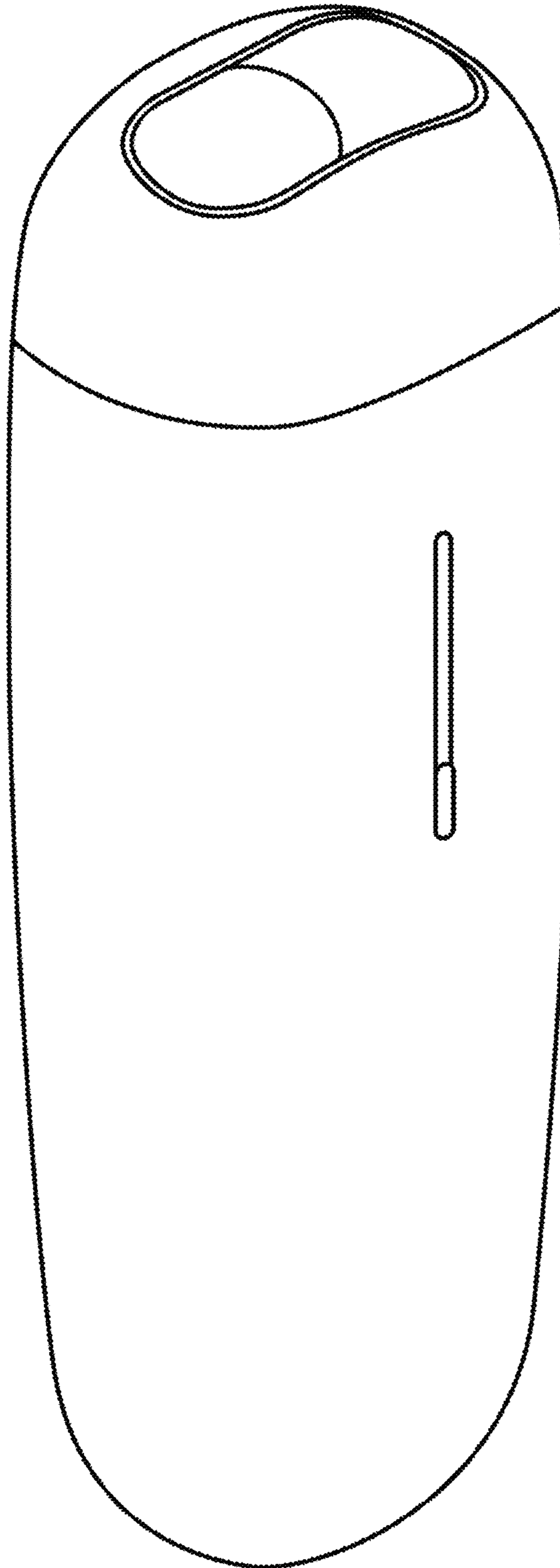

18.2

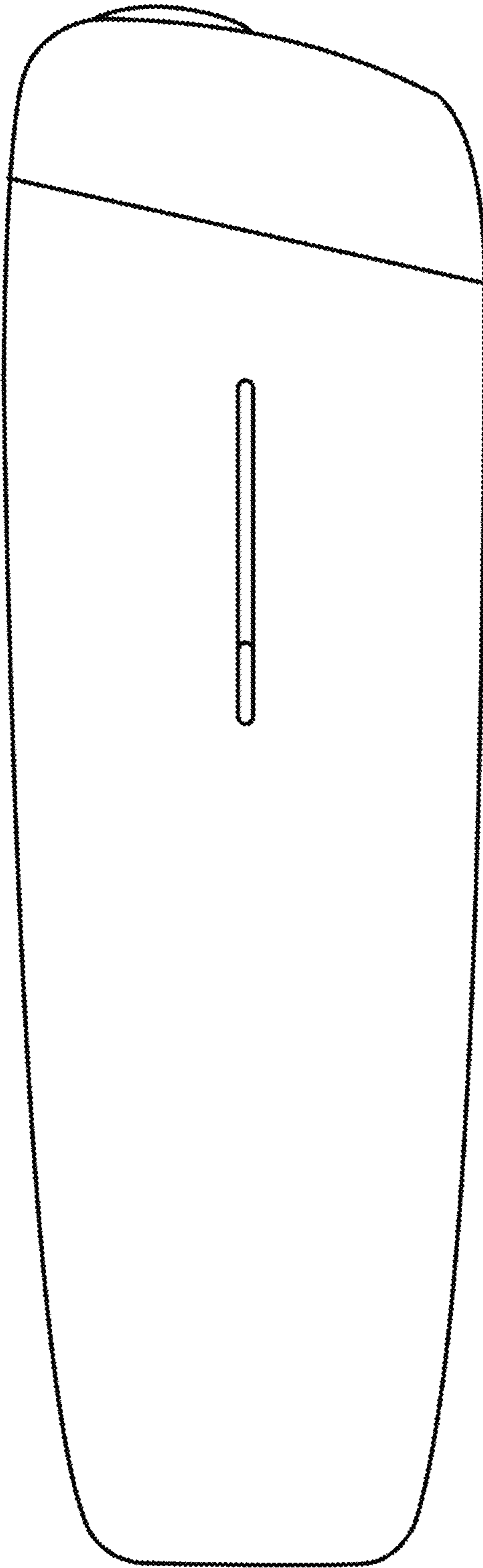

18.3

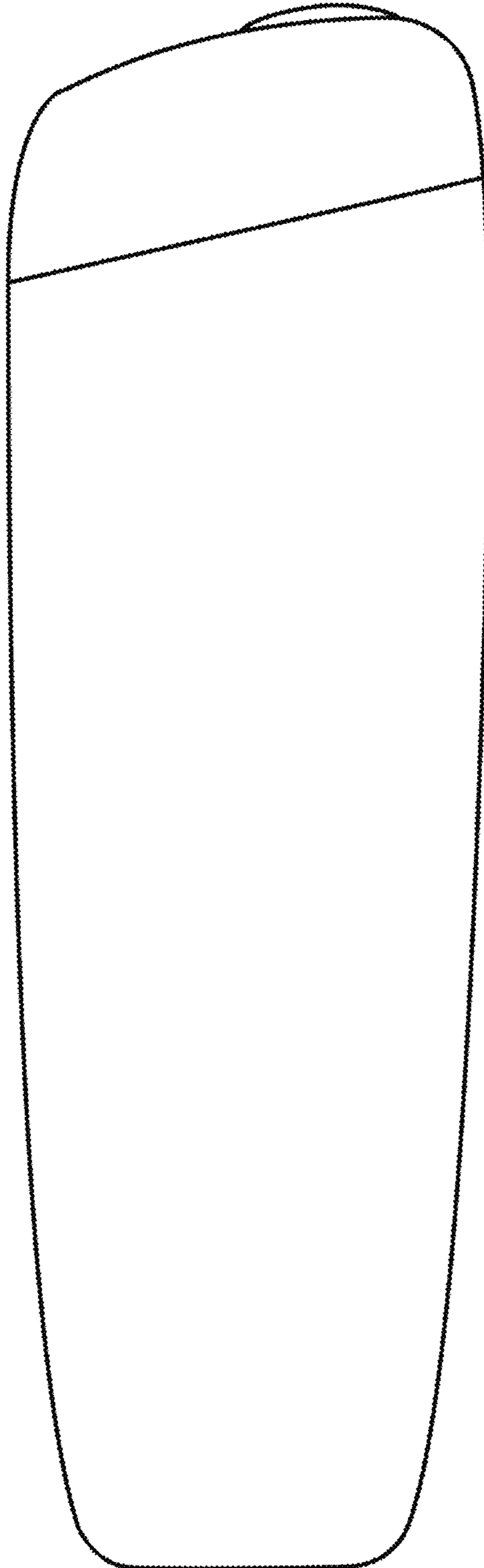

18.4

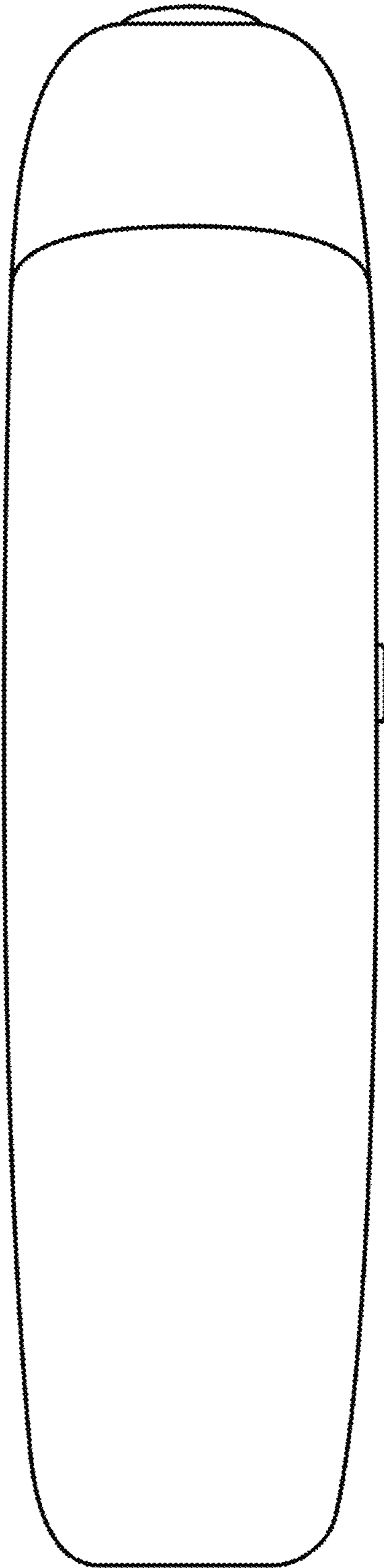

18.5

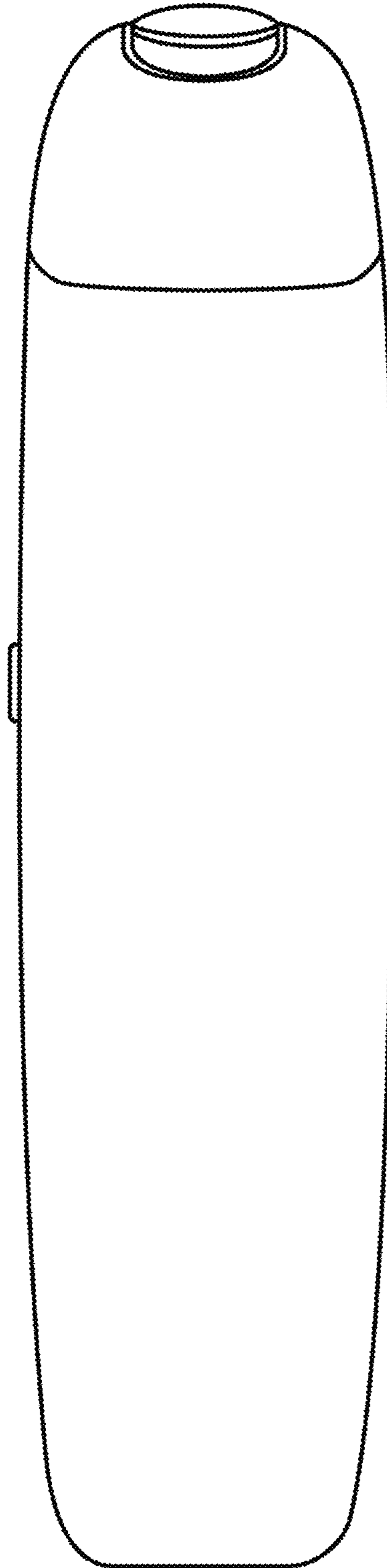

18.6

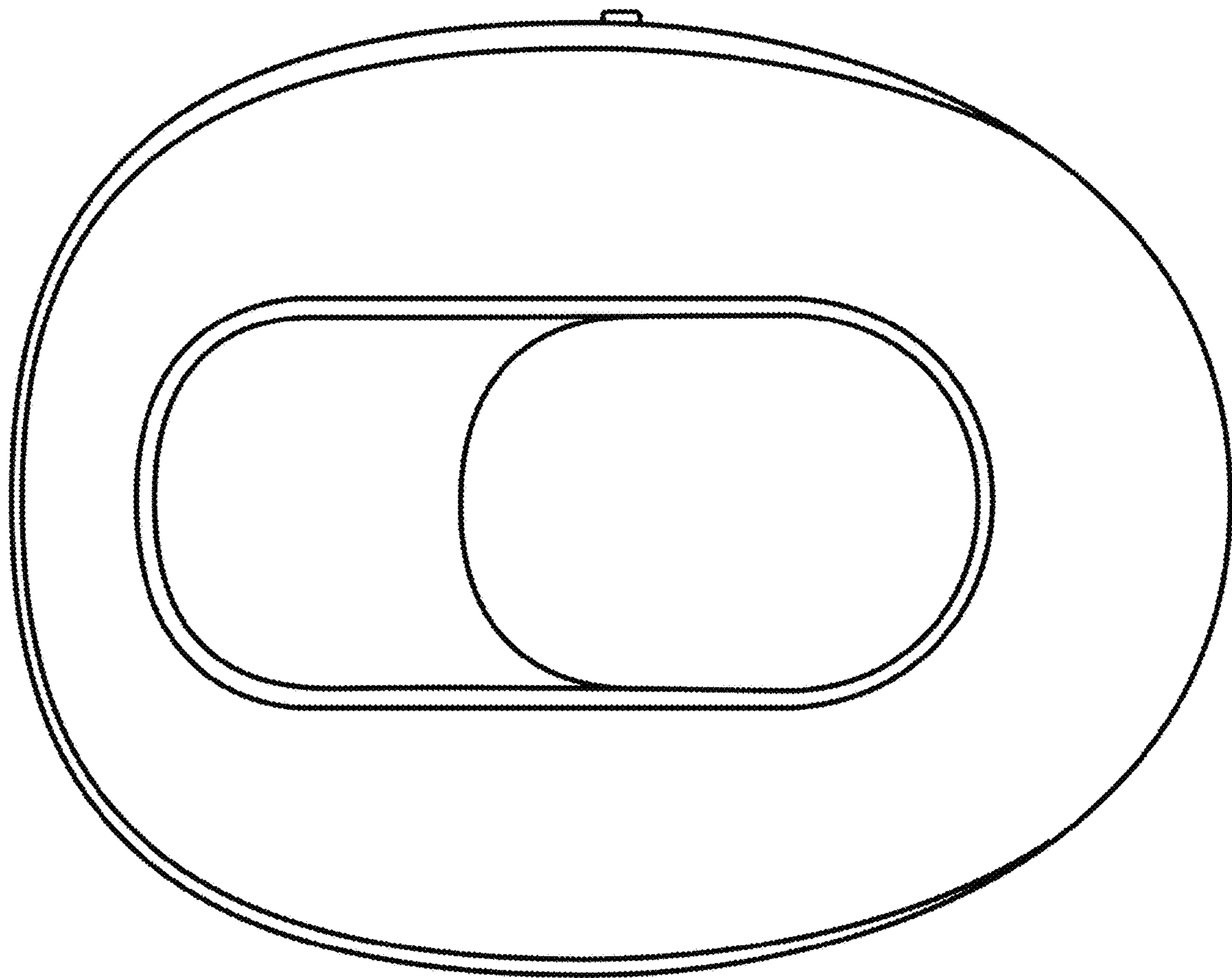

18.7

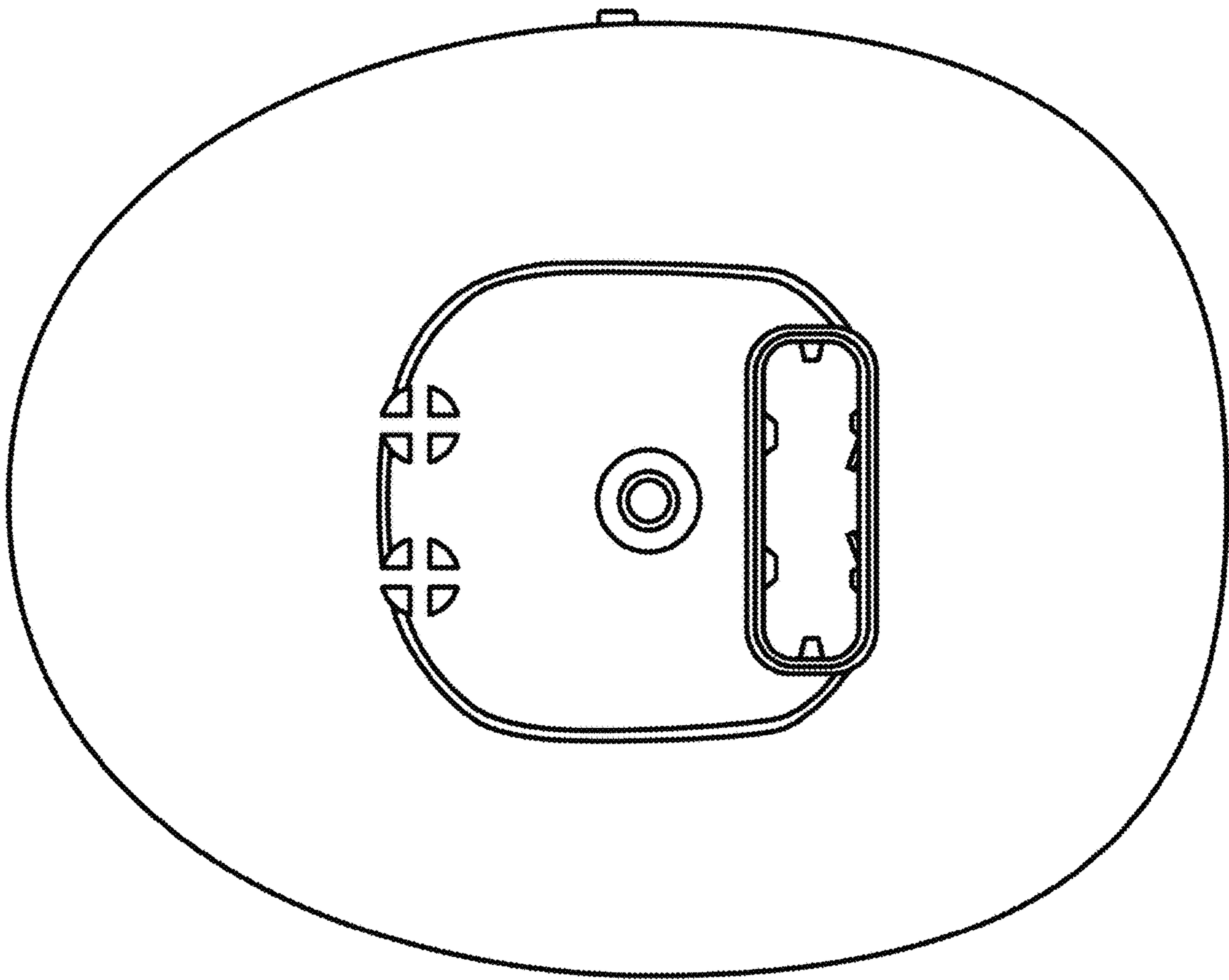

19.1

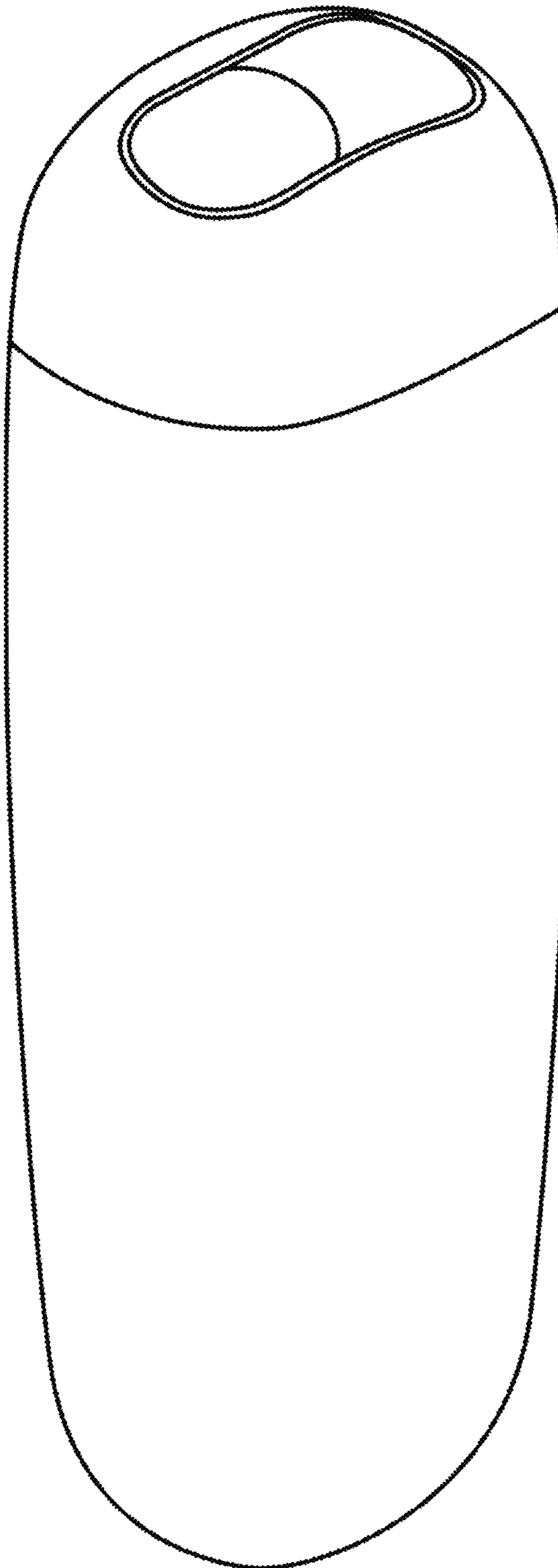

19.2

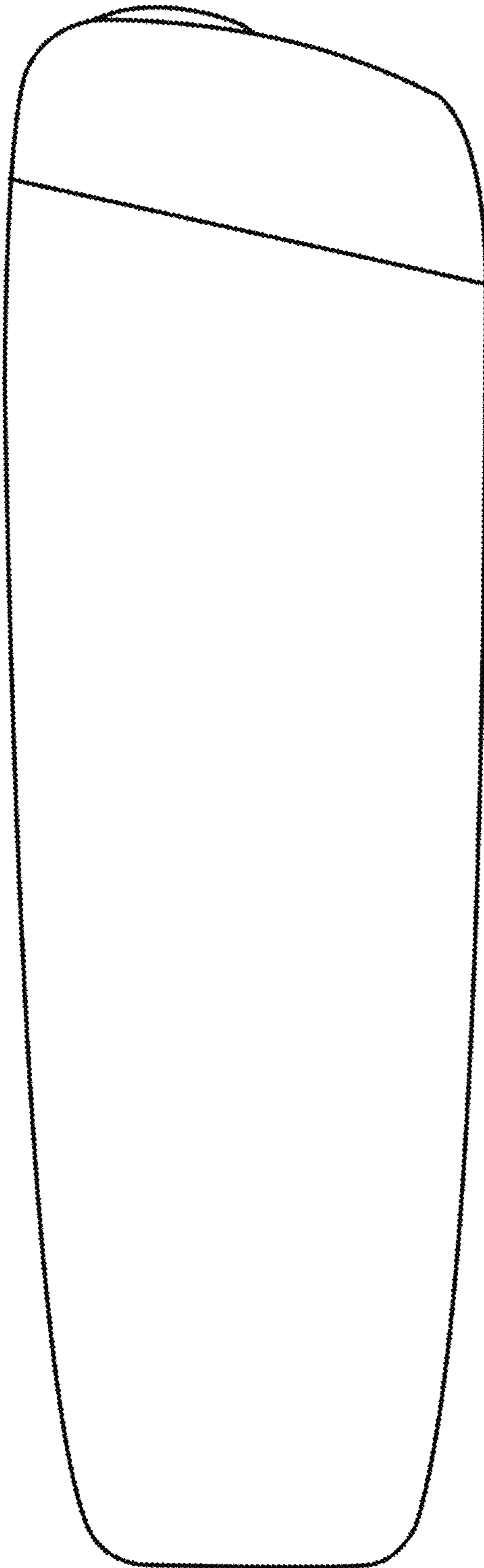

19.3

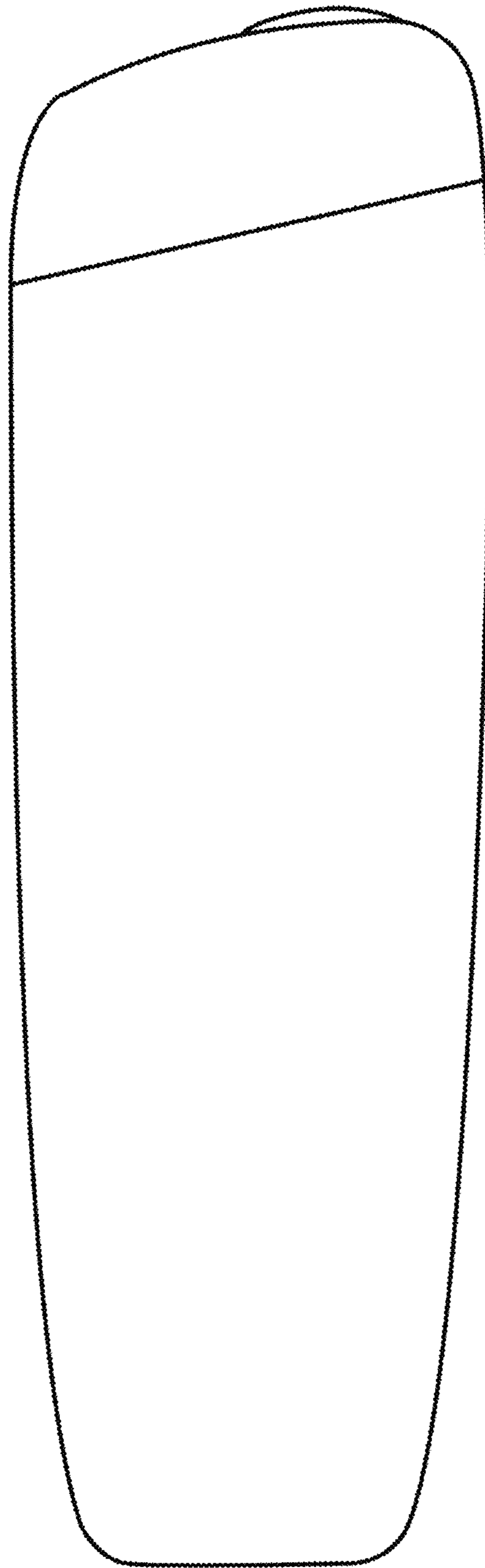

19.4

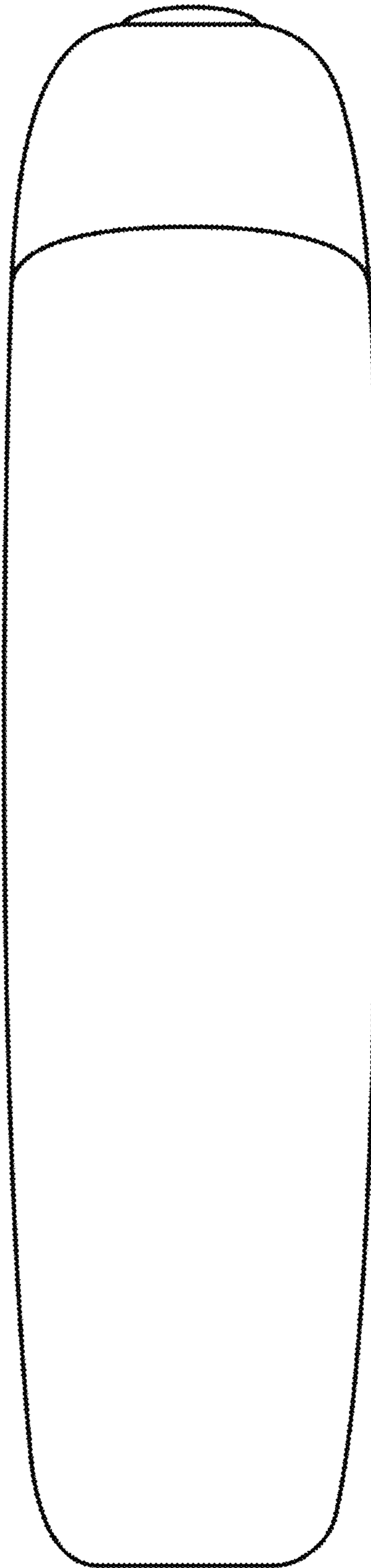

19.5

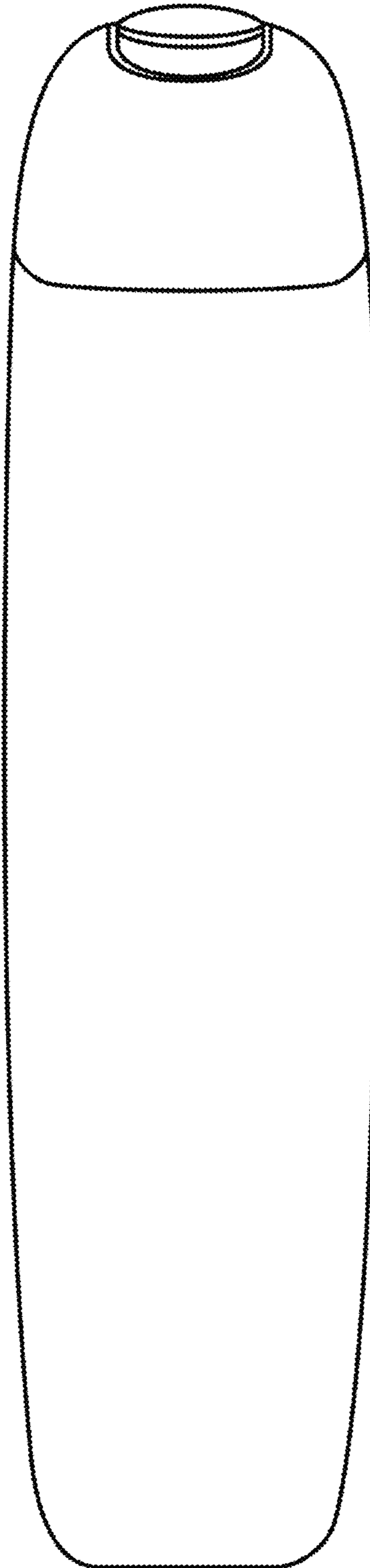

19.6

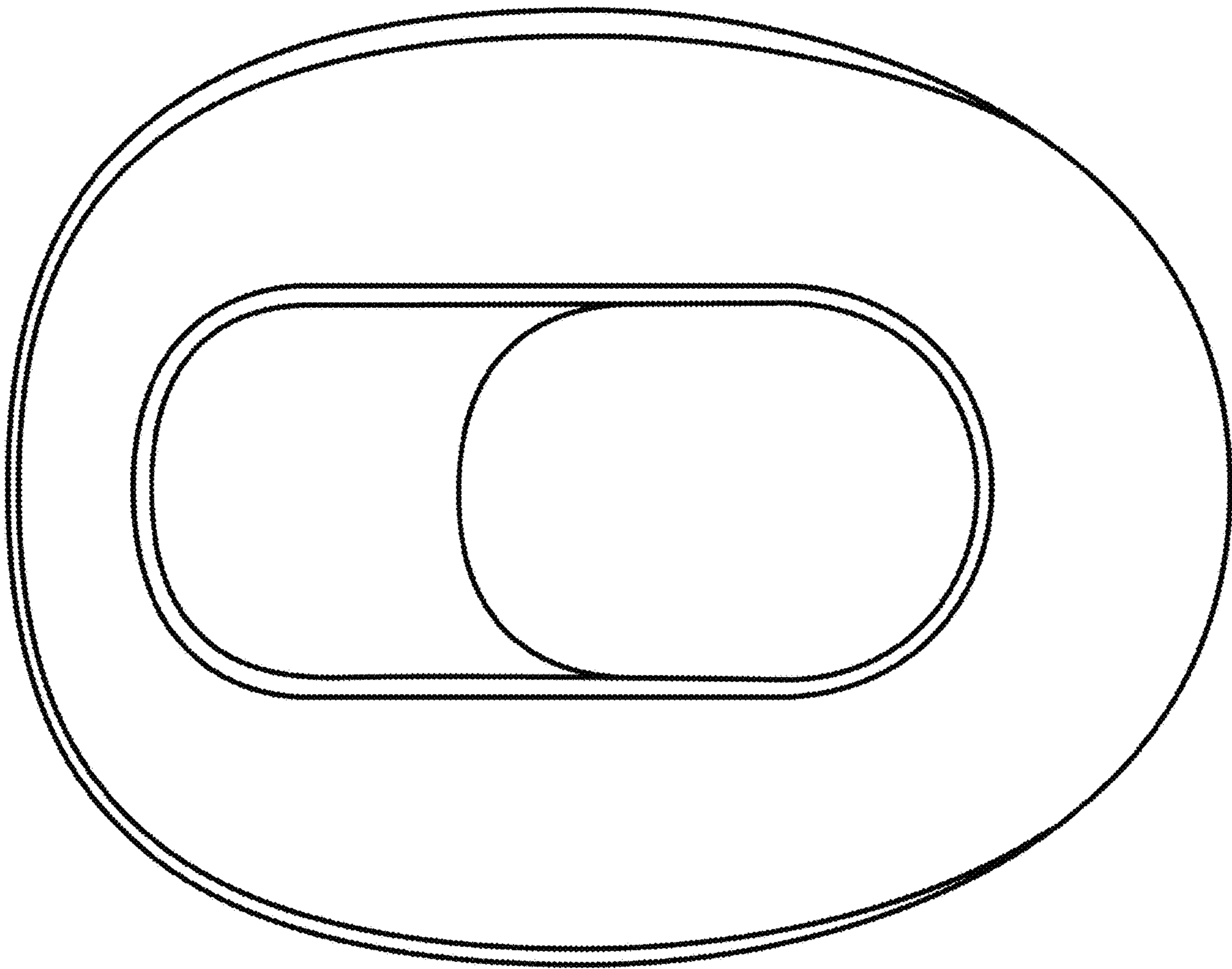

19.7

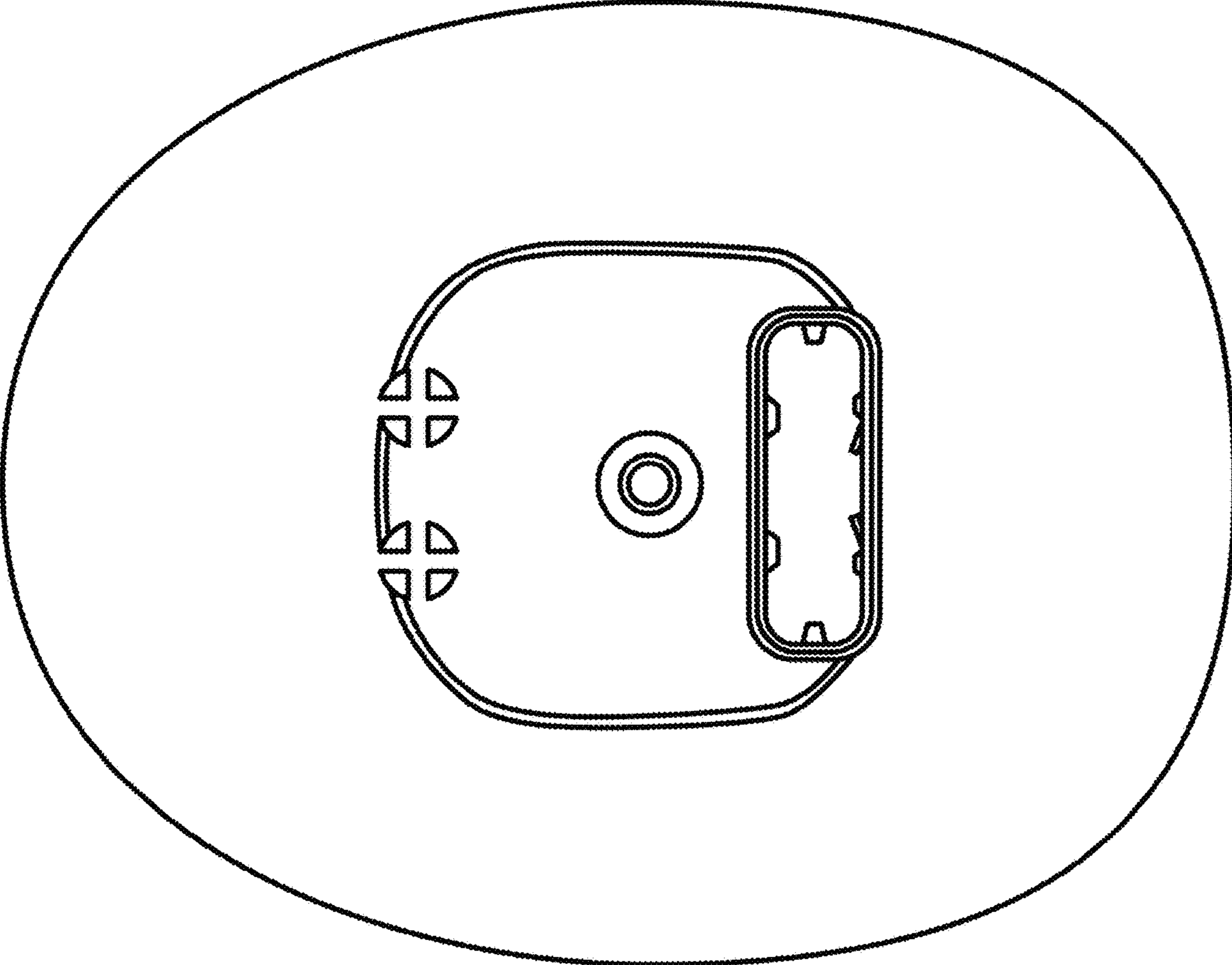

22.1

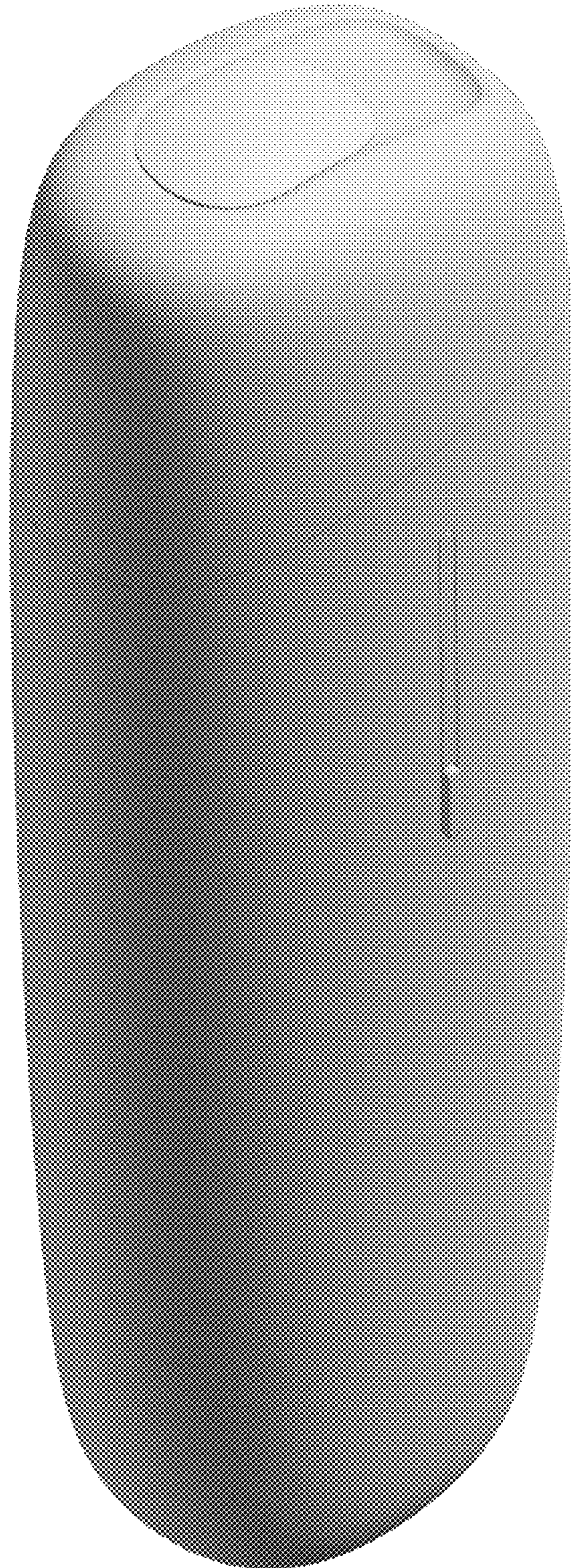

22.2

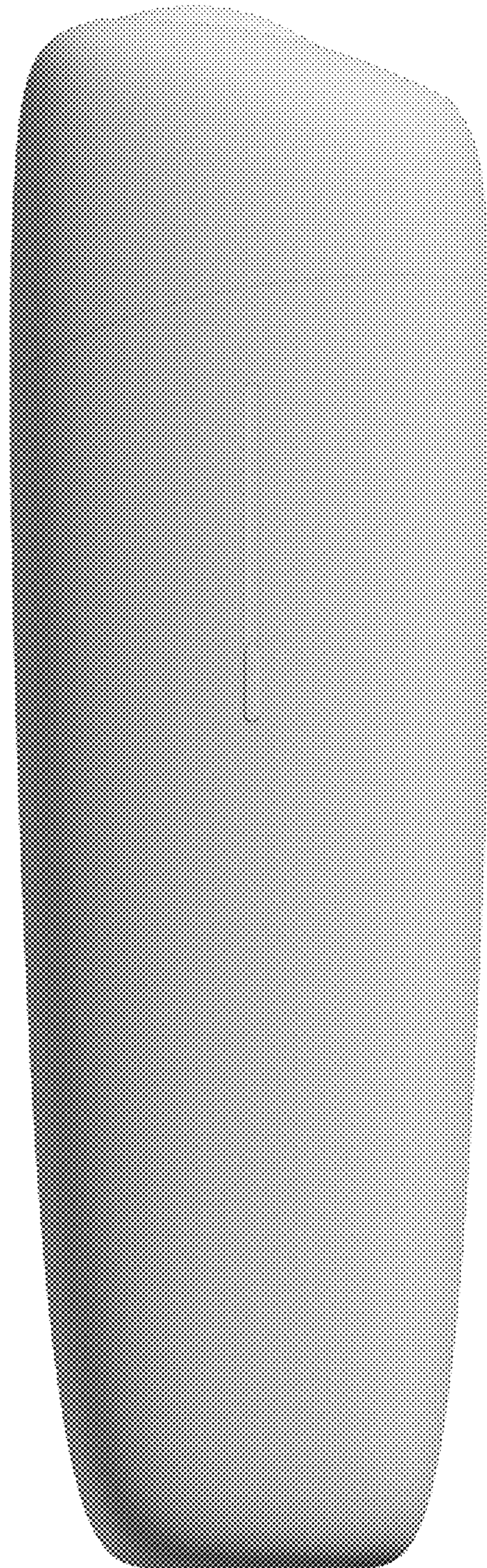

22.3

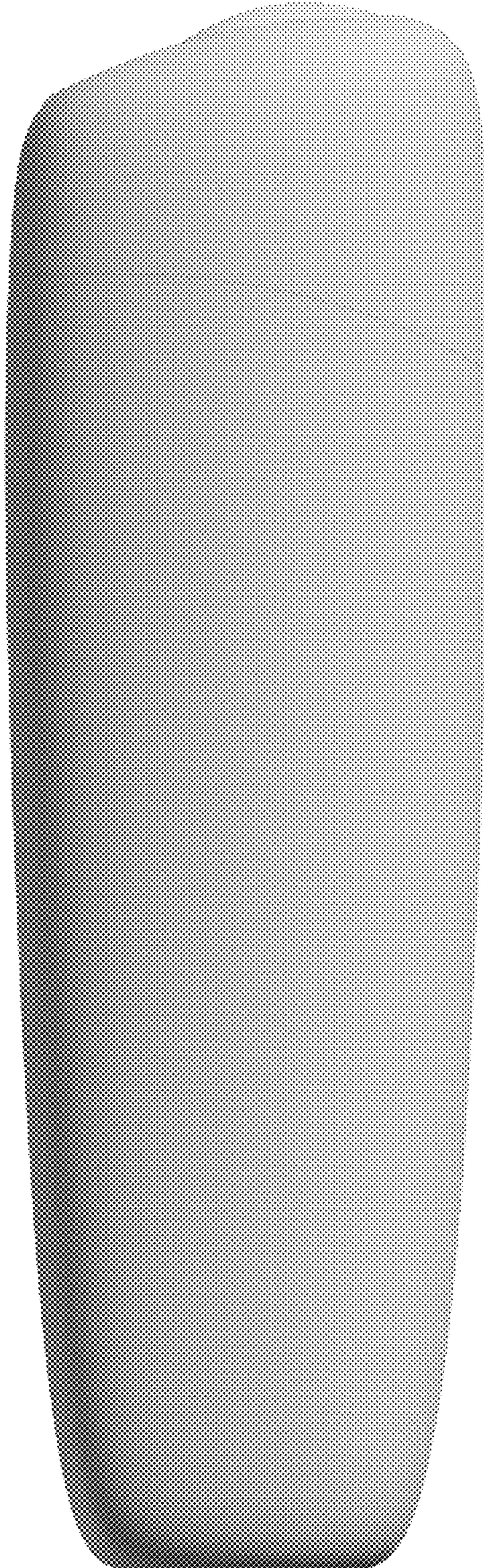

22.4

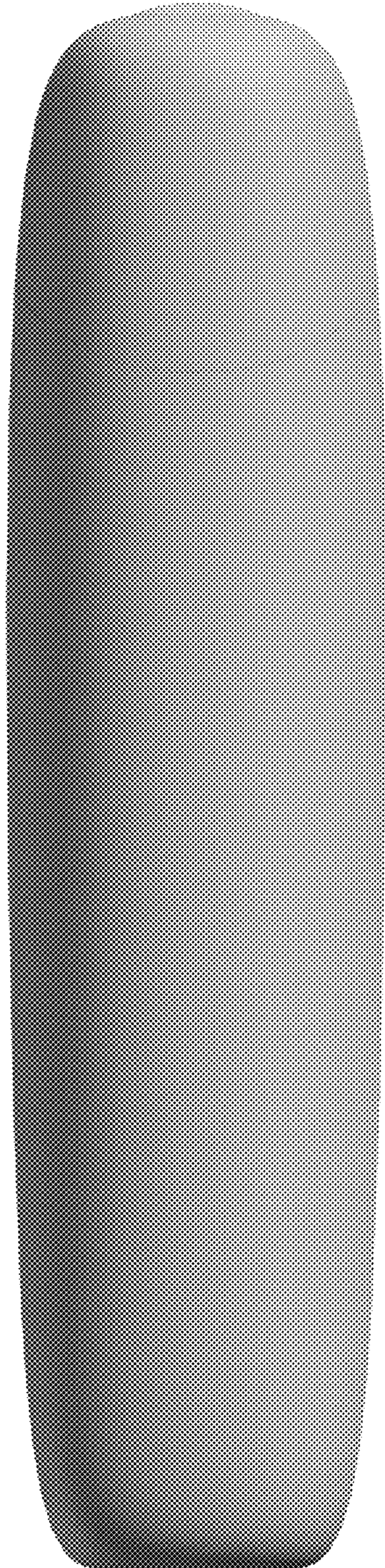

22.5

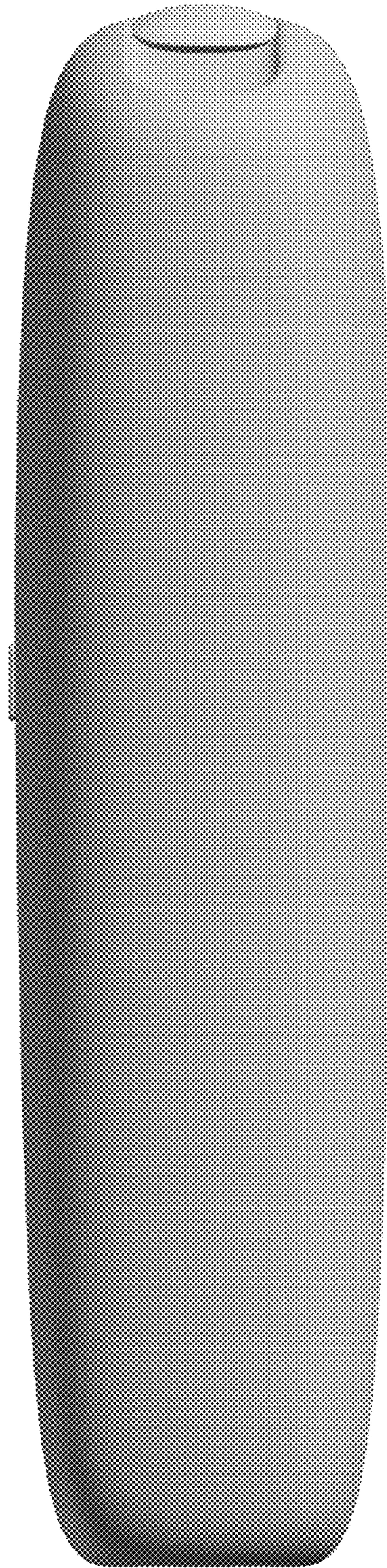

22.6



22.7

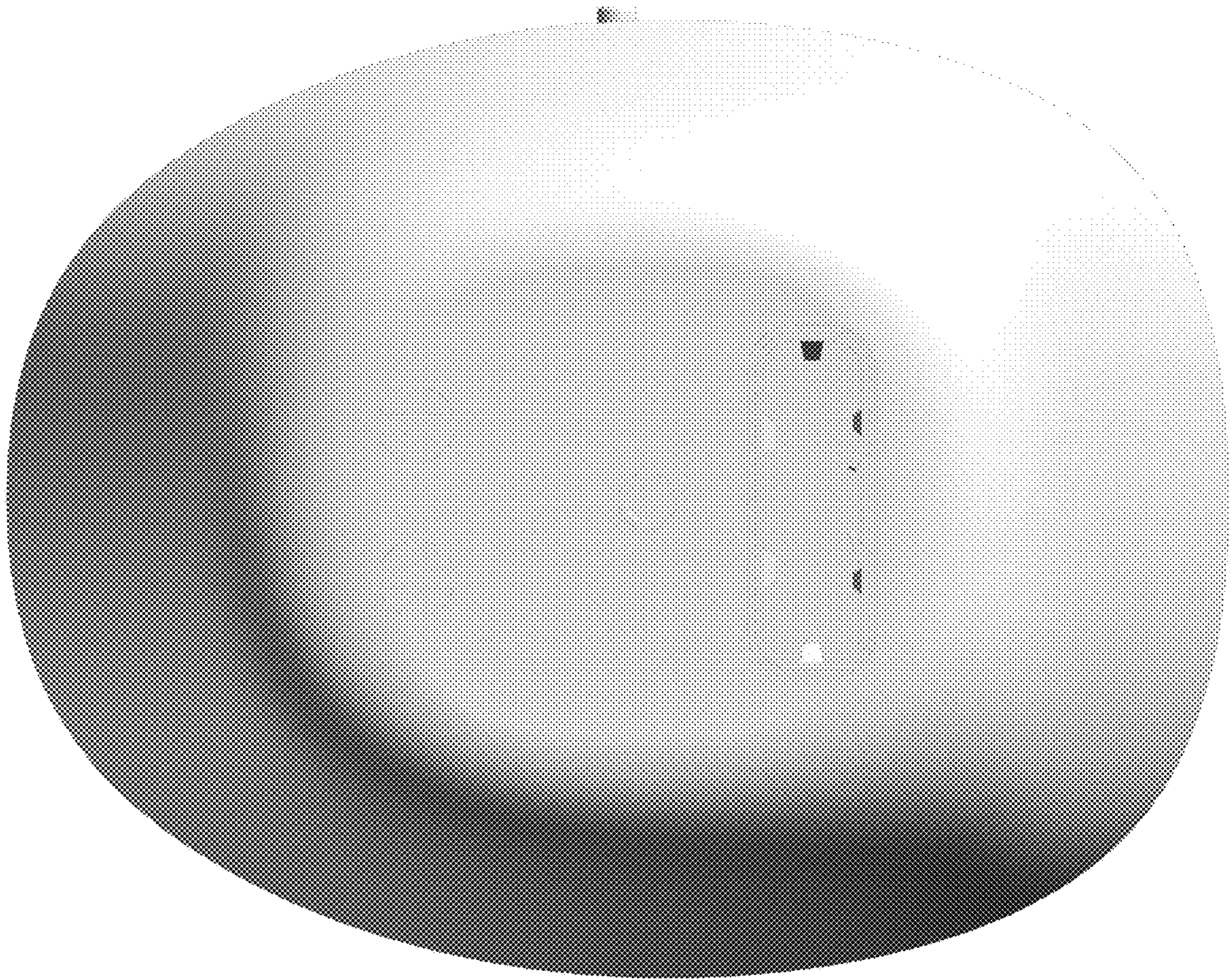

23.1

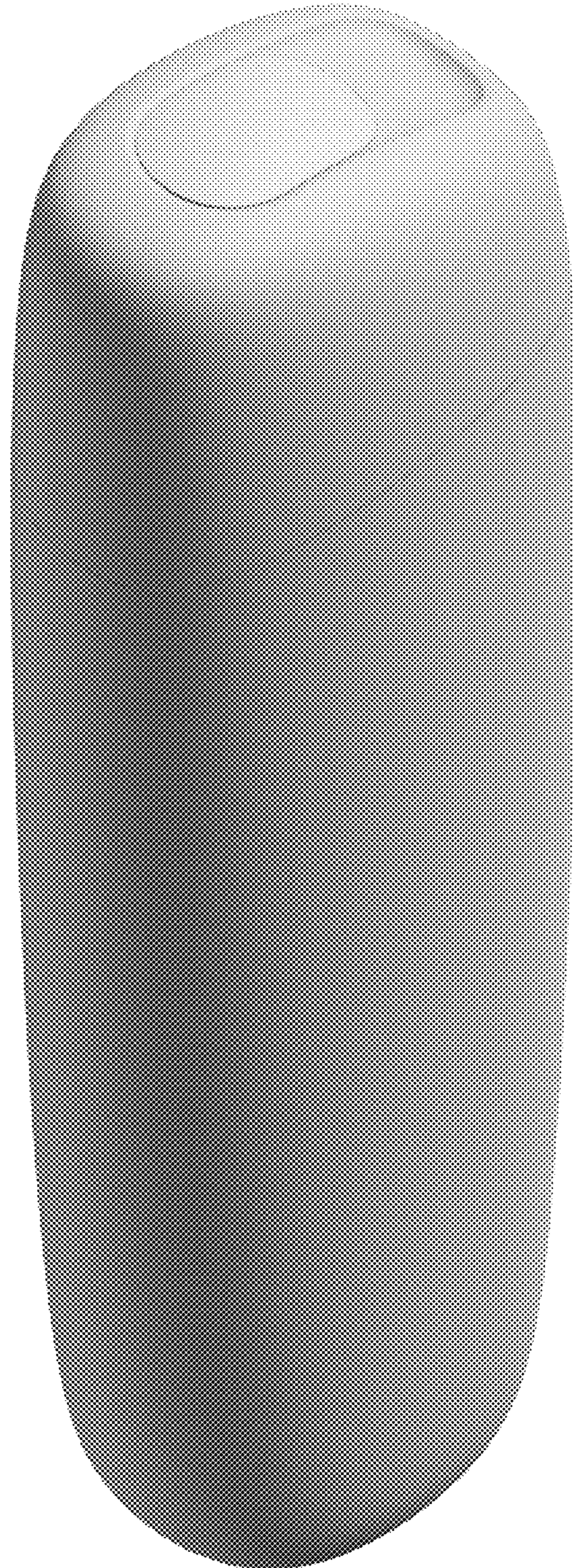

23.2

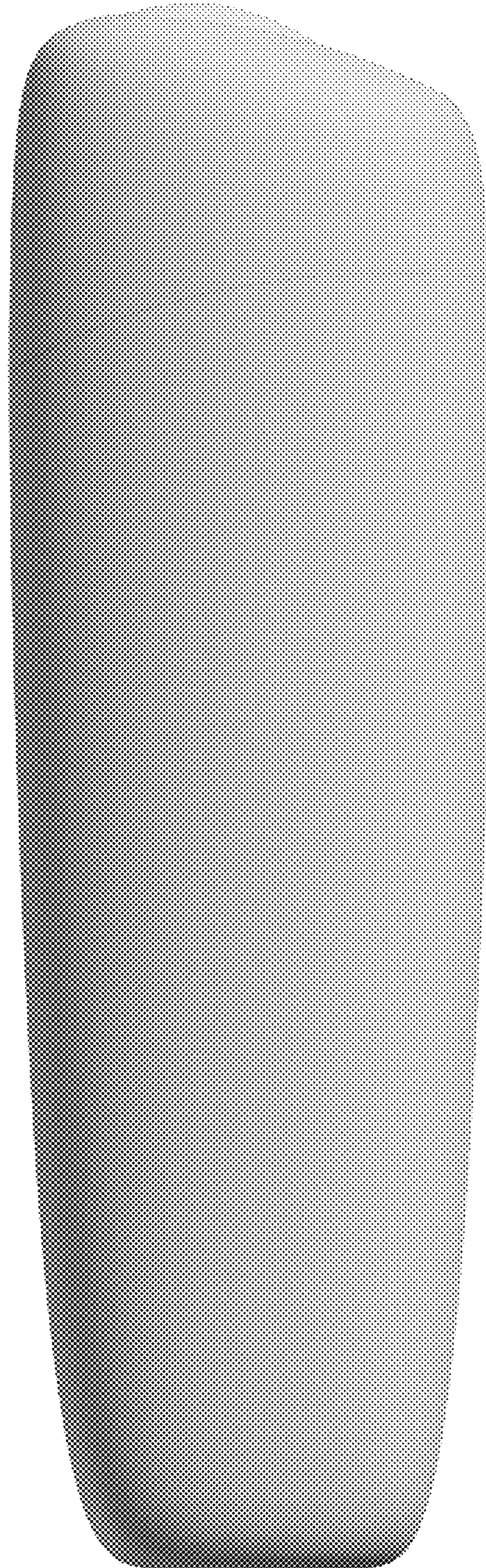

23.3

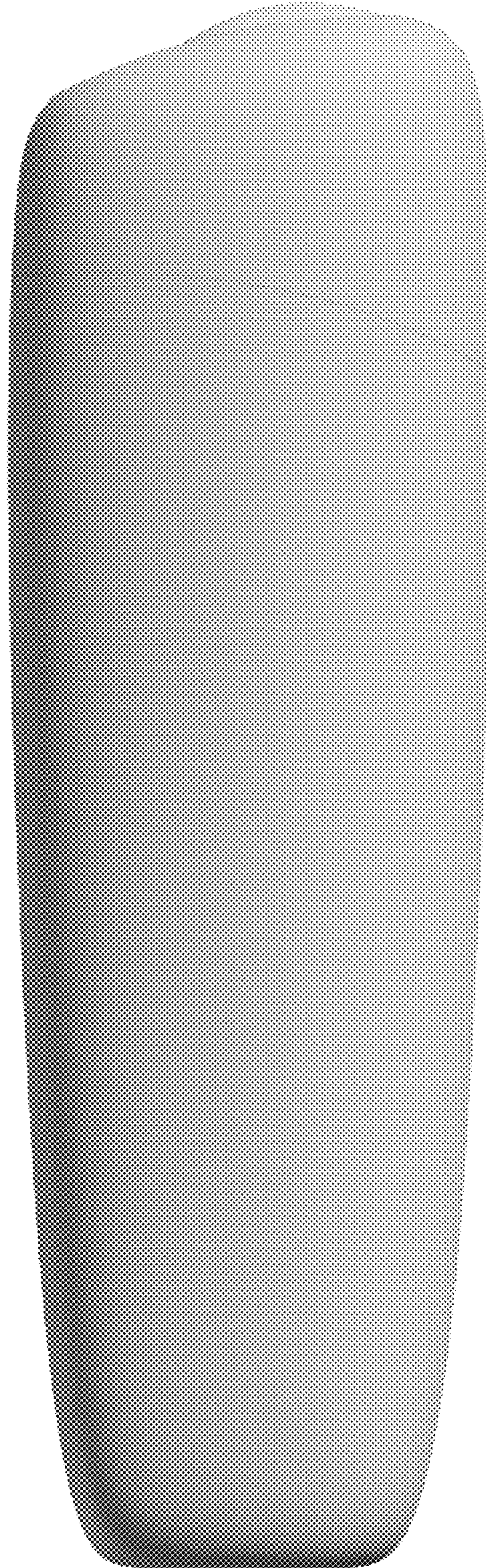

23.4

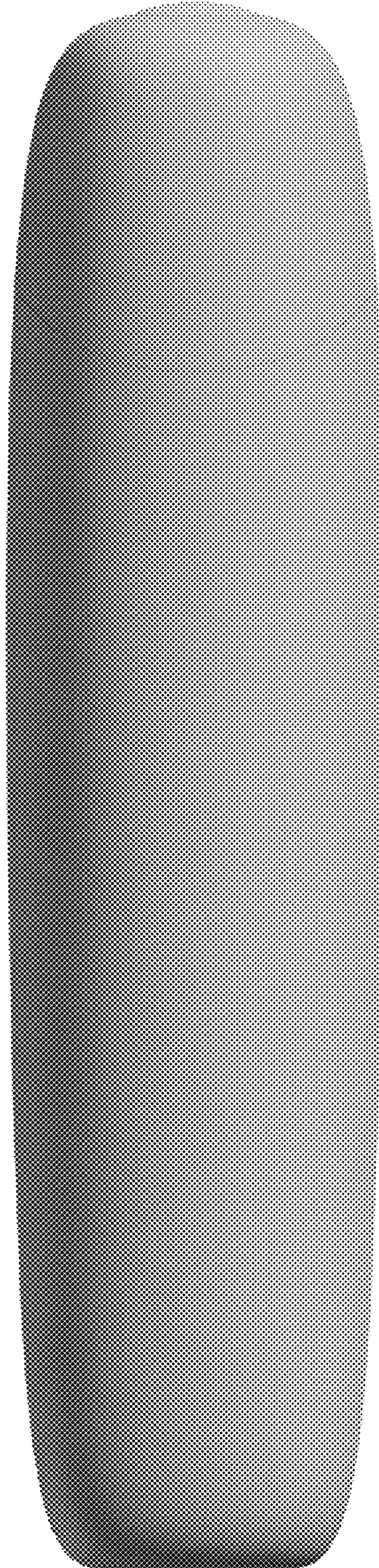

23.5

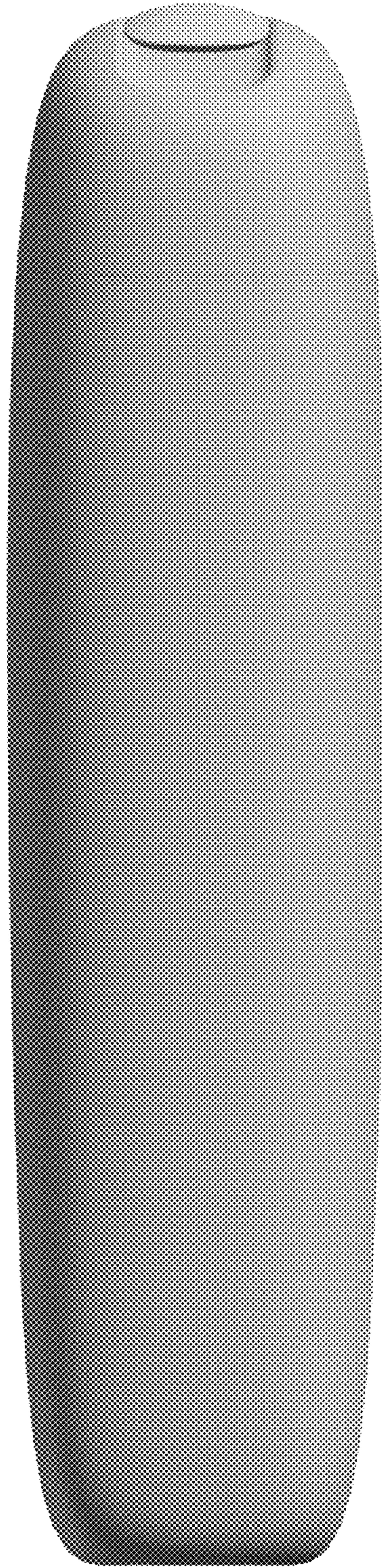

23.6



23.7

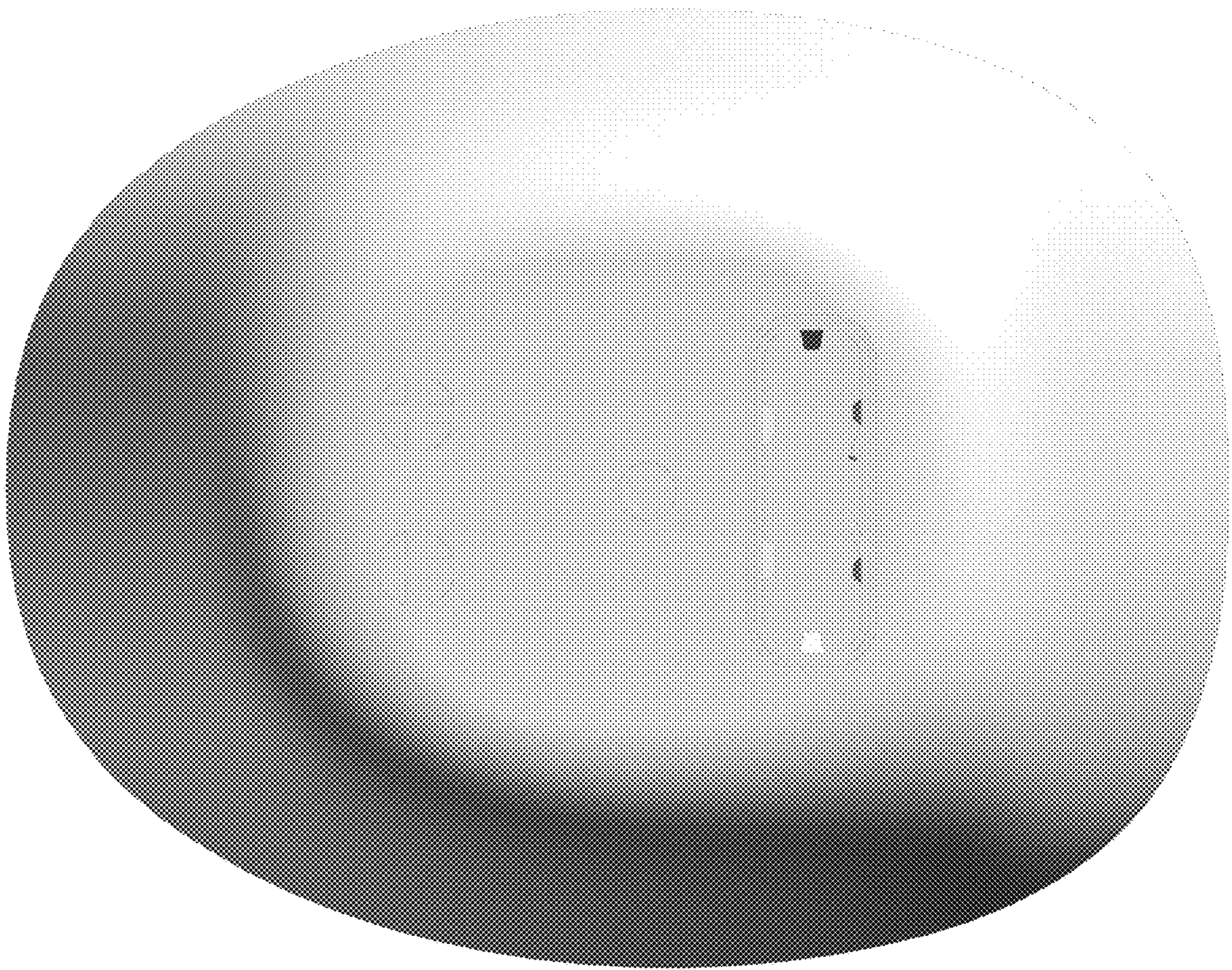

26.1

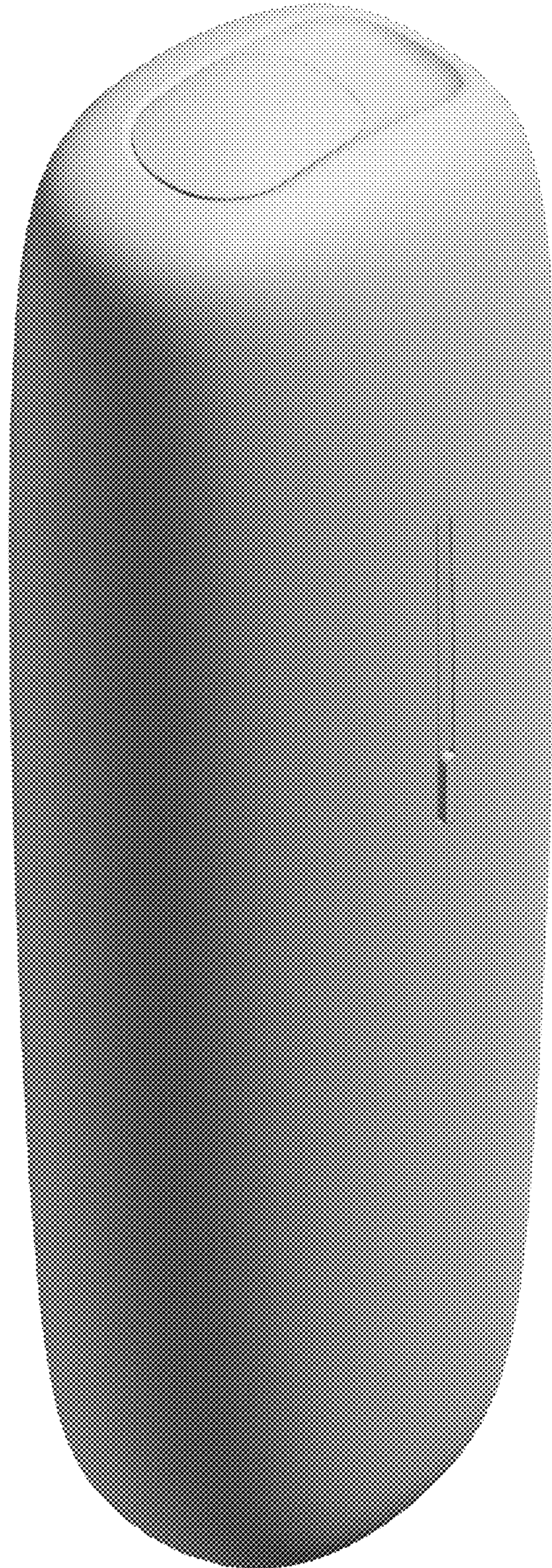

26.2



26.3

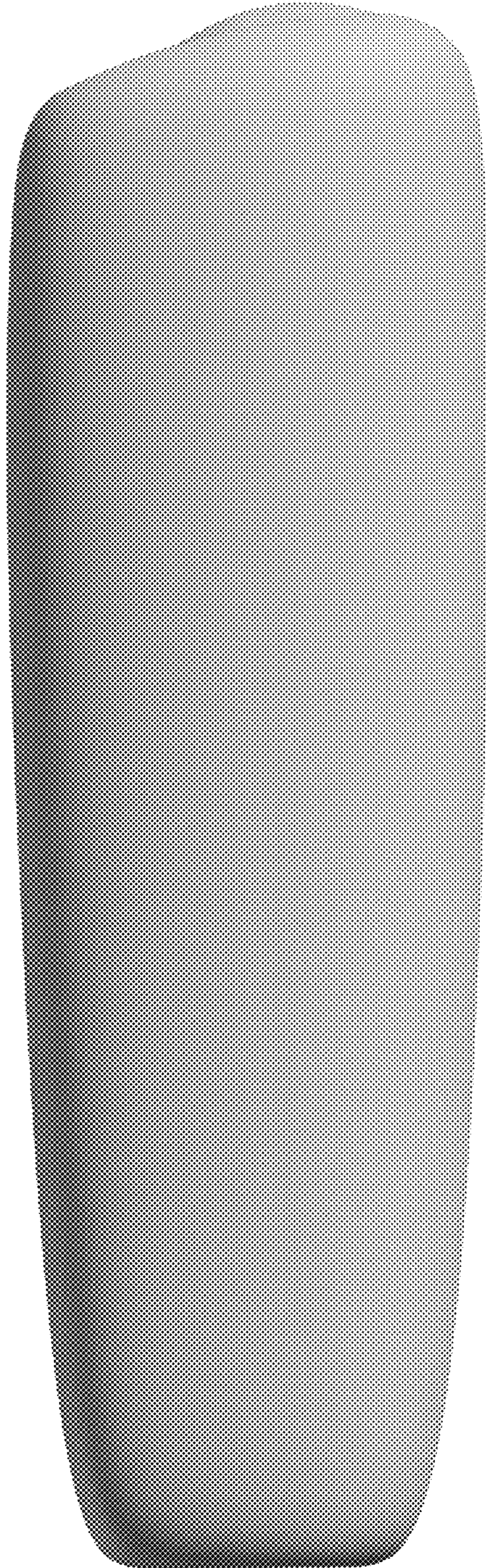

26.4

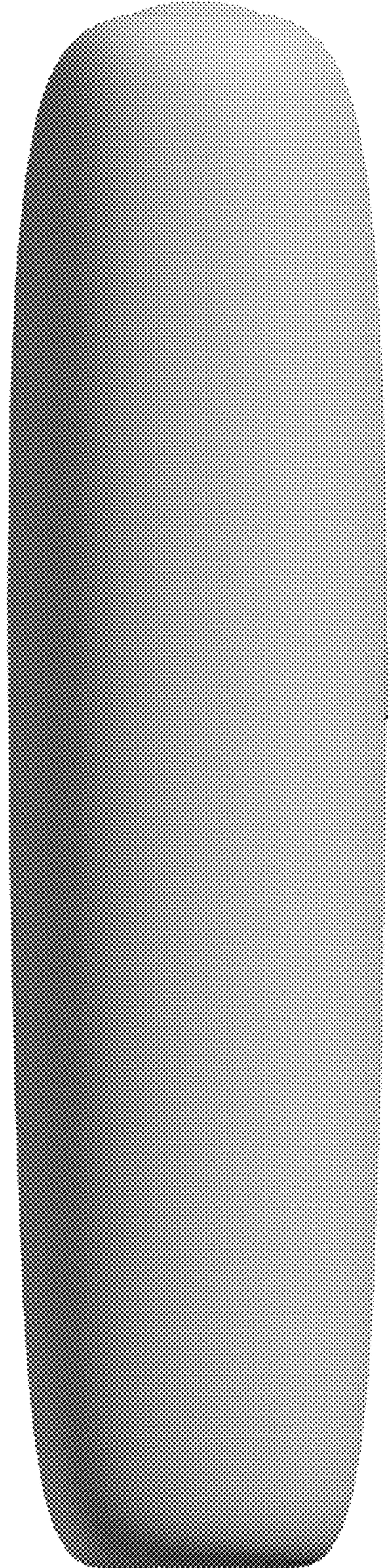

26.5

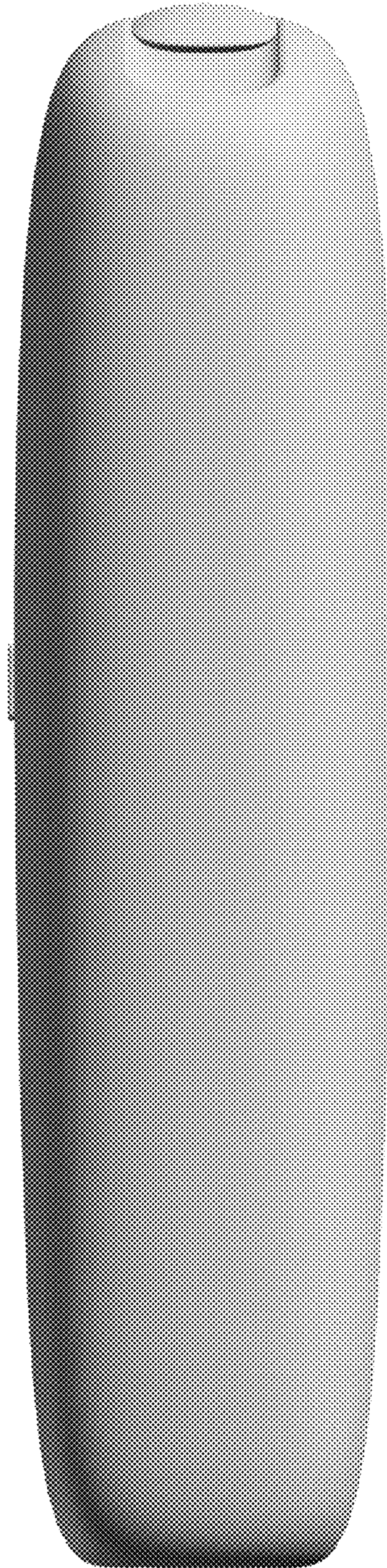

26.6



26.7



27.1

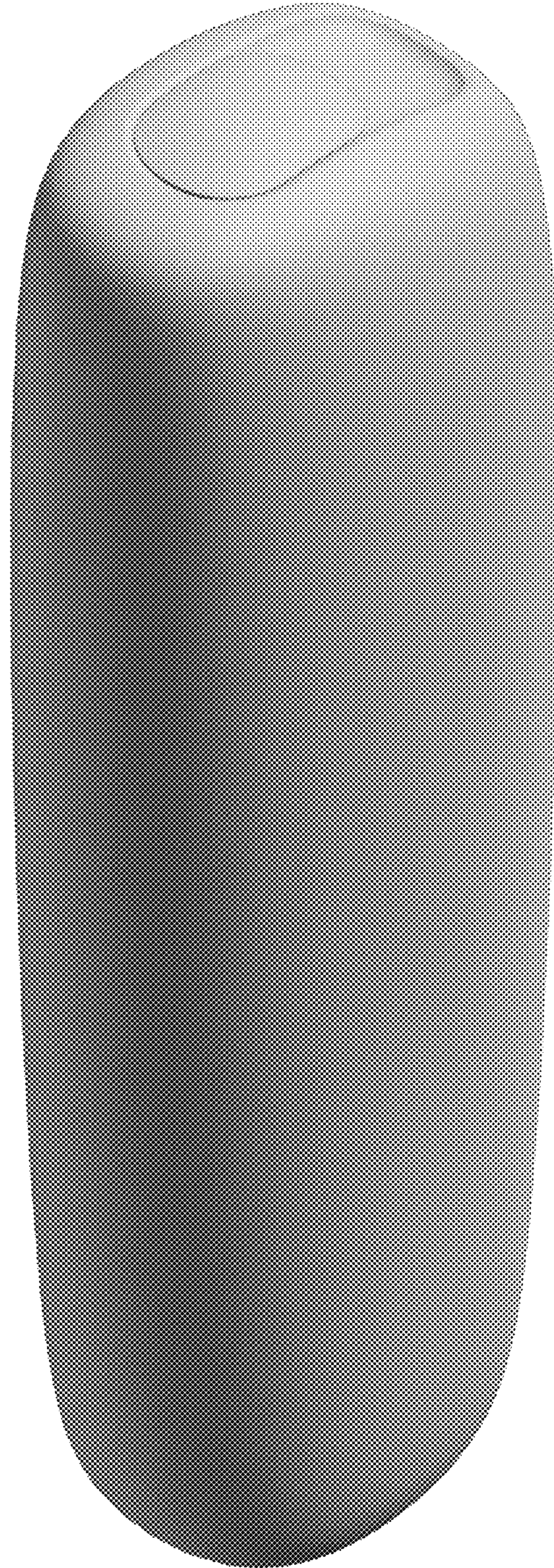

27.2

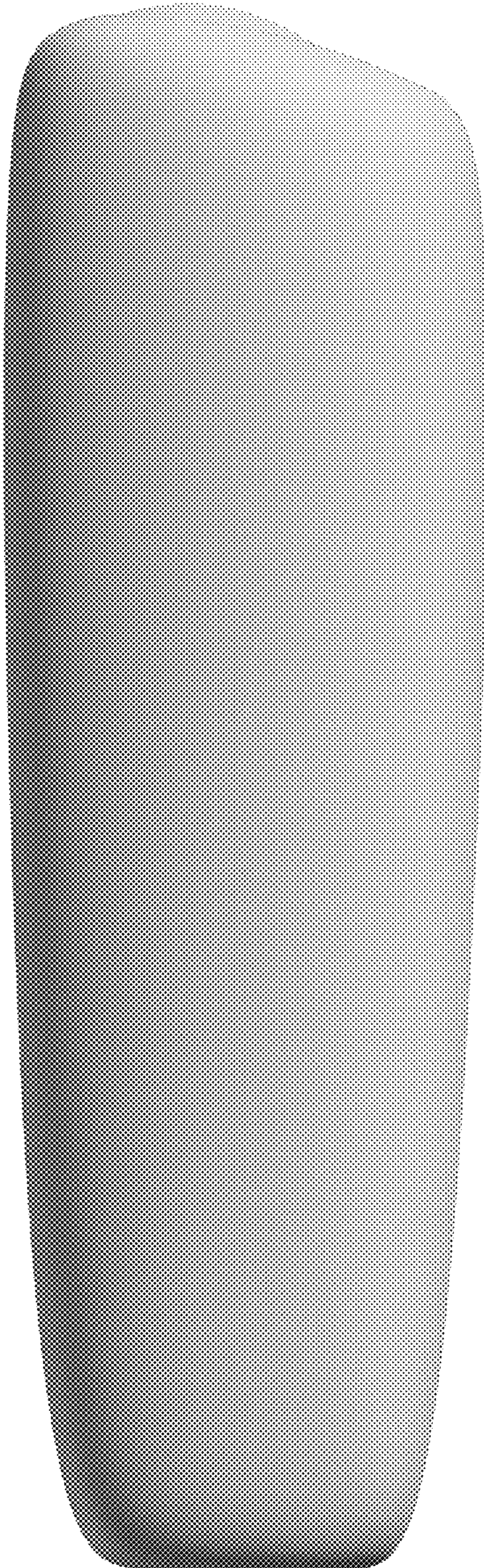

27.3

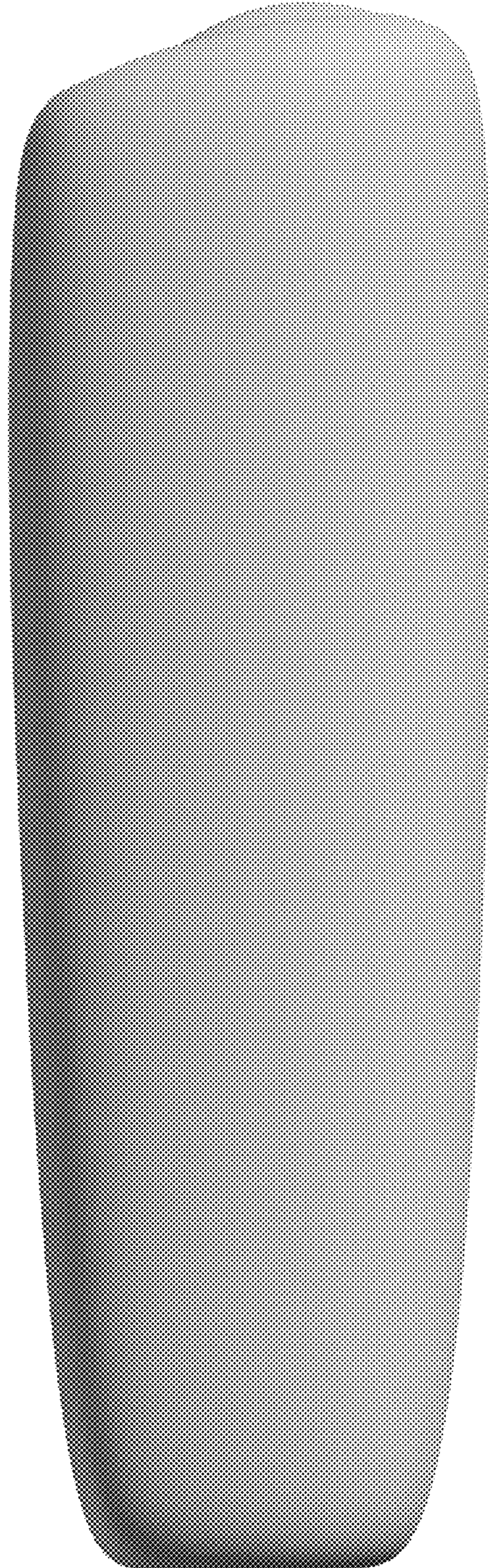

27.4

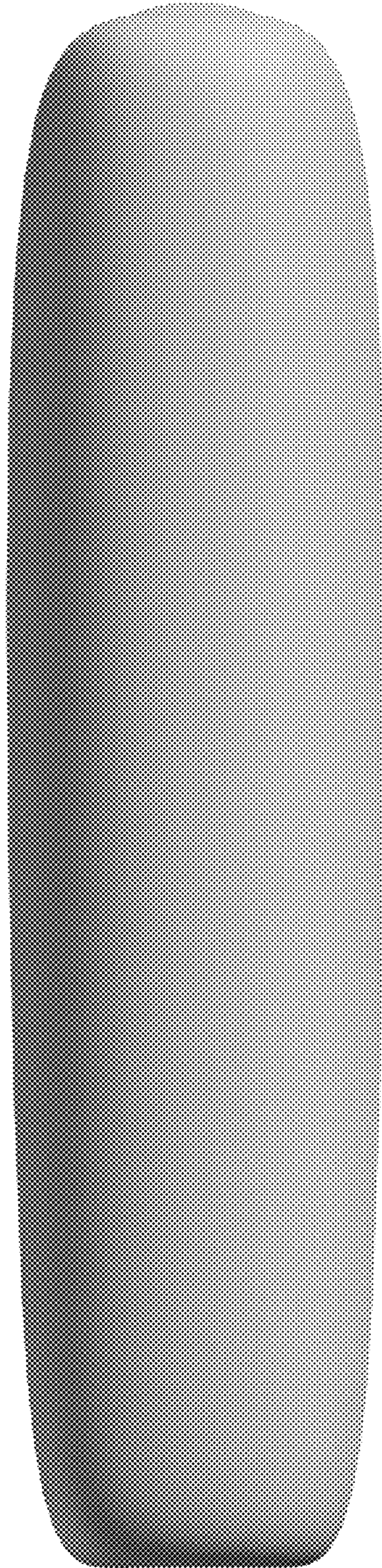

27.5

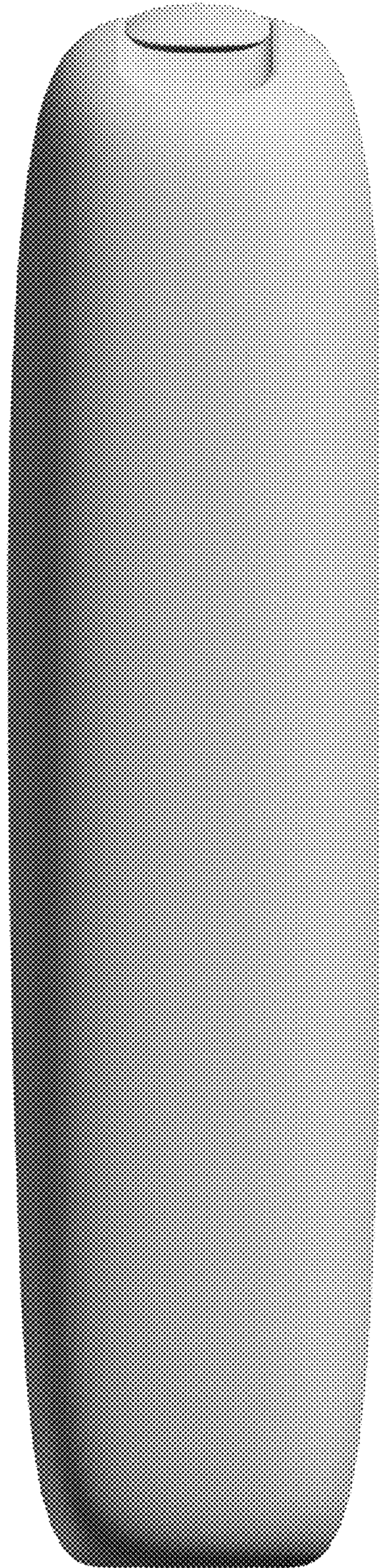

27.6



27.7

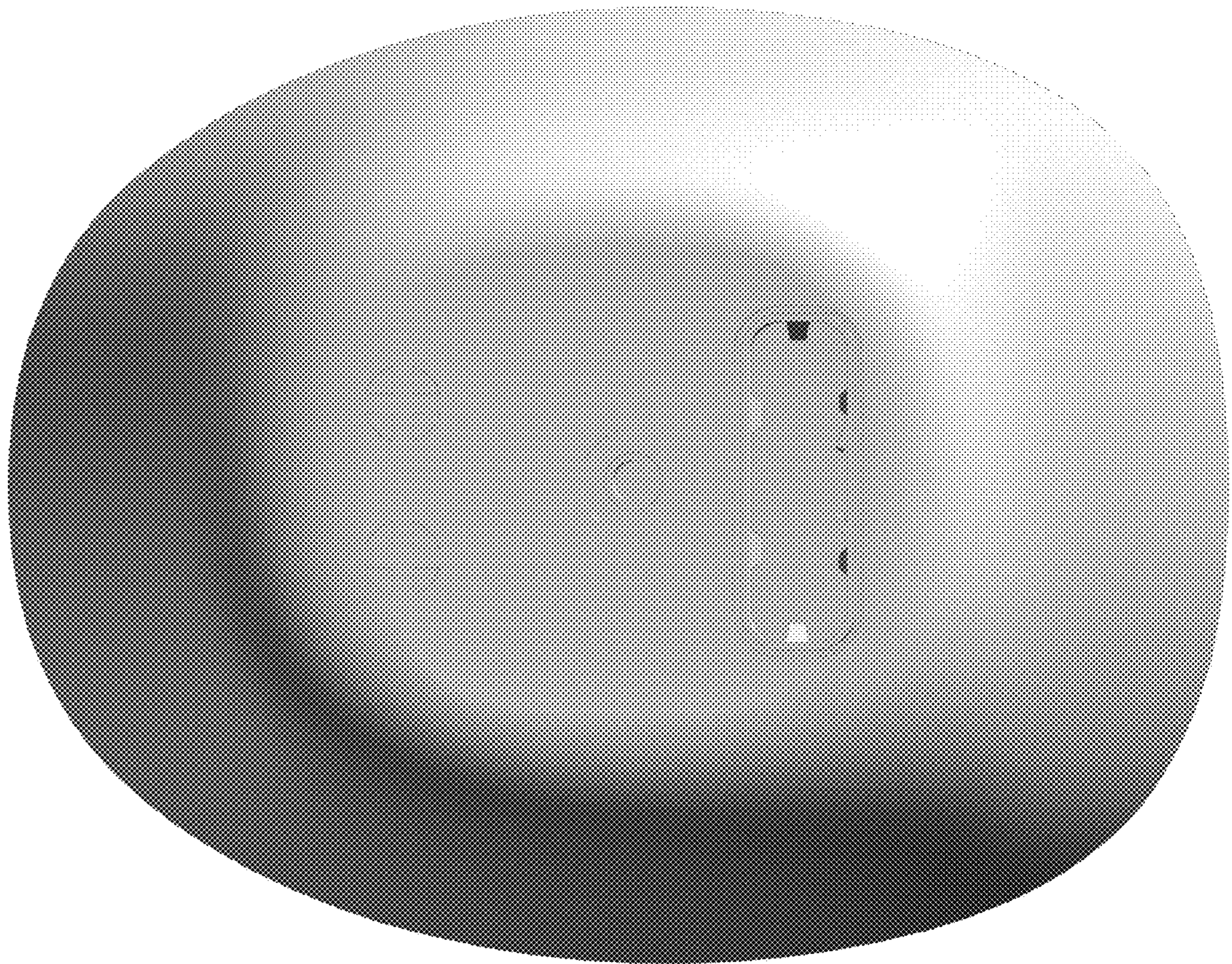

30.1

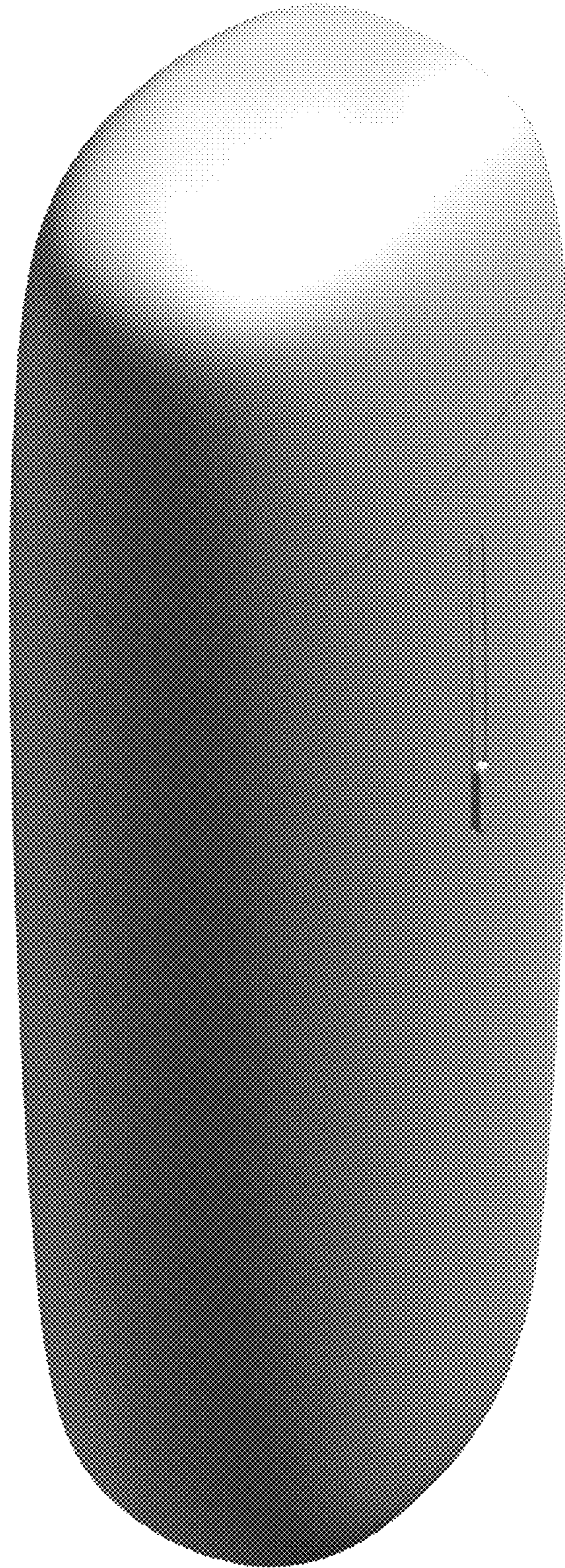

30.2



30.3

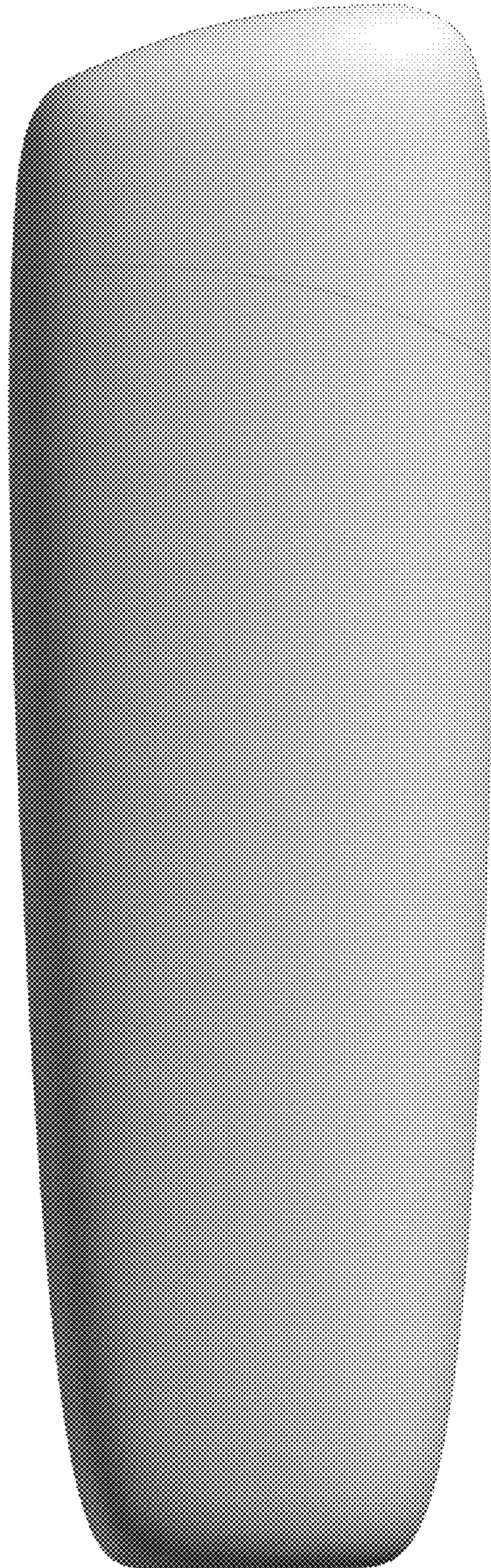

30.4

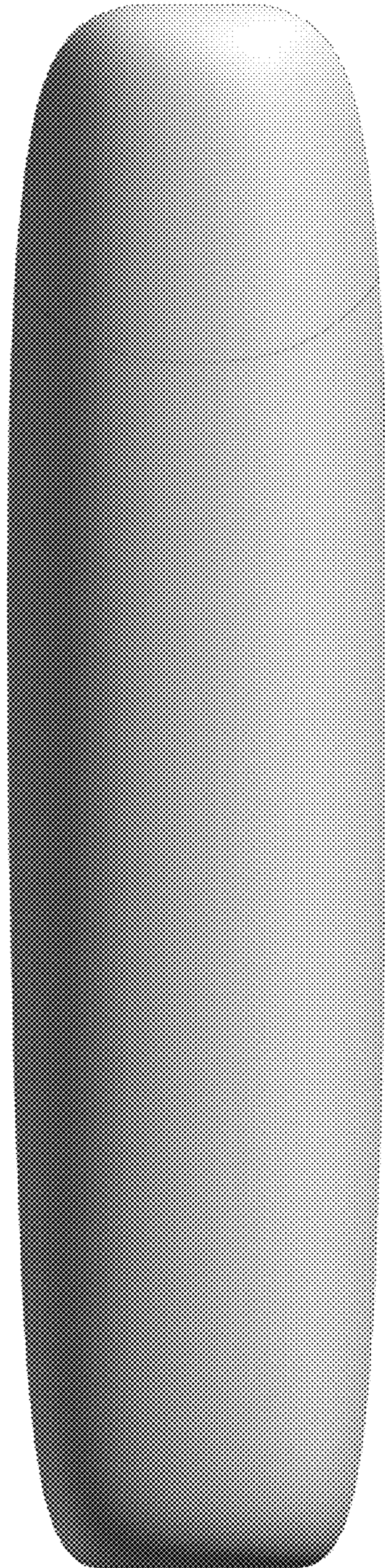

30.5

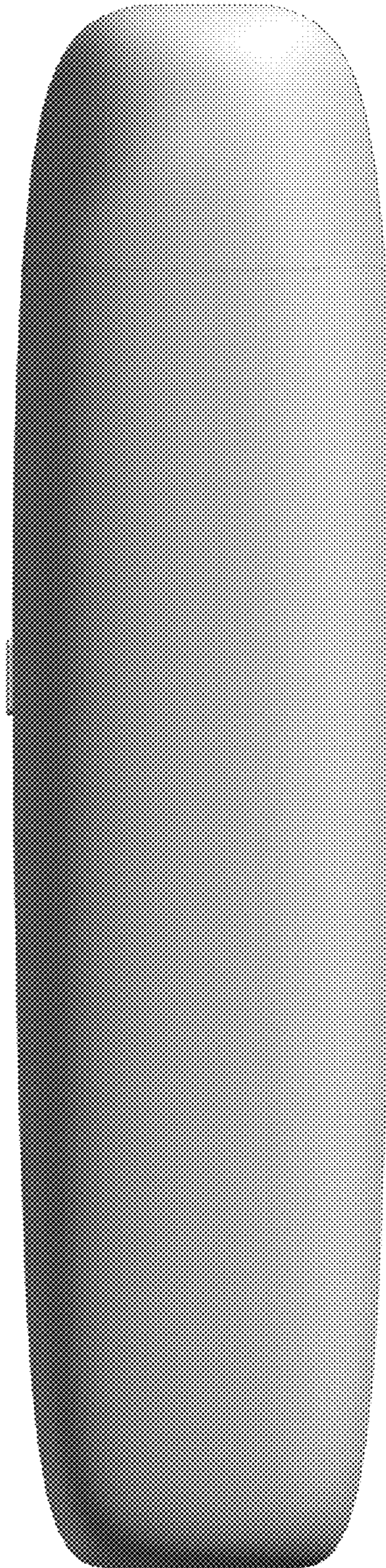

30.6



30.7



31.1

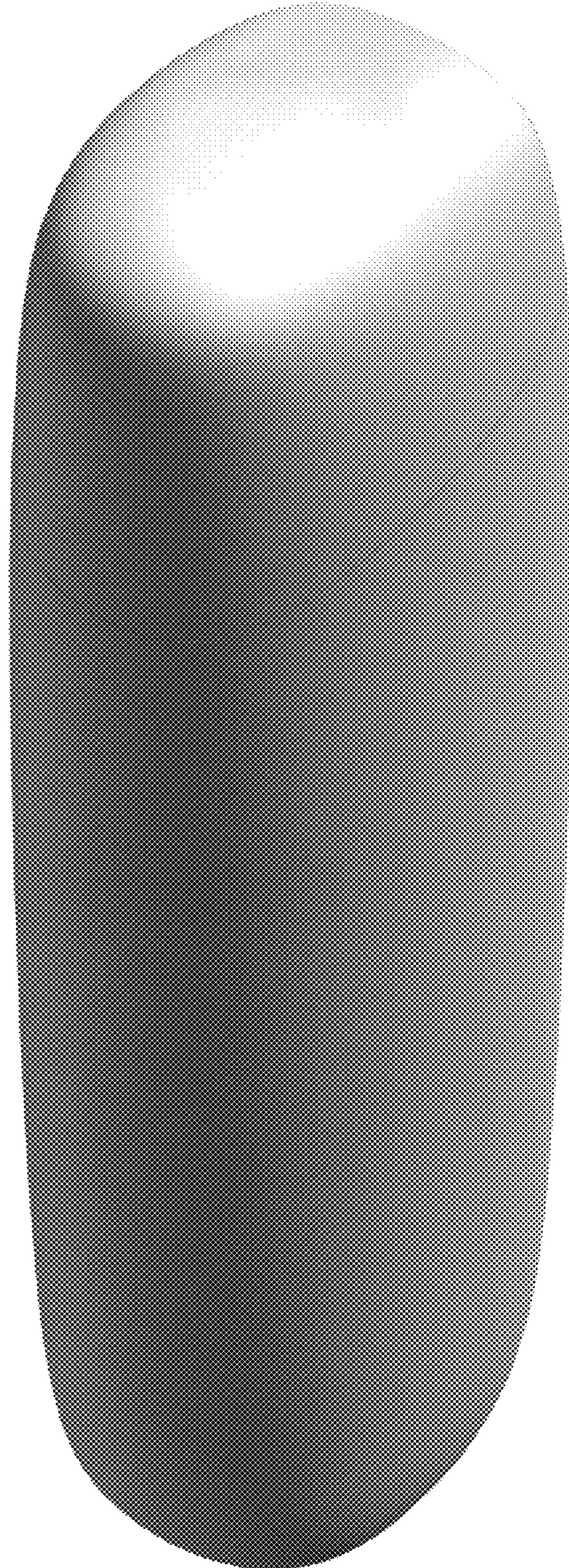

31.2

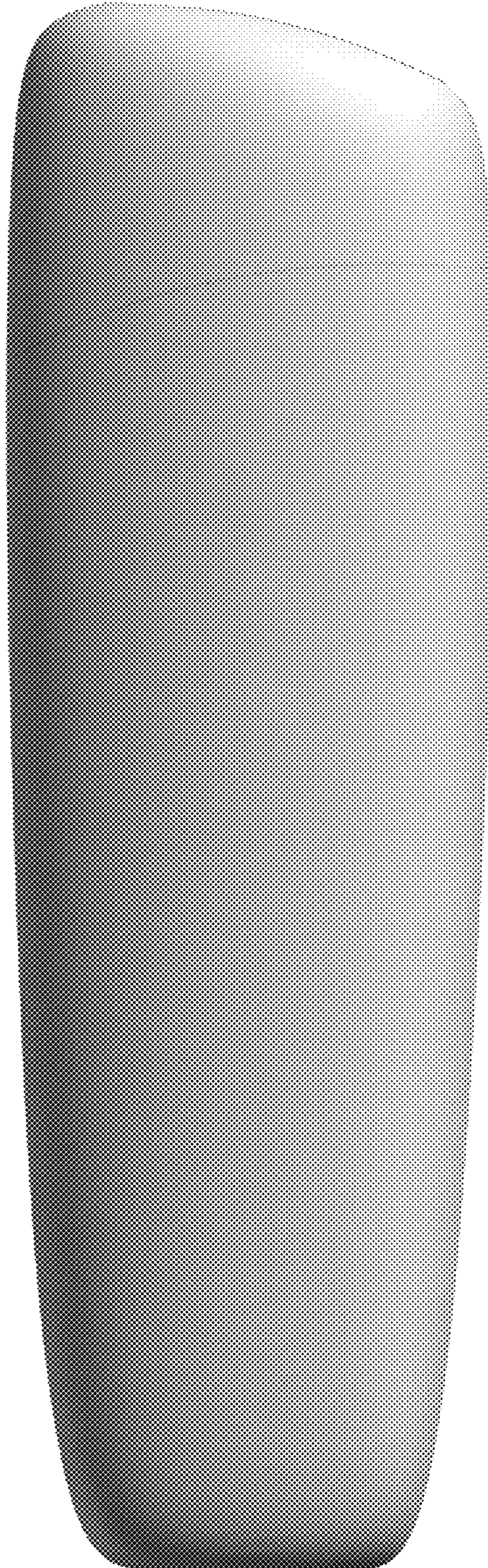

31.3

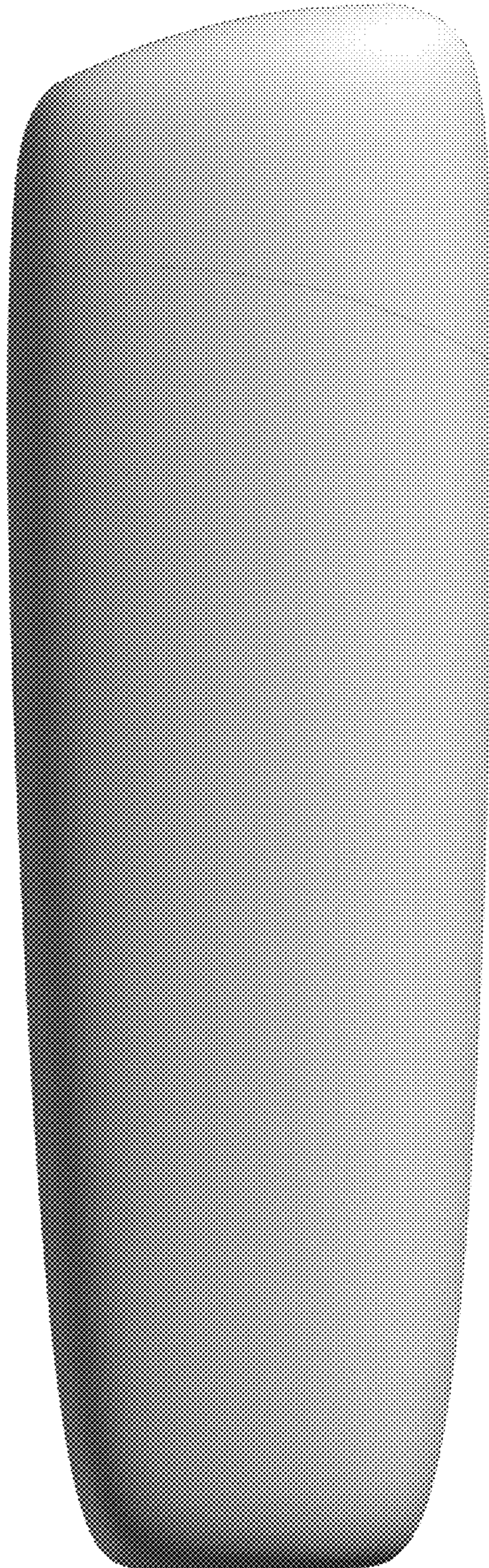

31.4

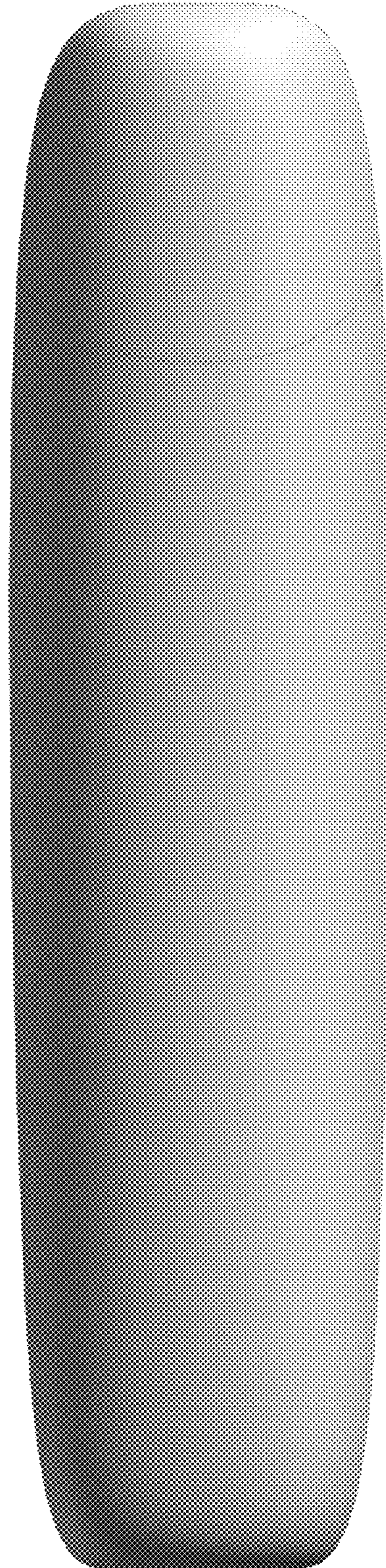

31.5

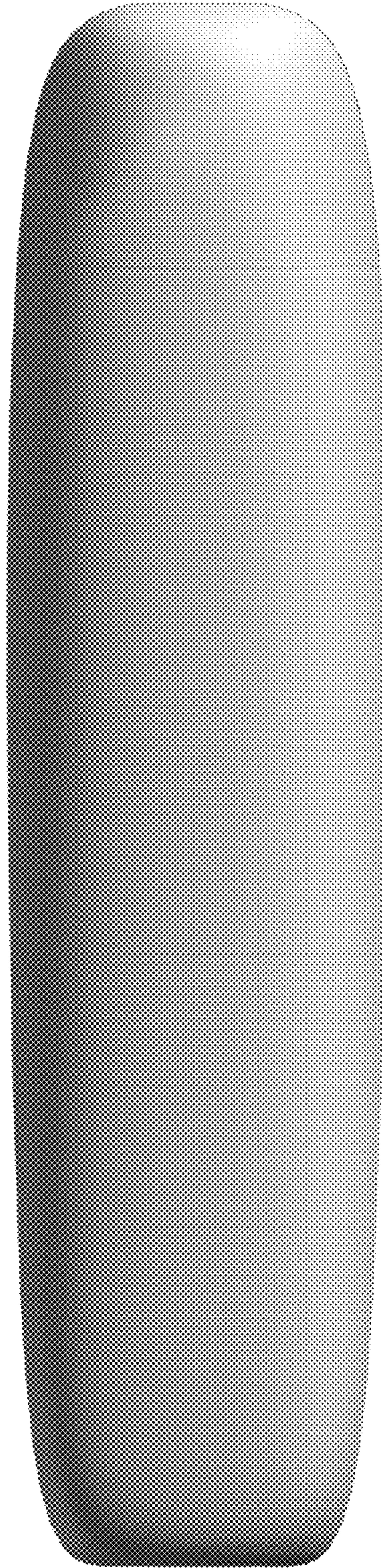

31.6



31.7

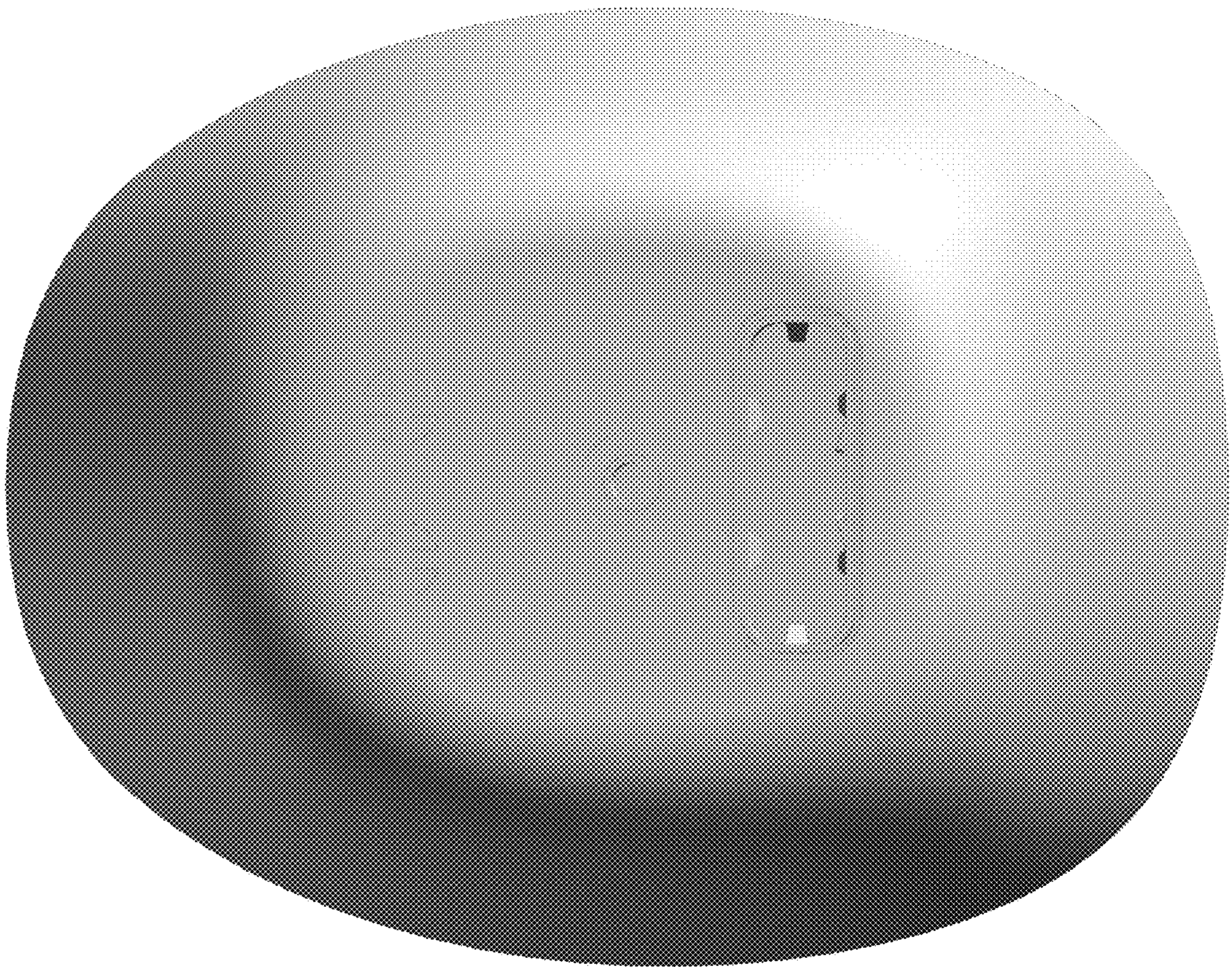

37.1

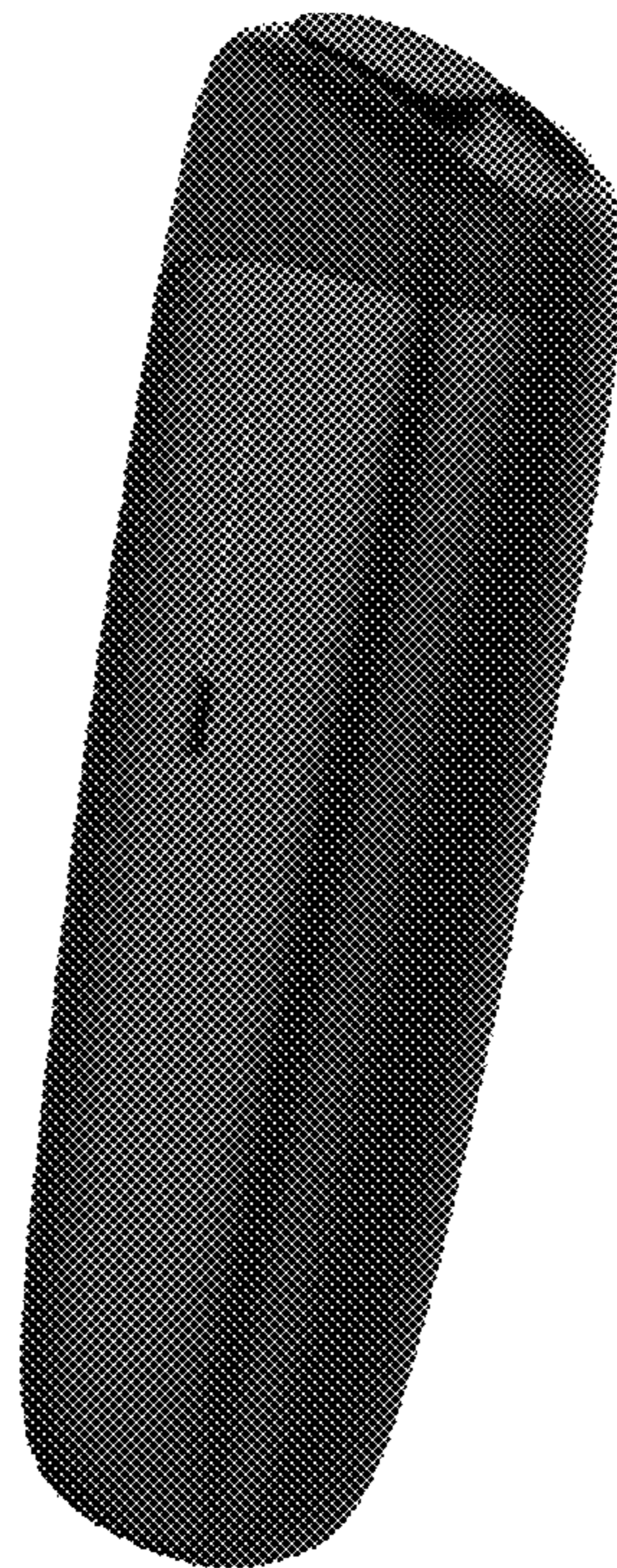

37.2

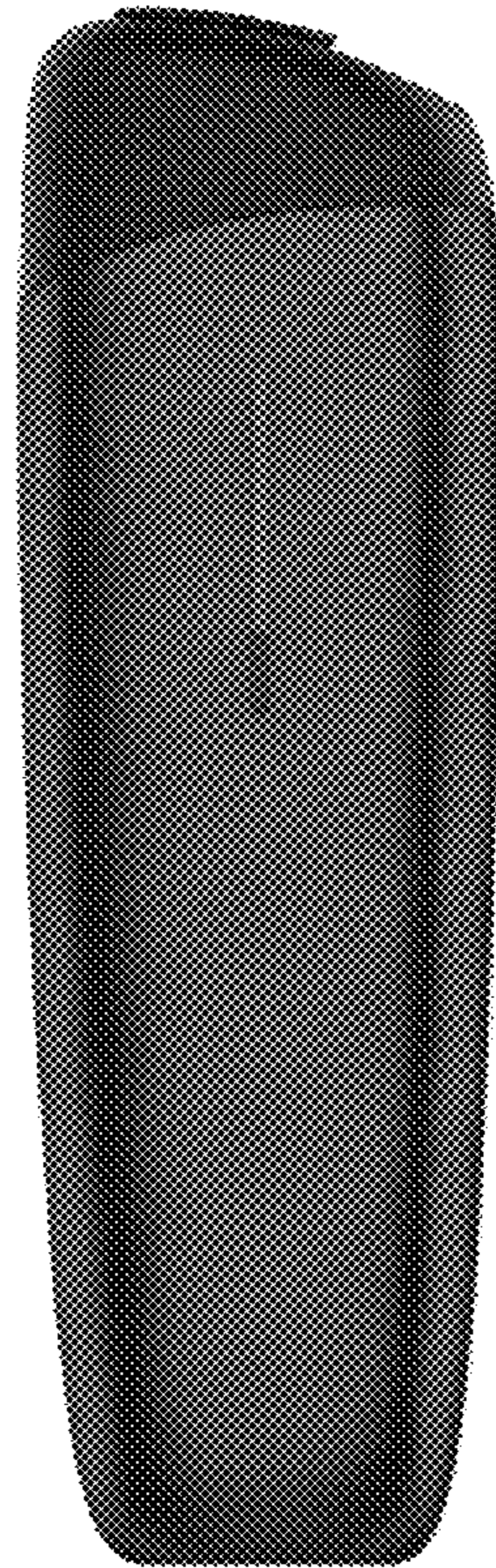

37.3

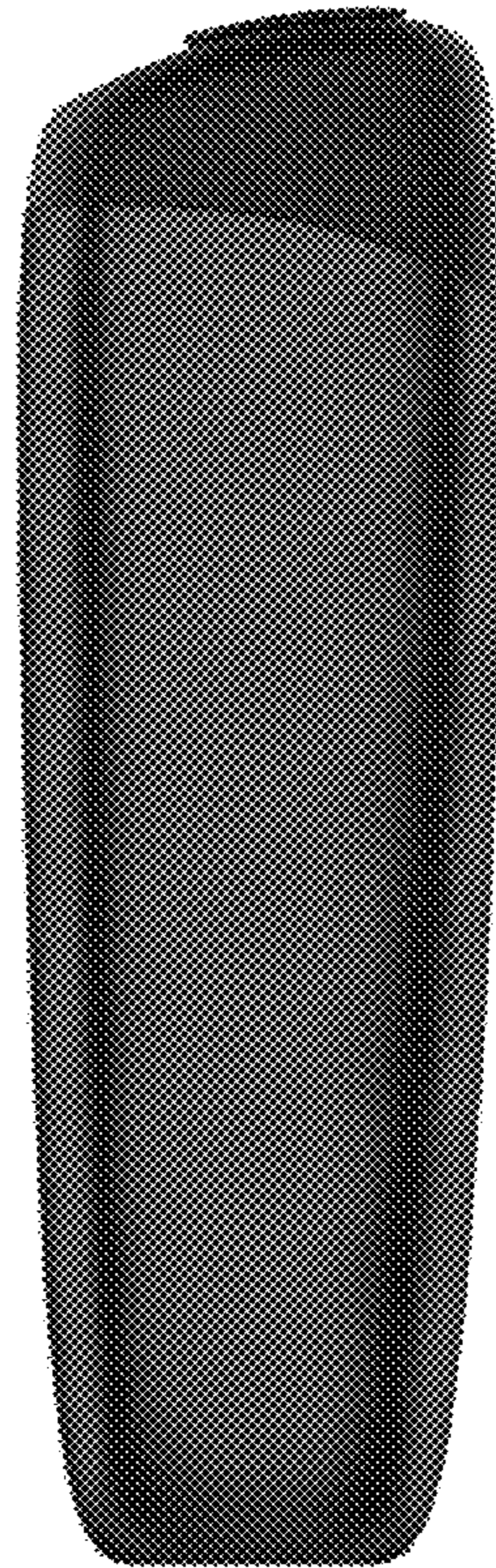

37.4

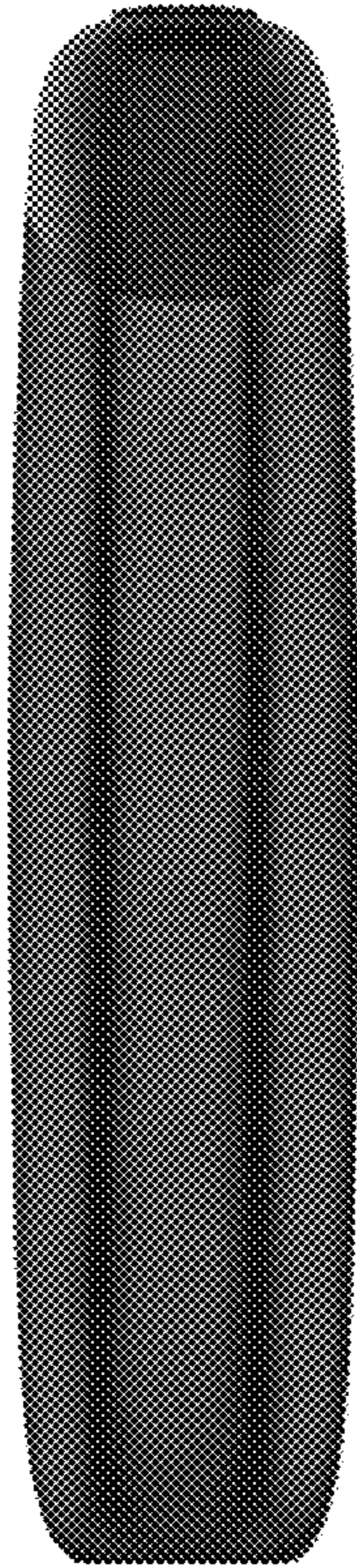

37.5

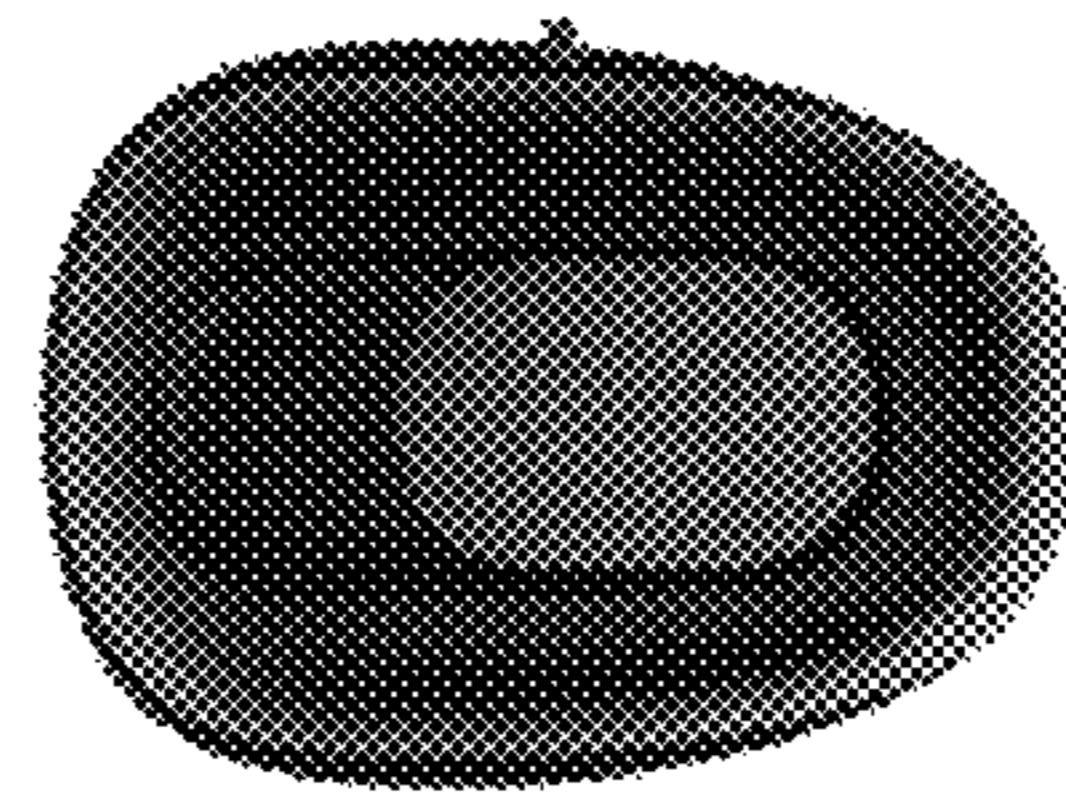

38

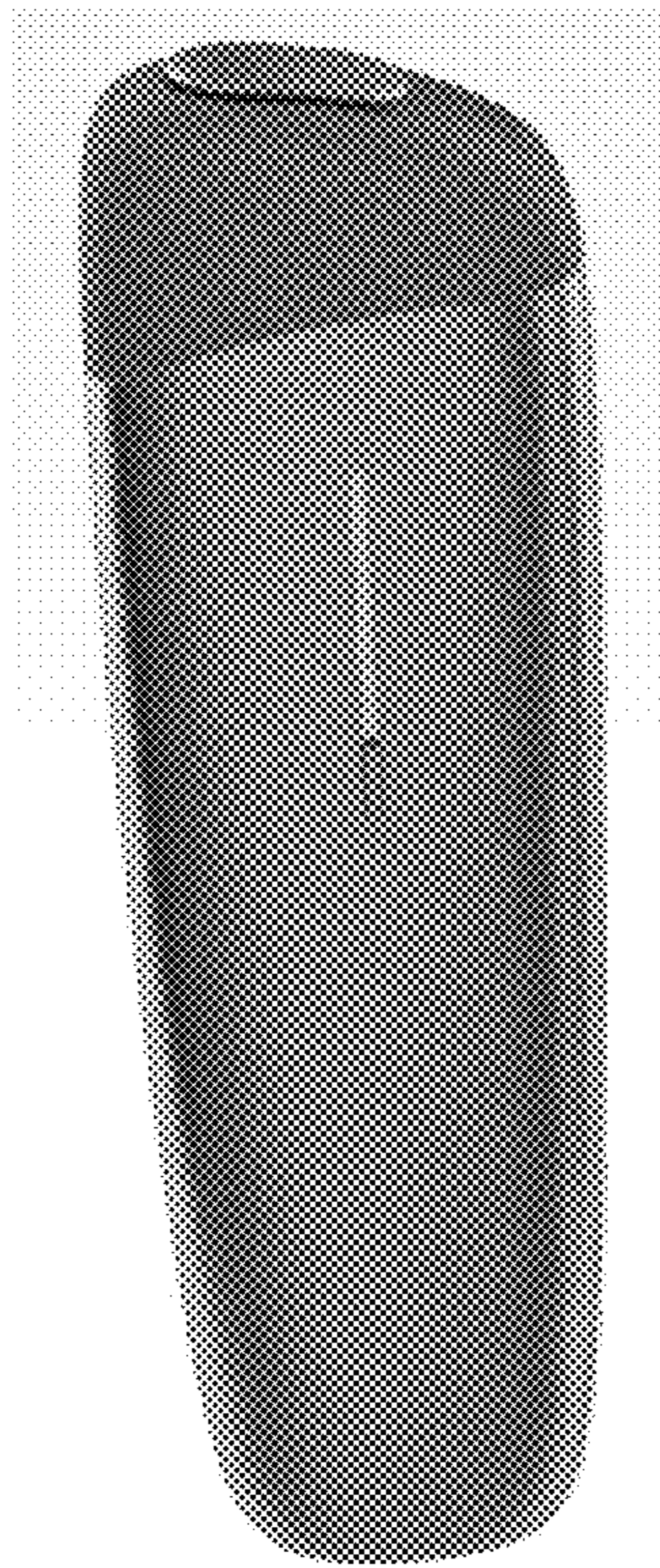

39

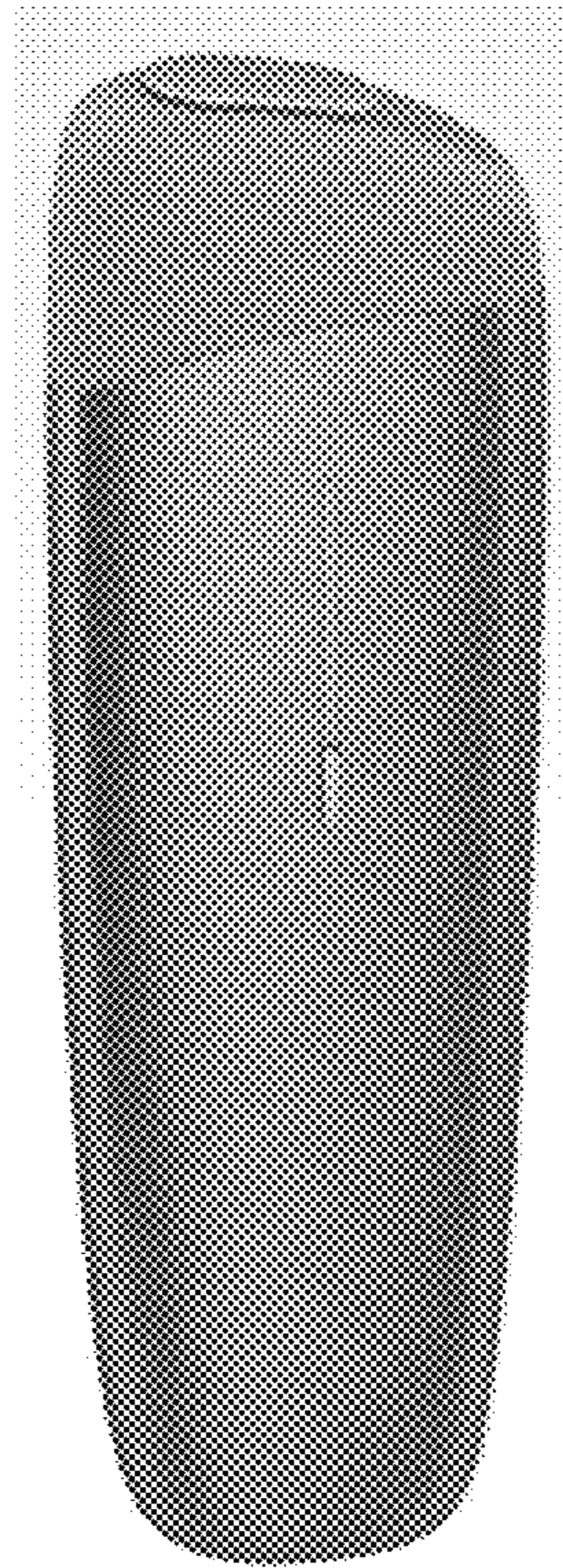

40

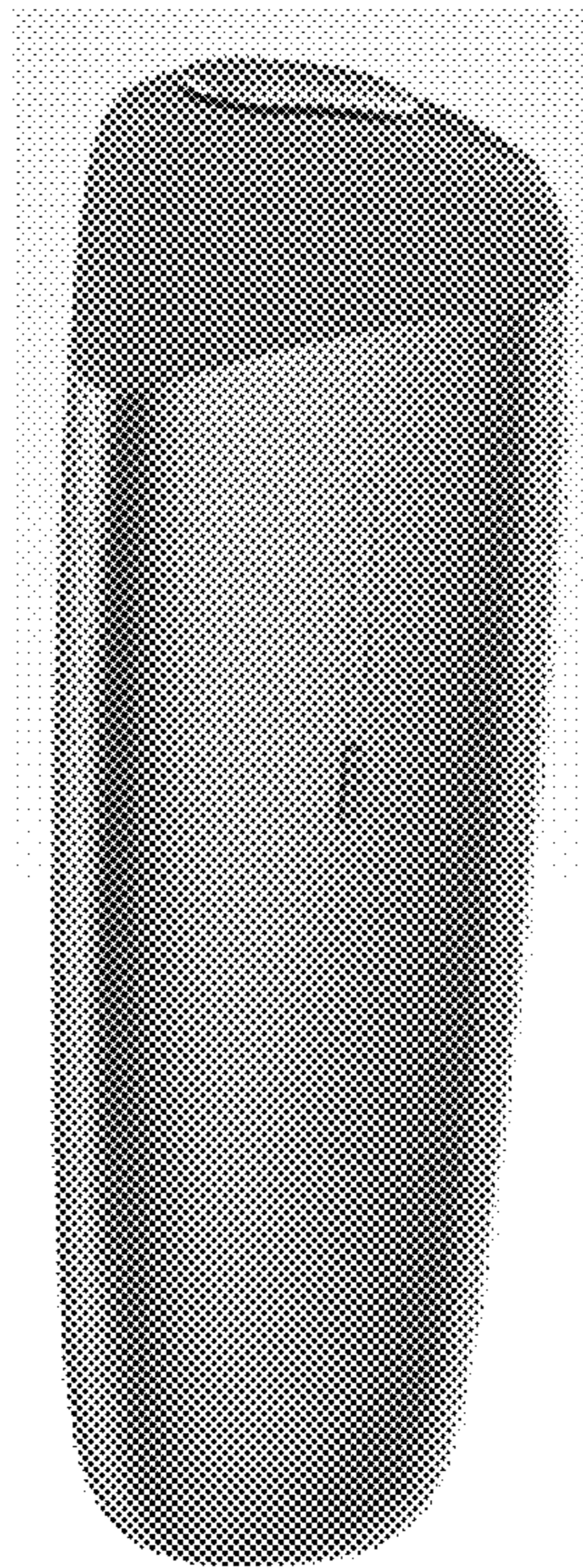

41

