



US00D982184S

(12) **United States Design Patent**
Ren

(10) **Patent No.:** **US D982,184 S**
(45) **Date of Patent:** **** Mar. 28, 2023**

(54) **BARN DOOR**

D664,673 S * 7/2012 Paxton D25/48.3
10,563,450 B2 * 2/2020 Groff E05D 15/063
D952,187 S * 5/2022 Zheng D25/48.3

(71) Applicant: **DESSLIY INC**, Pomona, CA (US)

(72) Inventor: **Huaiqing Ren**, Diamond Bar, CA (US)

FOREIGN PATENT DOCUMENTS

(**) Term: **15 Years**

KR 3020200001750 * 12/2020

(21) Appl. No.: **29/858,070**

OTHER PUBLICATIONS

(22) Filed: **Oct. 27, 2022**

18diamond <https://secure.img1-ag.wfcdn.com/dm/document/99b32911-e8e1-444b-b25e-6b4f26db45a7/18diamond.pdf> Sep. 15, 2022 (Year: 2022).*

(51) **LOC (14) Cl.** **25-02**

(52) **U.S. Cl.**

* cited by examiner

USPC **D25/48.3**

(58) **Field of Classification Search**

USPC D25/48.1, 48.3, 48.4, 48.5, 138
CPC E06B 3/58; E06B 3/72; E06B 3/78; E06B
3/485; E06B 3/4636; E06B 3/5892; E06B
3/7001; E06B 2003/7044; E06B
2003/7048; E06B 1/04; E06B 1/006;
E06B 1/524; E06B 5/00; E04C 2/36

Primary Examiner — Leanne Was-Englehart

(74) *Attorney, Agent, or Firm* — Che-Yang Chen; Law
Office of Michael Chen

See application file for complete search history.

(57) **CLAIM**

The ornamental design for a barn door, as shown and
described.

DESCRIPTION

(56) **References Cited**

U.S. PATENT DOCUMENTS

1,661,982 A * 3/1928 Wanat E05B 35/02
70/352
D615,212 S * 5/2010 Walsh D25/48.3
D634,856 S * 3/2011 Walsh D25/48.3
D638,956 S * 5/2011 Walsh D25/48.3
D652,150 S * 1/2012 Paxton D25/48.3
D660,980 S * 5/2012 Walsh D25/48.3

FIG. 1 is a perspective view of a barn door showing my new
design;

FIG. 2 is a front elevational view thereof;

FIG. 3 is a rear elevational view thereof;

FIG. 4 is a left side elevational view thereof;

FIG. 5 is a right side elevational view thereof;

FIG. 6 is a top plan view thereof; and,

FIG. 7 is a bottom plan view thereof.

1 Claim, 7 Drawing Sheets

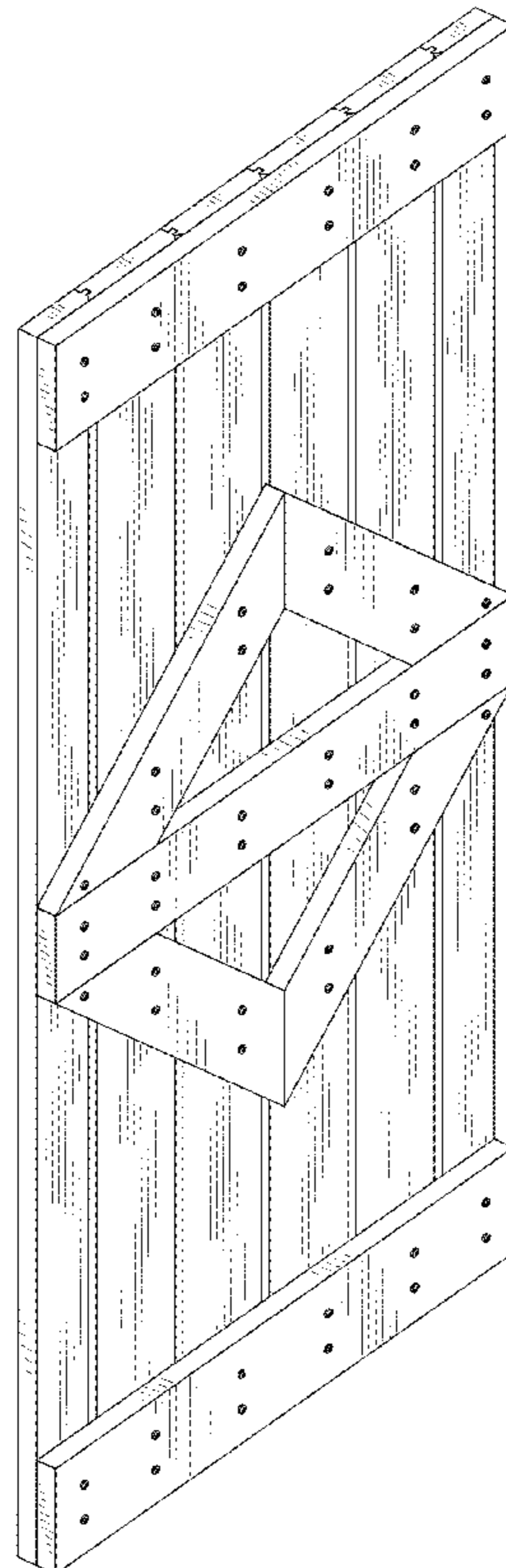

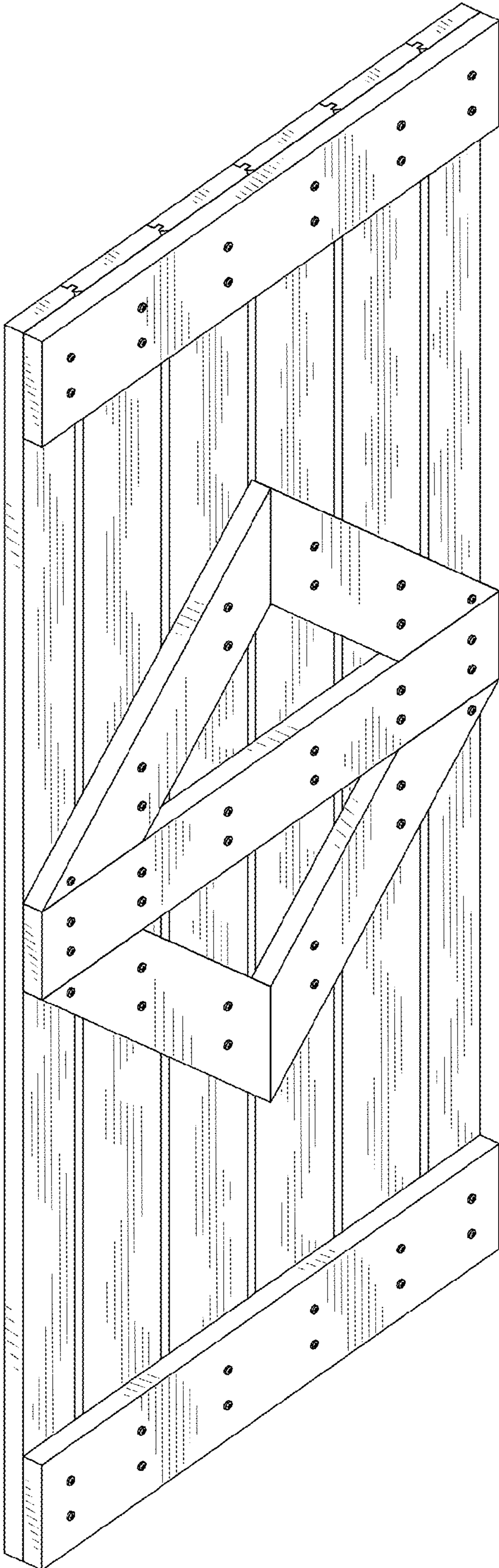

FIG. 1

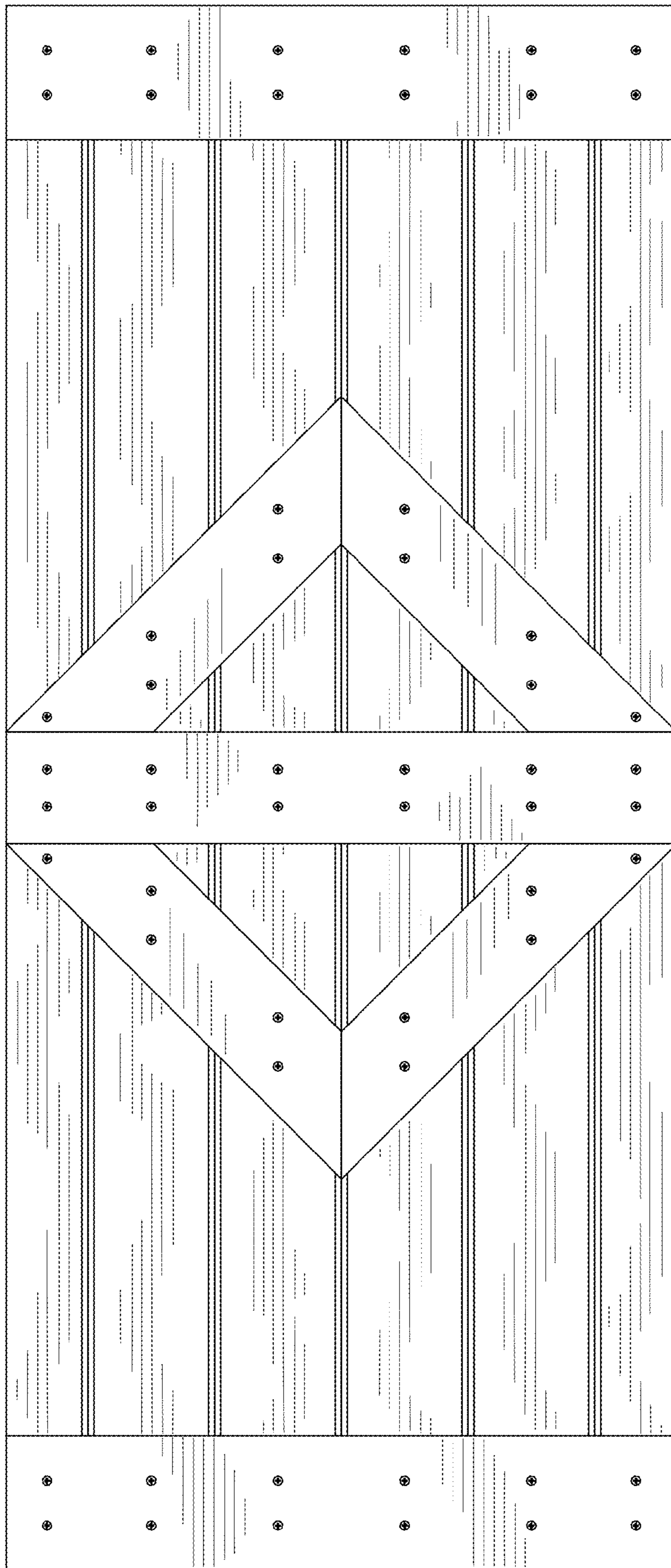

FIG. 2

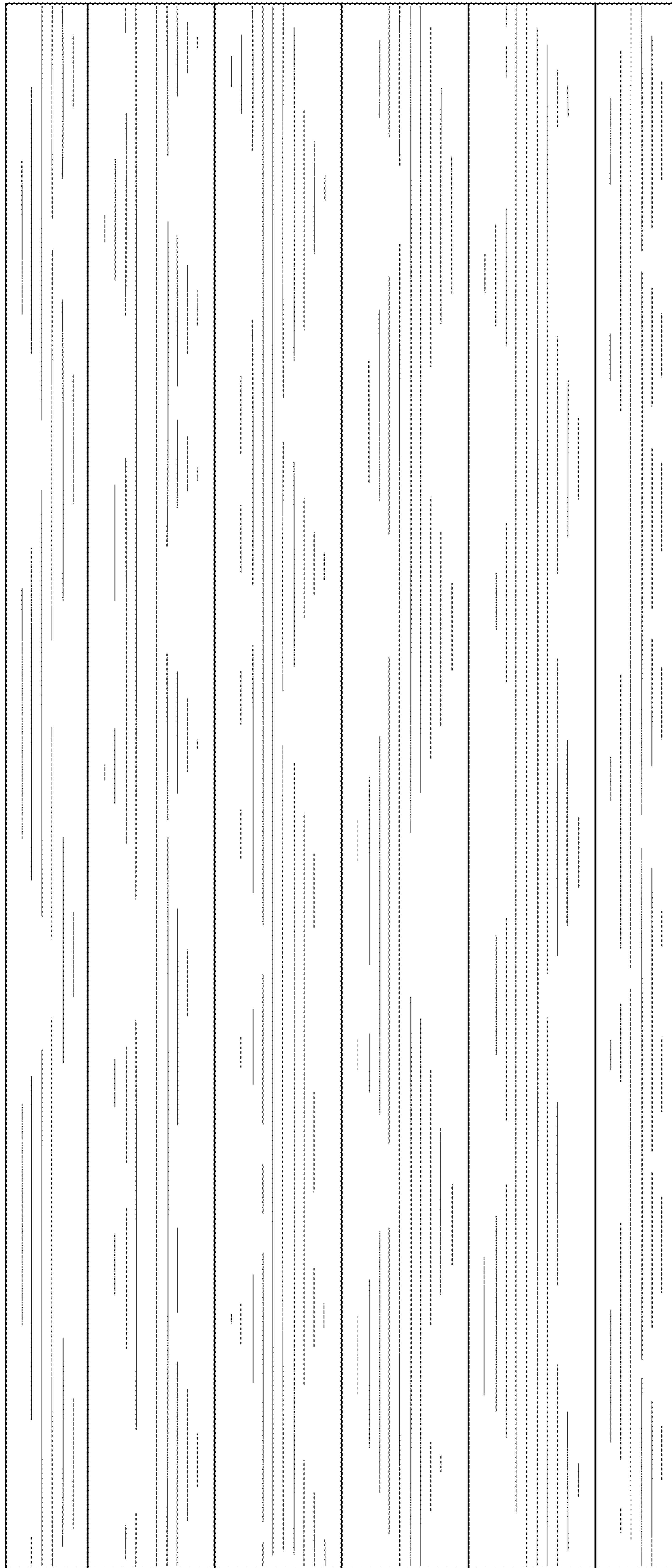

FIG. 3



FIG. 4

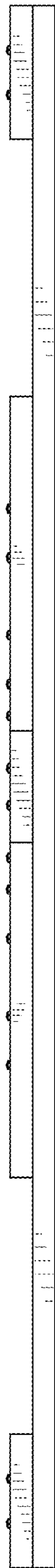

FIG. 5

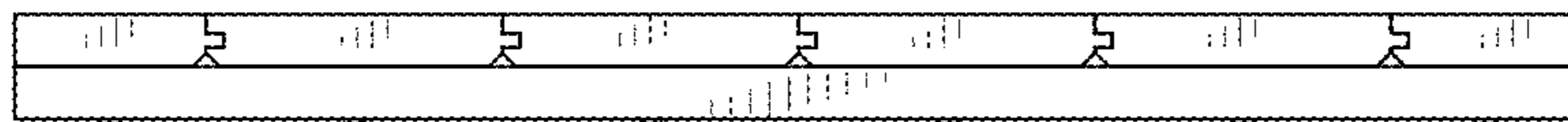

FIG. 6

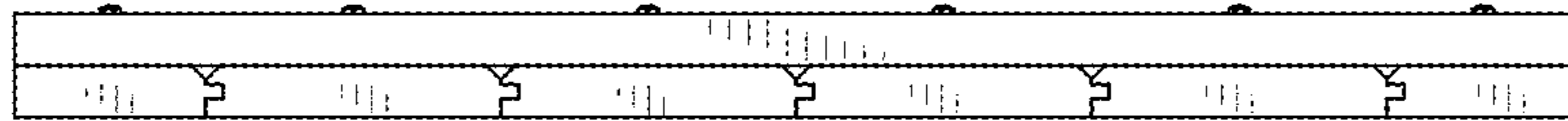

FIG. 7