



US00D982139S

(12) **United States Design Patent** (10) **Patent No.:** **US D982,139 S**
Zhao (45) **Date of Patent:** **** Mar. 28, 2023**

(54) **FAUCET**

FOREIGN PATENT DOCUMENTS

(71) Applicant: **Xiamen Weco Kitchen and Bath Industry Co., Ltd**, Fujian (CN)

CA 182053 * 12/2019
CN 3266820 * 12/2002
GB 2054936 * 7/1996

(72) Inventor: **Wei-Dong Zhao**, Xiamen (CN)

OTHER PUBLICATIONS

(73) Assignee: **Xiamen Weco Kitchen and Bath Industry Co., Ltd**, Fujian (CN)

GOWIN Oil Rubbed Bronze Bathroom Faucet, first available Sep. 4, 2019[online], [site visited Nov. 14, 2022]. Available from internet, URL:<<https://www.amazon.com/GOWIN-Bathroom-Assembly-2-Handle-Centerset/dp/B0823N6G2S>> (Year: 2019).*

(**) Term: **15 Years**

Kingston Brass KB3615AX Restoration Deck Mount Lavatory Faucet, first available Feb. 27, 2008[online], [site visited Nov. 14, 2022]. Available from internet, URL:<<https://www.amazon.com/dp/B000COJ3WK>> (Year: 2008).*

(21) Appl. No.: **29/795,661**

(22) Filed: **Jun. 19, 2021**

(30) **Foreign Application Priority Data**

* cited by examiner

Dec. 21, 2020 (CN) 202030787001.1
Dec. 28, 2020 (CN) 202030807556.8

Primary Examiner — David G Muller

Assistant Examiner — Jamaal Rasheed

(51) **LOC (14) Cl.** **23-01**

(74) *Attorney, Agent, or Firm* — J.H. Lin Patent Law

(52) **U.S. Cl.**

P.C.; John H. Lin

USPC **D23/242**

(58) **Field of Classification Search**

(57) **CLAIM**

USPC D23/238–244, 252, 254–255, 257, 499;
D7/398

The ornamental design for a faucet, as shown and described.

CPC F16K 31/602; F16K 31/605; F16K 31/607;
E03C 1/0412

See application file for complete search history.

DESCRIPTION

(56) **References Cited**

FIG. 1 is a front elevation view of a faucet;

FIG. 2 is a rear elevation view thereof;

FIG. 3 is a right elevation view thereof;

FIG. 4 is a left elevation view thereof;

FIG. 5 is a top plan view thereof;

FIG. 6 is a bottom plan view thereof; and,

FIG. 7 is a perspective view thereof.

The broken lines in the FIGURES show portions of the faucet which form no part of the claimed design.

U.S. PATENT DOCUMENTS

D363,975 S * 11/1995 Doughty D23/241
D384,395 S * 9/1997 Doughty D23/241
D487,500 S * 3/2004 Blattner D23/241
D488,538 S * 4/2004 Graves D23/238
D655,396 S * 3/2012 Obara D23/242
D823,438 S * 7/2018 Sieger D23/242
D855,771 S * 8/2019 Spangler D23/242
D856,488 S * 8/2019 Spangler D23/242
D942,591 S * 2/2022 Fritz D23/253

1 Claim, 7 Drawing Sheets

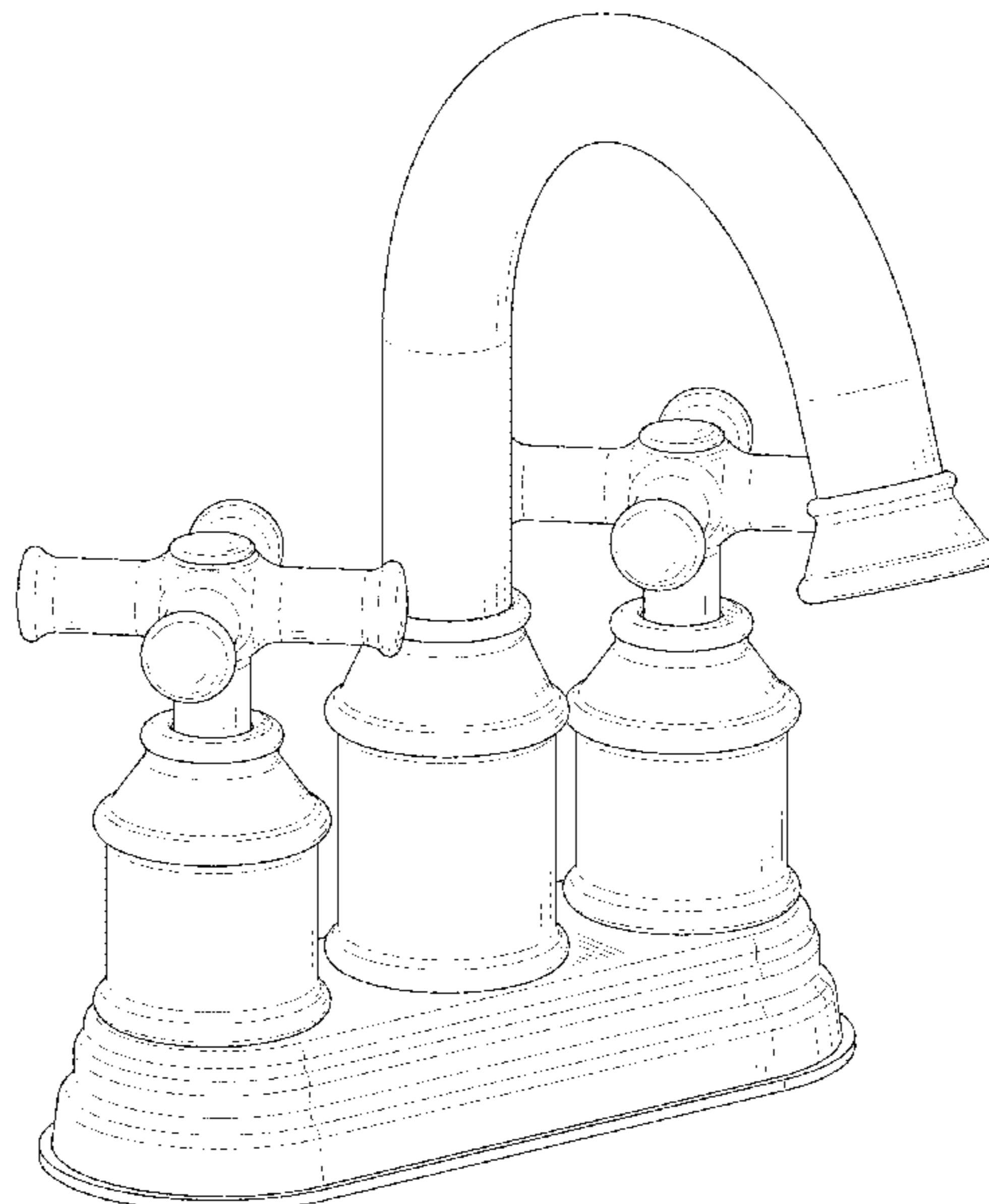

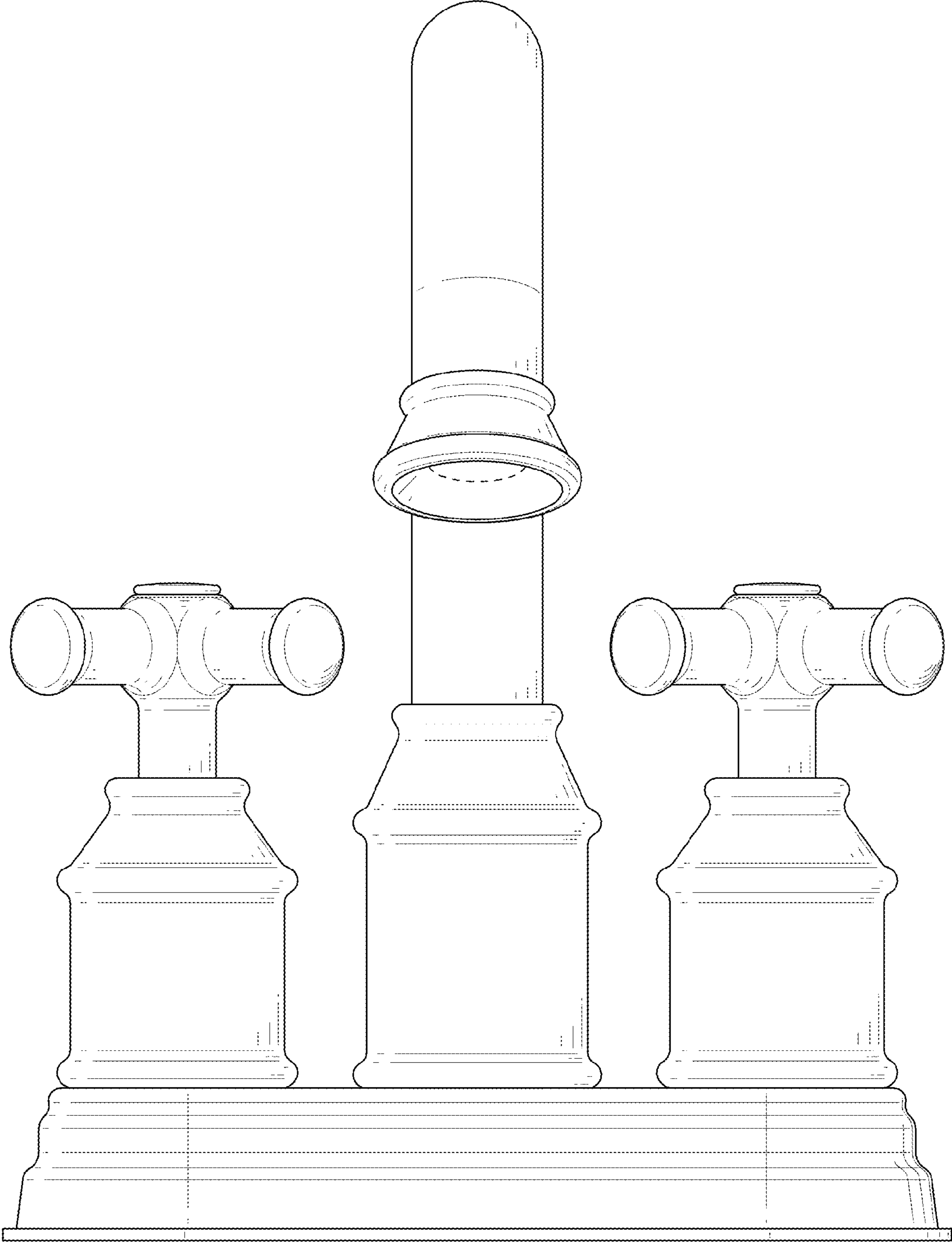

FIG. 1

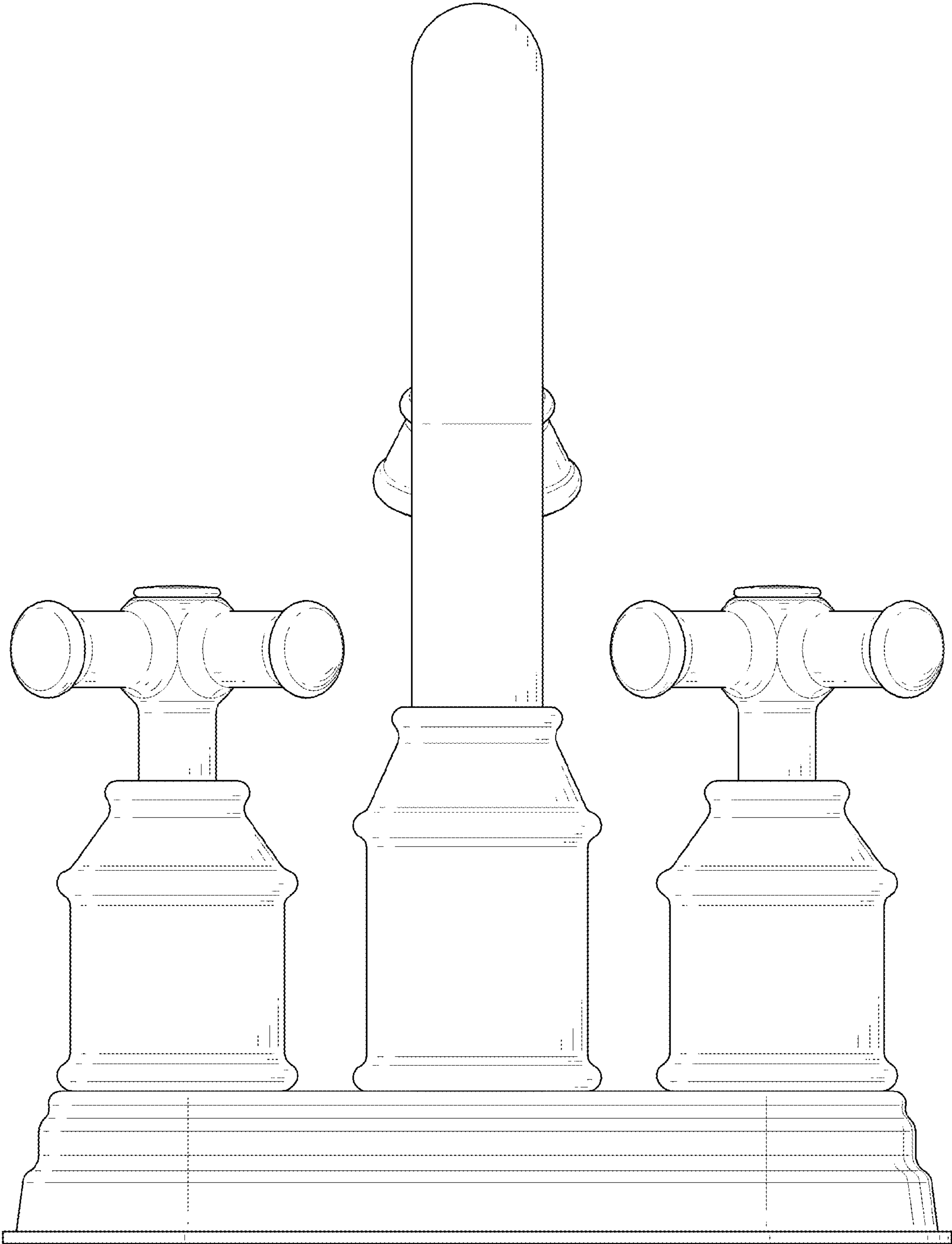

FIG. 2

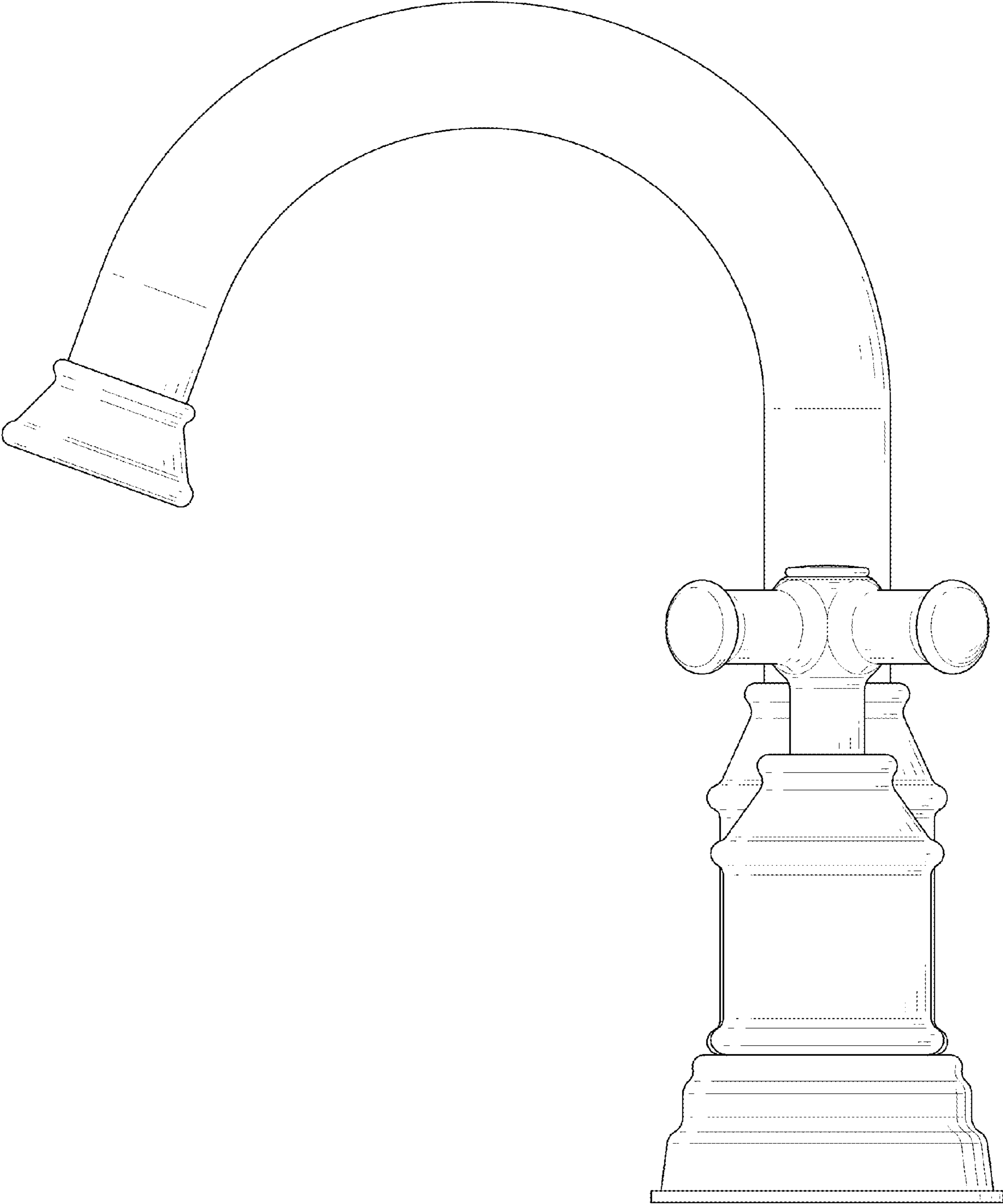

FIG. 3

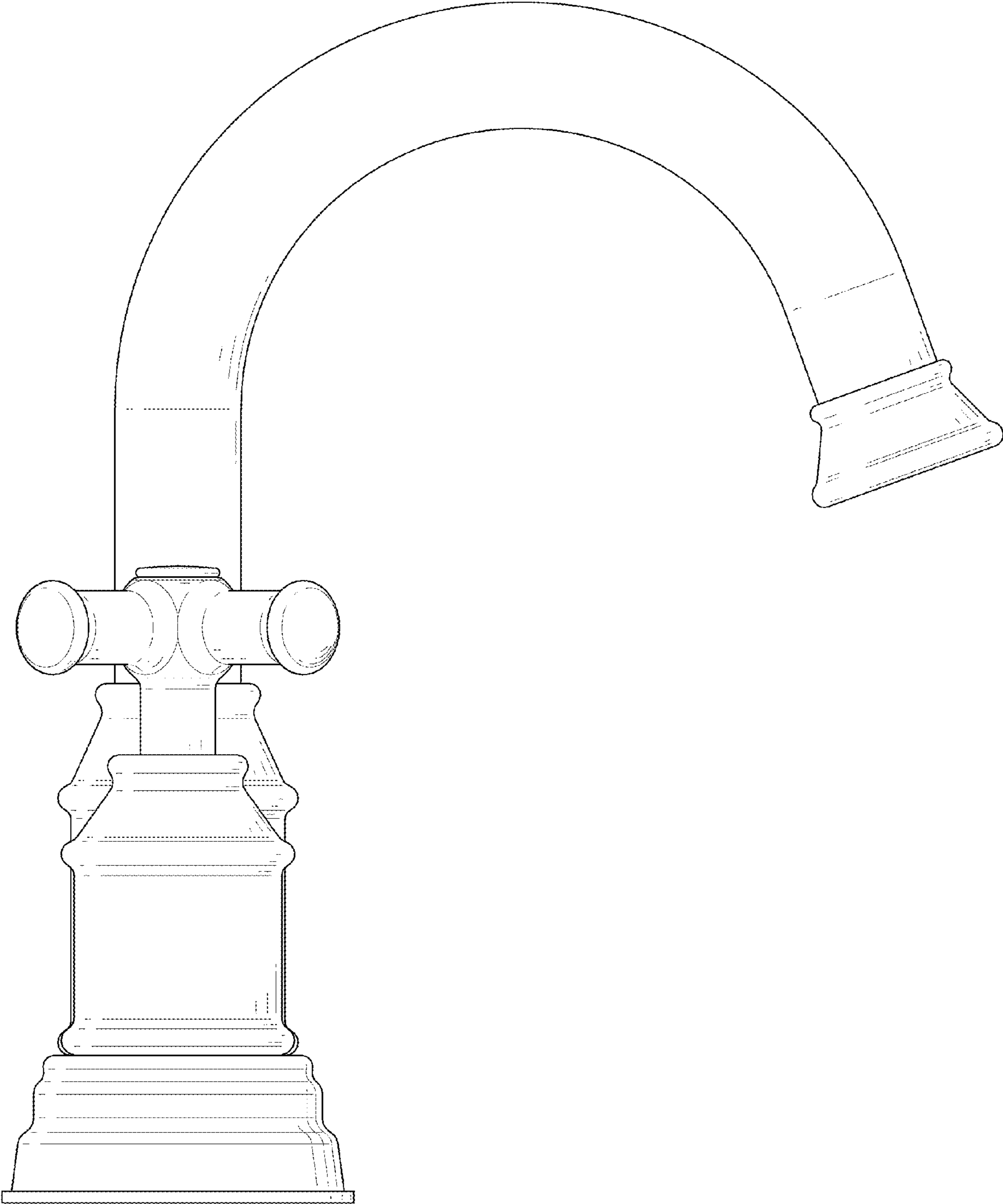

FIG. 4

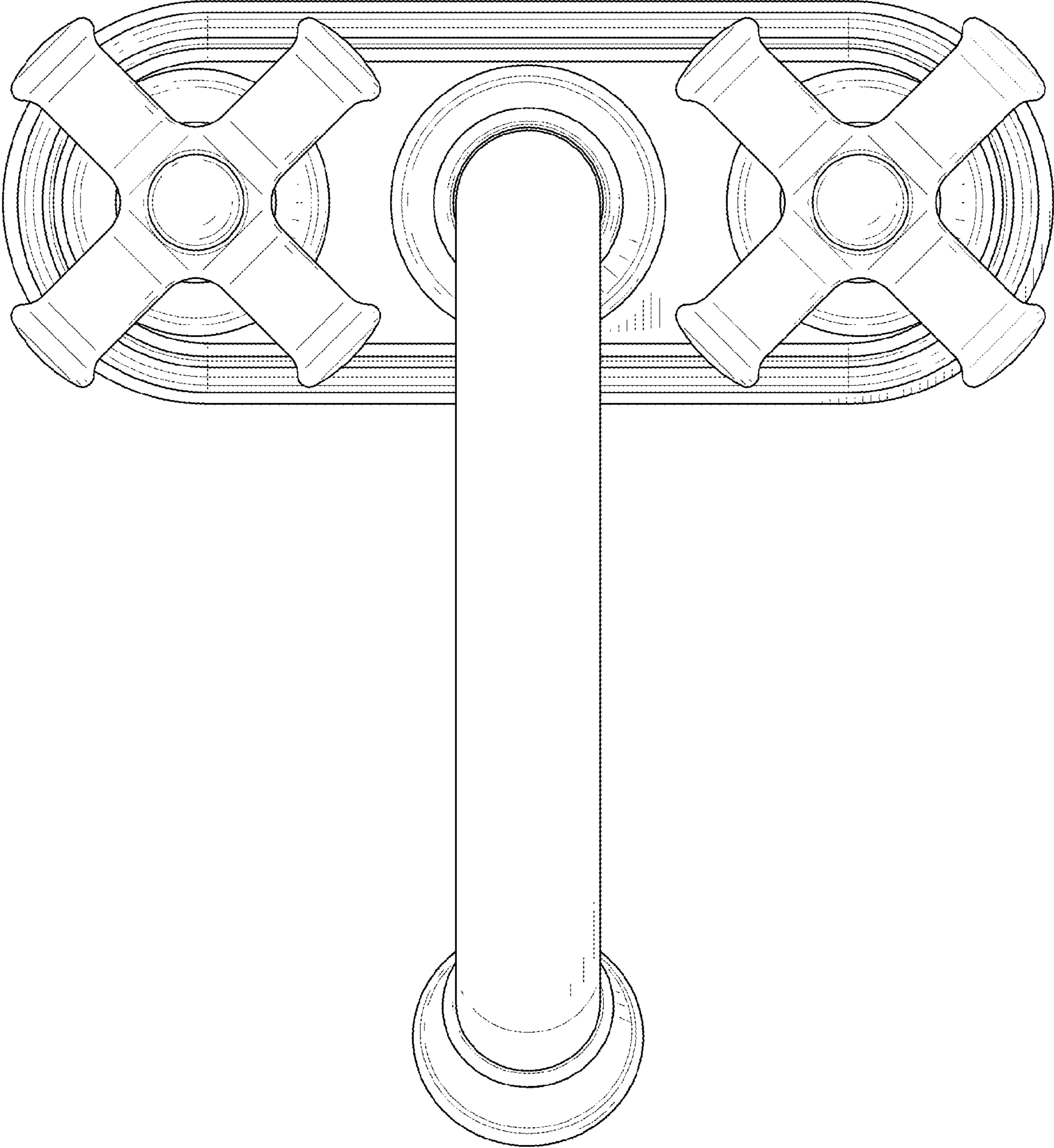

FIG. 5

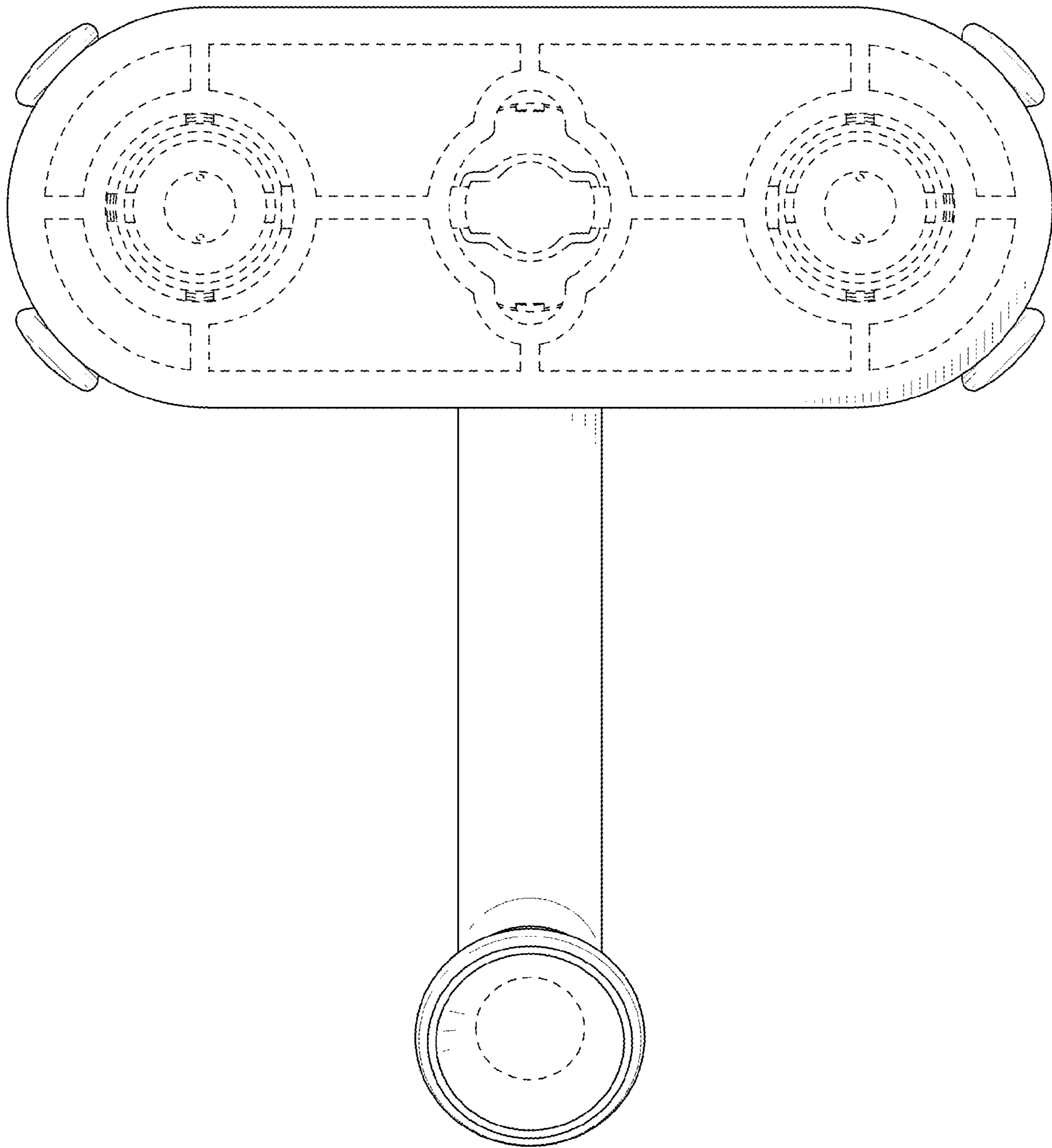

FIG. 6

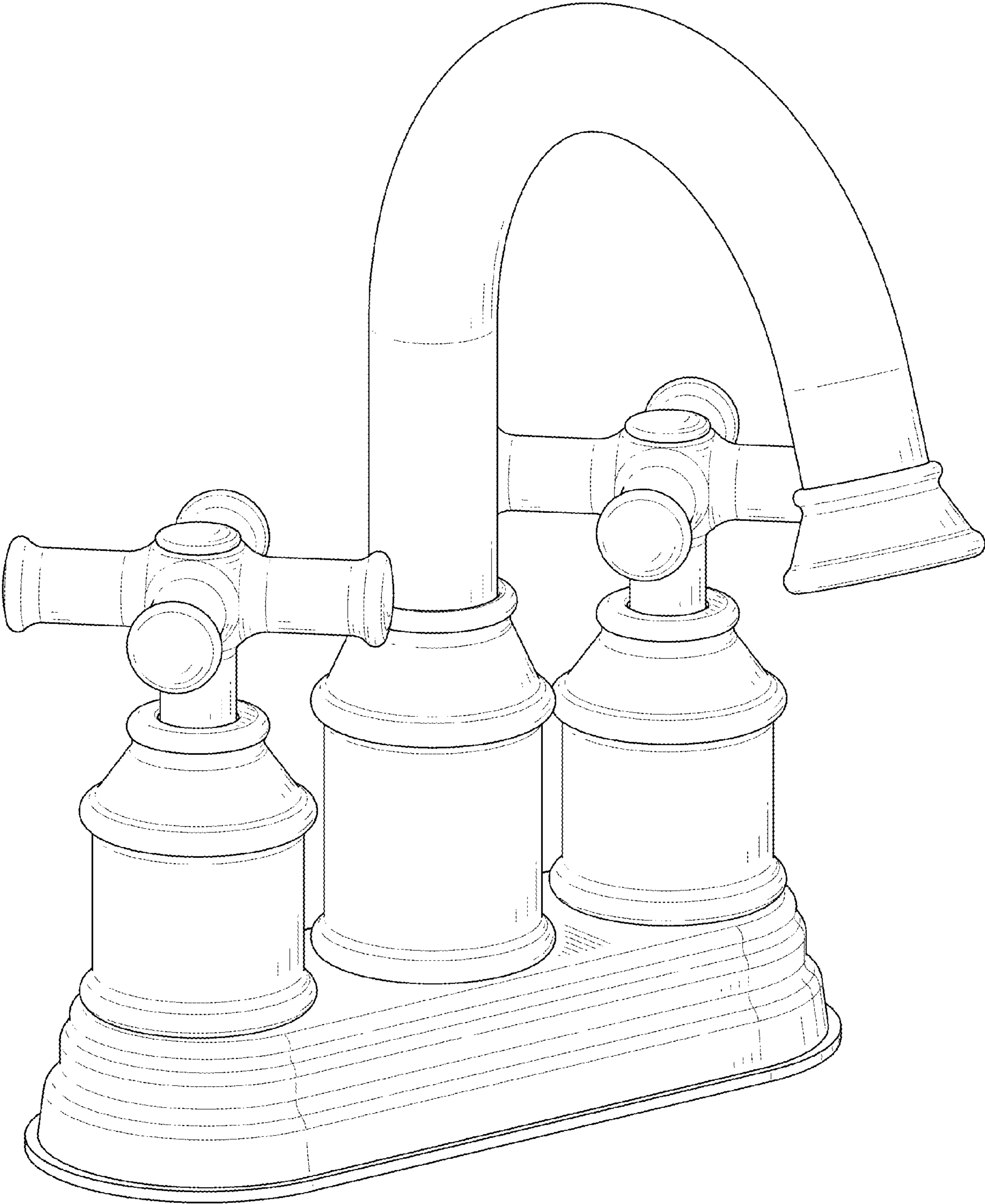

FIG. 7