



US00D982080S

(12) **United States Design Patent** (10) **Patent No.:** **US D982,080 S**
Ye (45) **Date of Patent:** **** Mar. 28, 2023**

(54) **MESH DESK ORGANIZER WITH FILE HOLDER**

(71) Applicant: **Zhihui Ye**, Zhejiang (CN)

(72) Inventor: **Zhihui Ye**, Zhejiang (CN)

(**) Term: **15 Years**

(21) Appl. No.: **29/816,128**

(22) Filed: **Nov. 18, 2021**

(51) **LOC (14) Cl.** **19-02**

(52) **U.S. Cl.**
USPC **D19/92**

(58) **Field of Classification Search**
USPC D19/92, 75-91, 99, 135; D3/206, 304, D3/306, 310, 315; D6/675.5, 683, 683.1; D7/631, 637-641; D9/427, 432, 611; D14/253

CPC .. B43M 99/00; B43M 99/001; B43M 99/003; B43M 99/006; B43M 99/007; B43M 99/008; B43M 99/009; B42D 3/12; B42D 3/16; B42D 3/18; B43K 23/001; B43K 23/002; A47B 55/00; A47B 63/00

See application file for complete search history.

(56) **References Cited**

U.S. PATENT DOCUMENTS

D176,591 S *	1/1956	Brown	D6/661
D433,711 S *	11/2000	Andujar	D19/83
D455,459 S *	4/2002	Cheris	D19/90
D473,592 S *	4/2003	Hardy	D19/78
D579,691 S *	11/2008	Snider	D6/675.4
7,481,327 B2 *	1/2009	Cheng	B65D 7/16 206/509
D628,445 S *	12/2010	Snider	D7/600.1
D683,963 S *	6/2013	Tsai	D3/304
D689,549 S *	9/2013	Hu	D19/90
D689,942 S *	9/2013	Hu	D19/78
D784,698 S *	4/2017	Goodman	D3/306
D798,952 S	10/2017	Tsai		

D856,420 S *	8/2019	Tsai	D19/92
D857,094 S	8/2019	Addison		
D875,476 S *	2/2020	Tuang	D7/600.4
D904,516 S *	12/2020	Tsai	D19/92
D920,675 S *	6/2021	Shu	D3/306
D923,707 S *	6/2021	Hu	D19/92

(Continued)

FOREIGN PATENT DOCUMENTS

CN	306642926	*	6/2021
CN	306750331	*	8/2021
CN	306761888	*	8/2021

(Continued)

OTHER PUBLICATIONS

Marbrasse Desktop File Organizer with Pen Holders posted by Marbrasse posted date Aug. 11, 2020, © Amazon, [online], [site visited Jul. 14, 2022]. Available from Internet, <https://www.amazon.com/Marbrasse-4-Trays-Desktop-Organizer-Supplies/dp> (Year: 2020).*

(Continued)

Primary Examiner — Garth Rademaker

Assistant Examiner — Laura H Yu

(57) **CLAIM**

The ornamental design for a mesh desk organizer with file holder, as shown and described.

DESCRIPTION

FIG. 1 is a perspective view of a mesh desk organizer with file holder showing my new design; FIG. 2 is a front view thereof; FIG. 3 is a back view thereof; FIG. 4 is a left side view thereof; FIG. 5 is a right side view thereof; FIG. 6 is a top plan view thereof; and, FIG. 7 is a bottom plan view thereof.

1 Claim, 7 Drawing Sheets

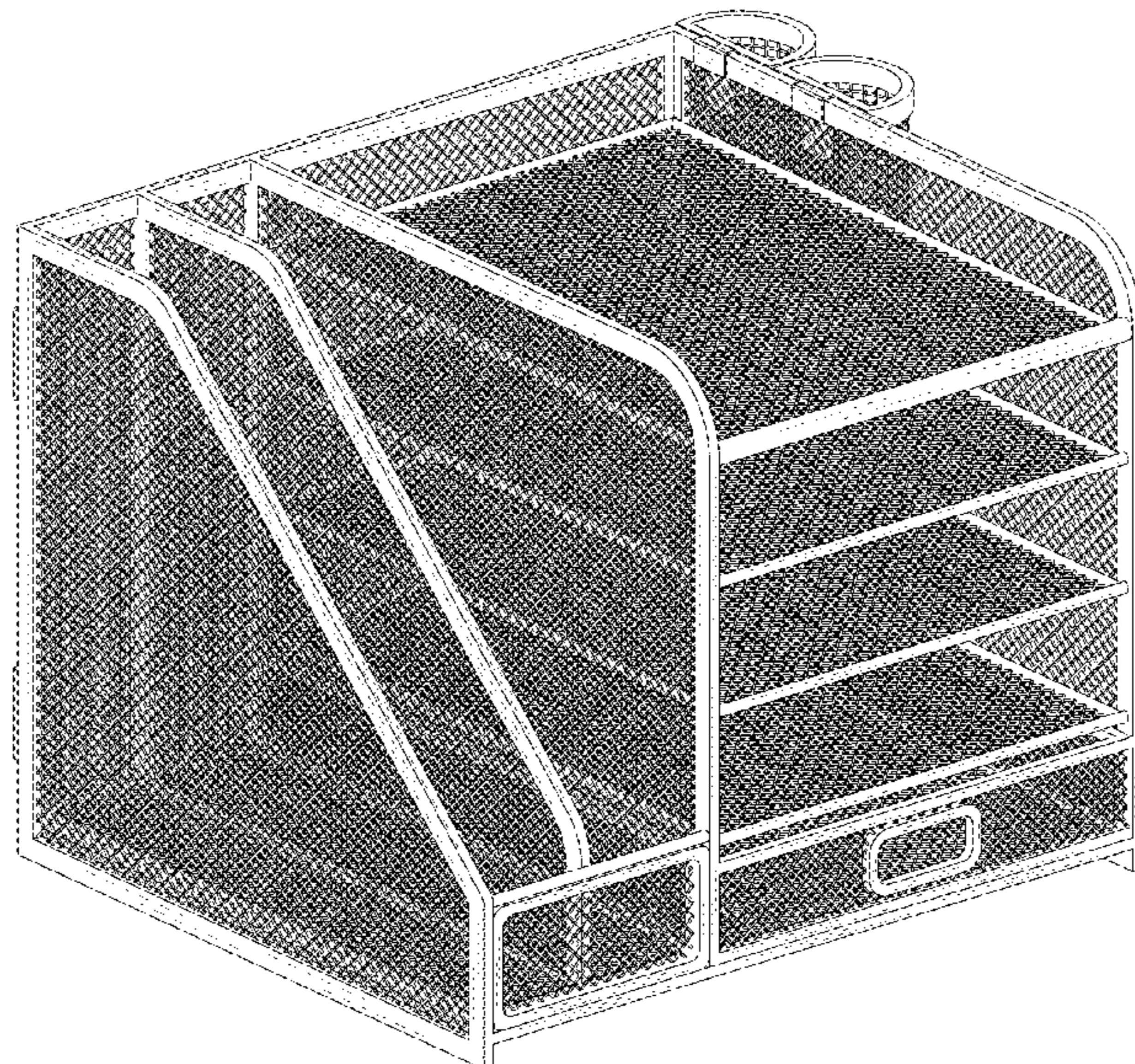

(56)

References Cited

U.S. PATENT DOCUMENTS

D924,327 S * 7/2021 Tsai D19/92
D956,867 S * 7/2022 Chien D19/92

FOREIGN PATENT DOCUMENTS

CN 306862954 * 10/2021
CN 306862955 * 10/2021
CN 306929299 * 11/2021

OTHER PUBLICATIONS

FancoYard Mesh Desk Organizer posted by FancoYard posted date Aug. 23, 2021, © Amazon, [online], [site visited Jul. 14, 2022]. Available from Internet, <https://www.amazon.com/FancoYard-Organizers-Supplies-Organizer-Accessories/dp> (Year: 2021).*

Daltack Desk Organizer posted by Daltack posted date Mar. 15, 2021, © Amazon, [online], [site visited Jul. 14, 2022]. Available from Internet, <https://www.amazon.com/DALTACK-4-Trays-Desktop-Organizer-Supplies> (Year: 2021).*

Marbrasse Desktop File Organizer with File Holder posted by Marbrasse posted date Oct. 23, 2021, © Amazon, [online], [site visited Jul. 14, 2022]. Available from Internet, <https://www.amazon.com/Marbrasse-Organizer-Desktop-Magazine-Supplies> (Year: 2021).*

* cited by examiner

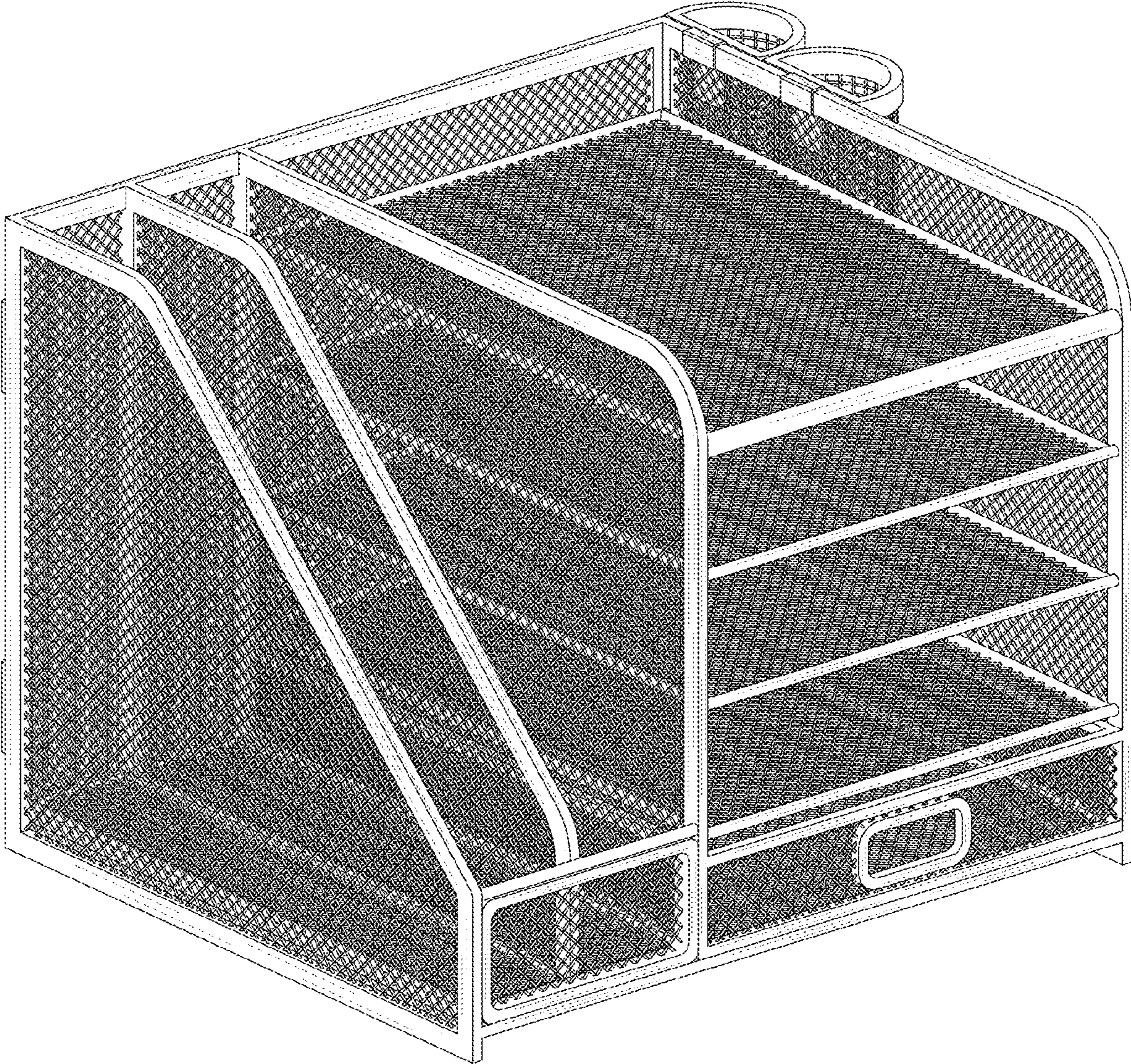

FIG. 1

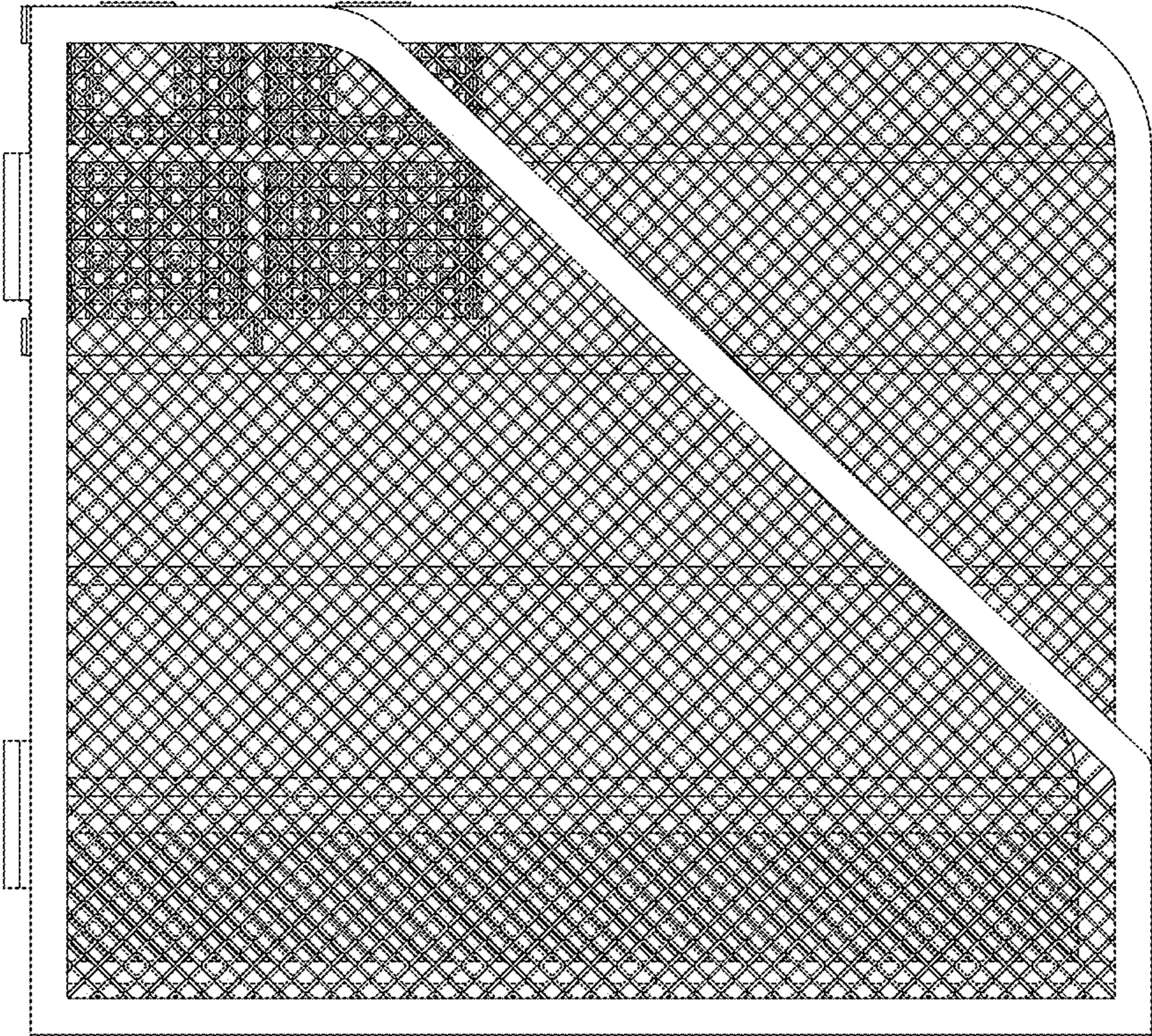

FIG. 2

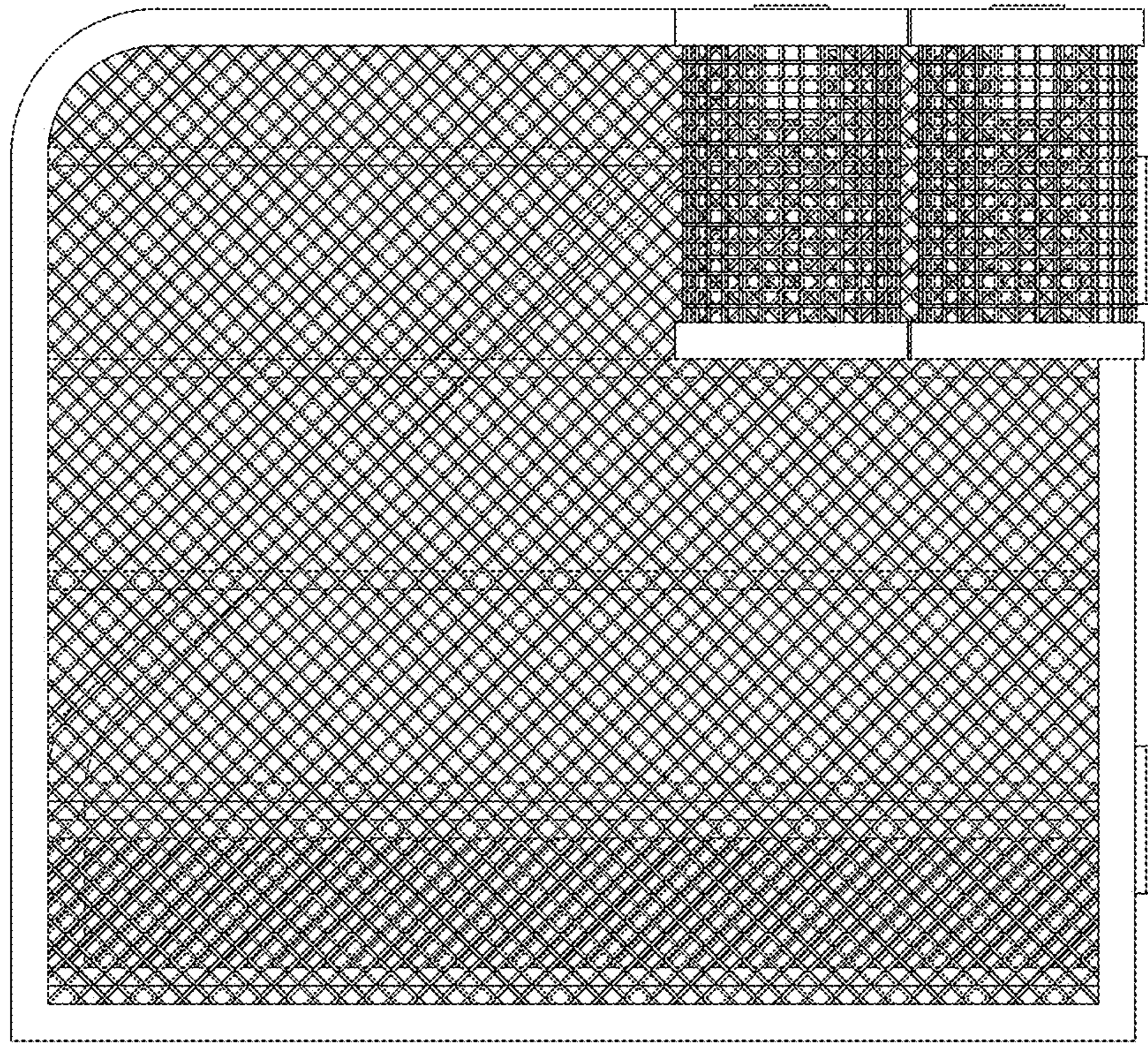

FIG. 3

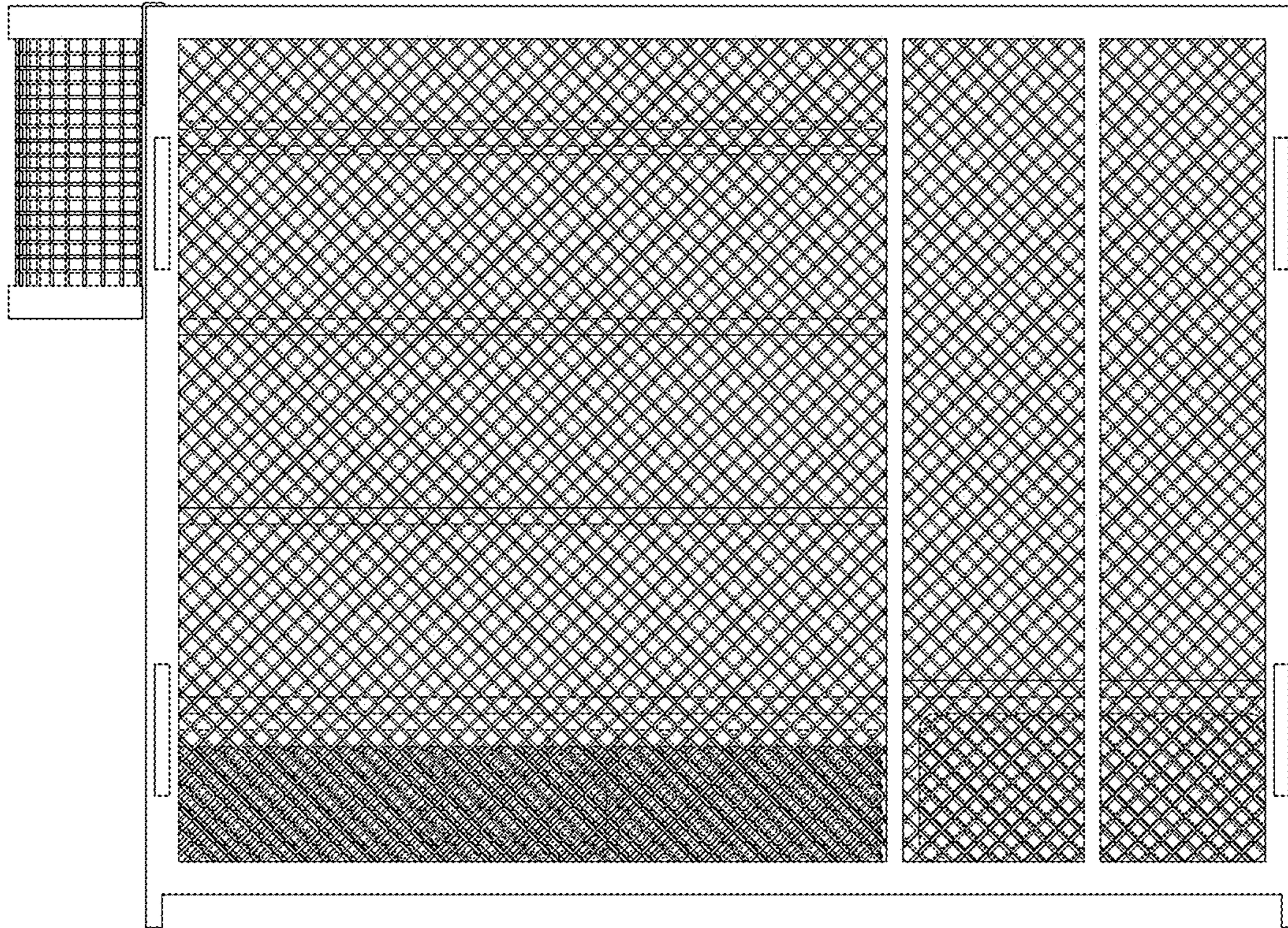

FIG. 4

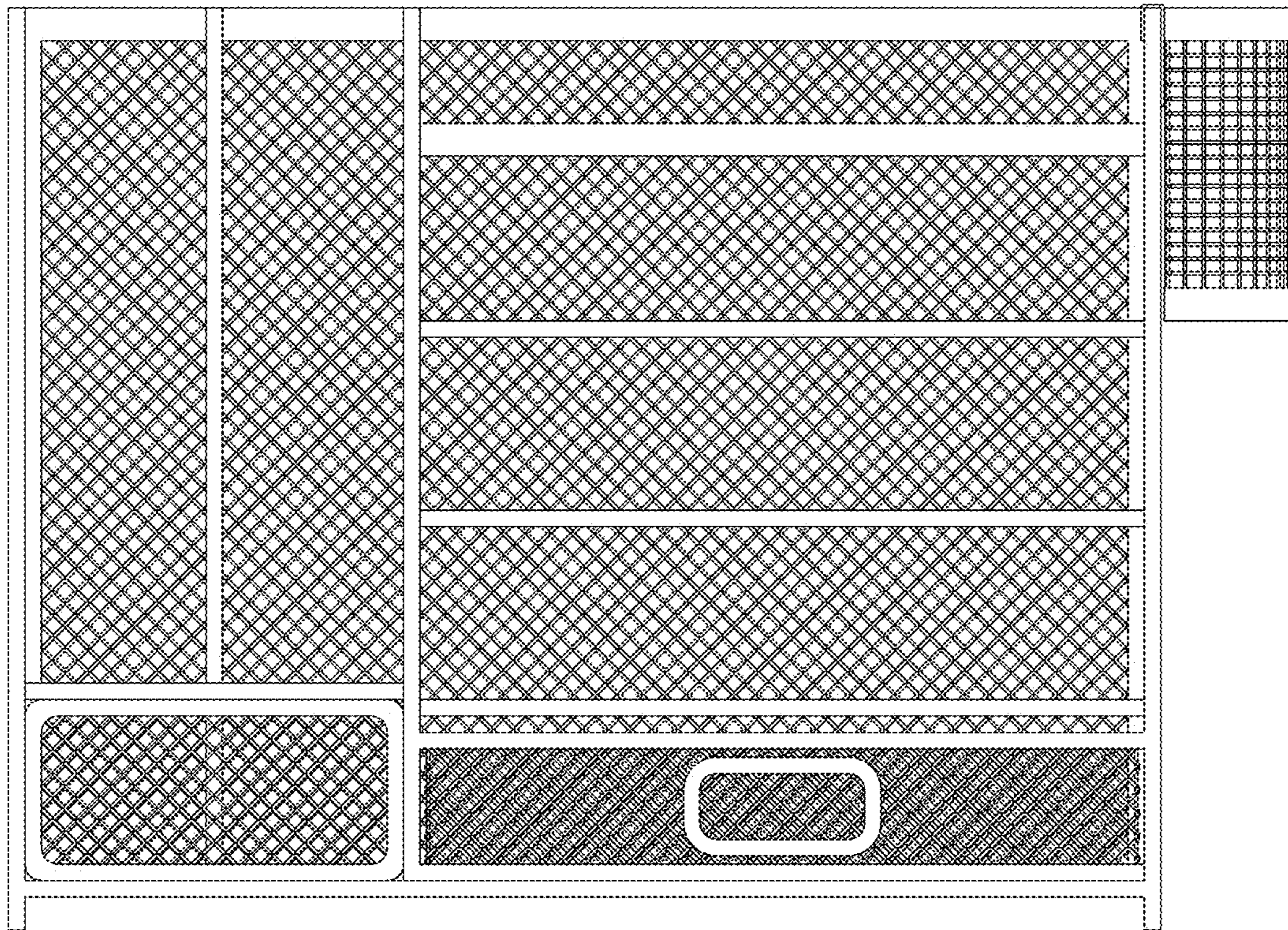

FIG. 5

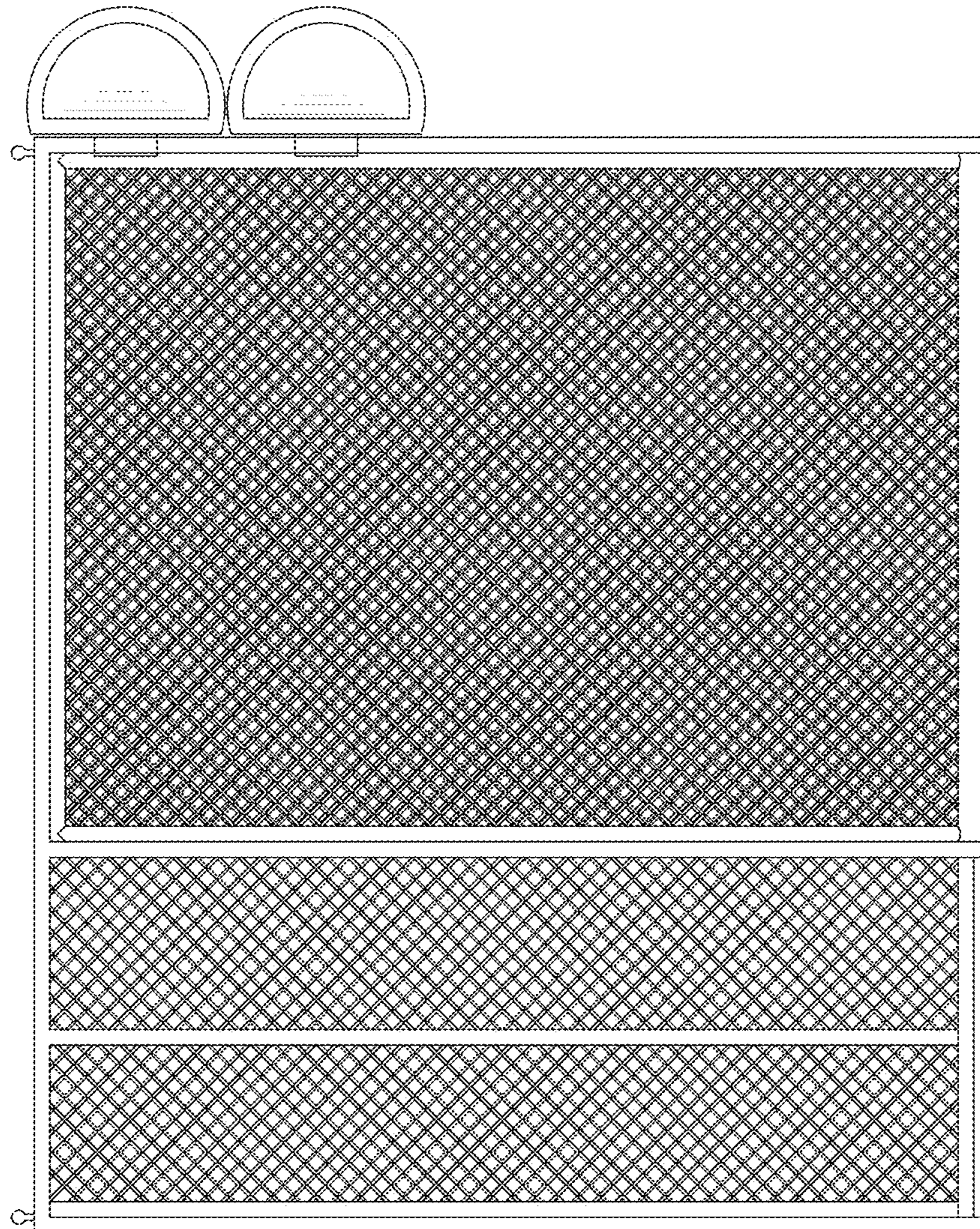

FIG. 6

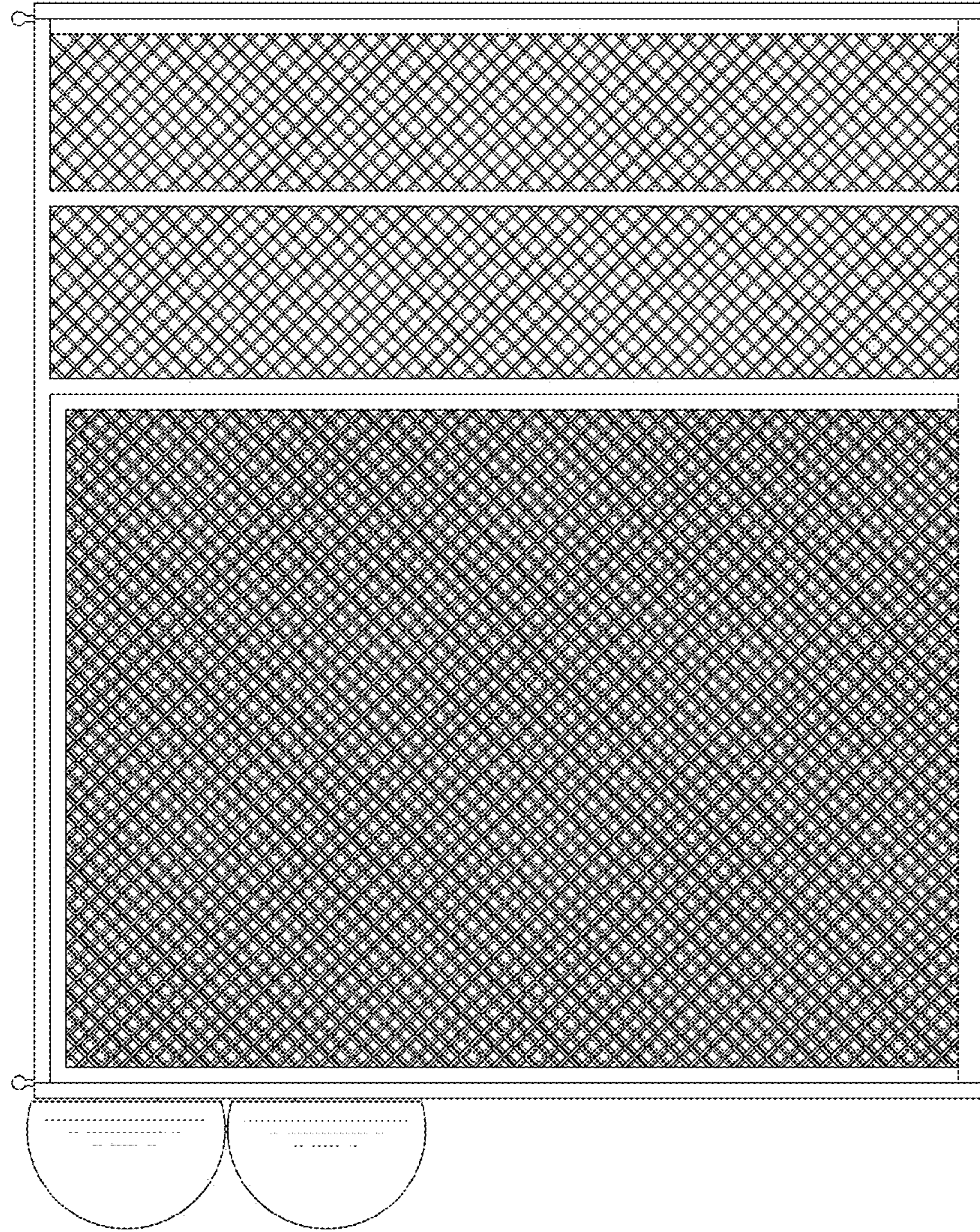

FIG. 7