



US00D982059S

(12) **United States Design Patent**  
**Tseng et al.**

(10) **Patent No.:** **US D982,059 S**  
(45) **Date of Patent:** **\*\* Mar. 28, 2023**

(54) **CAMERA**

FOREIGN PATENT DOCUMENTS

(71) Applicant: **Yun yun AI Baby camera Co., Ltd.**,  
Taipei (TW)

CN 305820945 \* 6/2020  
KR 300933172.0000 \* 11/2017

(Continued)

(72) Inventors: **Chih-Hsin Tseng**, Taipei (TW);  
**Shih-Yun Shen**, Taipei (TW); **Hsin-Yi Lin**,  
Taipei (TW); **Kang-Ning Shan**, Taipei (TW);  
**Hsueh-Fa Hsu**, Taipei (TW); **Por-Sau Lin**,  
Taipei (TW); **Chien-Yu Chen**, Taipei (TW);  
**Tzu-Ling Liang**, Taipei (TW); **Huan-Yun Wu**,  
Taipei (TW); **Yu-Chiao Wang**, Taipei (TW);  
**Chien-Hui Hsu**, Taipei (TW)

OTHER PUBLICATIONS

Youtube Now That I'm a Mother, "Room Transitioning and Sleep Training with Cubo Ai Baby Monitor" posted Oct. 29, 2019, [online]. [site visited Jul. 28, 2022] Available from Internet, <URL: <https://youtu.be/ziINArCldB0> > (Year: 2019).\*

(Continued)

(73) Assignee: **YUN YUN AI BABY CAMERA CO., LTD.**,  
Taipei (TW)

*Primary Examiner* — Sanjeev Paul

*Assistant Examiner* — Breana Copeland

(74) *Attorney, Agent, or Firm* — Muncy, Geissler, Olds & Lowe, P.C.

(\*\*) Term: **15 Years**

(21) Appl. No.: **29/767,033**

(57) **CLAIM**

(22) Filed: **Jan. 20, 2021**

The ornamental design for a camera, as shown and described.

(51) **LOC (14) Cl.** ..... **16-01**

(52) **U.S. Cl.**

USPC ..... **D16/201; D16/200; D16/202**

(58) **Field of Classification Search**

USPC ..... D16/200, 201, 202, 203, 214, 215, 219;  
D14/203.1, 238.1, 239; D10/104.1,  
D10/106.6, 106.9, 109.1, 119.4;  
D21/350, 606, 608, 609, 626; D22/132,  
D22/146

CPC ..... G03B 2217/00; G03B 2217/002; G03B  
17/16; G03B 17/56

See application file for complete search history.

**DESCRIPTION**

FIG. 1 is a perspective view of a camera showing our new design;  
FIG. 2 is another perspective view thereof;  
FIG. 3 is a front view thereof;  
FIG. 4 is a rear view thereof;  
FIG. 5 is a left view thereof;  
FIG. 6 is a right view thereof;  
FIG. 7 is a top view thereof;  
FIG. 8 is a bottom view thereof; and,  
FIG. 9 is an operational bottom view thereof, showing a lens rotated to a bottom of the camera.  
The portions of the Figures shown in broken lines are shown for illustrative purposes only and form no part of the claimed design.

(56) **References Cited**

U.S. PATENT DOCUMENTS

D672,935 S \* 12/2012 Khan ..... D99/5  
D813,926 S \* 3/2018 Shin ..... D16/203  
D822,742 S \* 7/2018 Hathway ..... D16/202

(Continued)

**1 Claim, 9 Drawing Sheets**

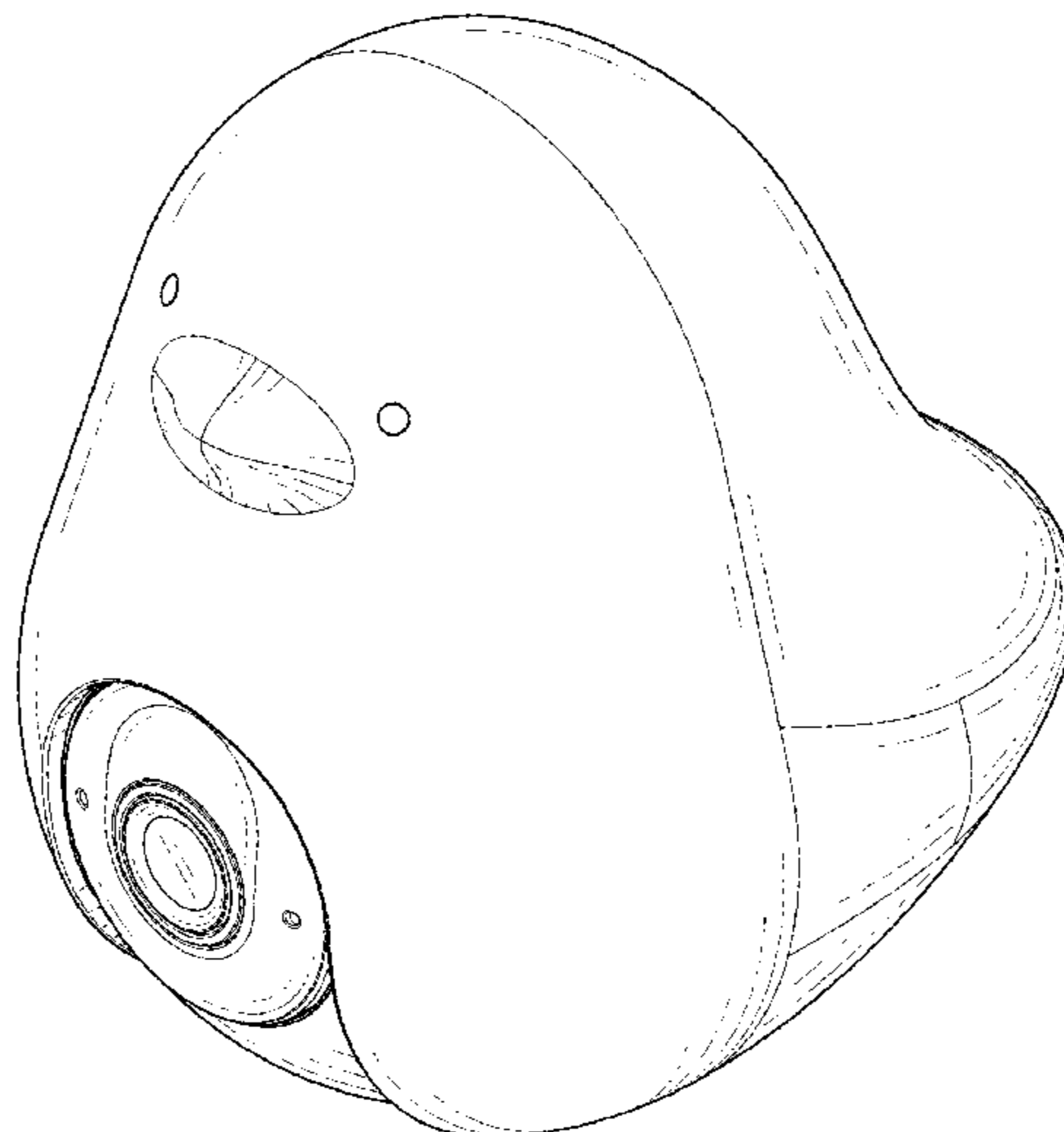

(56)

**References Cited**

U.S. PATENT DOCUMENTS

D864,276	S	*	10/2019	Hathway .....	D16/203
D867,425	S	*	11/2019	Shuai .....	D16/203
D883,357	S	*	5/2020	Moon .....	D16/203
D890,831	S	*	7/2020	Zheng .....	D16/203
D944,769	S	*	3/2022	Bae .....	D14/207
D955,461	S	*	6/2022	Miyagawa .....	D16/218

FOREIGN PATENT DOCUMENTS

KR	301151976.0000	*	2/2022
TW	209550-0001	*	1/2021

OTHER PUBLICATIONS

Instagram Cubobabymonitor, CuboAI Smart Baby Monitor, posted May 1, 2019, [online], [site visited Jul. 28, 2022] Available from Internet, <URL: [https://www.instagram.com/p/Bw8OQx4pl\\_c/?igshid=MDJmNzVkMjY](https://www.instagram.com/p/Bw8OQx4pl_c/?igshid=MDJmNzVkMjY)> (Year: 2019).\*

Reviewed, "These Are the Best Parenting and Kids Products of 2020", published Nov. 4, 2020 [online], [site visited Jul. 28, 2022] Available from Internet, <URL <https://www.reviewed.com/parenting/features/revieweds-2020-best-year-parenting-kids> > (Year: 2020).\*

Google Image Search, Tilt and Pan Security Camera, [online], [site visited Jul. 22, 2022] Available from Internet, <URL: <https://www.google.com/search?q=tilt+and+pan+security+camera&tbm=isch&ved=2ahUKEwj80q6rll35AhW0n3IEHXInAP0Q2-cCegQIABAA&oq=tilt+%E2%80%A6>> (Year: 2022).\*

\* cited by examiner

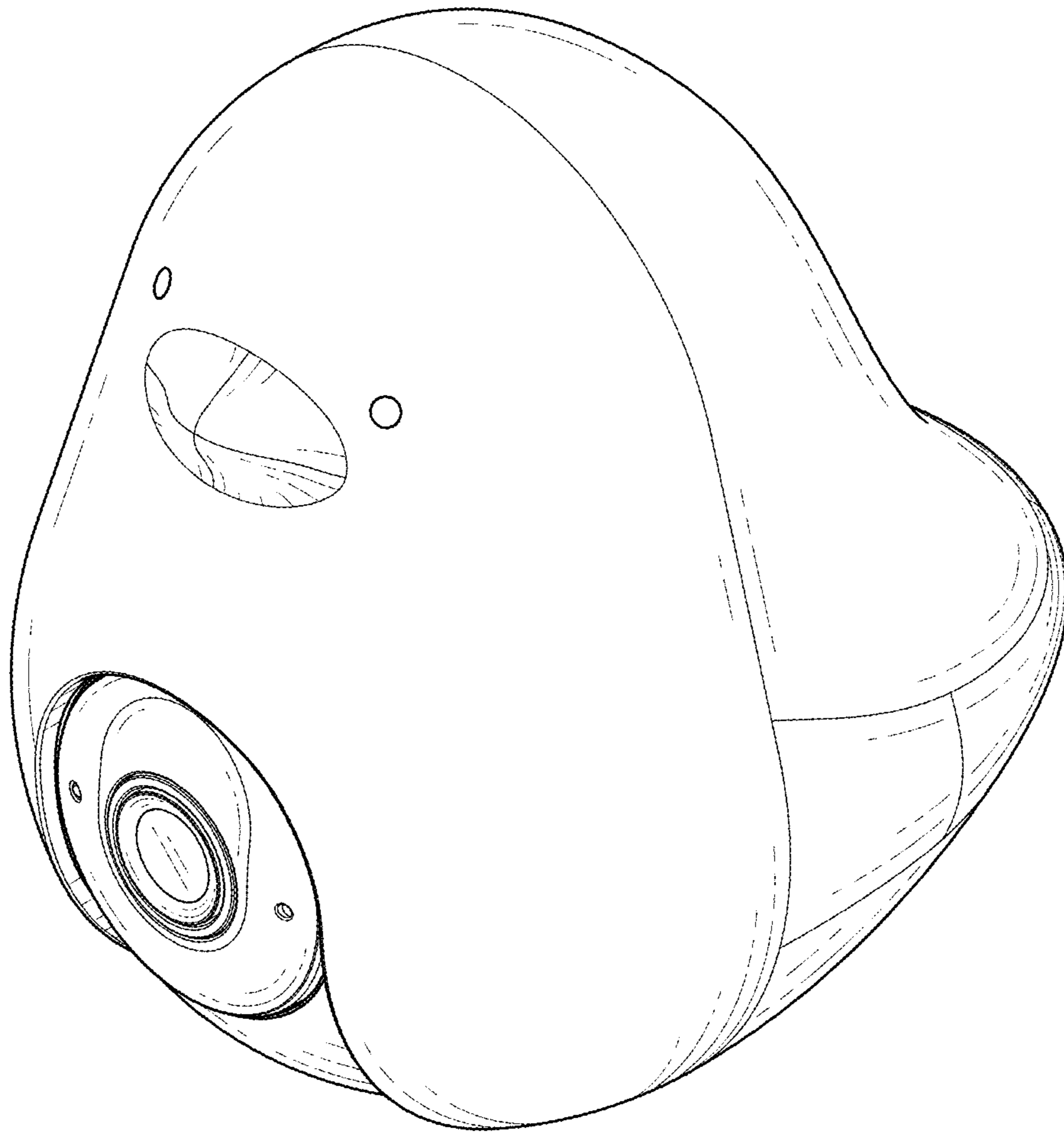

FIG. 1

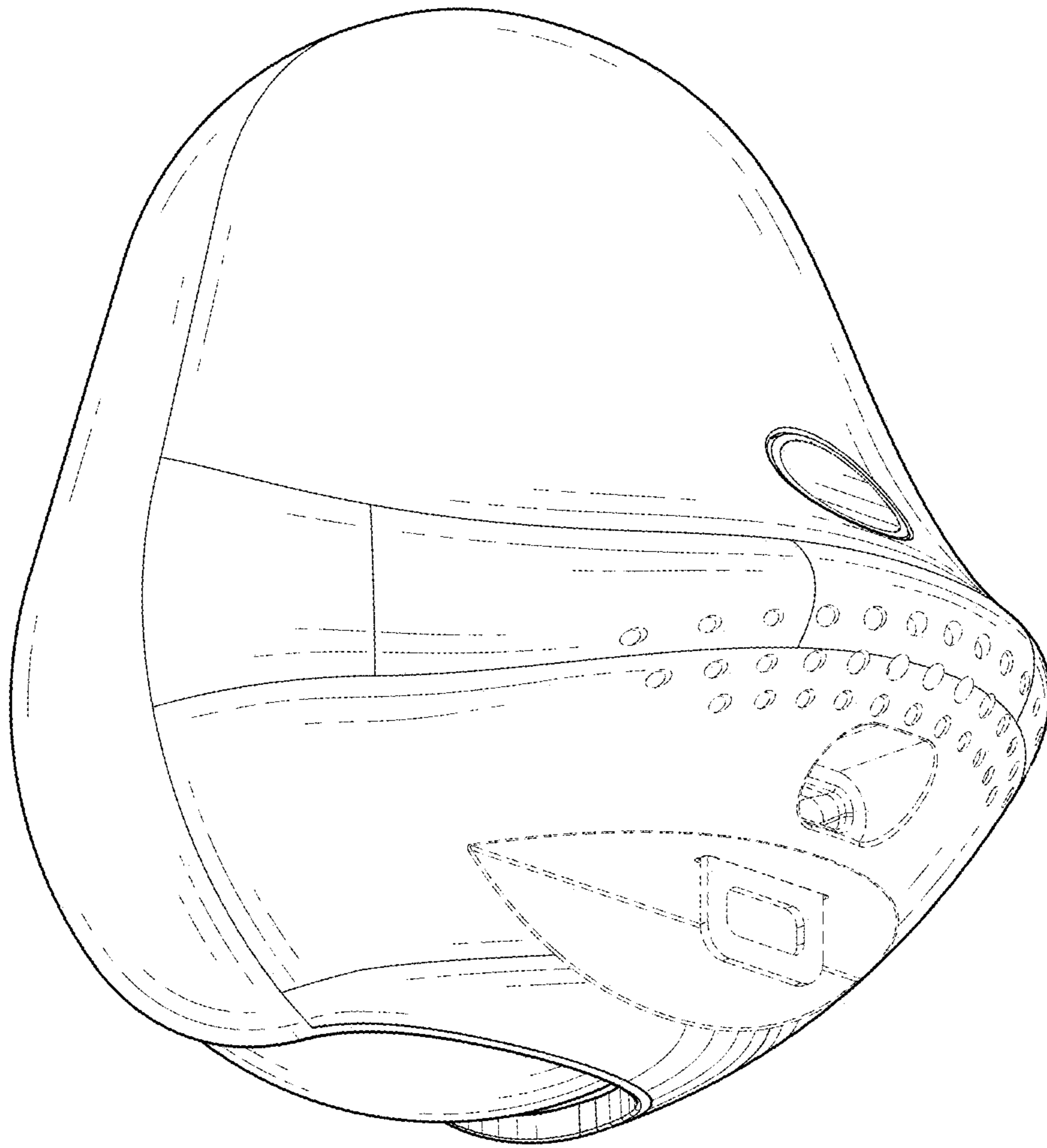

FIG. 2

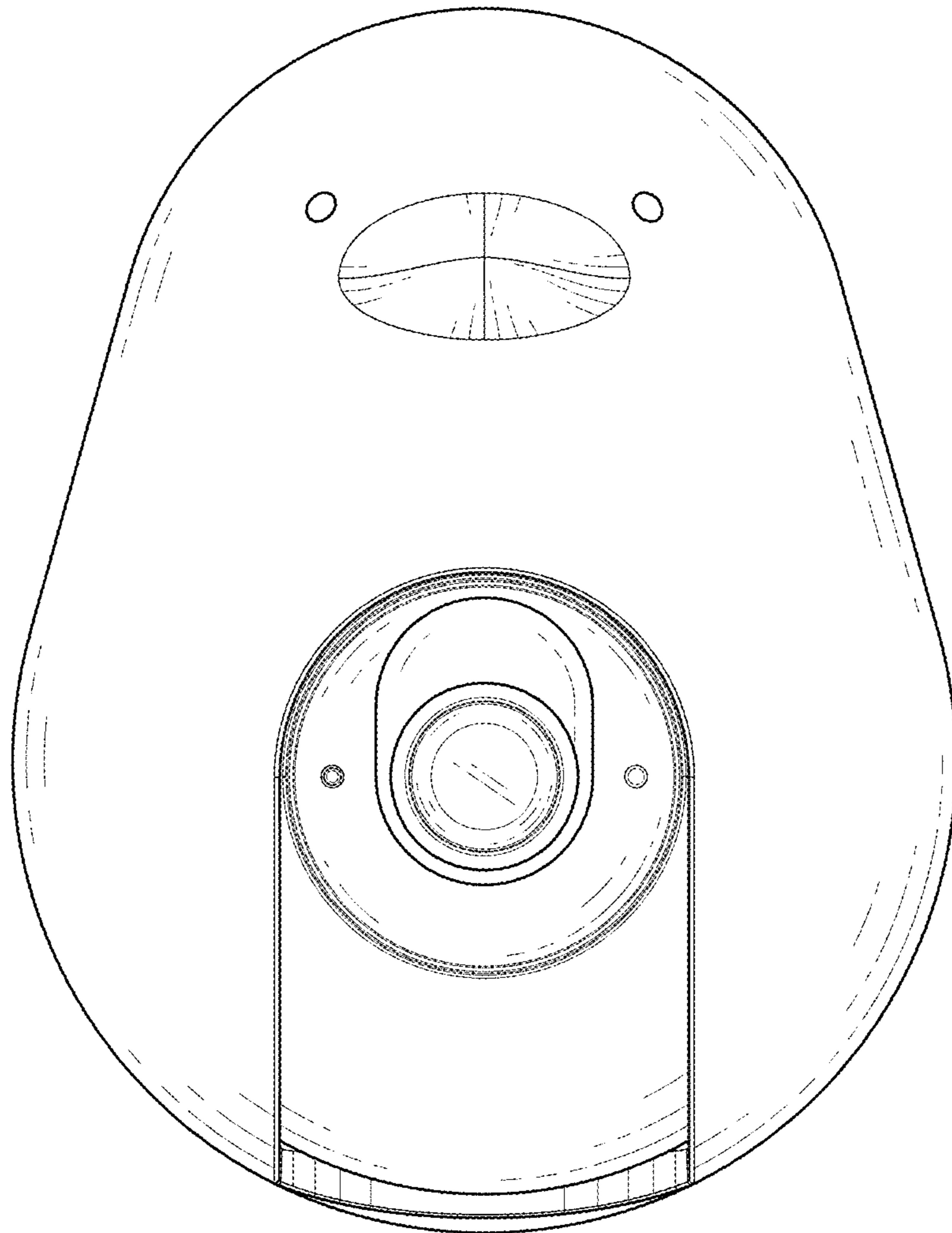

FIG. 3

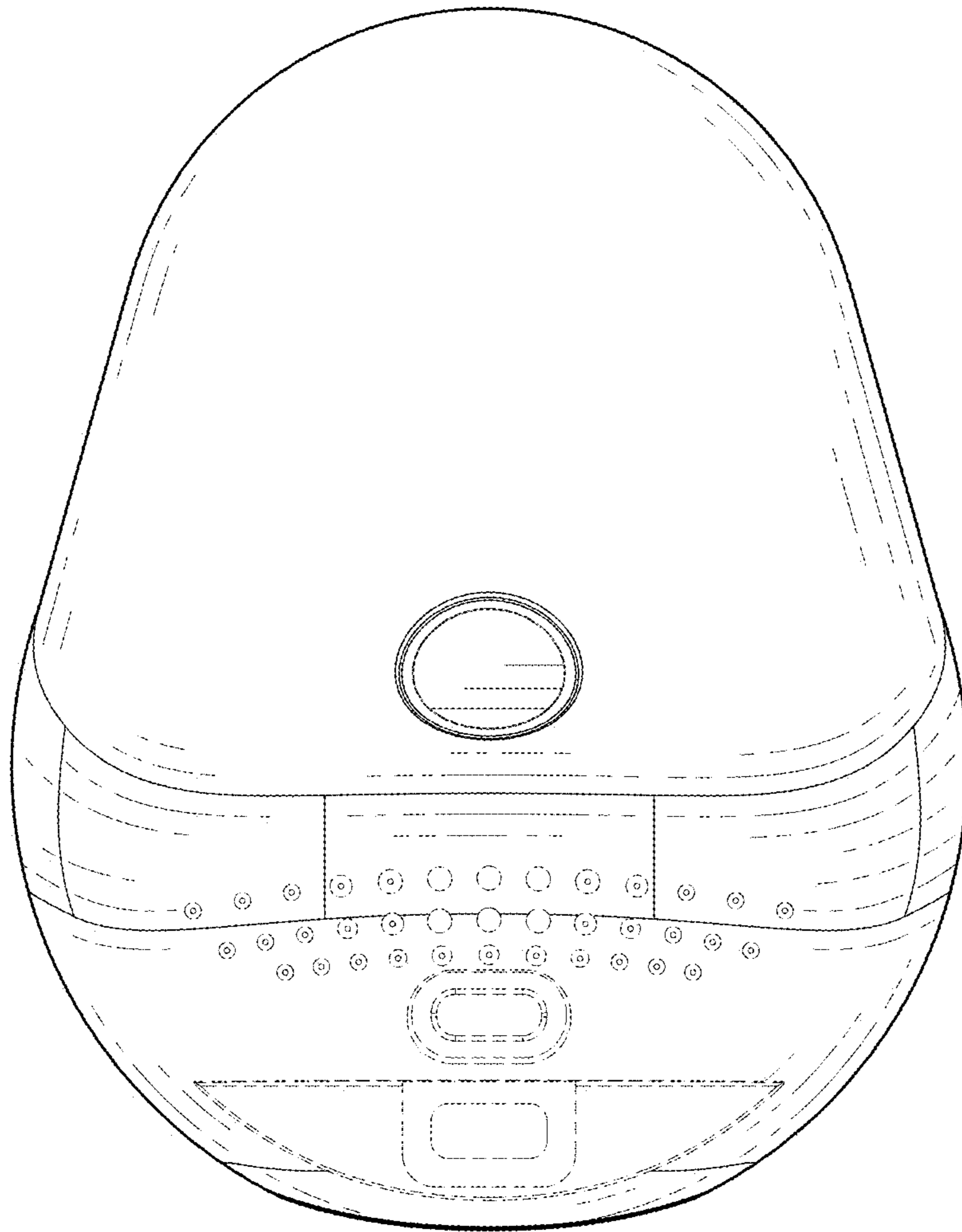

FIG. 4

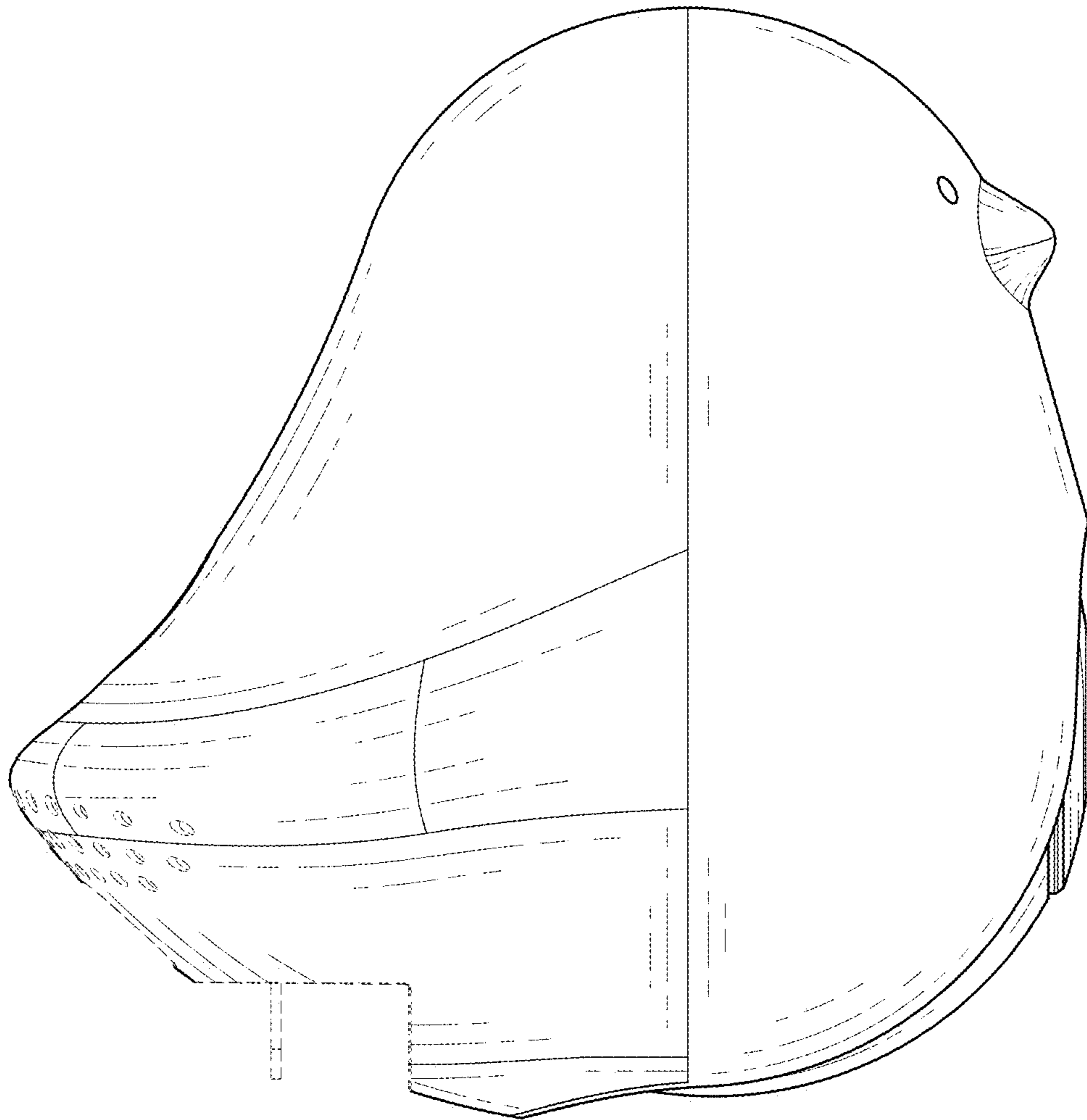

FIG. 5

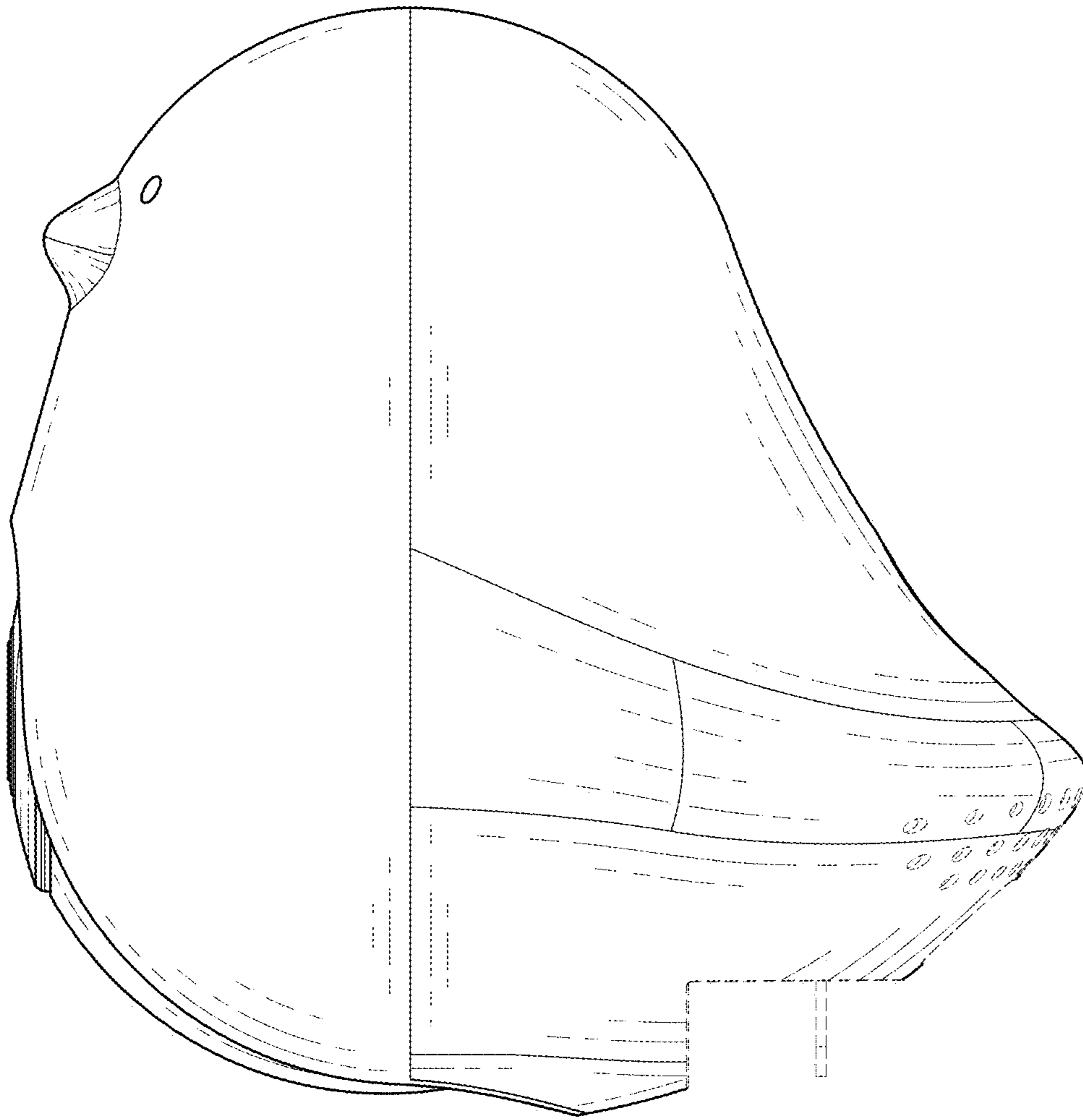

FIG. 6



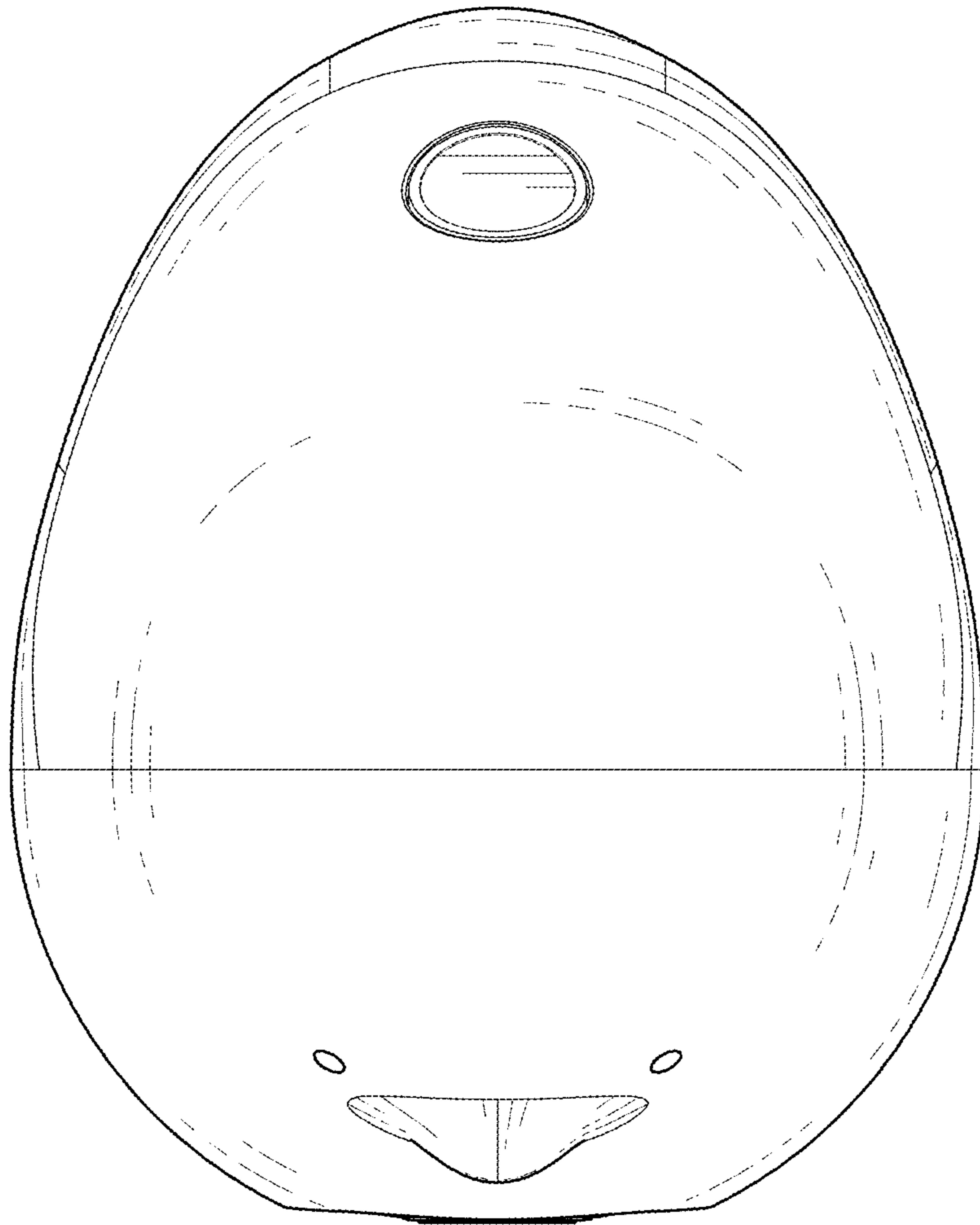

FIG. 7

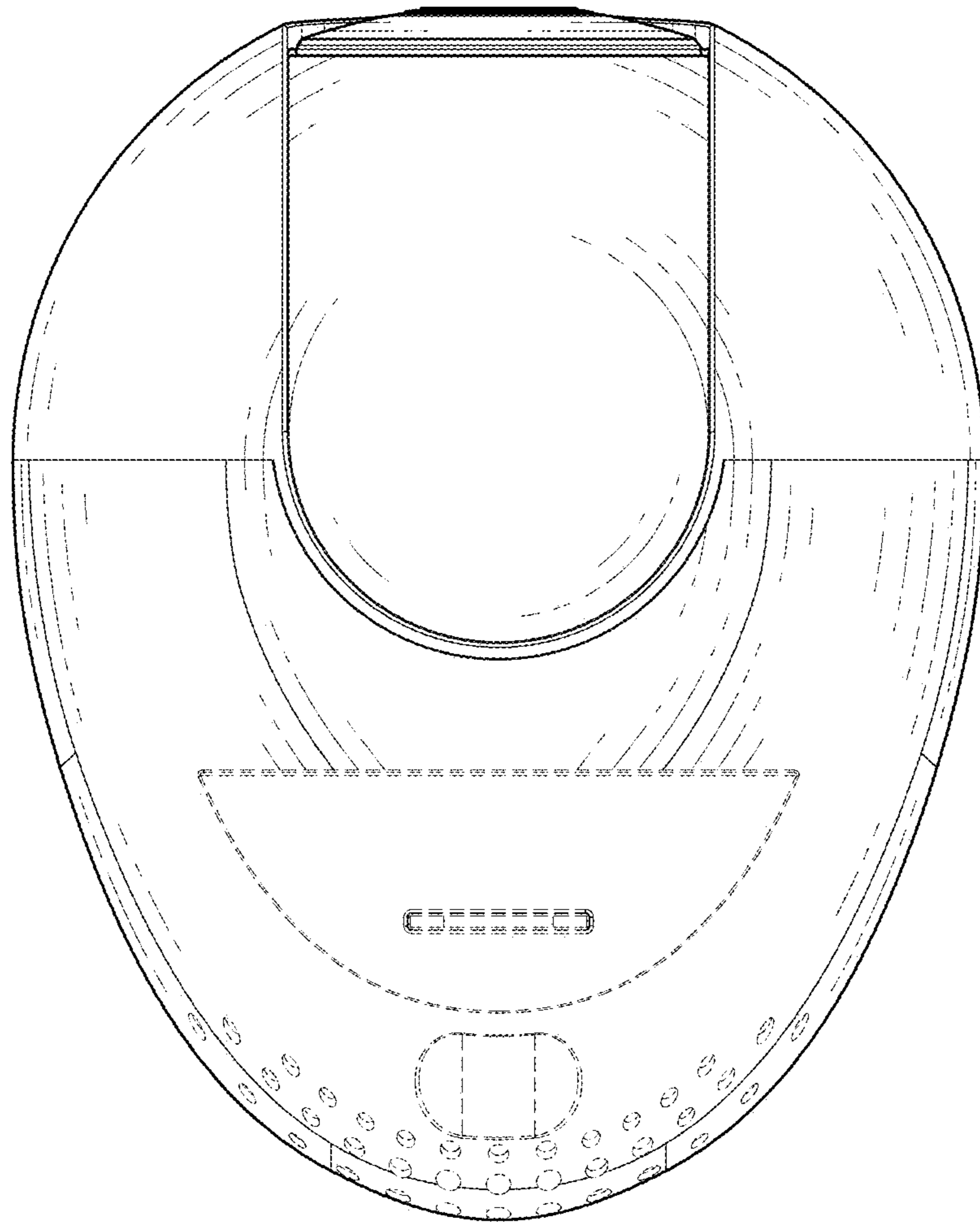

FIG. 8

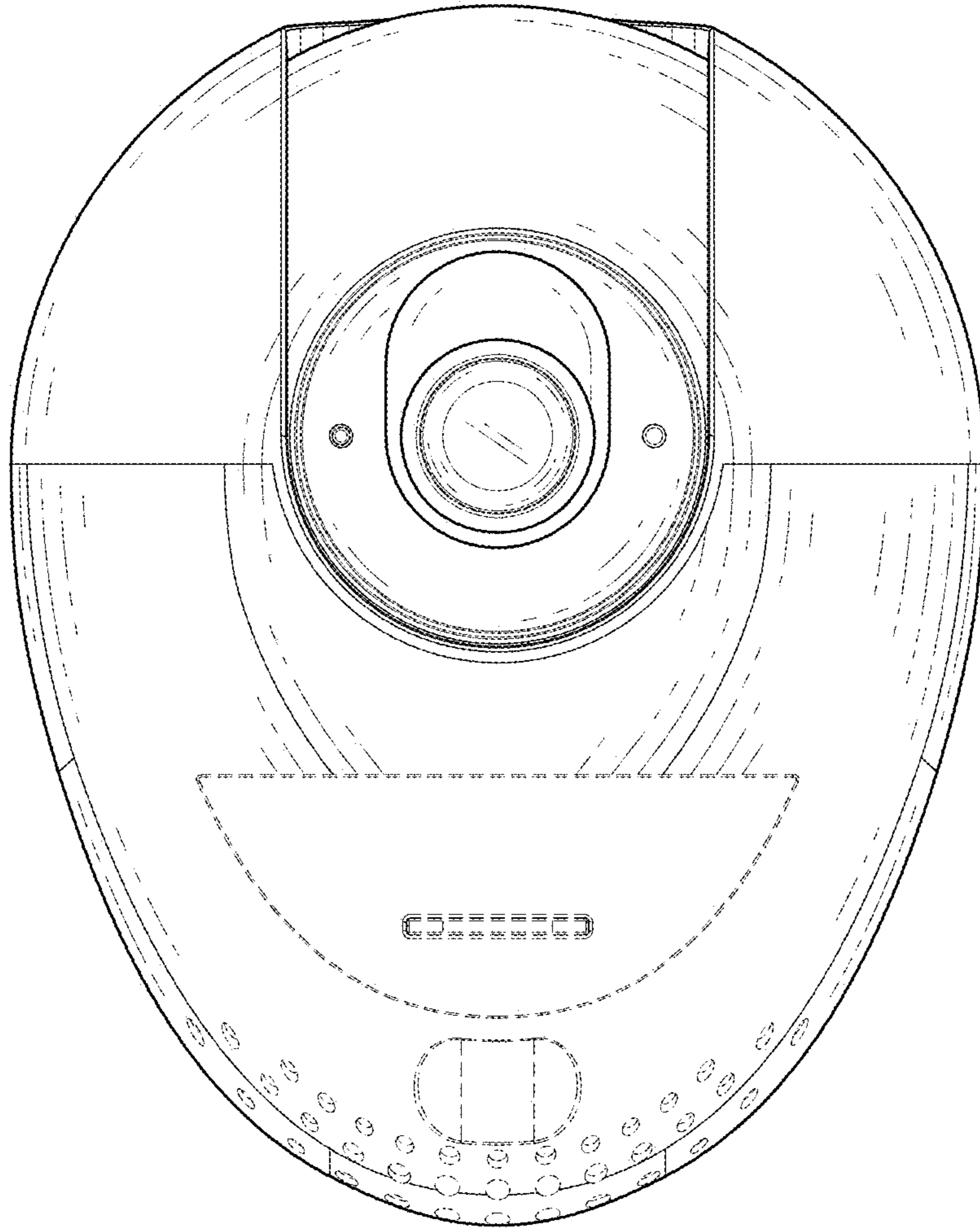

FIG. 9