



US00D982034S

(12) **United States Design Patent**
Sigmon et al.

(10) **Patent No.:** **US D982,034 S**

(45) **Date of Patent:** **** Mar. 28, 2023**

(54) **DISPLAY SCREEN OR PORTION THEREOF WITH ANIMATED GRAPHICAL USER INTERFACE**

(71) Applicant: **Dropbox, Inc.**, San Francisco, CA (US)

(72) Inventors: **Ian Sigmon**, Bloomfield Hills, MI (US); **John Hughes**, Birmingham, MI (US); **Jordan Scott**, Ferndale, MI (US); **Issey Roquet**, Toronto (CA)

(73) Assignee: **Dropbox, Inc.**, San Francisco, CA (US)

(**) Term: **15 Years**

(21) Appl. No.: **29/801,588**

(22) Filed: **Jul. 29, 2021**

(51) **LOC (14) Cl.** **14-04**

(52) **U.S. Cl.**
USPC **D14/488**

(58) **Field of Classification Search**
USPC D14/485-95
CPC G06F 3/048; G06F 3/0481; G06F 3/04812; G06F 3/04815; G06F 3/04817; G06F 3/0482; G06F 3/0483; G06F 3/0484; G06F 3/04842; G06F 3/04845; G06F 3/04847; G06F 3/0485; G06F 3/0486; G06F 3/0487;

(Continued)

(56) **References Cited**

U.S. PATENT DOCUMENTS

3,310,221 A * 3/1967 Duncan B65D 5/0281
229/117.17

D385,868 S * 11/1997 Fumarolo D14/489
(Continued)

OTHER PUBLICATIONS

GIF Box Icon—Geyer, <https://dribbble.com/shots/1266888--GIF-Box-Icon#> (Year: 2013).*

(Continued)

Primary Examiner — Melanie H Tung
Assistant Examiner — Darmawan Truong
(74) *Attorney, Agent, or Firm* — Sterne, Kessler, Goldstein & Fox P.L.L.C.

(57) **CLAIM**

The ornamental design for a display screen or portion thereof with animated graphical user interface, as shown and described.

DESCRIPTION

The file of this patent contains at least one drawing/photograph executed in color. Copies of this patent with color drawing(s)/photograph(s) will be provided by the Office upon request and payment of the necessary fee.

FIG. 1 is a front view of a display screen or portion thereof with animated graphical user interface showing a first image of the claimed design;

FIG. 2 is a second image thereof;

FIG. 3 is a third image thereof;

FIG. 4 is a fourth image thereof

FIG. 5 is a fifth image thereof;

FIG. 6 is a sixth image thereof;

FIG. 7 is another embodiment of a display screen or portion thereof with animated graphical user interface showing a first image of the claimed design;

FIG. 8 is a second image thereof;

FIG. 9 is a third image thereof;

FIG. 10 is a fourth image thereof;

FIG. 11 is a fifth image thereof; and,

FIG. 12 is a sixth image thereof.

The broken lines in the figures show a display screen or portion thereof, and form no part of the claimed design.

The appearance of the animated image sequentially transitions between the images shown in FIGS. 1-6 and FIGS. 7-12. The process or period in which one image transitions to another forms no part of the claimed design.

1 Claim, 12 Drawing Sheets
(6 of 12 Drawing Sheet(s) Filed in Color)

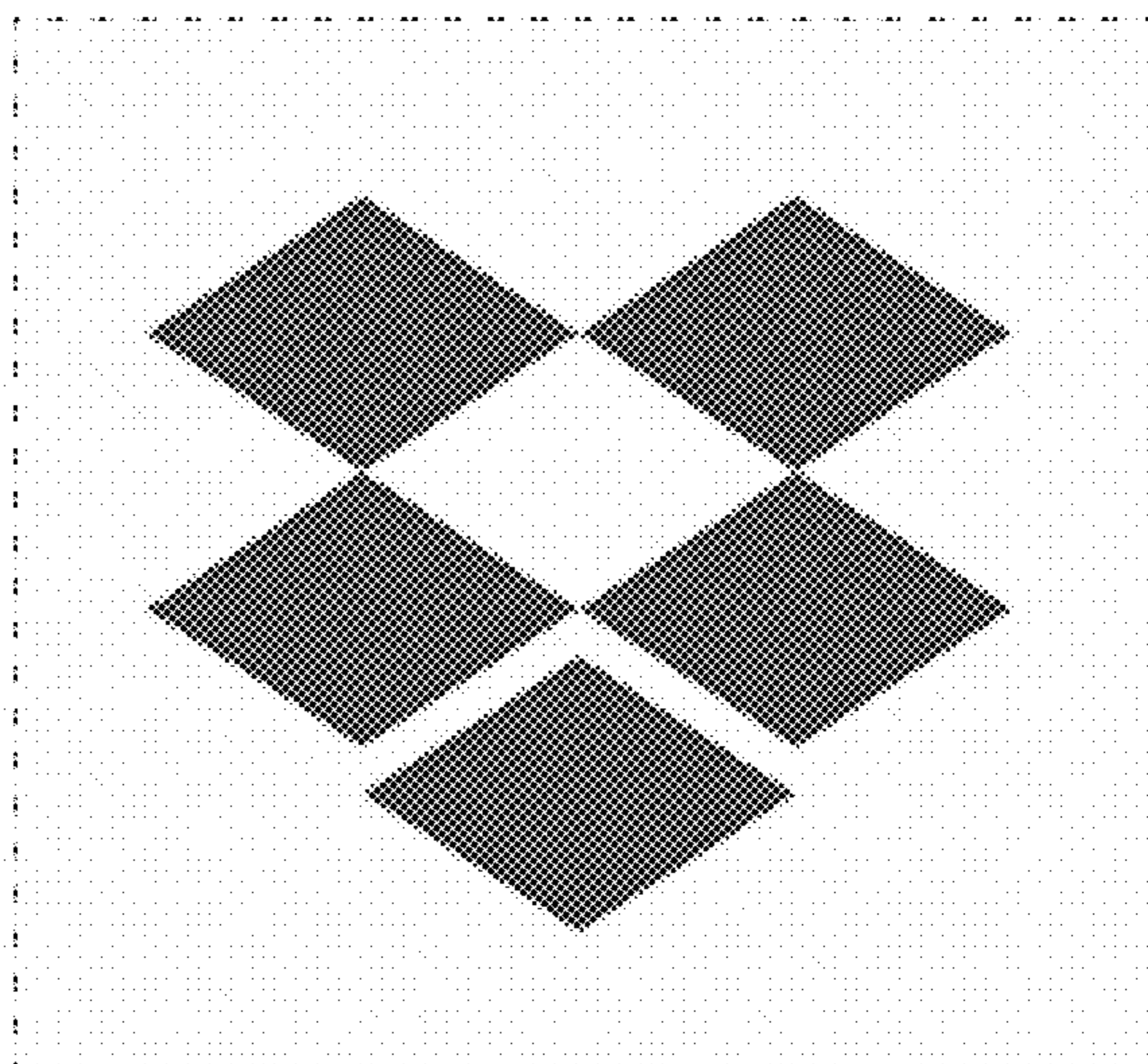
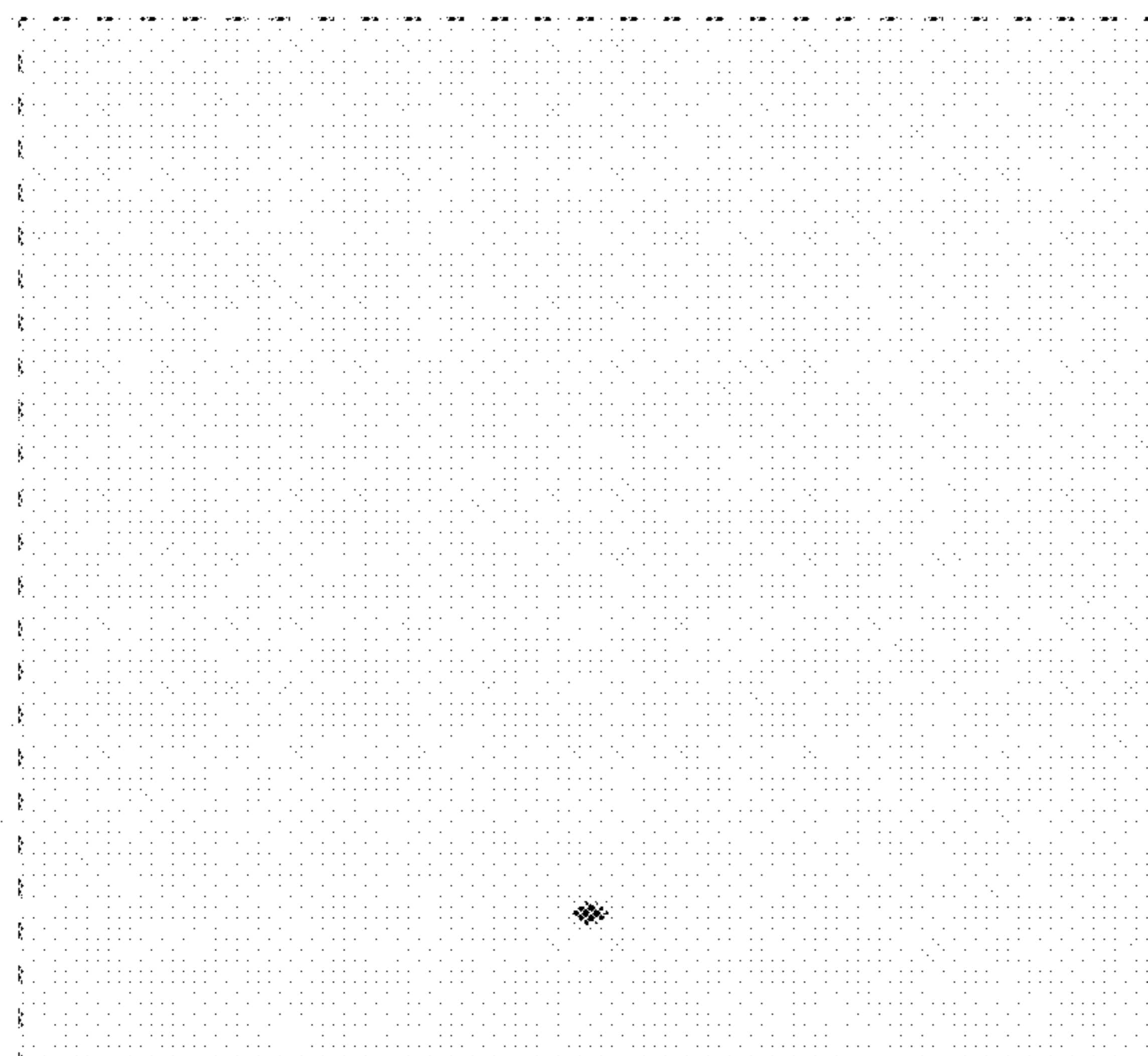

(58) **Field of Classification Search**
 CPC G06F 3/0488; G06F 3/04883; G06F
 3/04886
 See application file for complete search history.

(56) **References Cited**

U.S. PATENT DOCUMENTS

D525,631	S	*	7/2006	Kaminaga	D14/489
D574,847	S	*	8/2008	O'Donnell	D14/492
D593,121	S	*	5/2009	Danton	D14/489
D593,125	S	*	5/2009	Danton	D14/489
7,538,764	B2	*	5/2009	Salomie G06T 17/20 380/232	
D602,027	S	*	10/2009	Queric	D14/485
D623,657	S	*	9/2010	Fitzmaurice	D14/488
D627,789	S	*	11/2010	Jewitt	D14/485
D628,586	S	*	12/2010	Umezawa	D14/492
D629,420	S	*	12/2010	O'Donnell	D14/492
D670,310	S	*	11/2012	Saito	D14/489
D710,882	S	*	8/2014	Francisco	D14/489
D726,761	S	*	4/2015	Park	D14/489
D732,072	S	*	6/2015	Ying	D14/489
D745,040	S	*	12/2015	Leighton	D14/488
D758,382	S	*	6/2016	Hirai	D14/485

D777,185	S	*	1/2017	Kwak	D14/486
D800,165	S	*	10/2017	Hinze	D14/492
D819,691	S	*	6/2018	Evans	D14/491
D910,067	S	*	2/2021	Kim	D14/489
D946,013	S	*	3/2022	Maiman	D14/485
2006/0020906	A1	*	1/2006	Plut G06F 1/3265 715/867	
2008/0083822	A1	*	4/2008	Benes B65D 5/4608 229/185.1	
2013/0346911	A1	*	12/2013	Sripada G06F 3/04817 715/782	

OTHER PUBLICATIONS

The Dropbox rebrand features a logo update—Brewer, <https://www.itsnicethat.com/news/dropbox-rebrand-collins-graphic-design-041017> (Year: 2017).*

Cardboard Box Icon Set Vector—Vexels, <https://www.vexels.com/vectors/preview/230125/cardboard-box-icon-set> (Year: 2021).*

Dropbox, Inc., U.S. Trademark Serial No. 85945447, filed May 29, 2013, 2 pages.

Dropbox, Inc., U.S. Trademark Serial No. 85945482, filed May 29, 2013, 2 pages.

* cited by examiner

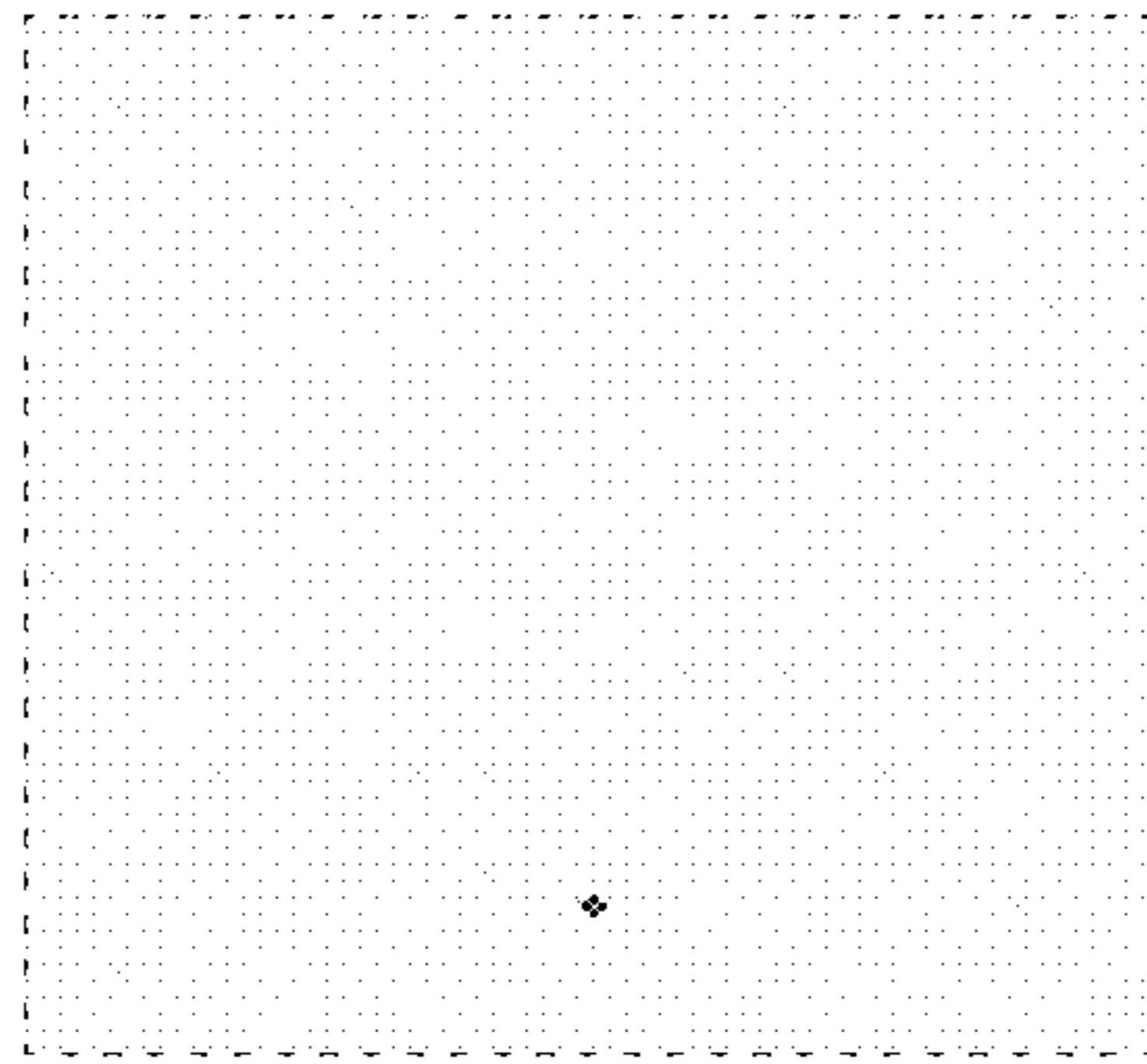

FIG. 1

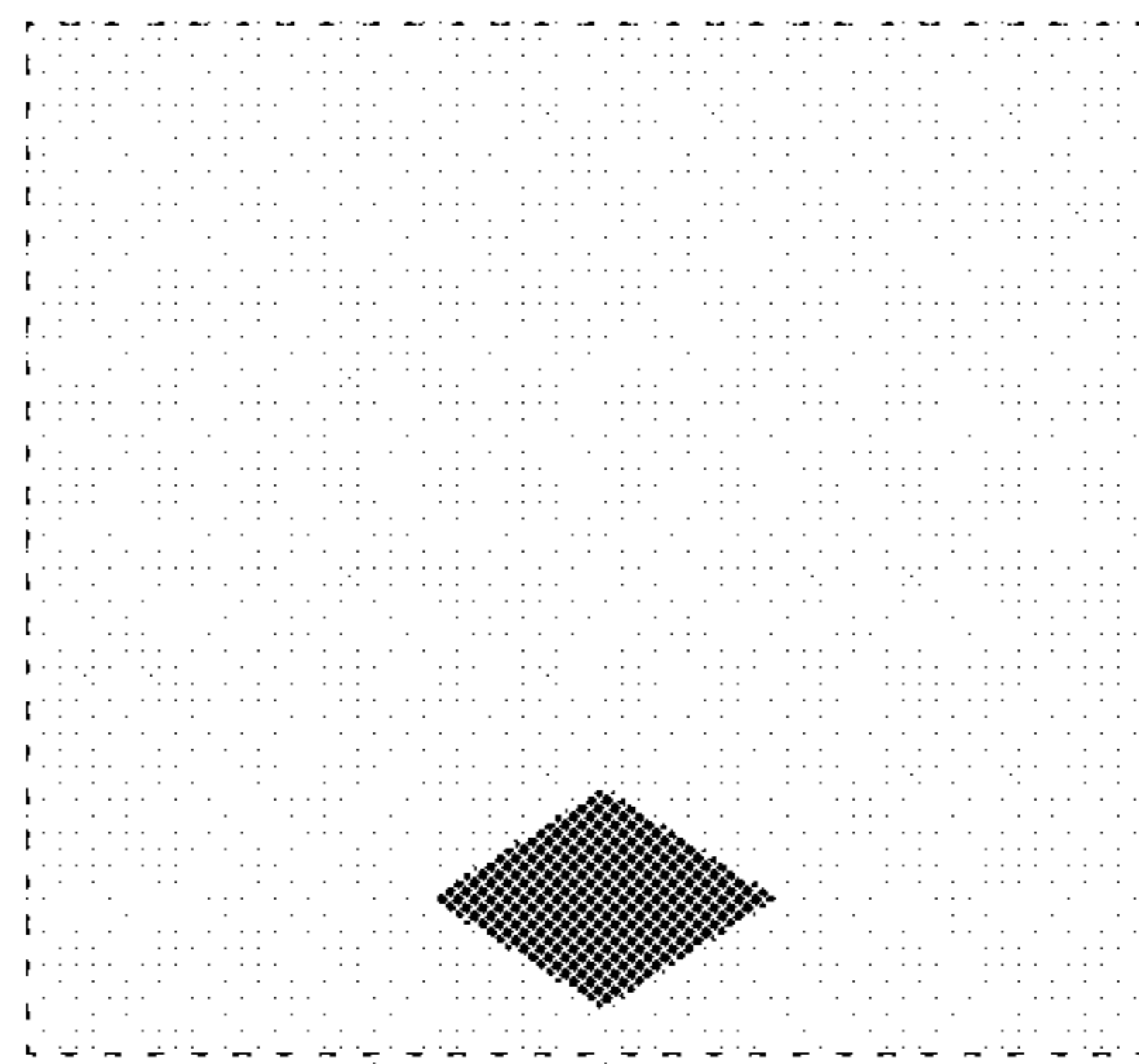

FIG. 2

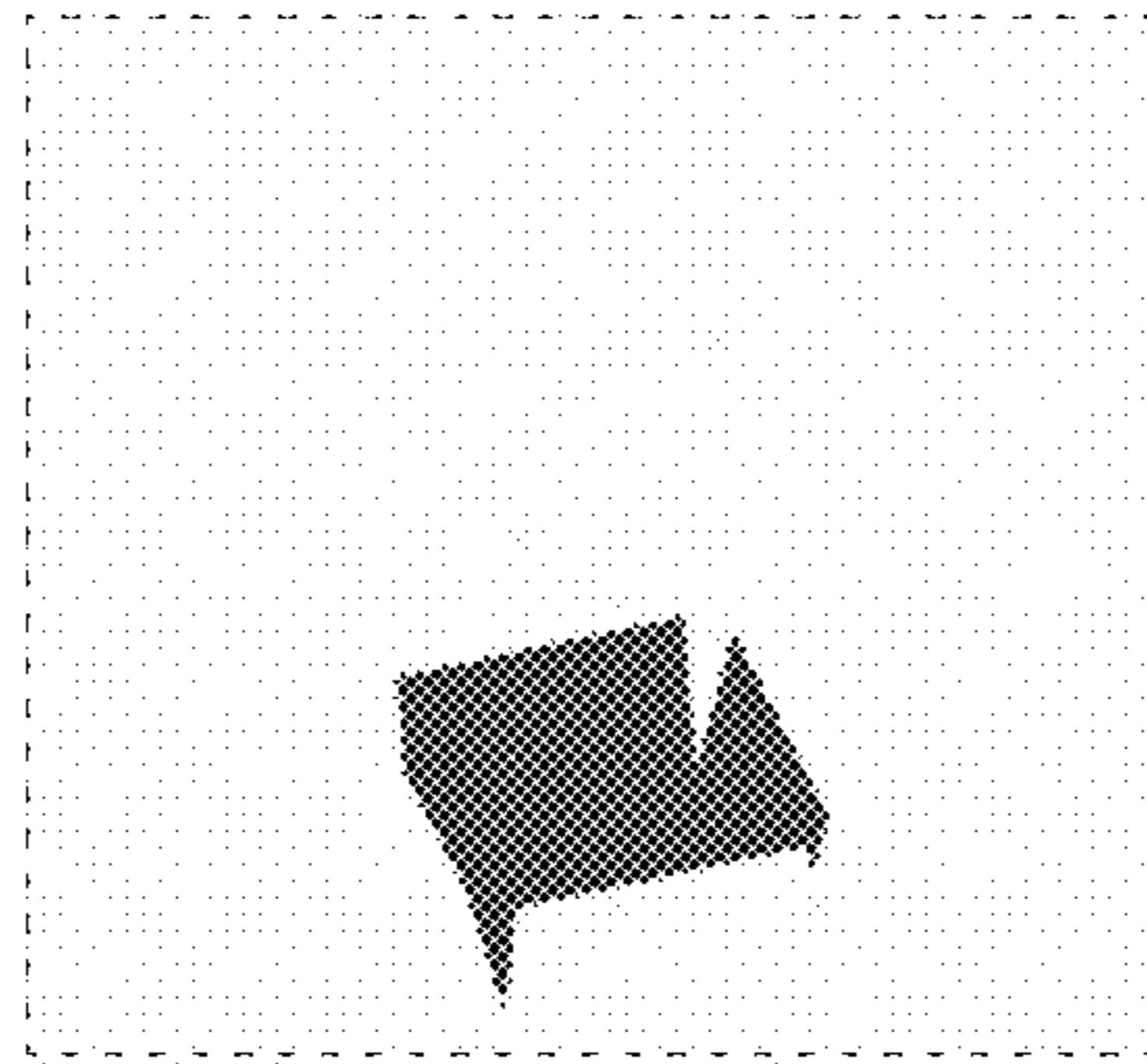

FIG. 3

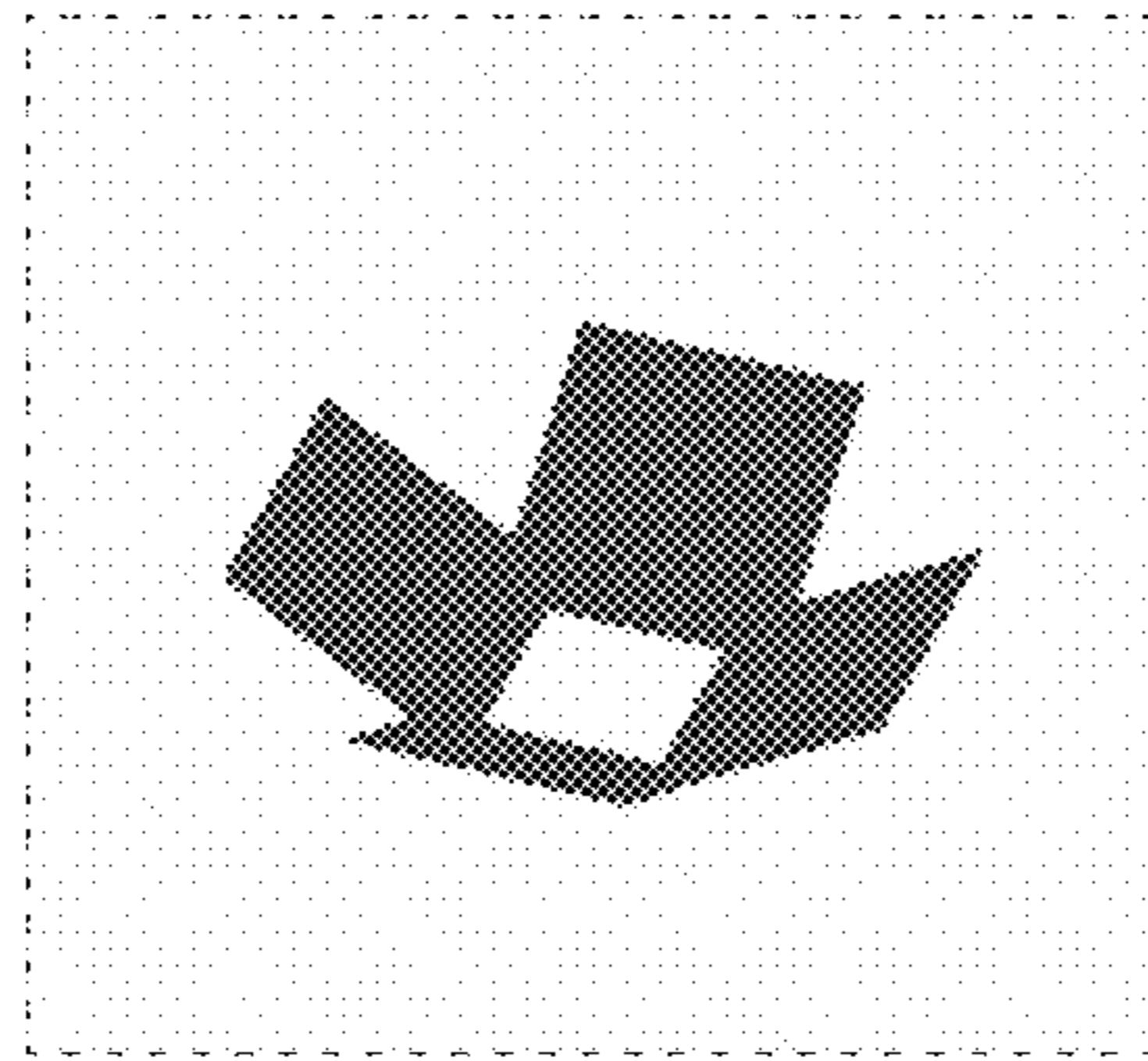

FIG. 4

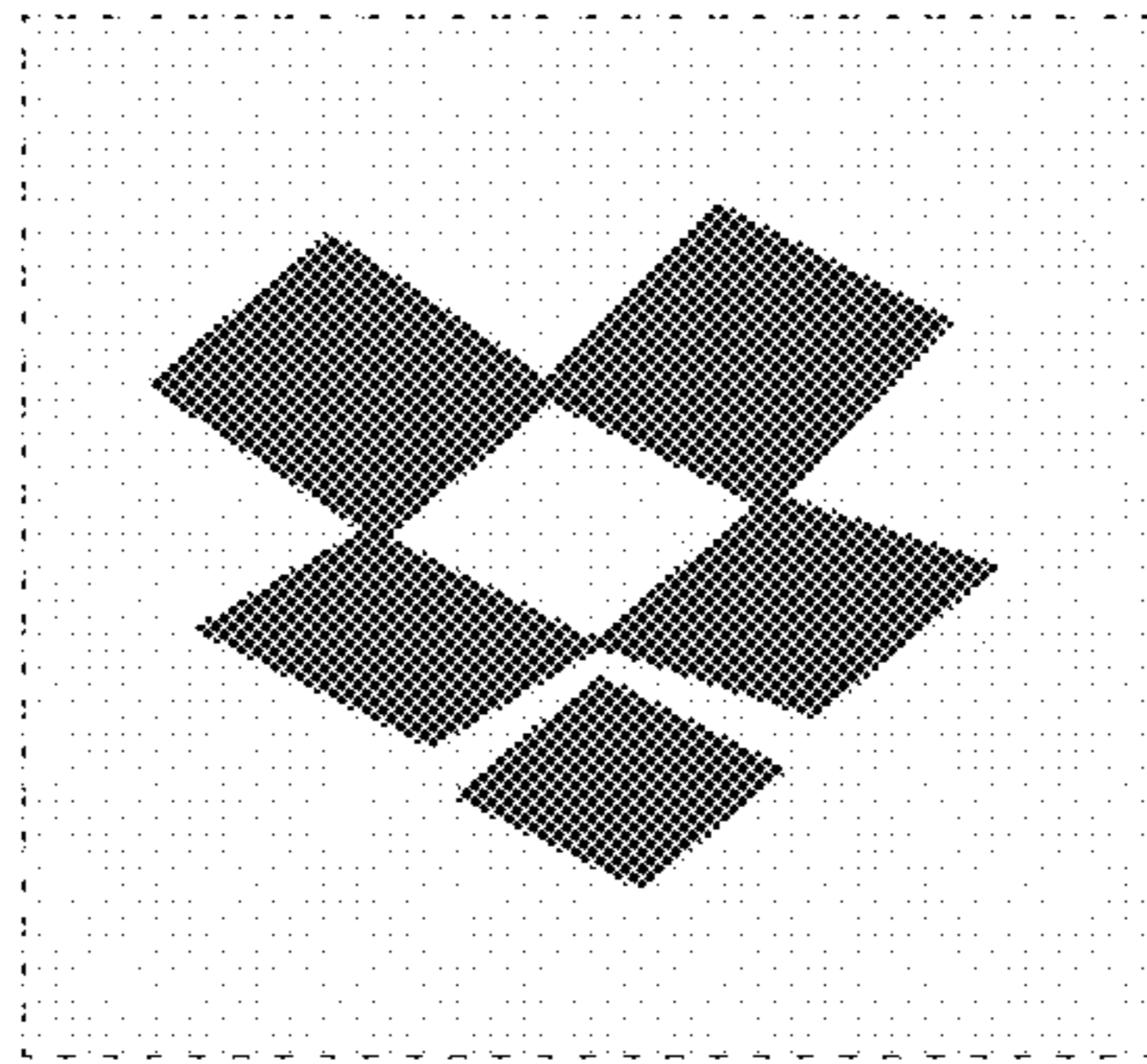

FIG. 5

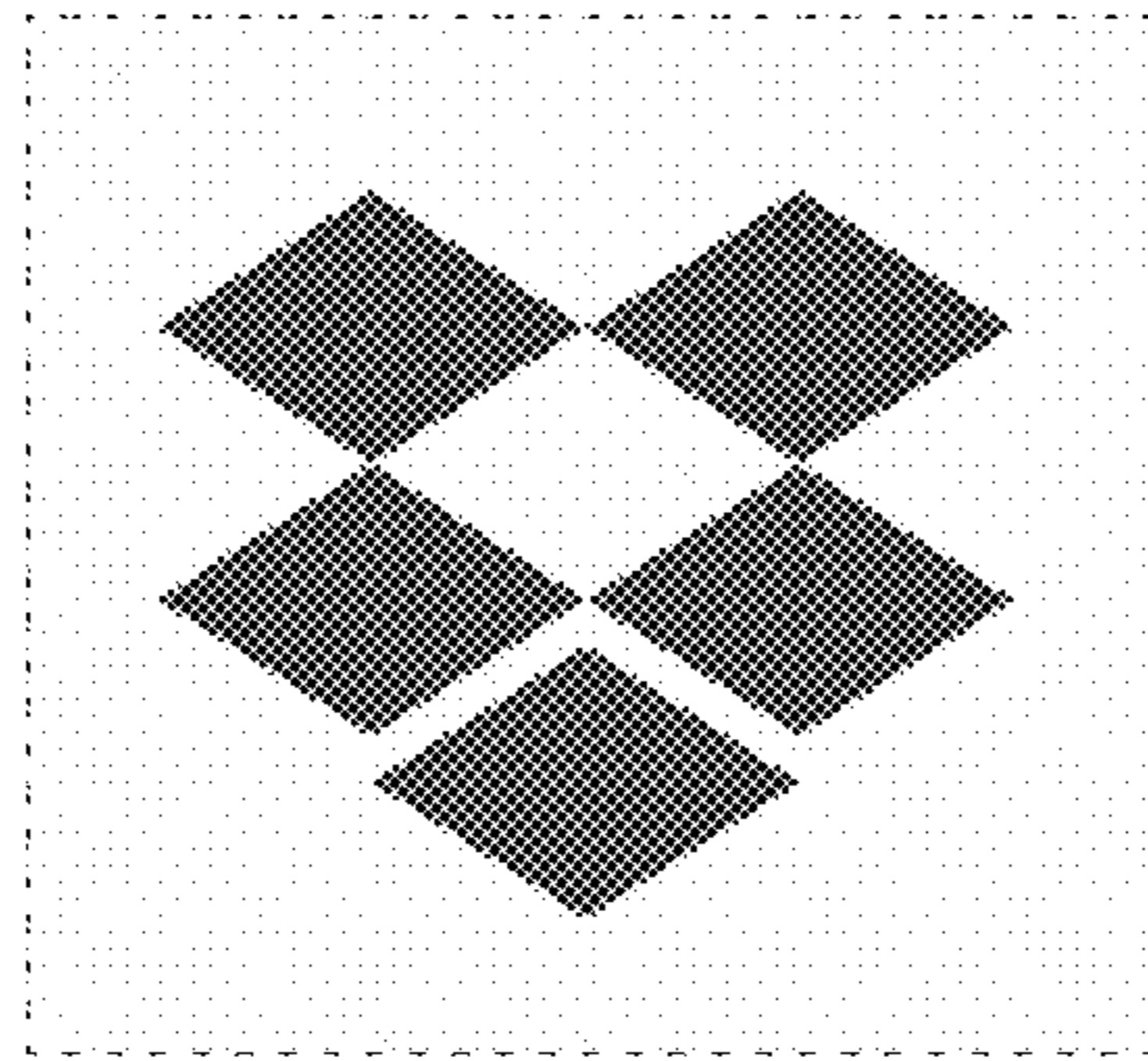

FIG. 6

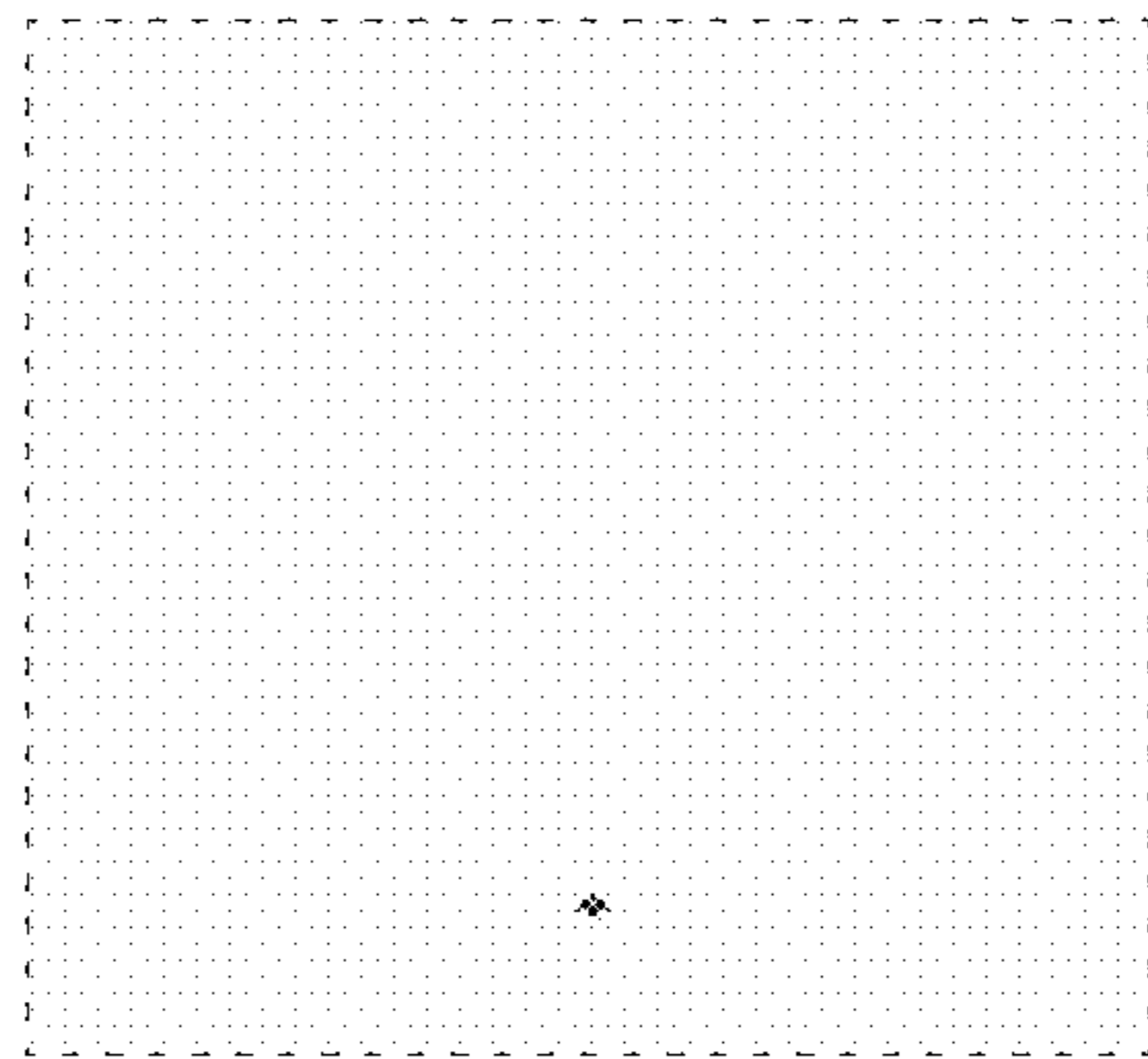

FIG. 7

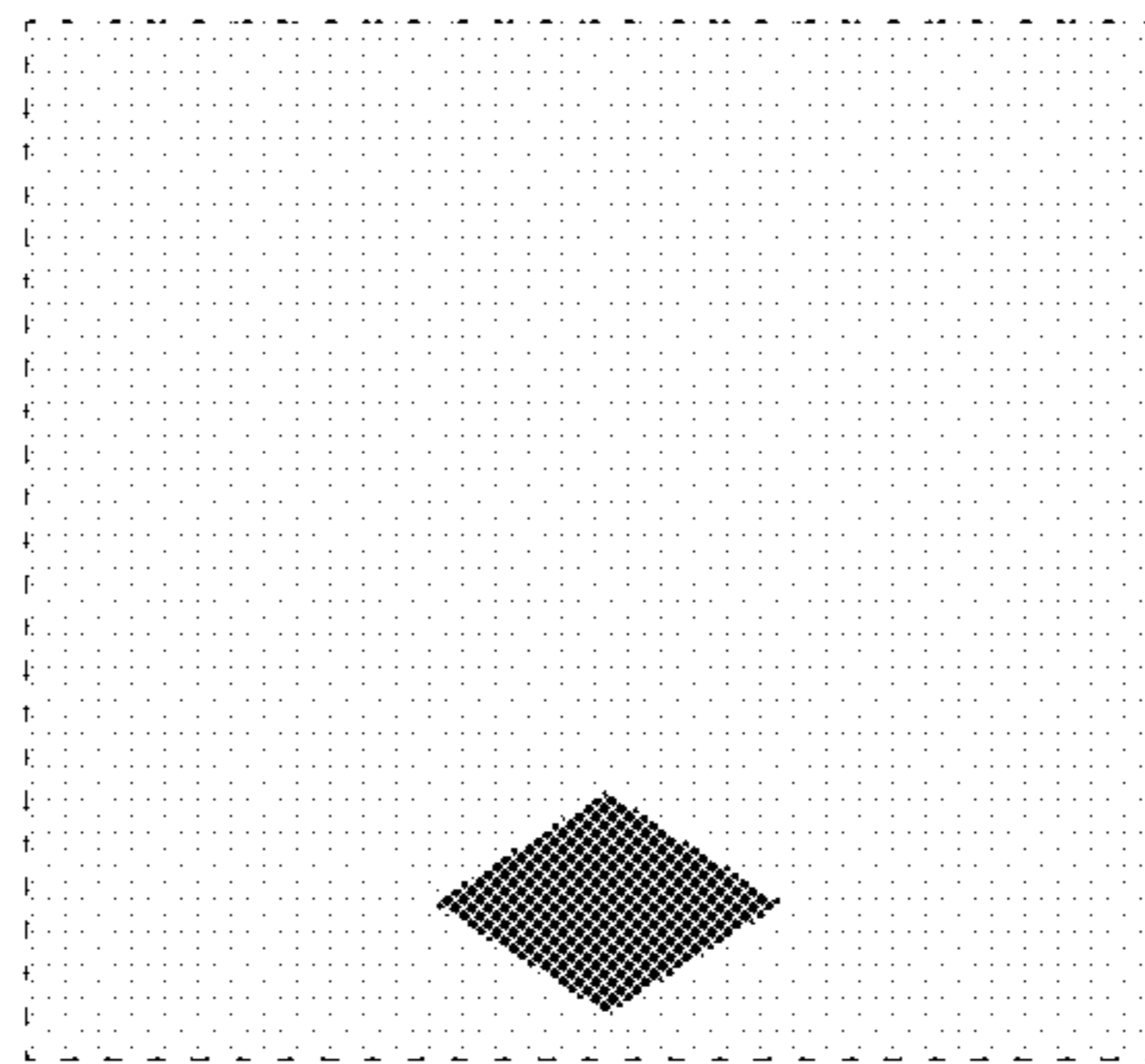

FIG. 8

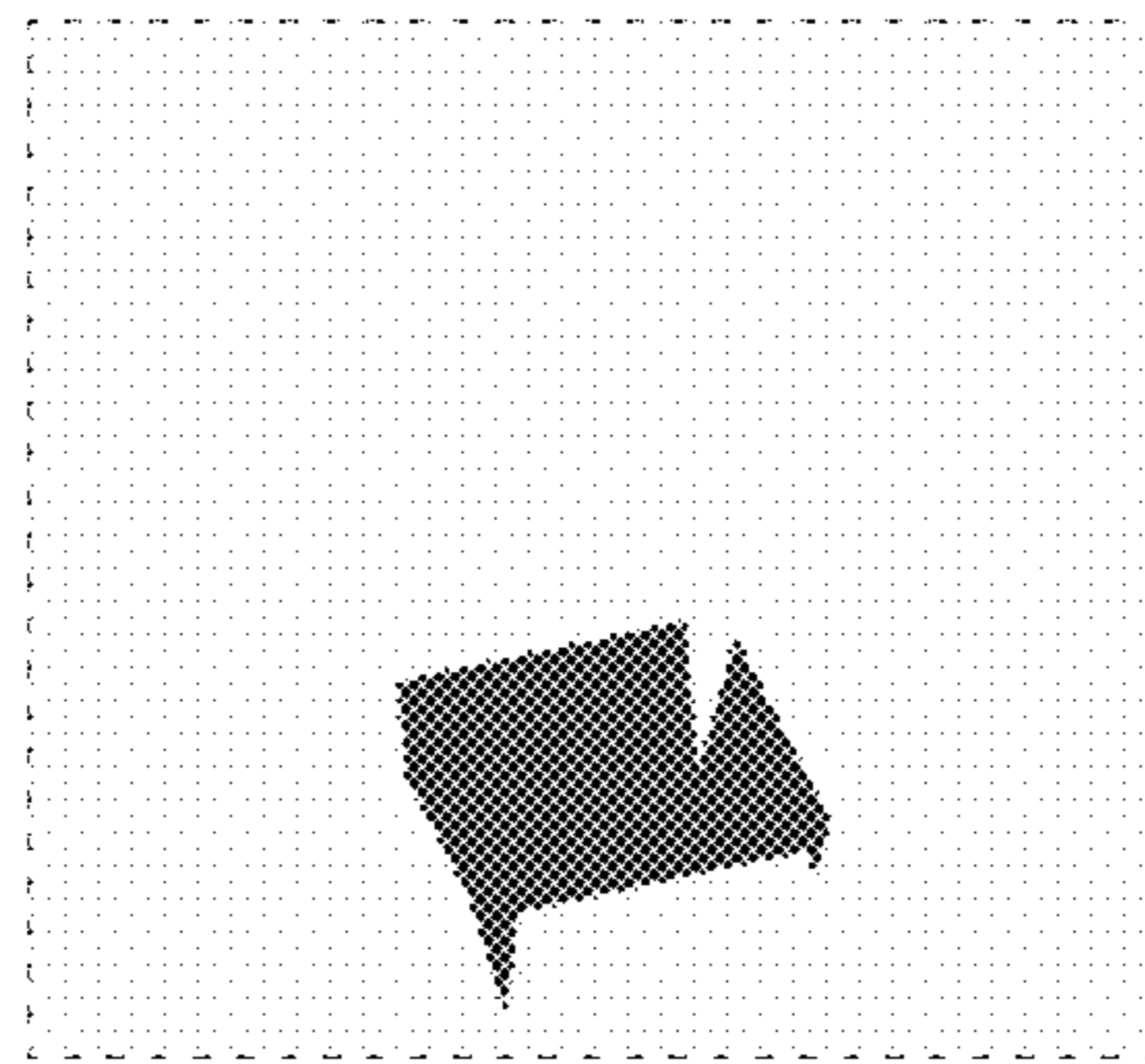

FIG. 9

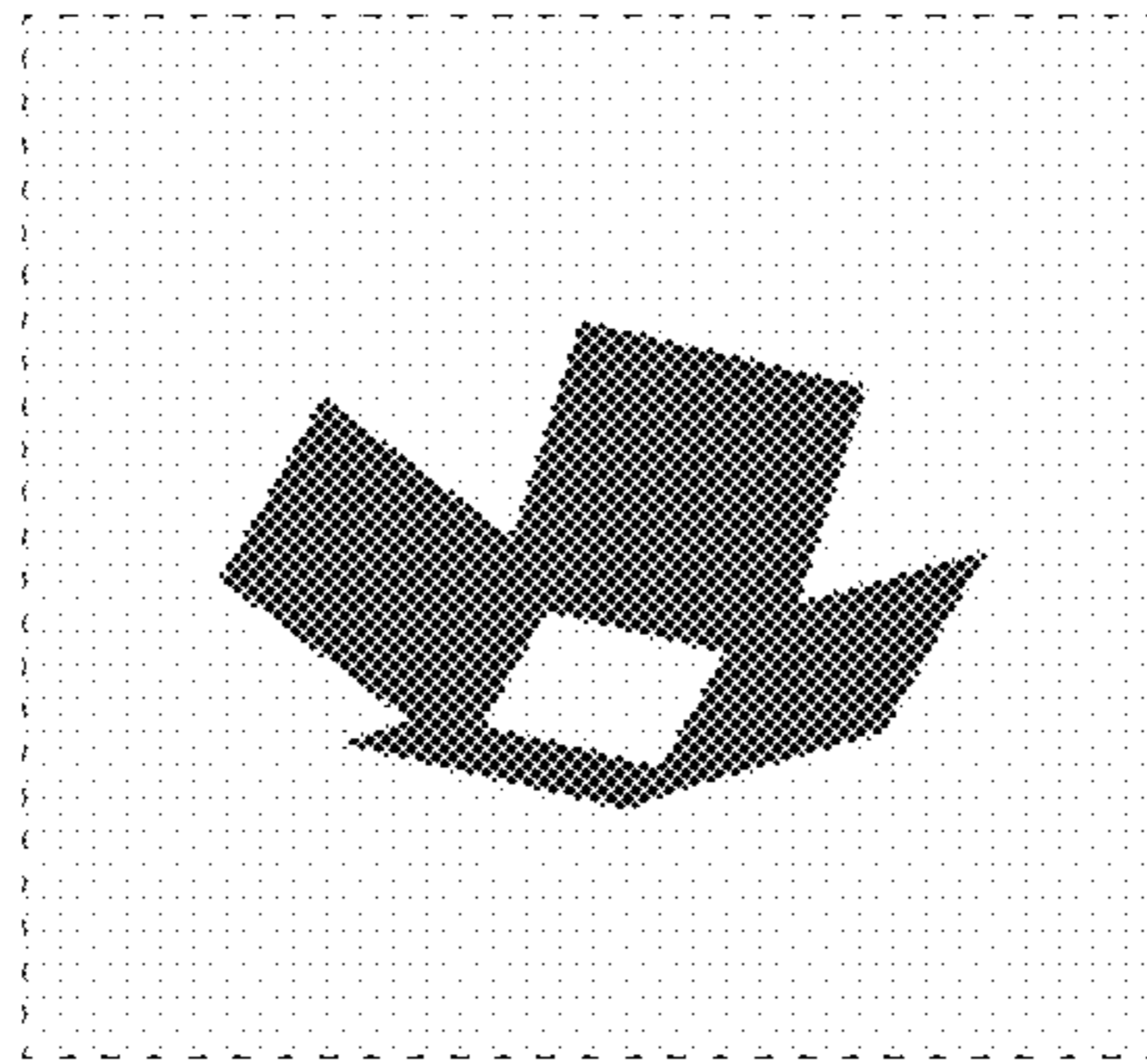

FIG. 10

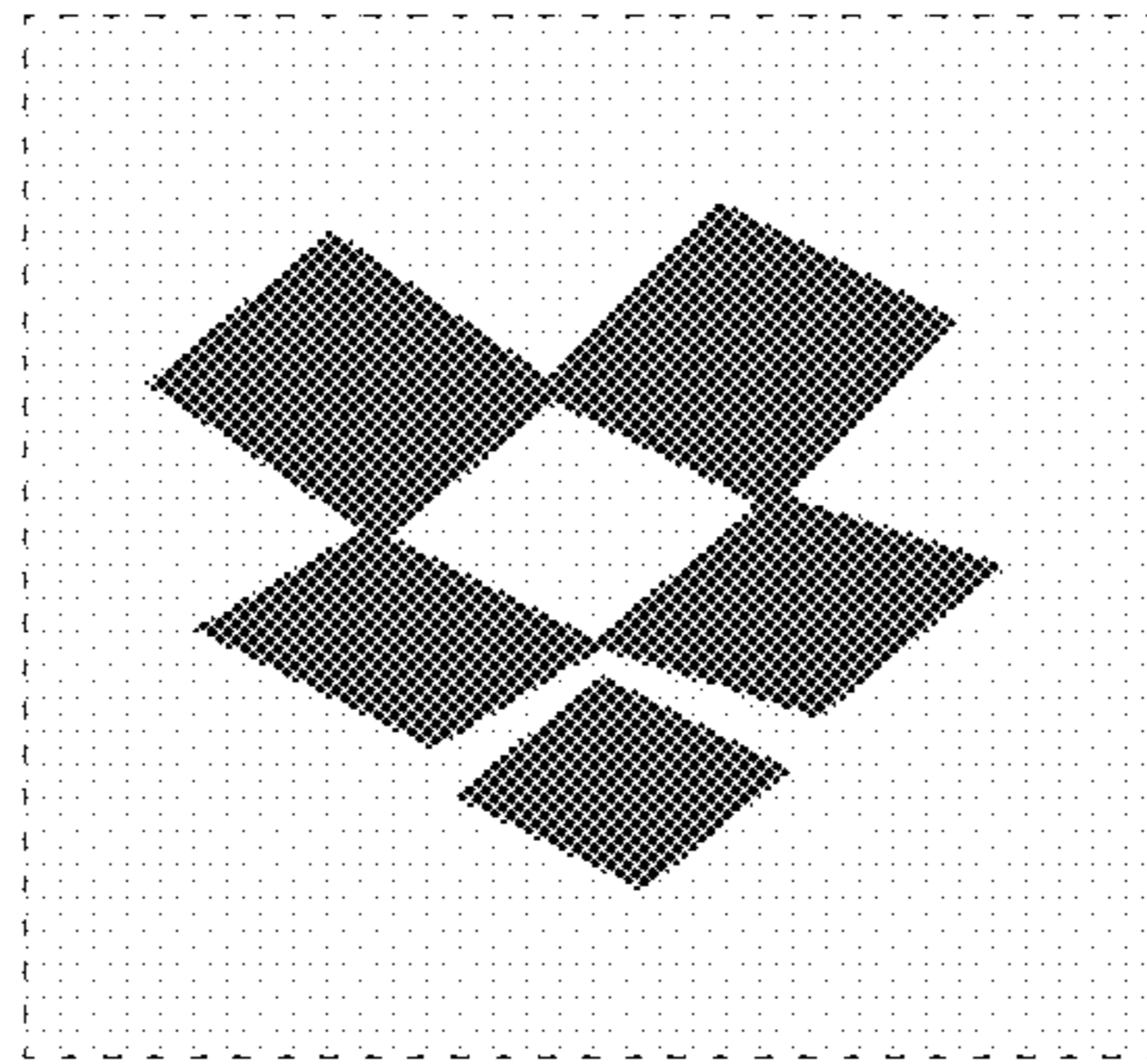

FIG. 11

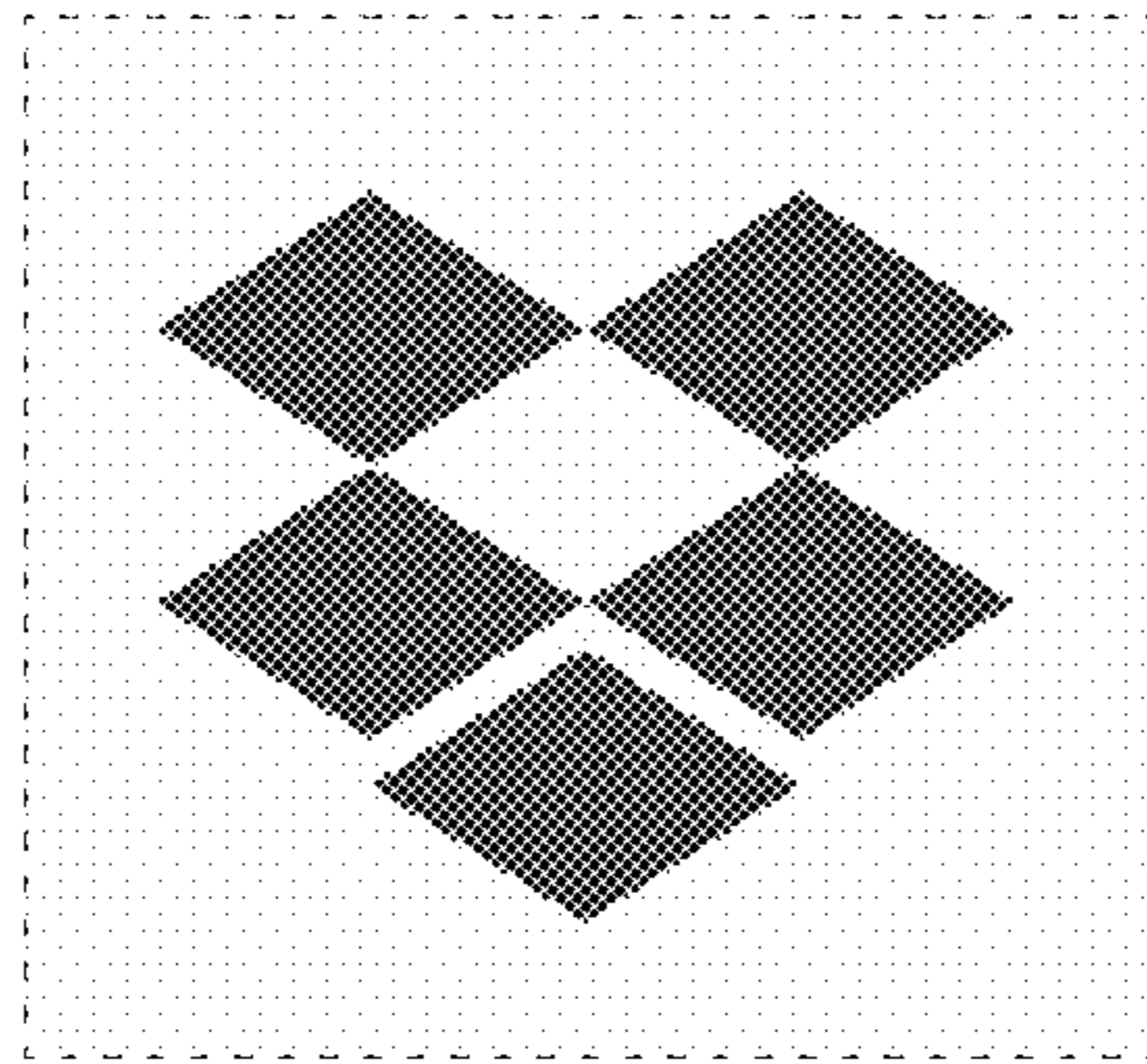

FIG. 12