



US00D981865S

(12) **United States Design Patent**  
**Jerez**

(10) **Patent No.:** **US D981,865 S**

(45) **Date of Patent:** **\*\* Mar. 28, 2023**

(54) **BOTTLE**

(71) Applicant: **Gustavo Jose Cruz Jerez**, Santo Domingo (DO)

(72) Inventor: **Gustavo Jose Cruz Jerez**, Santo Domingo (DO)

(\*\*) Term: **15 Years**

(21) Appl. No.: **29/783,794**

(22) Filed: **May 14, 2021**

(51) **LOC (14) Cl.** ..... **09-01**

(52) **U.S. Cl.**  
USPC ..... **D9/649**; D9/548; D9/572; D9/523

(58) **Field of Classification Search**  
USPC ..... D9/516, 600, 523, 572, 649, 544, 548, D9/552, 553, 554, 562-568, 575  
CPC ..... B65D 67/00; B65D 81/36; B65D 81/60; B65D 81/368; B65D 2203/00; B65D 2203/02; B65D 5/42; B65D 5/4208; B65D 77/00; B65D 1/02; A63H 33/16

See application file for complete search history.

(56) **References Cited**

**U.S. PATENT DOCUMENTS**

D82,593 S *	11/1930	Teague	.....	D9/548
D158,365 S *	5/1950	Fantel	.....	D9/544
D172,316 S *	5/1954	Sanford	.....	D9/649
D253,033 S *	10/1979	Meyer	.....	D9/543
D274,692 S *	7/1984	David	.....	D9/517
D332,225 S *	1/1993	Perret	.....	D9/554
D334,138 S *	3/1993	Larsen	.....	D9/649
D399,075 S *	10/1998	Muntener	.....	D6/674
D438,751 S *	3/2001	Joshua	.....	D7/354
D464,876 S *	10/2002	Davis	.....	D9/649
D482,211 S *	11/2003	Berry	.....	D6/661
D525,411 S *	7/2006	Haro	.....	D1/126
D533,459 S *	12/2006	Wagner	.....	D9/535
D584,185 S *	1/2009	Palmer	.....	D11/110
D595,083 S *	6/2009	Rich	.....	D7/354
D631,054 S *	1/2011	Spier	.....	D14/480.5

D637,088 S *	5/2011	Eisenberger	.....	D9/667
D675,936 S *	2/2013	Ghandour	.....	D9/649
D680,877 S *	4/2013	Ghandour	.....	D9/575
D730,672 S *	6/2015	Darling	.....	D7/319

(Continued)

**OTHER PUBLICATIONS**

Adverts. Afrika Safari Whiskey Empty Bottle Map of Africa Shape Mohan Meakin Africa. Published 2016. Visited Jul. 11, 2022. <https://www.adverts.ie/memorabilia/afrika-safari-whisky-empty-bottle-map-of-africa-shape-mohan-meakin-africa/10055582> (Year: 2016).\*

(Continued)

*Primary Examiner* — Steven J Czyz  
*Assistant Examiner* — Vanessa M. Pursley  
(74) *Attorney, Agent, or Firm* — Leason Ellis LLP

(57) **CLAIM**

The ornamental design for a bottle, as shown and described.

**DESCRIPTION**

FIG. 1 is a front and right side view of a bottle showing a first embodiment of my new ornamental design;  
FIG. 2 is a front view thereof;  
FIG. 3 is a rear view thereof;  
FIG. 4 is a right side view thereof;  
FIG. 5 is a left side view thereof;  
FIG. 6 is a top plan view; and  
FIG. 7 is a bottom plan view thereof;  
FIG. 8 is a front and right side view of a bottle showing a second embodiment of my new ornamental design;  
FIG. 9 is a front view thereof;  
FIG. 10 is a rear view thereof;  
FIG. 11 is a right side view thereof;  
FIG. 12 is a left side view thereof;  
FIG. 13 is a top plan view; and,  
FIG. 14 is a bottom plan view thereof.

**1 Claim, 14 Drawing Sheets**

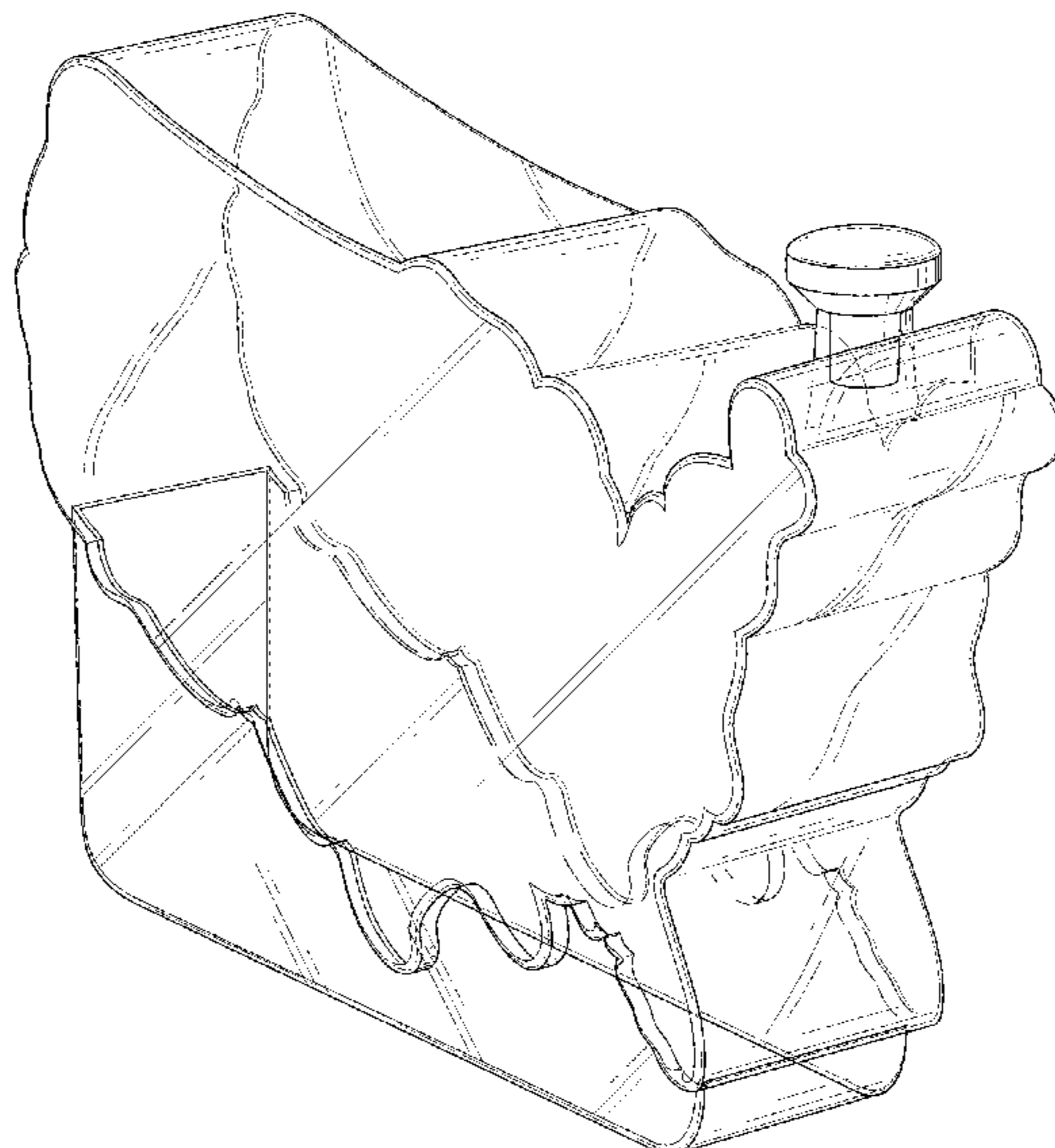

(56)

**References Cited**

## U.S. PATENT DOCUMENTS

D859,995	S	*	9/2019	Mai	.....	D9/652
D864,733	S	*	10/2019	Franco	.....	D9/544
D864,734	S	*	10/2019	Franco	.....	D9/544
D864,735	S	*	10/2019	Franco	.....	D9/544
D864,736	S	*	10/2019	Franco	.....	D9/544
D864,737	S	*	10/2019	Franco	.....	D9/544
D864,738	S	*	10/2019	Franco	.....	D9/544
D864,739	S	*	10/2019	Franco	.....	D9/544
D864,742	S	*	10/2019	Franco	.....	D9/544
D864,743	S	*	10/2019	Franco	.....	D9/544
D865,533	S	*	11/2019	Franco	.....	D9/600
D882,408	S	*	4/2020	Franco	.....	D9/544
D883,099	S	*	5/2020	Larminaux	.....	D9/600
D895,431	S	*	9/2020	Franco	.....	D9/652
D906,828	S	*	1/2021	Franco	.....	D9/544
D932,308	S	*	10/2021	Franco	.....	D9/544

## OTHER PUBLICATIONS

Pinterest. Italy Map. Published by Leah Glickman, publication date unavailable. Visited Jul. 11, 2022. <https://www.pinterest.com/pin/olive-oil-in-bottles-shaped-like-the-map-of-italyshop-in-rome--492018328015693082/> (Year: 0).\*

Amazon. Whiskey Decanter on USA Map Tray. First available Oct. 1, 2018. Visited Jul. 11, 2022. <https://www.amazon.com/Whiskey-Decanter-USA-Map-Tray/dp/B07NZJG38> (Year: 2018).\*

Ebay. American flag Shaped like the USA lapel pin. Publication date unavailable. Visited Jul. 11, 2022. <https://www.ebay.com/itm/173824963963> (Year: 0).\*

\* cited by examiner

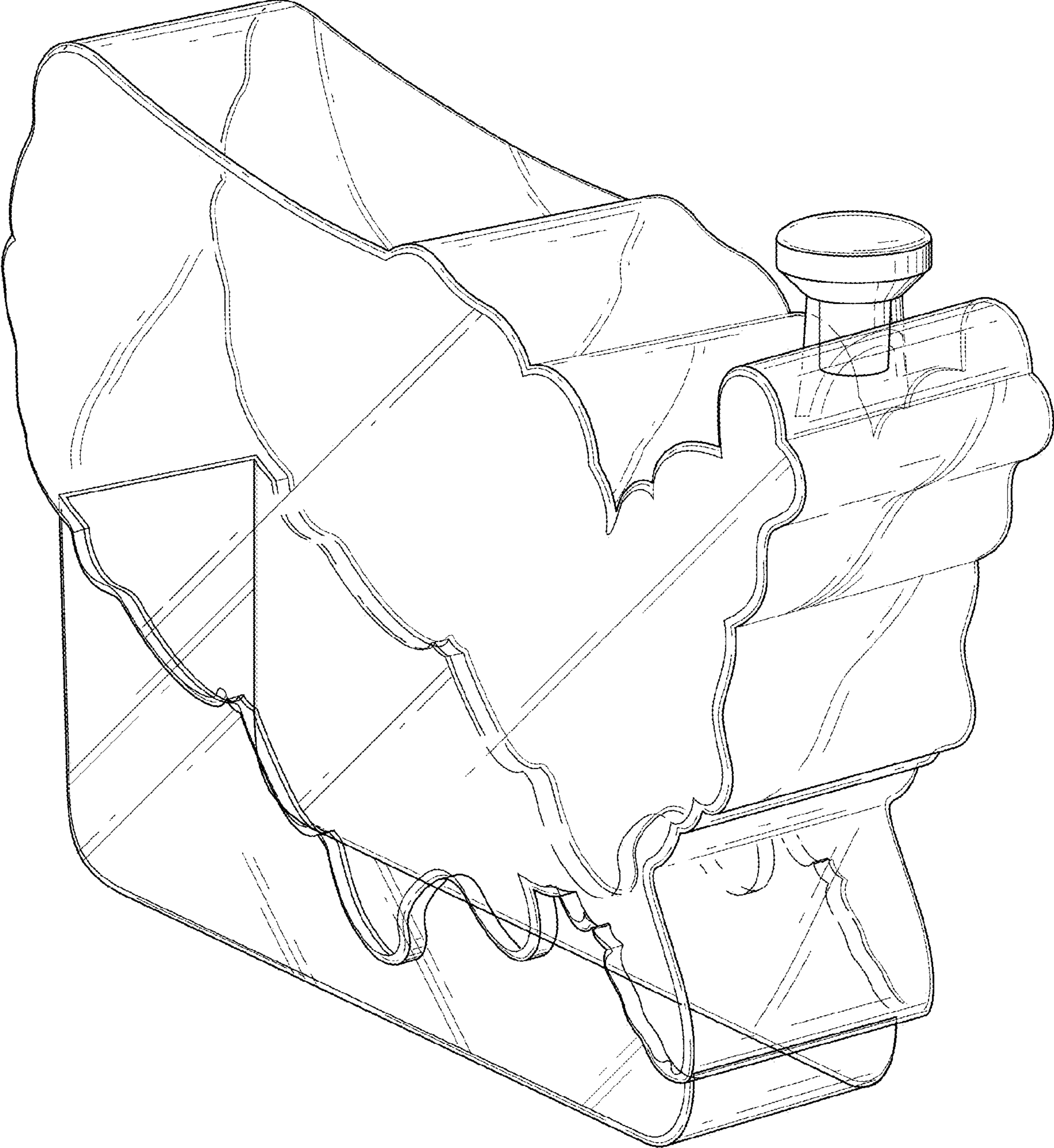

Fig. 1



Fig. 2

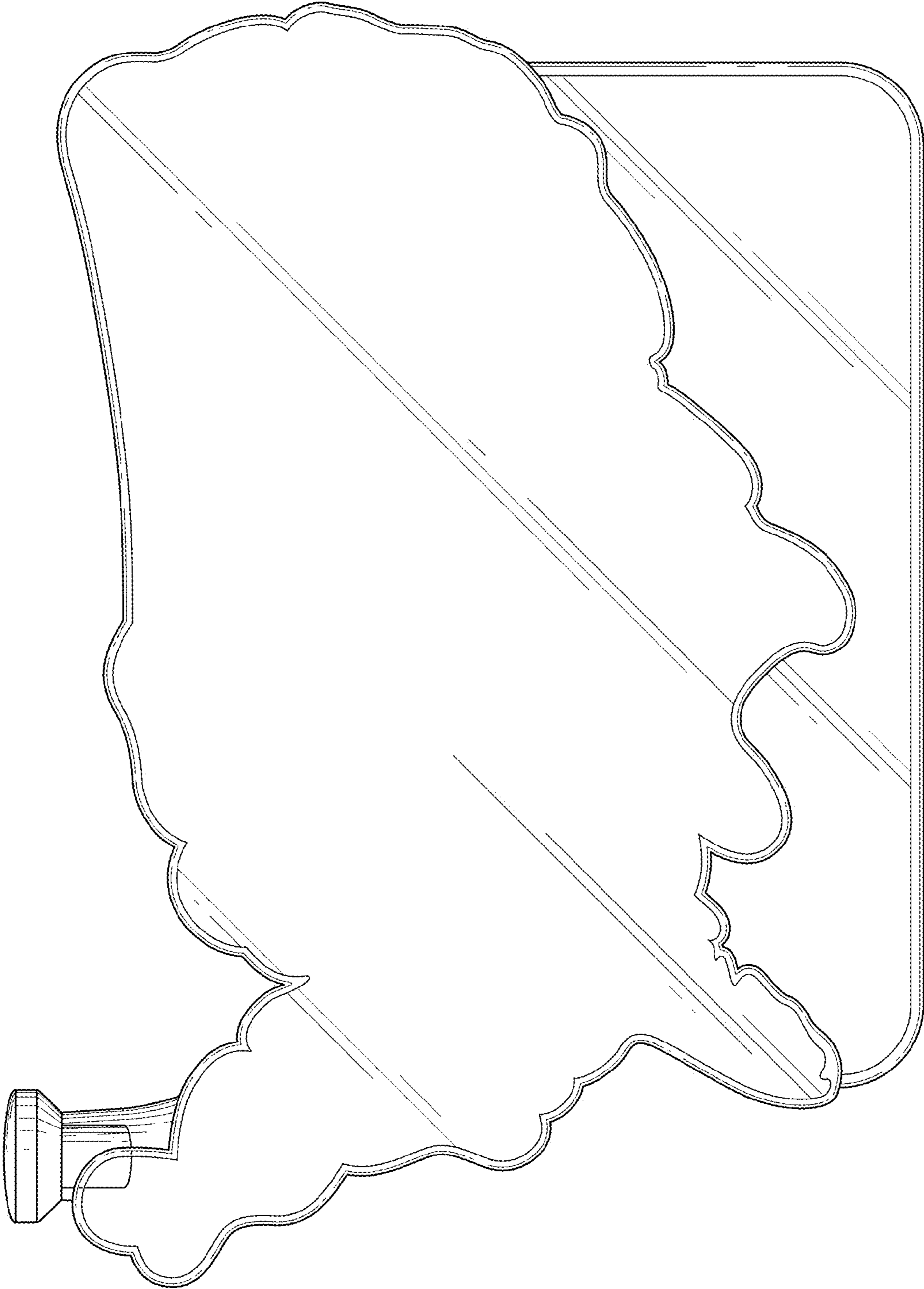

Fig. 3

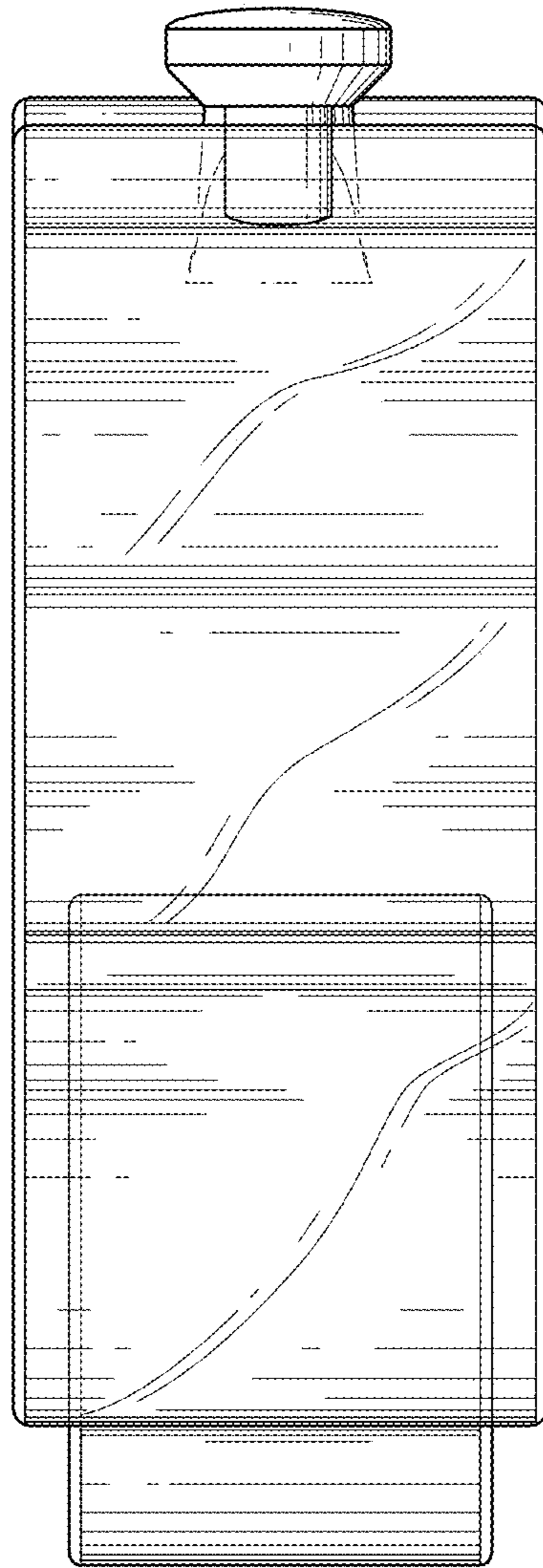

Fig. 4

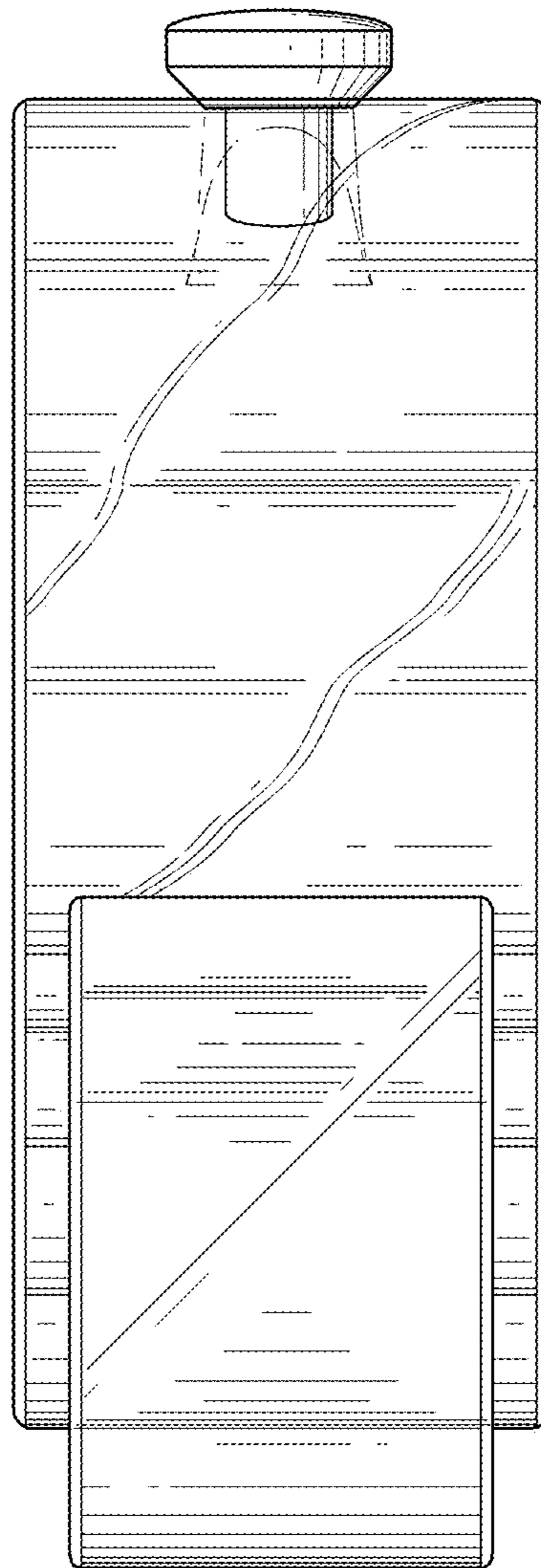

Fig. 5

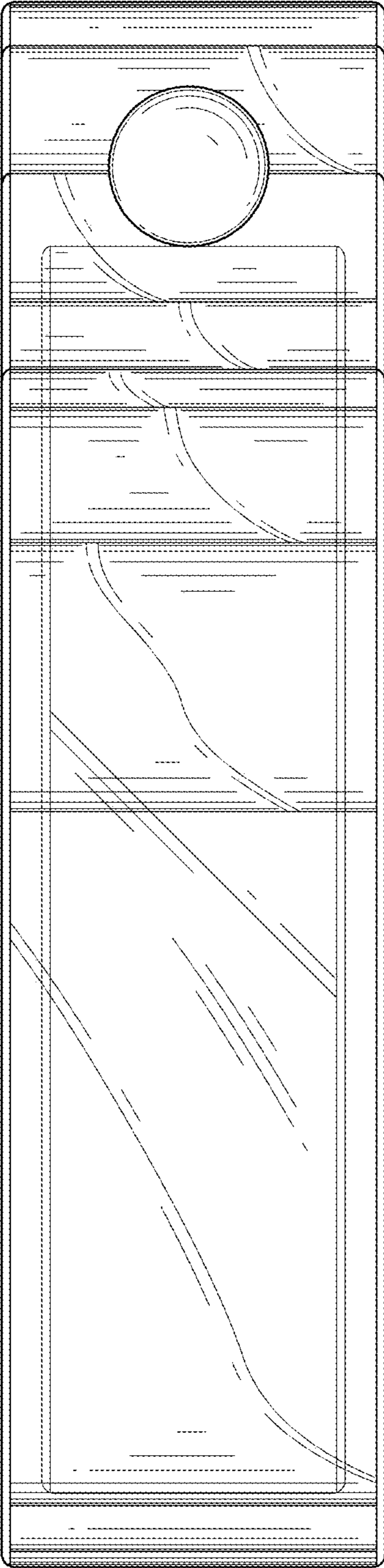

Fig. 6



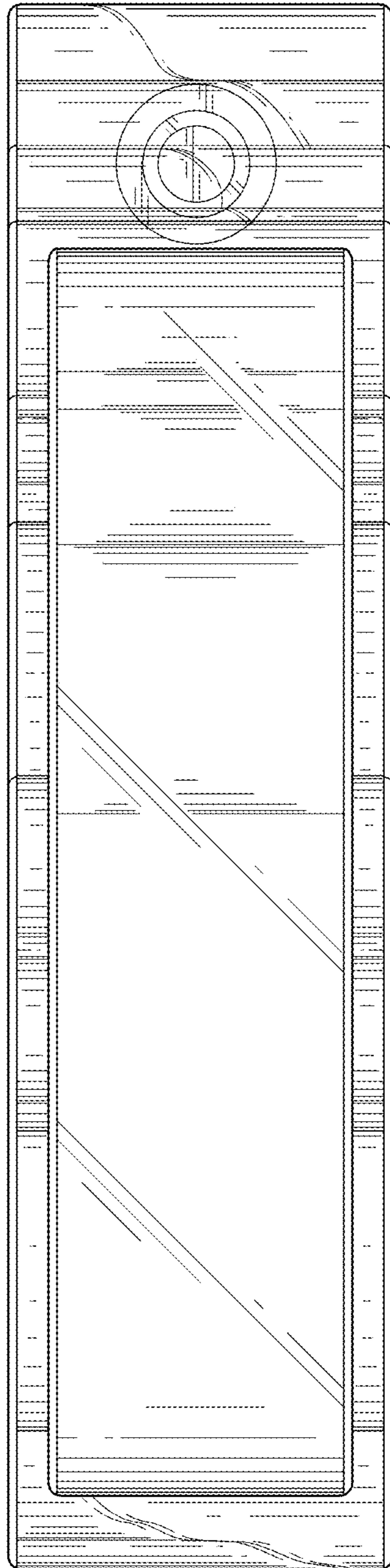

Fig. 7

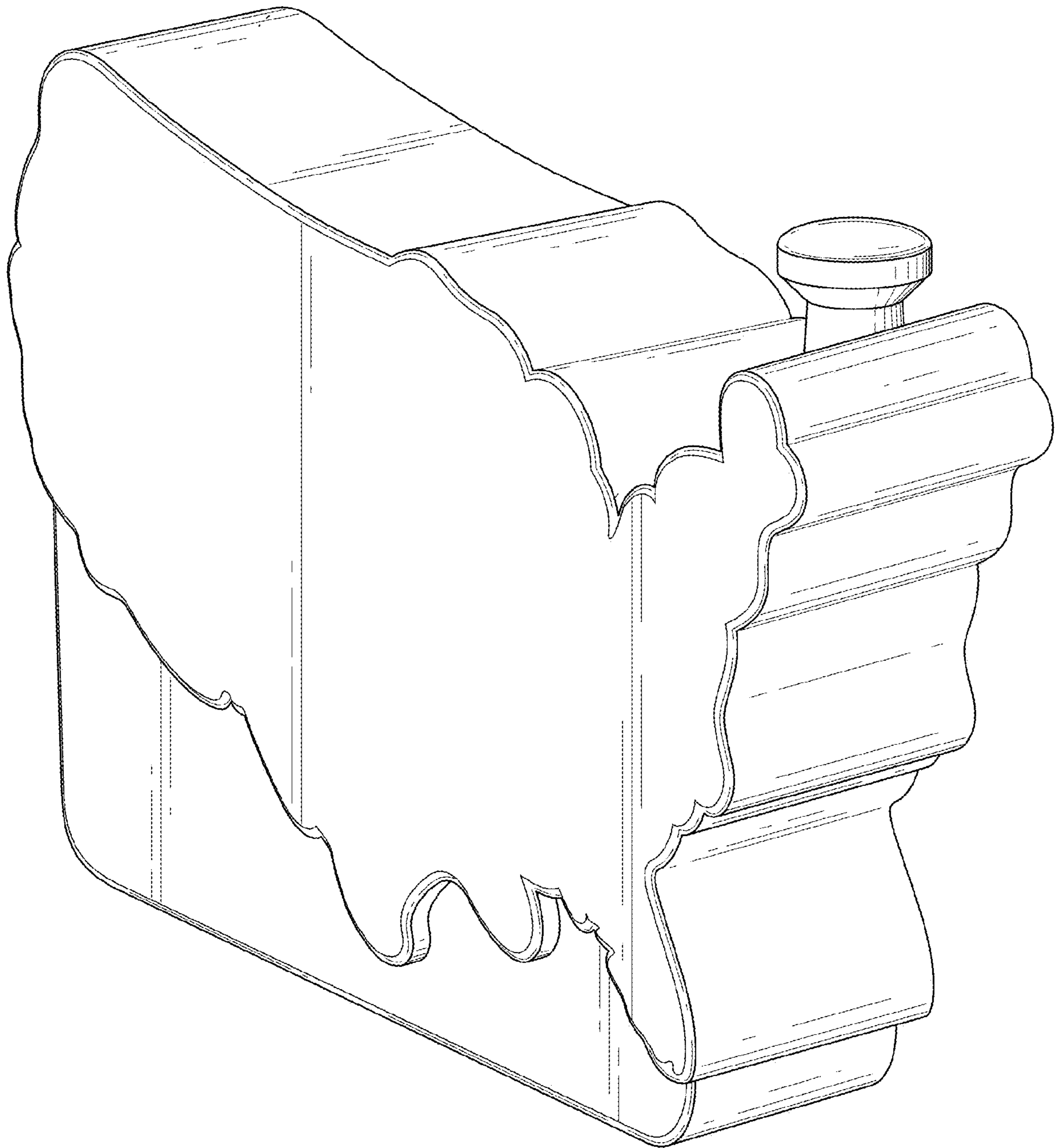

Fig. 8

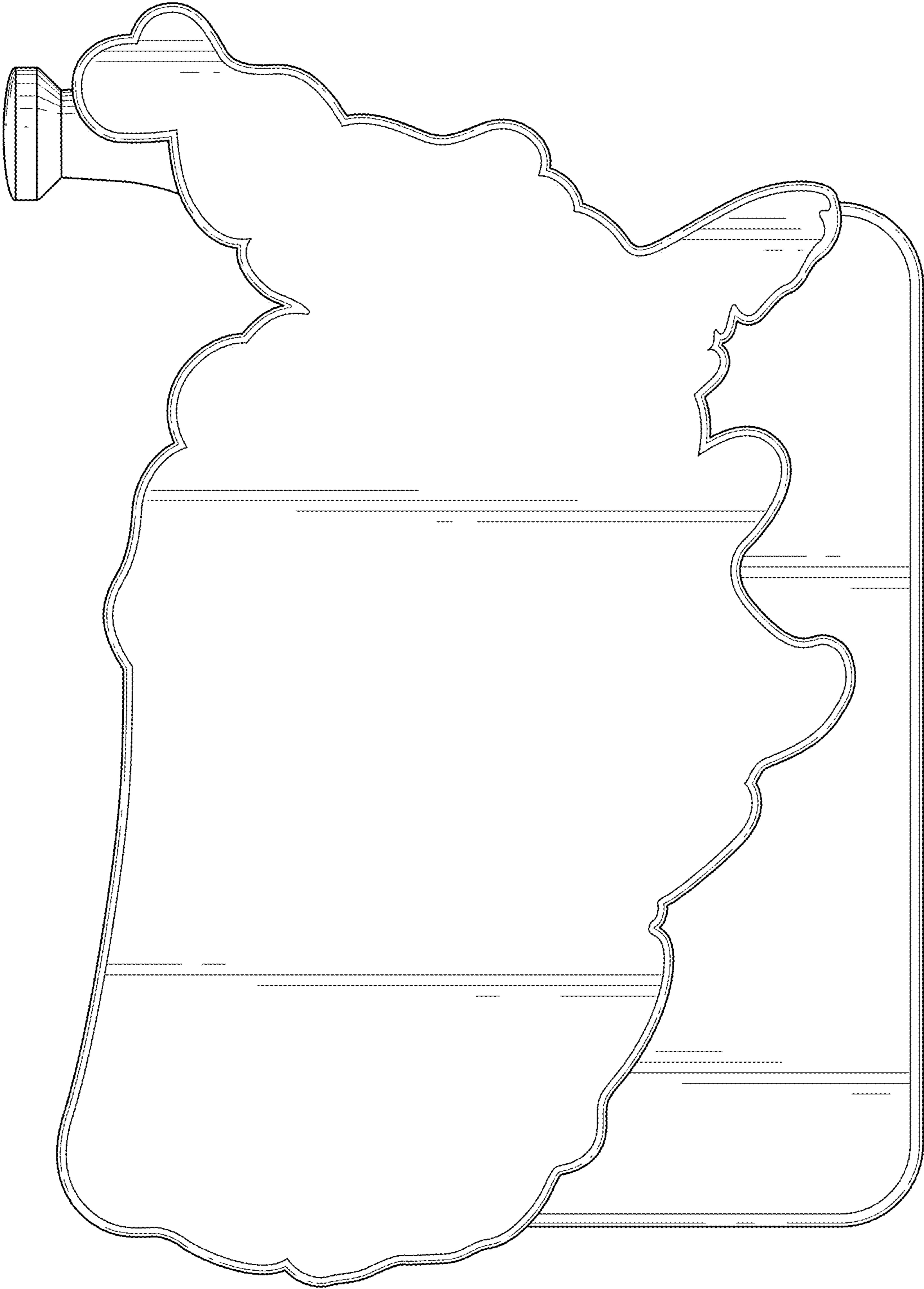

Fig. 9

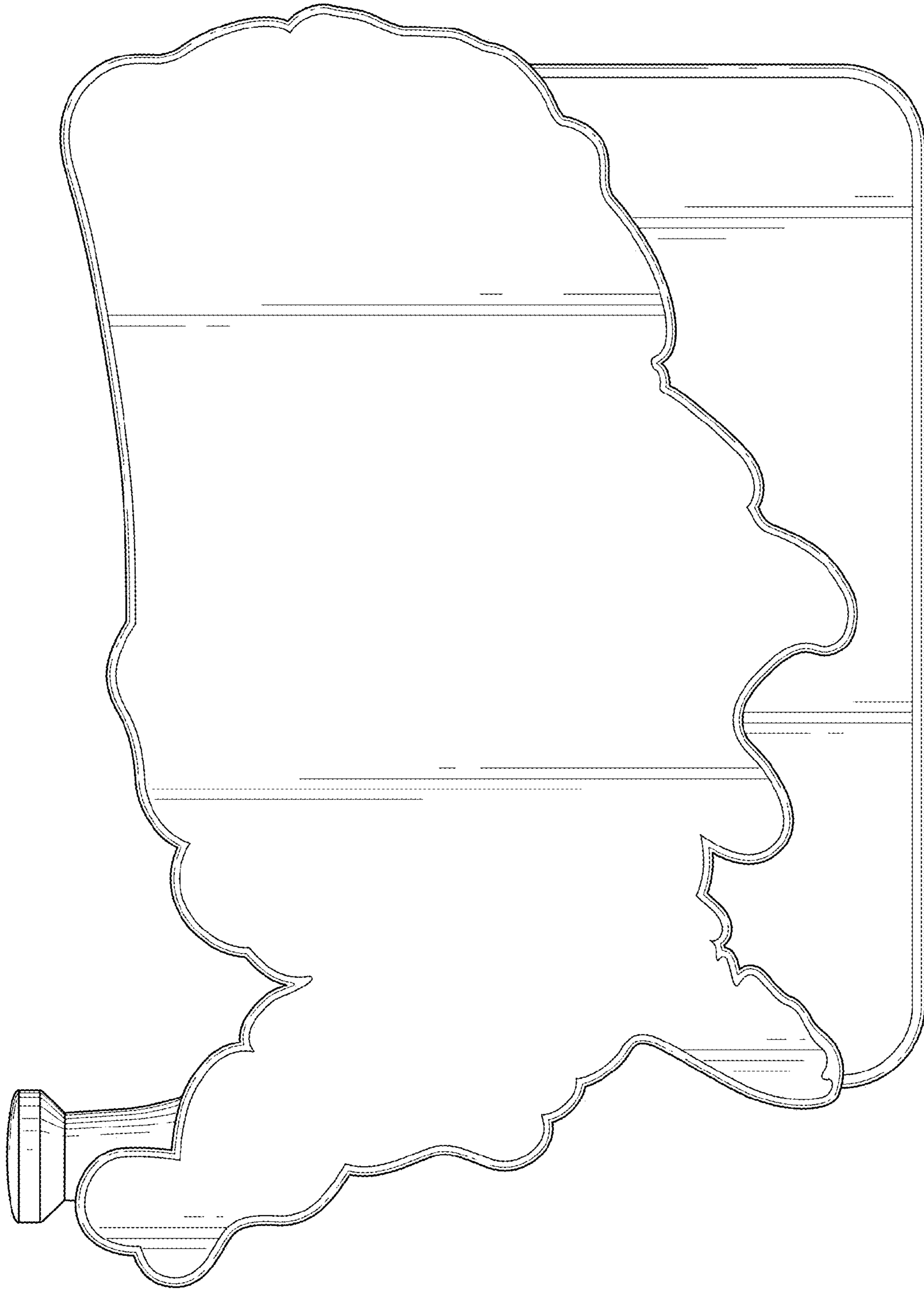

Fig. 10

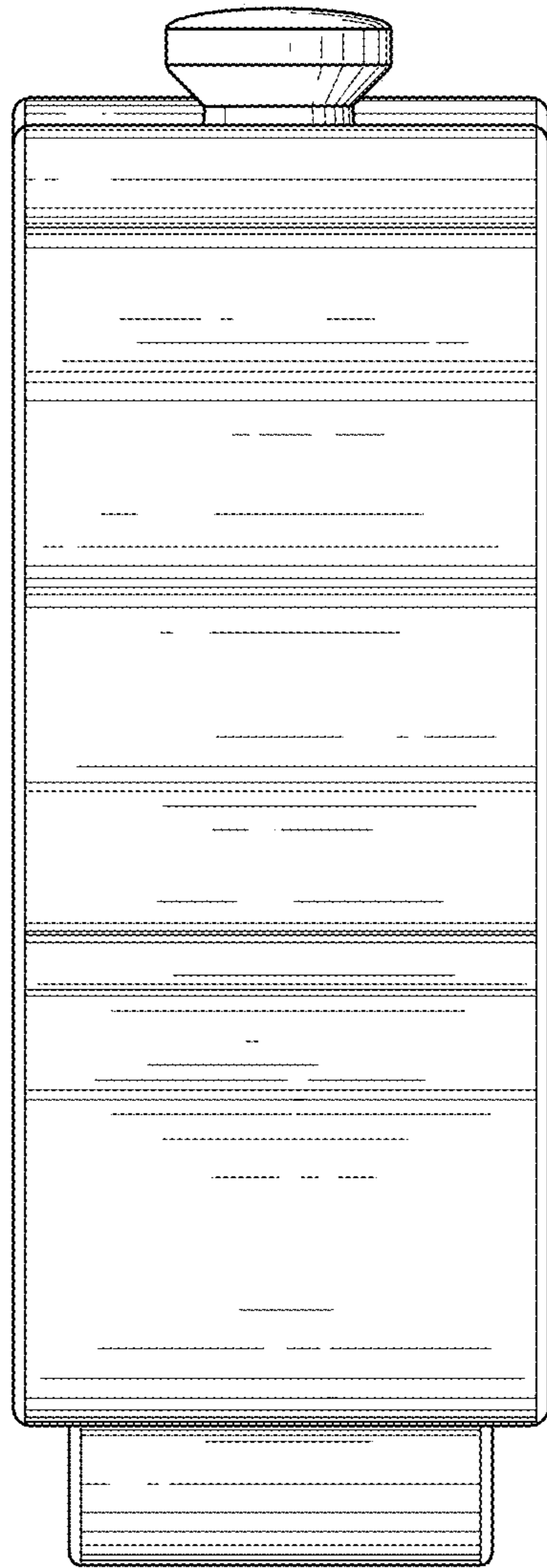

Fig. 11

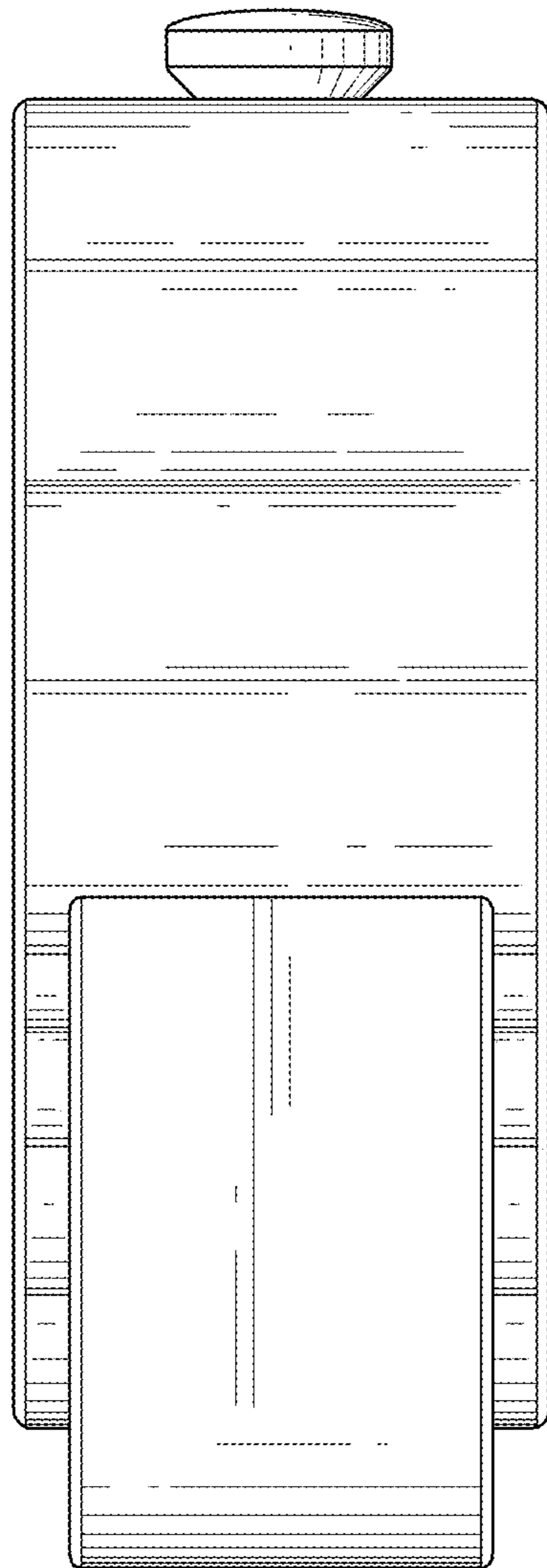

Fig. 12

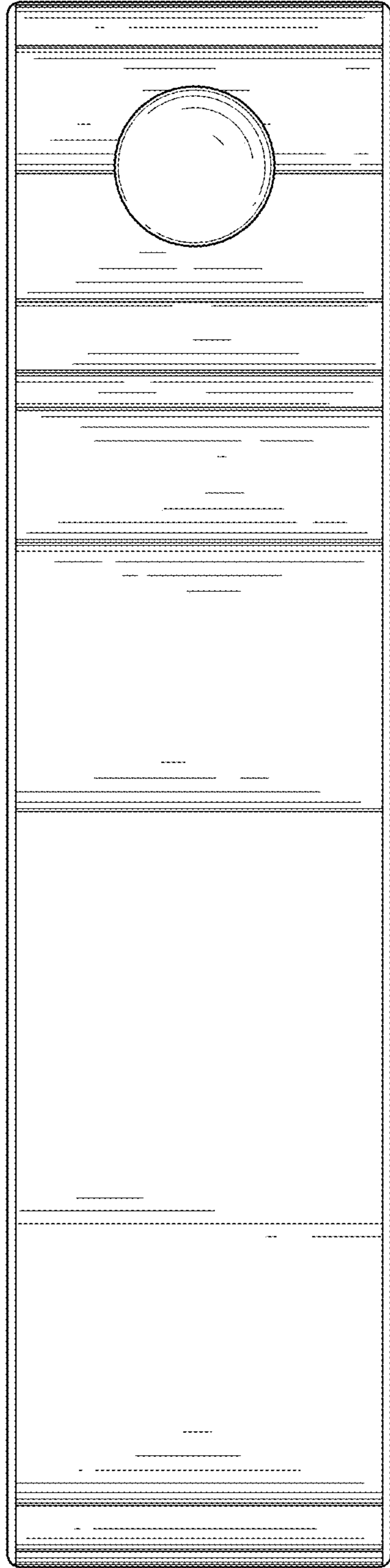

Fig. 13

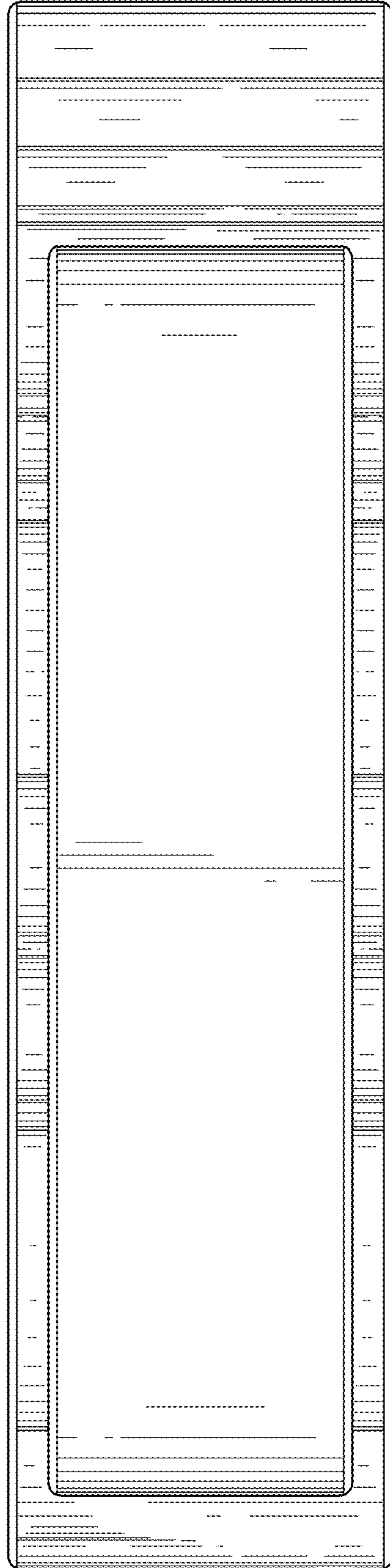

Fig. 14