



US00D981751S

(12) **United States Design Patent**
Yu

(10) **Patent No.:** **US D981,751 S**

(45) **Date of Patent:** **** Mar. 28, 2023**

(54) **TOOTHBRUSH HOLDER**

(71) Applicant: **Lihua Yu**, Ningbo (CN)

(72) Inventor: **Lihua Yu**, Ningbo (CN)

(**) Term: **15 Years**

(21) Appl. No.: **29/854,345**

(22) Filed: **Sep. 23, 2022**

(51) **LOC (14) Cl.** **23-02**

(52) **U.S. Cl.**
USPC **D6/528**

(58) **Field of Classification Search**
USPC D6/512, 513, 524, 525, 526, 528, 531,
D6/532, 534, 535, 536, 540, 553, 566;
D32/52, 55; D34/7; 211/13.1, 71.01, 74,
211/75, 86.01, 126.1, 133.5, 134, 181.1
CPC A47K 17/00; A47K 3/281; A47K 3/001;
A47K 3/004; A47K 5/00; A47K 5/03;
B23P 17/04; A47B 57/265; A47B 57/565;
A47B 57/26; A47J 47/16; A47J 47/201
See application file for complete search history.

(56) **References Cited**

U.S. PATENT DOCUMENTS

D154,495 S * 7/1949 Keller D6/531
D268,531 S * 4/1983 Leppard D27/181
D306,811 S * 3/1990 DeLeon D6/531

D347,346 S * 5/1994 Shames D6/531
D385,136 S * 10/1997 Gutke D6/524
D386,639 S * 11/1997 Everett D6/525
D432,833 S * 10/2000 Gastelum D6/531
D604,975 S * 12/2009 Racanelli D6/534
D648,164 S * 11/2011 Michnuk D6/534
D717,067 S * 11/2014 Collado D6/528
D745,789 S * 12/2015 Volk D6/534
D762,934 S * 8/2016 Evans D32/55
D851,422 S * 6/2019 Joseph
D885,700 S * 5/2020 Joseph D32/55

* cited by examiner

Primary Examiner — Nathan M Johnston

(57) **CLAIM**

The ornamental design for a toothbrush holder, as shown and described.

DESCRIPTION

FIG. 1 is a front and top perspective view of a toothbrush holder, showing my new design;
FIG. 2 is a rear and bottom perspective view thereof;
FIG. 3 is a front elevation view thereof;
FIG. 4 is a rear elevation view thereof;
FIG. 5 is a left side elevation view thereof;
FIG. 6 is a right side elevation view thereof;
FIG. 7 is a top plan view thereof; and,
FIG. 8 is a bottom plan view thereof.
The broken lines in the figures illustrate portions of the toothbrush holder that form no part of the claimed design.

1 Claim, 8 Drawing Sheets

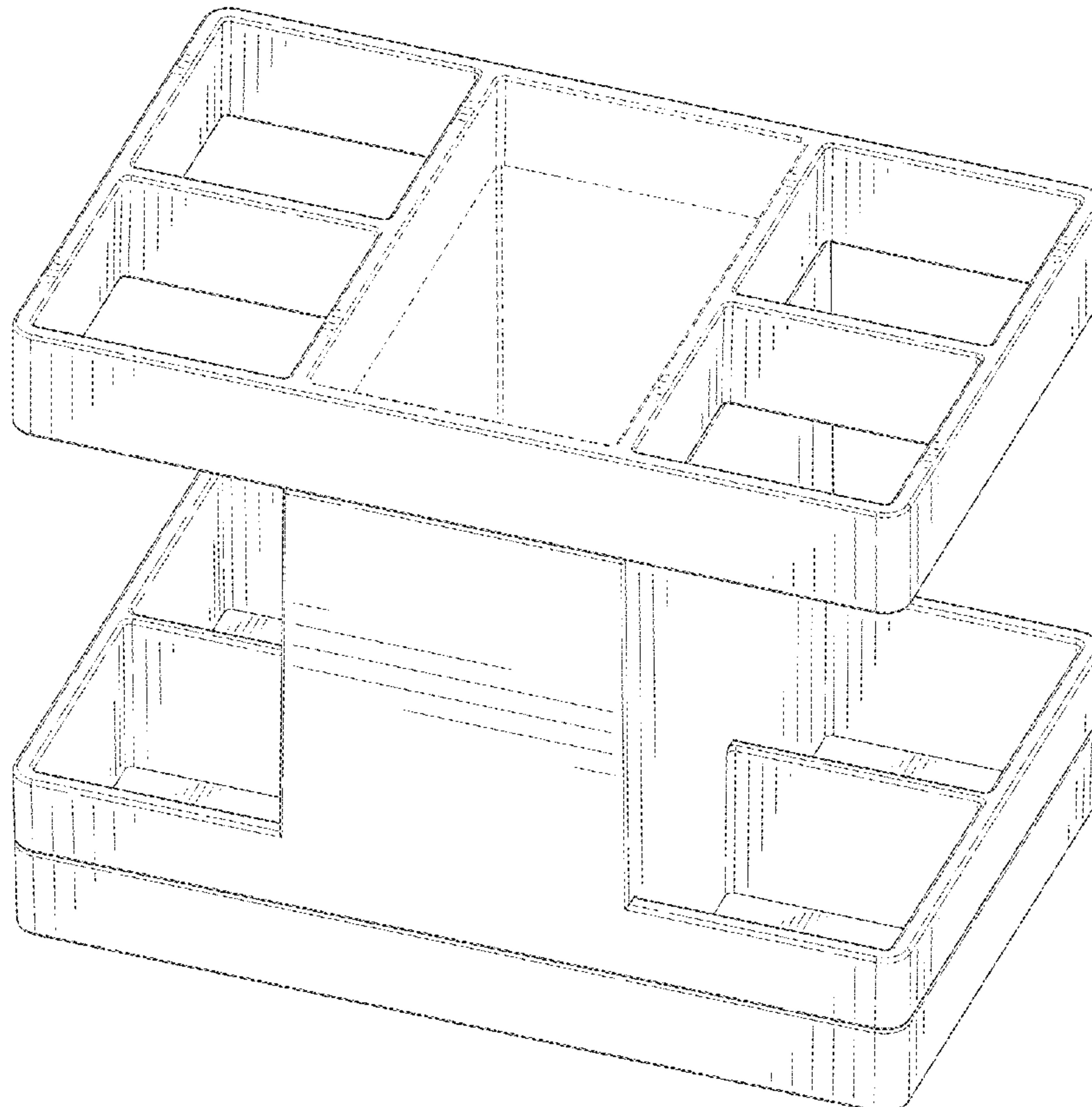

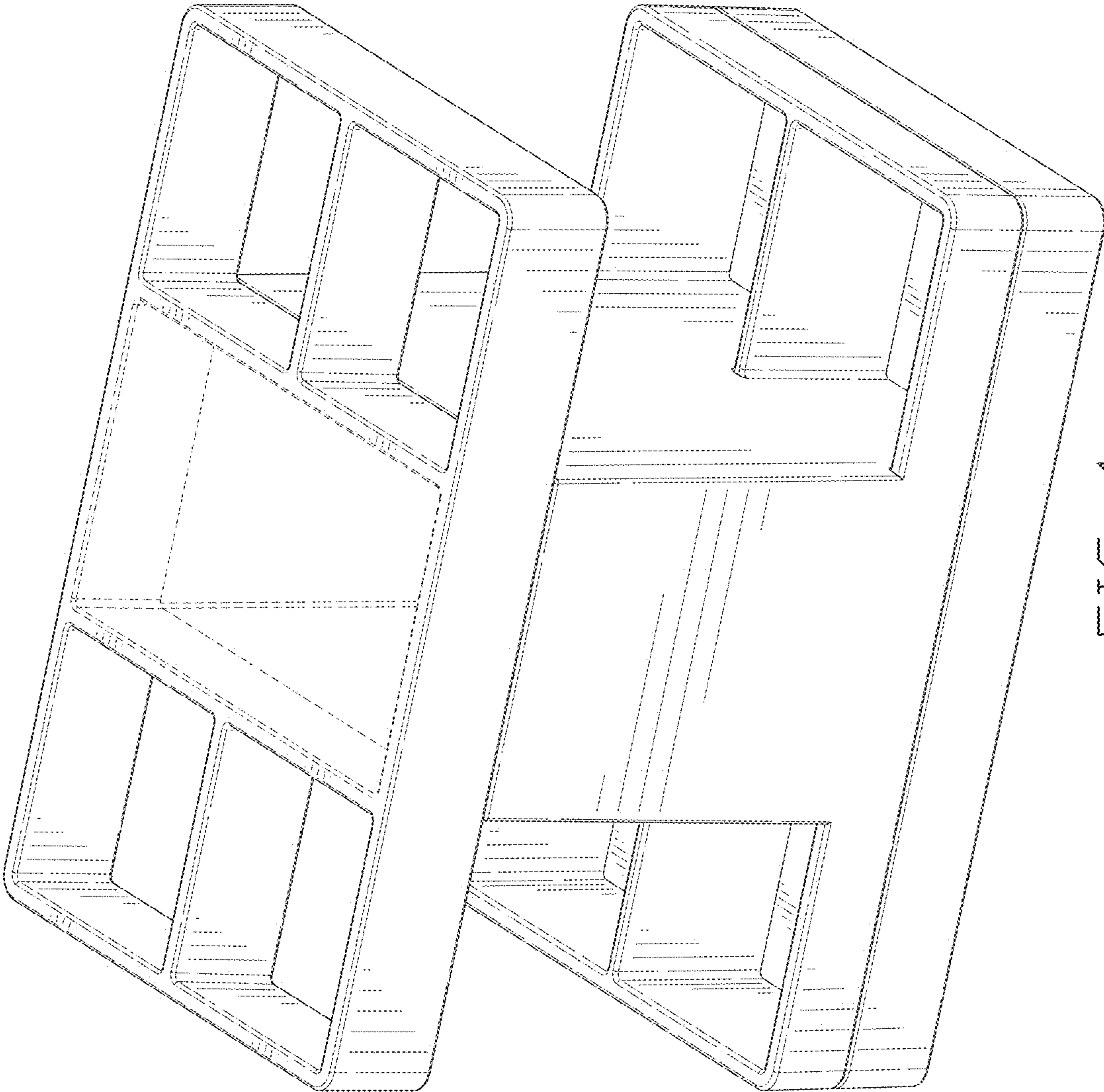

FIG. 1

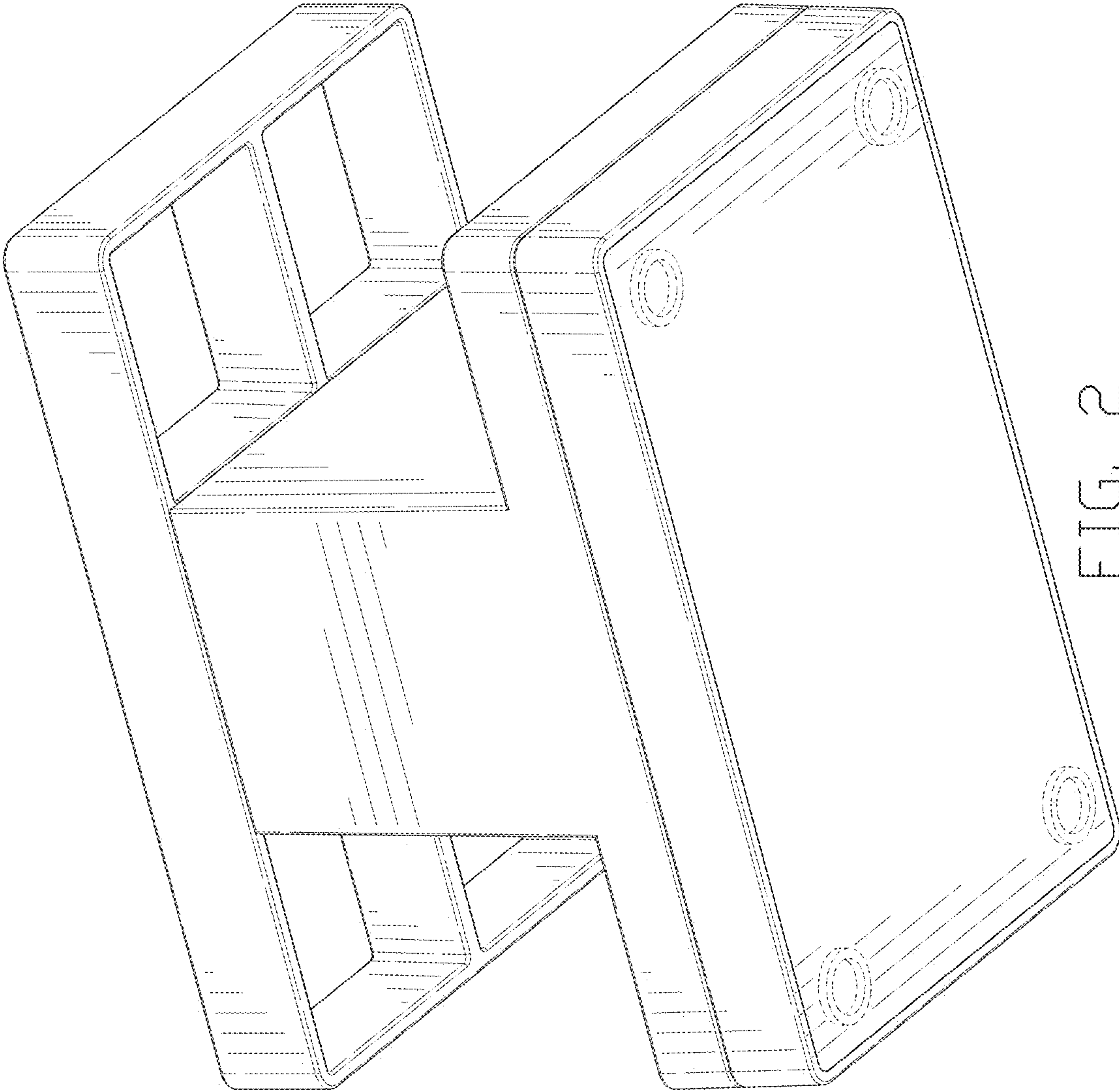

FIG. 2

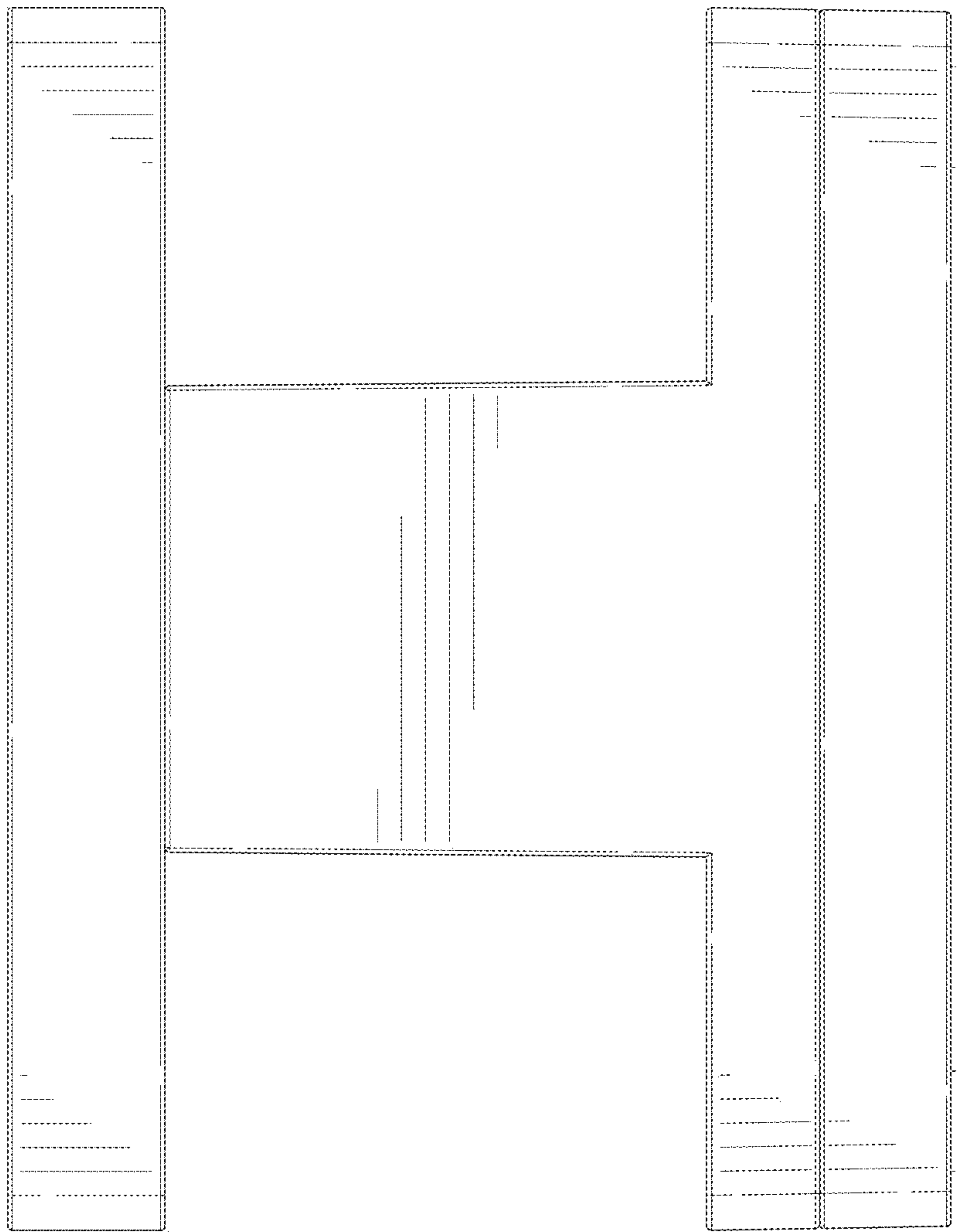

FIG. 3

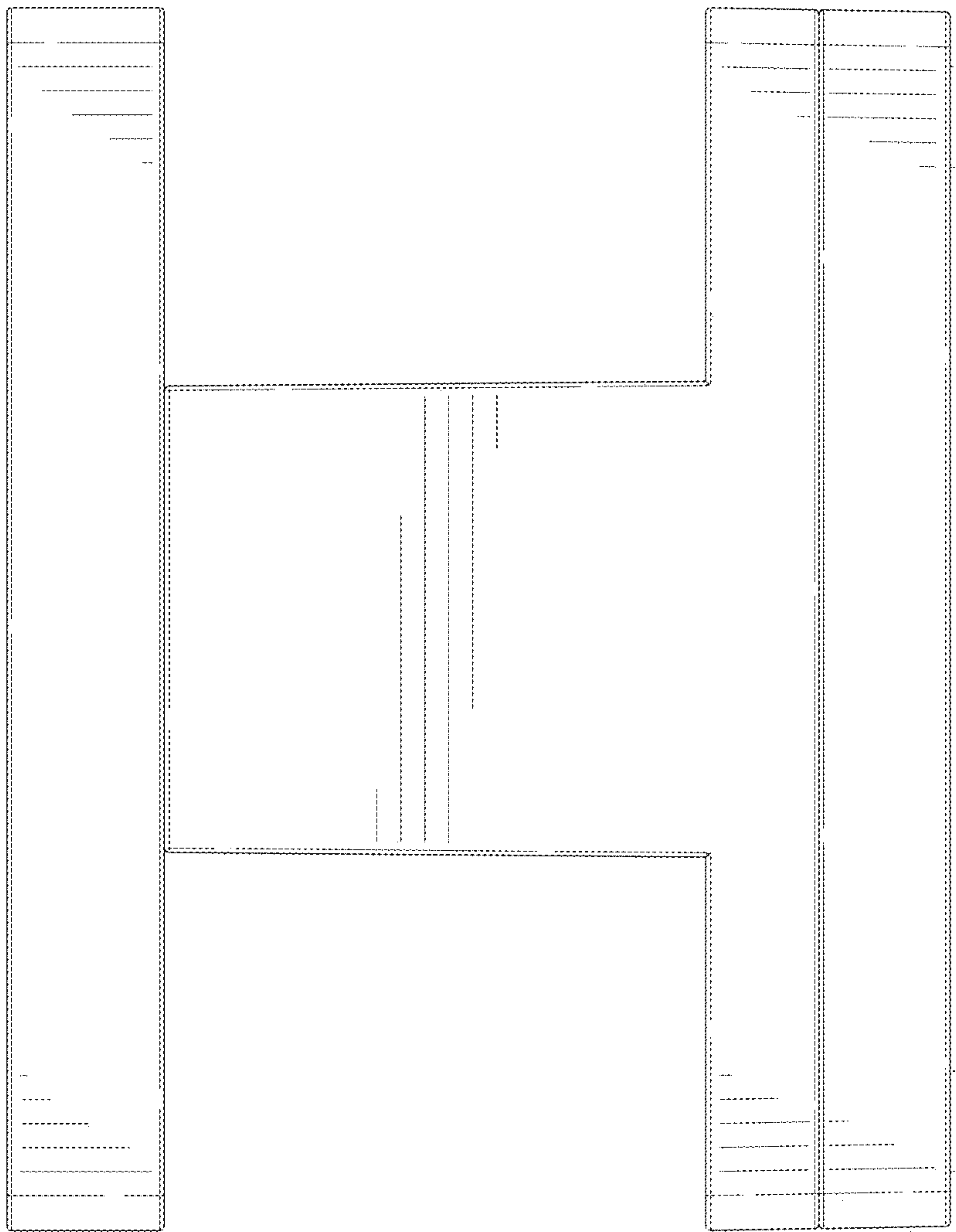

FIG. 4

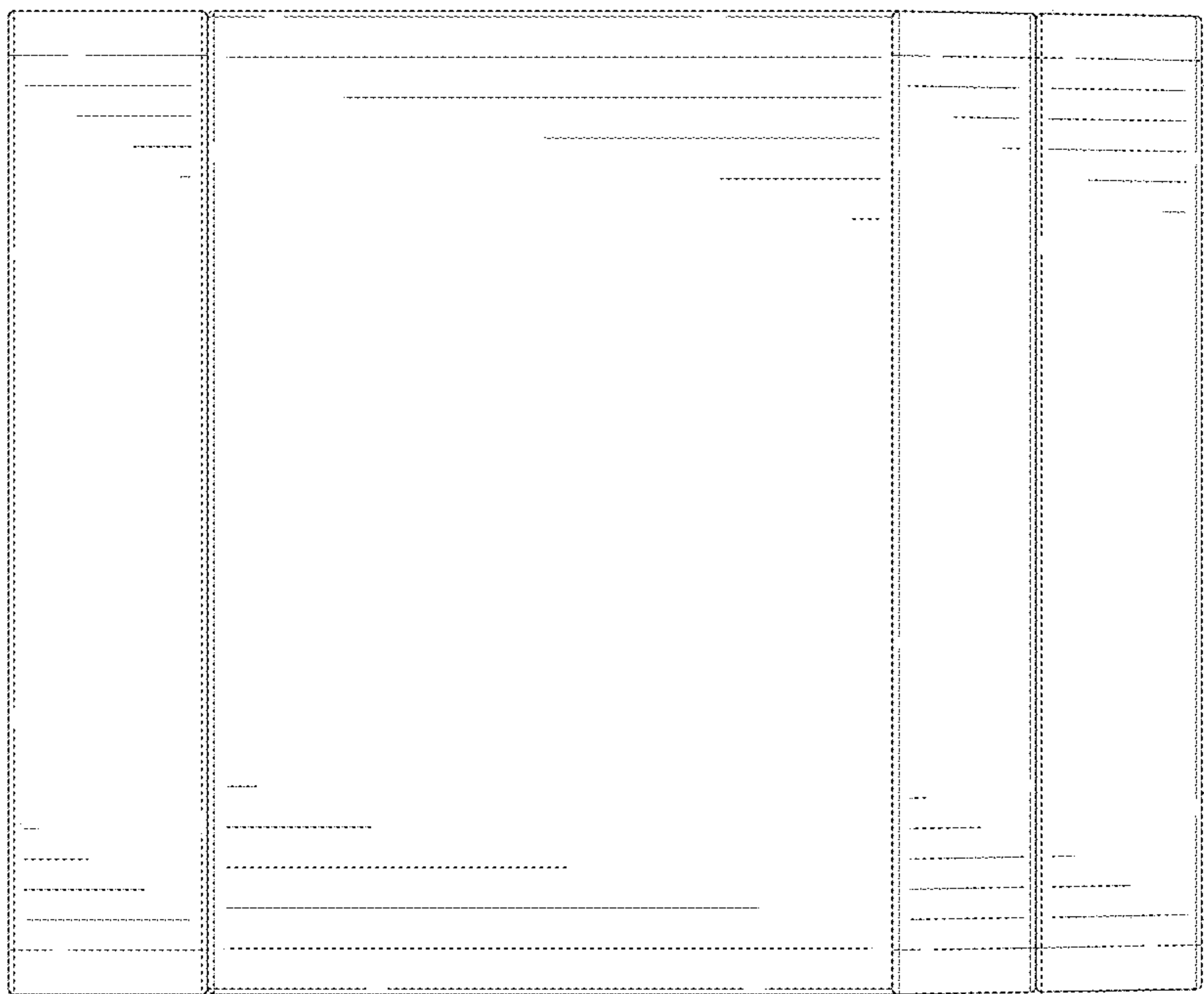

FIG. 5

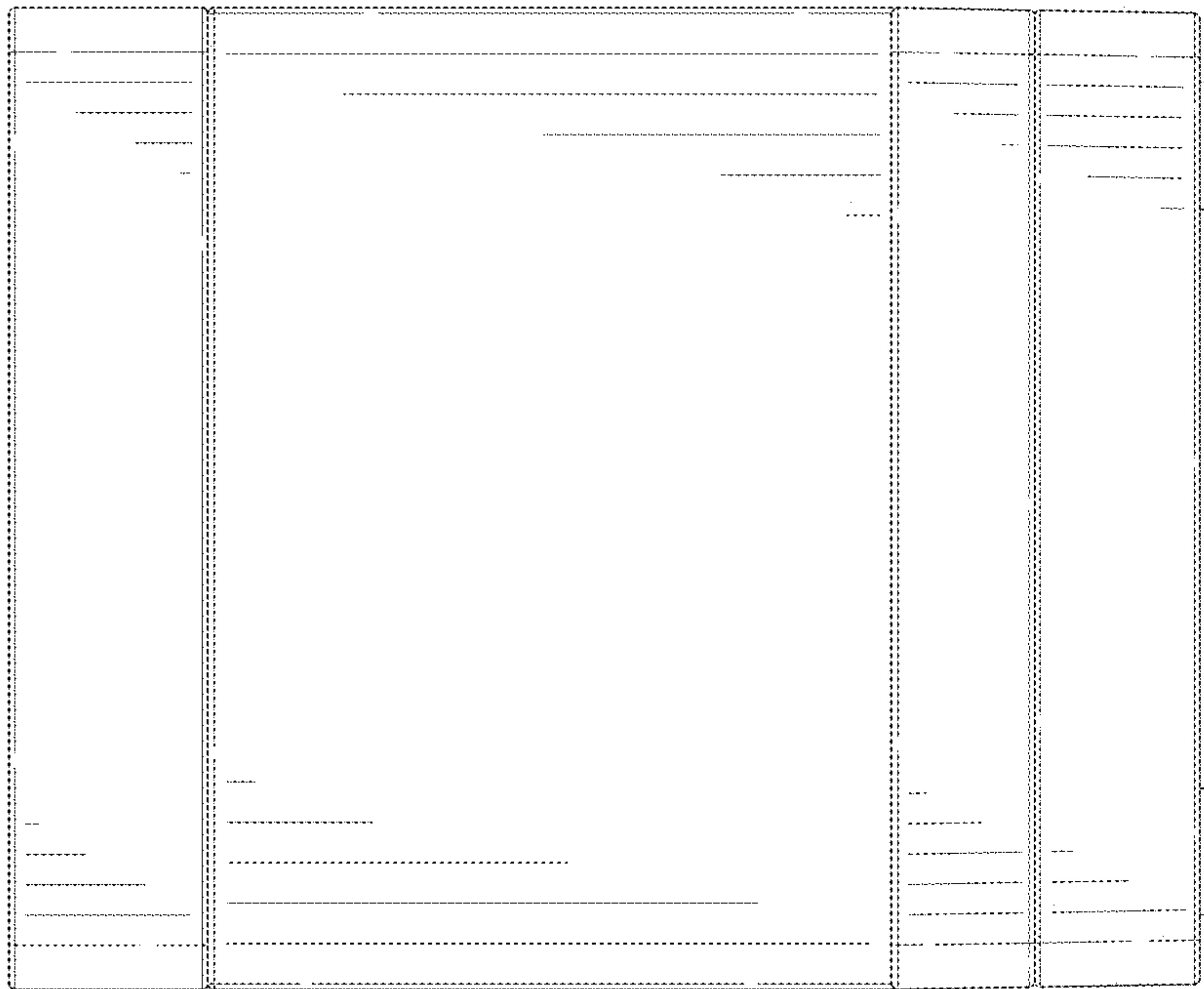

FIG. 6

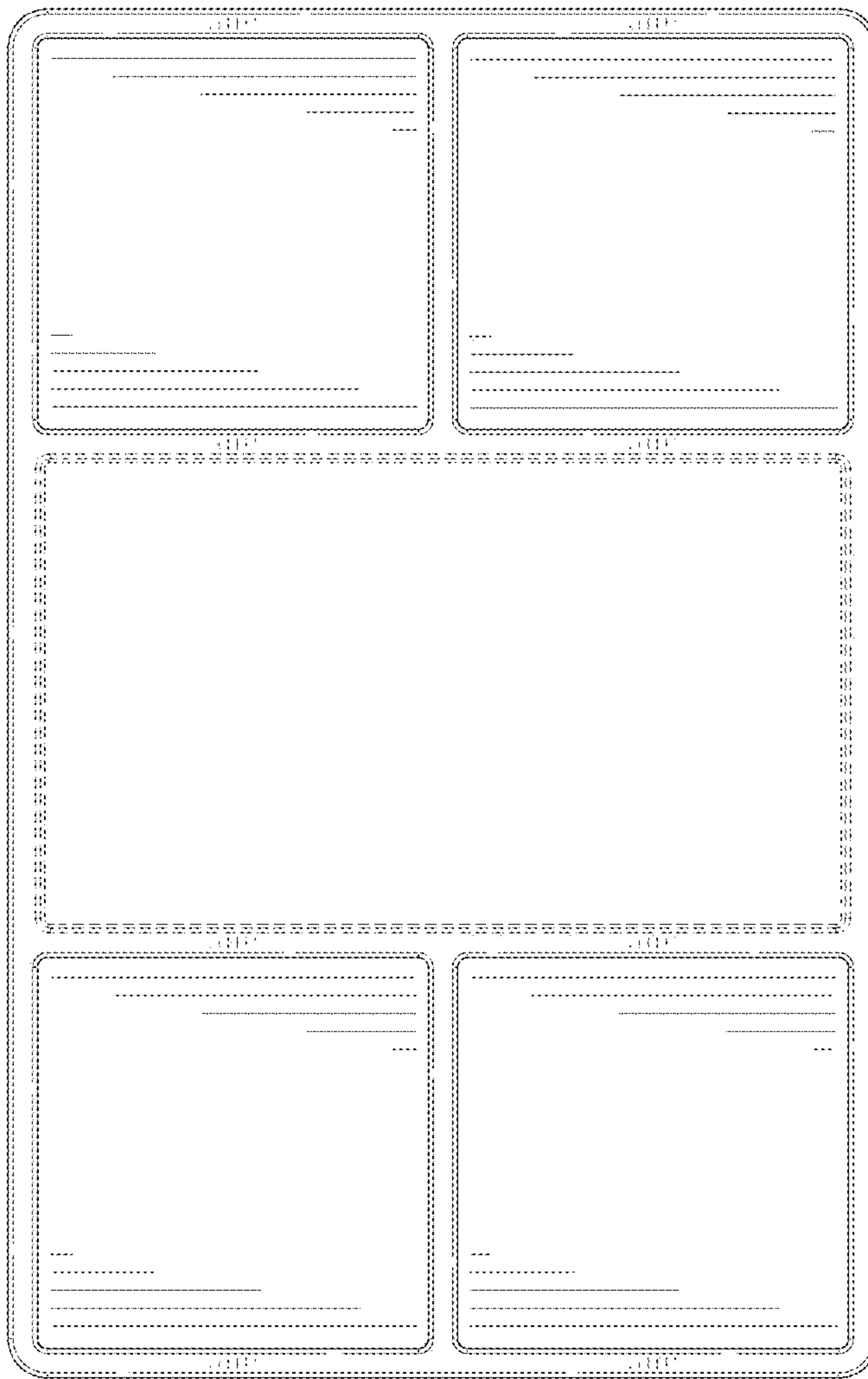

FIG. 7

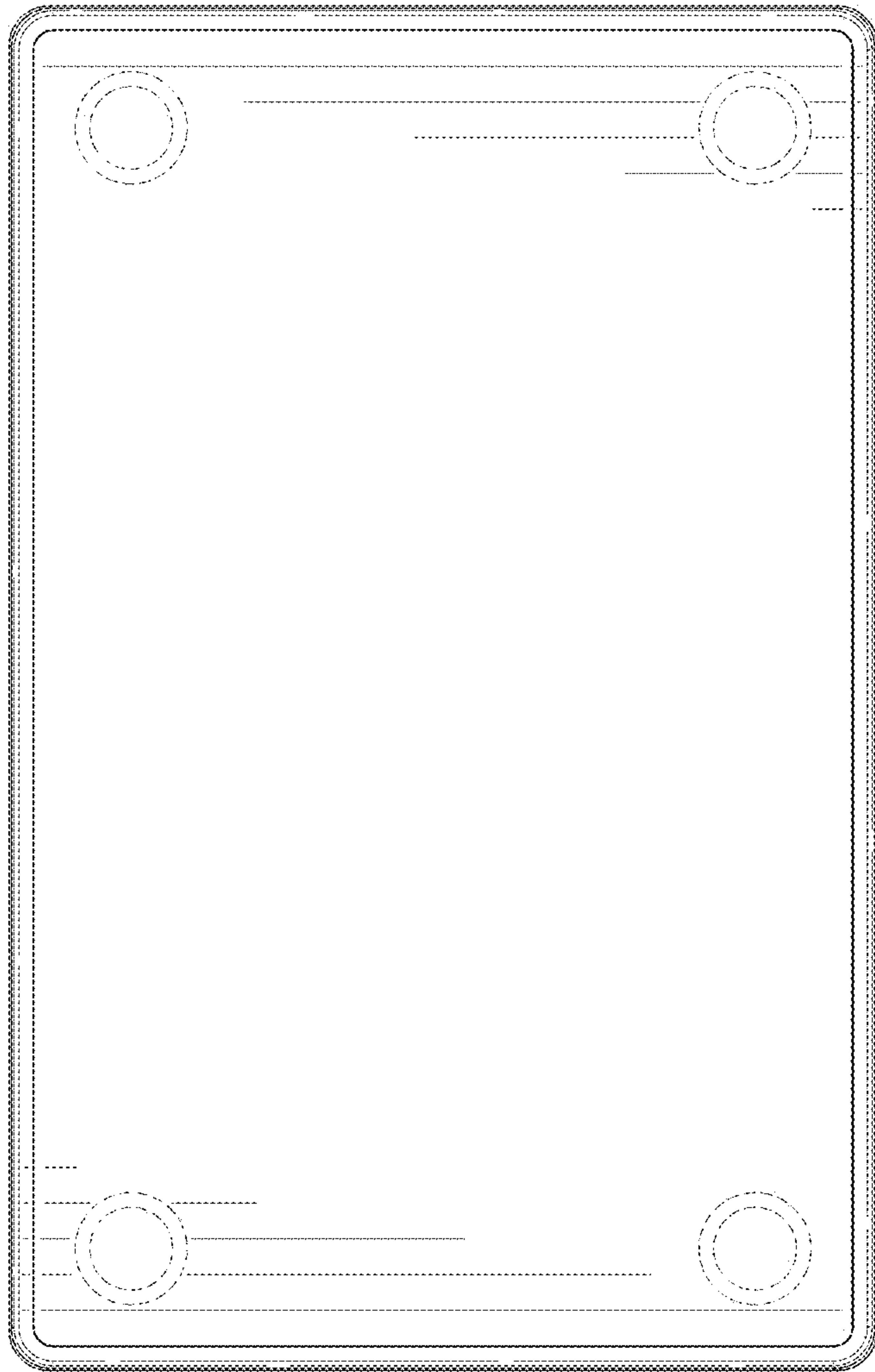

FIG. 8