



US00D981741S

(12) **United States Design Patent**
Schoonmaker et al.

(10) **Patent No.:** **US D981,741 S**
(45) **Date of Patent:** **** Mar. 28, 2023**

- (54) **GAMING MACHINE CHAIR**
- (71) Applicant: **ARISTOCRAT TECHNOLOGIES AUSTRALIA PTY LIMITED**, North Ryde (AU)
- (72) Inventors: **Rena Schoonmaker**, Las Vegas, NV (US); **Mathew Wion**, Las Vegas, NV (US); **Daniel Waller**, Reno, NV (US); **Wendell Davis, Jr.**, Reno, NV (US); **Edmond E. Abadie**, Reno, NV (US)
- (73) Assignee: **ARISTOCRAT TECHNOLOGIES AUSTRALIA PTY LIMITED**, North Ryde (AU)
- (**) Term: **15 Years**
- (21) Appl. No.: **29/708,718**
- (22) Filed: **Oct. 9, 2019**
- (51) **LOC (14) Cl.** **06-01**
- (52) **U.S. Cl.**
USPC **D6/364**
- (58) **Field of Classification Search**
USPC D6/334, 346, 349, 355, 360, 361, 362, D6/363, 364, 365, 366, 367, 368, 371, D6/372, 374, 375, 379, 380, 716.4
CPC A47C 3/00; A47C 3/12; A47C 3/20; A47C 3/32; A47C 1/00; A47C 1/022; A47C 1/024; A47C 1/04; A47C 1/06; A47C 7/24; A47C 7/36; A47C 7/46; A47C 7/18; A47C 7/40; A47C 17/02
See application file for complete search history.

- D344,296 S 2/1994 Mckay
 - 5,310,152 A 5/1994 O'Neill
 - D376,391 S 12/1996 Okumara
 - 5,676,231 A 10/1997 Legras
 - D411,582 S 6/1999 Muraki
 - 5,993,317 A 11/1999 Majima
- (Continued)

FOREIGN PATENT DOCUMENTS

- AU 2001051810 A1 12/2001
 - CA 178255 11/2018
- (Continued)

OTHER PUBLICATIONS

Flappy Bird arcade cabinet will empty your wallet in record time, Fingas, Jan. 10, 2015, retrieved from <https://www.engadget.com/2015/01/10/flappy-bird-arcade-cabinet/>.

(Continued)

Primary Examiner — R. Johnson
(74) *Attorney, Agent, or Firm* — Armstrong Teasdale LLP

(57) **CLAIM**

We claim the ornamental design for a gaming machine chair, as shown and described.

DESCRIPTION

FIG. 1 is a perspective view of a first embodiment of a gaming machine chair showing the new design;
FIG. 2 is a front view thereof;
FIG. 3 is a rear view thereof;
FIG. 4 is a right side view thereof;
FIG. 5 is a left side view thereof;
FIG. 6 is a top view thereof; and,
FIG. 7 is a bottom view thereof.

In these drawings, the broken lines illustrate the portions of the gaming machine chair that form no part of the claimed design.

1 Claim, 7 Drawing Sheets

(56) **References Cited**

U.S. PATENT DOCUMENTS

- D77,825 S 2/1929 Fey
- D139,949 S 1/1945 Haggstrom
- D245,359 S 8/1977 Wilke
- 4,084,194 A 4/1978 Hector
- D321,095 S * 10/1991 Bockwoldt D6/356

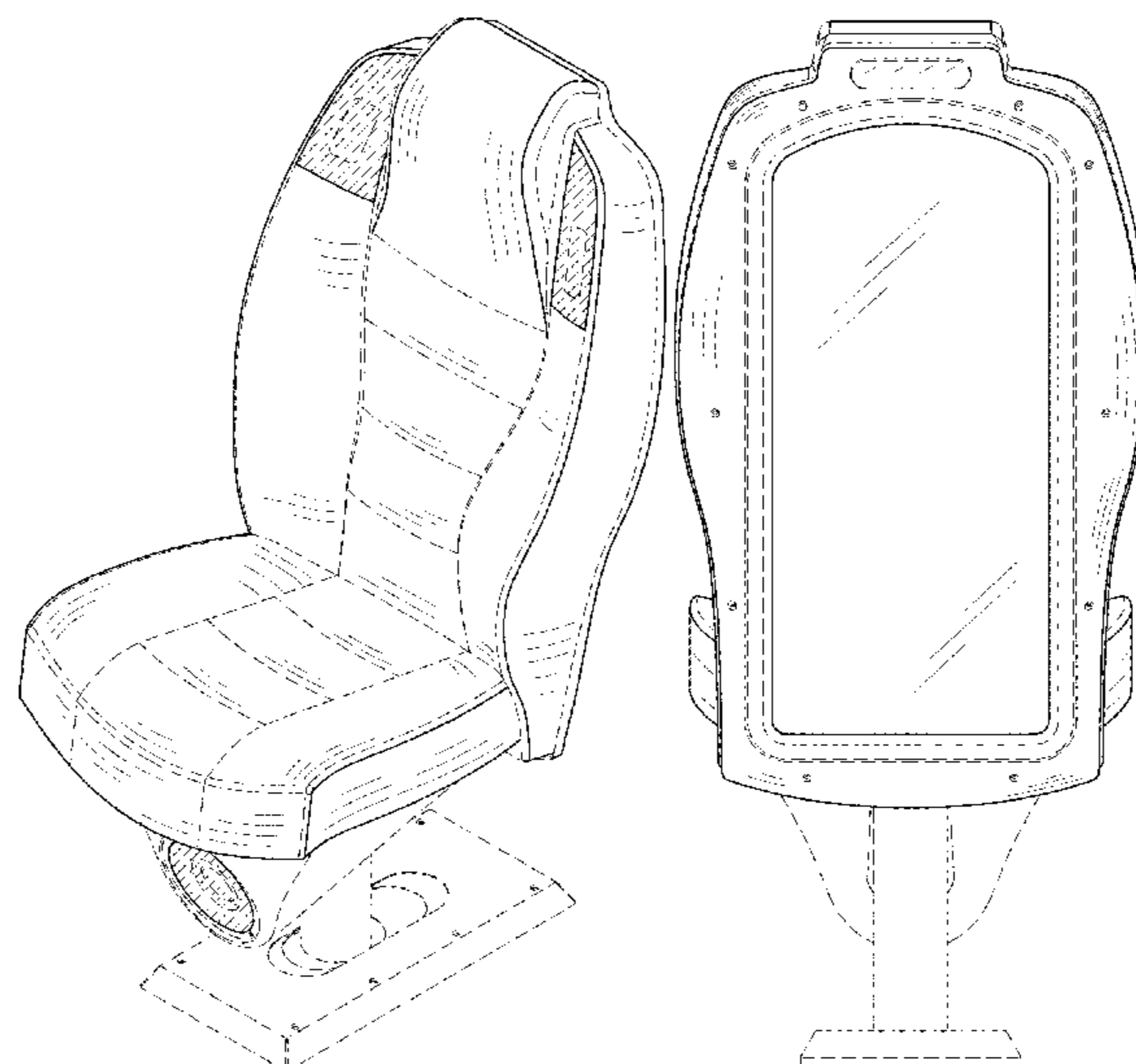

(56)

References Cited

U.S. PATENT DOCUMENTS

D421,631 S 3/2000 Tsuda
 D460,915 S 7/2002 Lynch
 6,464,586 B1 10/2002 Kamata
 D467,977 S 12/2002 Gatto
 6,530,842 B1 3/2003 Wells
 6,749,515 B2 6/2004 Hedrick
 6,976,919 B2 12/2005 Cole
 7,044,423 B2 5/2006 Bober
 D537,482 S 2/2007 Gadda
 7,267,613 B2 9/2007 Cole
 D562,576 S * 2/2008 Ritzel D6/356
 7,533,762 B2 5/2009 Kuttel
 D594,068 S 6/2009 Hsu
 7,832,799 B2 11/2010 Davis, Jr. et al.
 8,012,027 B2 9/2011 Mcgahn
 8,083,458 B2 12/2011 Wilkie
 8,113,517 B2 2/2012 Canterbury
 D658,721 S 5/2012 Yang
 8,210,949 B2 7/2012 Graf
 8,366,555 B2 2/2013 Mcgahn
 8,419,550 B2 4/2013 Anthony
 8,444,482 B2 5/2013 Aoki
 8,576,553 B2 11/2013 Myerchin
 D704,273 S 5/2014 Chudek
 D706,741 S 6/2014 Myers
 8,740,188 B1 6/2014 Foster
 8,747,225 B2 6/2014 Canterbury et al.
 8,858,343 B2 10/2014 Filipour et al.
 8,894,487 B2 11/2014 Granger et al.
 8,986,109 B2 3/2015 Graf
 D740,887 S 10/2015 Randazzo
 9,756,941 B1 9/2017 Rowland
 D802,676 S 11/2017 Steelman
 D808,467 S 1/2018 Huang
 9,858,750 B2 1/2018 Kovacs
 D812,145 S 3/2018 Huang
 D818,048 S 5/2018 Calhoun
 D820,915 S 6/2018 Lee
 D833,535 S 11/2018 Lim
 D839,357 S 1/2019 Steelman
 D842,929 S 3/2019 Hung
 D843,463 S 3/2019 Castro
 D843,465 S 3/2019 Castro
 D843,472 S 3/2019 Castro
 D843,476 S 3/2019 Lesley
 D843,479 S 3/2019 Castro
 D844,062 S 3/2019 Lesley
 D847,905 S 5/2019 Lewis
 D849,149 S 5/2019 Bussey
 10,287,148 B2 5/2019 Urban
 D852,890 S 7/2019 Ross
 D864,305 S 10/2019 Ortiz De Viveiros
 10,445,977 B2 10/2019 Tovar
 D866,666 S 11/2019 Ditton
 D867,461 S 11/2019 Huang
 D868,716 S 12/2019 Hodgson
 10,573,118 B2 2/2020 Goldstein
 D887,496 S 6/2020 Urban
 D889,546 S 7/2020 Jones
 D889,547 S 7/2020 Jones
 D890,848 S 7/2020 Johnson
 10,716,224 B2 7/2020 Dunn
 D904,098 S * 12/2020 Le D6/334
 D905,172 S 12/2020 Boese
 D907,124 S 1/2021 Demarco
 D907,708 S 1/2021 Demarco
 D907,709 S 1/2021 Demarco
 D908,171 S 1/2021 Demarco
 D908,173 S 1/2021 Demarco
 D909,479 S 2/2021 Abele
 D909,491 S 2/2021 Demarco
 D910,119 S 2/2021 Demarco
 D910,763 S 2/2021 Demarco
 D911,055 S * 2/2021 Wang D6/366
 D911,724 S 3/2021 Waller et al.

D911,992 S 3/2021 Stinson
 D913,379 S 3/2021 Calhoun
 D915,093 S * 4/2021 Shen D6/366
 D917,621 S 4/2021 Kaminkow
 D918,300 S 5/2021 Demarco
 D918,303 S 5/2021 Demarco
 D918,850 S 5/2021 Shim
 D918,852 S 5/2021 Shim
 D919,010 S 5/2021 Bussey
 D919,585 S 5/2021 Shim
 D919,586 S 5/2021 Lim
 D920,323 S 5/2021 Lee
 D921,762 S 6/2021 Hodgson
 11,151,833 B2 10/2021 Hemerick
 2002/0198034 A1 12/2002 Wang
 2005/0109892 A1 5/2005 Bober
 2005/0277477 A1 12/2005 Hajder
 2006/0205504 A1 9/2006 Okada
 2007/0099708 A1 5/2007 Okada
 2008/0055491 A1 3/2008 Gordon
 2008/0087521 A1 4/2008 Cole
 2008/0113740 A1 5/2008 Mcgahn
 2008/0113768 A1 5/2008 Baerlocher
 2008/0113820 A1 5/2008 Tedsen
 2008/0254862 A1 10/2008 Mattice
 2008/0254881 A1 10/2008 Lutnick
 2009/0280911 A1 11/2009 Tsao
 2010/0120530 A1 5/2010 Lesley
 2013/0035159 A1 2/2013 Cornell
 2015/0336491 A1 * 11/2015 Abe B60N 2/643
 297/452.48
 2017/0039812 A1 2/2017 Baron
 2018/0053373 A1 2/2018 Goldstein
 2018/0075707 A1 3/2018 Hirai
 2018/0190068 A1 7/2018 Priddy
 2019/0012874 A1 1/2019 Goldstein
 2019/0046872 A1 2/2019 Glenn, II
 2019/0096161 A1 3/2019 Barbour
 2019/0096169 A1 3/2019 Tovar
 2019/0096170 A1 3/2019 Lewis
 2019/0096174 A1 3/2019 Ambrecht
 2019/0099000 A1 4/2019 Waller et al.
 2019/0254433 A1 * 8/2019 Smit A47C 4/028

FOREIGN PATENT DOCUMENTS

DE 0015402120001 6/2009
 DE 0015402380001 8/2009
 DE 0028613360001 11/2015
 EP 1778375 5/2007
 JP 1101243 2/2001
 JP 2002263262 A 9/2002
 JP 1484230 10/2013
 WO 2005094957 A1 10/2005

OTHER PUBLICATIONS

World's Largest Pac-Man Game Overview, Bandai Namco, Jul. 11, 2016, retrieved from https://www.youtube.com/watch?time_continue=54&v=4GqS9TTecGc.
 Ice Debuts Shell Game Addition to Price is Right Redemption Lineup, Montano, Jun. 5, 2011, retrieved from [https://www.vendingtimes.\(X\)m/articles/ice-debuts-shell-game-addition-to-price-is-right-r-8412?id=5FF3782D18934396BD83A14B3BD1E0BC](https://www.vendingtimes.(X)m/articles/ice-debuts-shell-game-addition-to-price-is-right-r-8412?id=5FF3782D18934396BD83A14B3BD1E0BC).
 SD Ped pro, Xtension, Sep. 28, 2014, retrieved from <http://www.xtensiongaming.com/products/xtension-sit-down-pedestal-arcade-cabineet-for-fight-sticks/attachment/sd-ped-pro/>.
 Incredible Technologies Details Golden Tee Live 2012, Arcadehero, Aug. 25, 2011, retrieved from <http://arcadeheroes.com/2011/08/25/incredible-technologies-details-golden-tee-live-2012/>.
 Novomatic to showcase latest products at Peru Gaming Show, Jun. 2, 2016, retrieved from <http://www.innovategaming.com/c63114>.
 Introductie Fazi Roulette, Elam Group, Jun. 10, 2018, retrieved from <https://www.youtube.com/watch?v=RLrFI5QDT5U>.
 Office Action dated Mar. 25, 2020, for U.S. Appl. No. 29/658,892 (pp. 1-10).

(56)

References Cited

OTHER PUBLICATIONS

Office Action dated Sep. 18, 2020 for U.S. Appl. No. 29/658,892 (pp. 1-5).

Notice of Allowance dated Dec. 31, 2020 for U.S. Appl. No. 29/658,892 (pp. 1-5).

Notice of Allowance dated Jul. 8, 2021 for U.S. Appl. No. 29/768,121 (pp. 1-10).

Office Action dated Apr. 29, 2021 for U.S. Appl. No. 16/867,290 (pp. 1-12).

Notice of Allowance dated Aug. 5, 2021 for U.S. Appl. No. 16/867,290 (pp. 1-7).

Notice of Allowance dated Nov. 1, 2021 for U.S. Appl. No. 16/867,290 (pp. 1-7).

Office Action dated Jan. 7, 2022 for U.S. Appl. No. 29/696,682 (pp. 1-8).

Office Action dated Apr. 18, 2022 for U.S. Appl. No. 29/696,682 (pp. 1-6).

Office Action (Non-Final Rejection) dated Jun. 22, 2022 for U.S. Appl. No. 17/384,199 (pp. 1-9).

Office Action dated Aug. 4, 2022 for U.S. Appl. No. 29/716,520 (pp. 1-6).

* cited by examiner

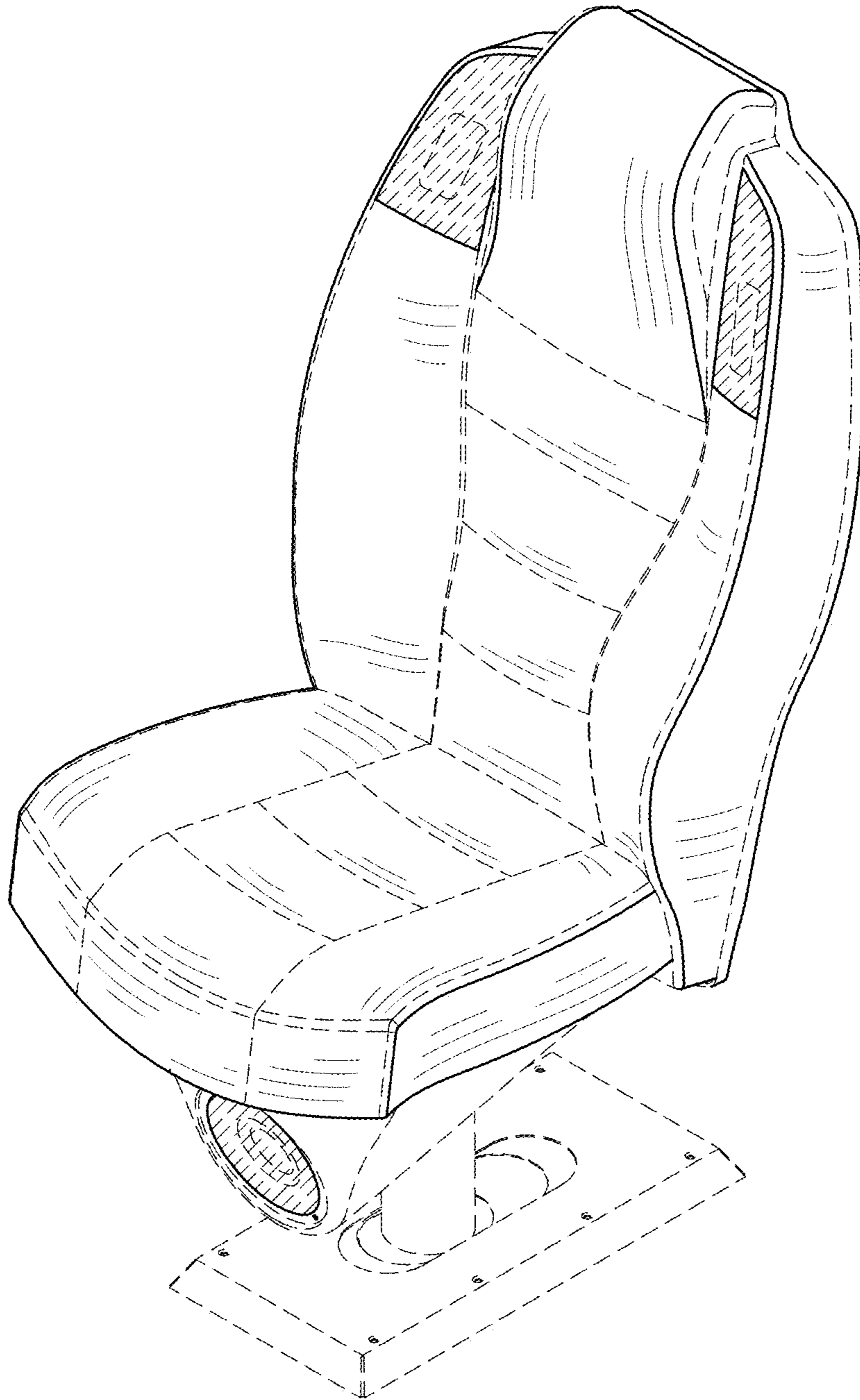

FIG. 1

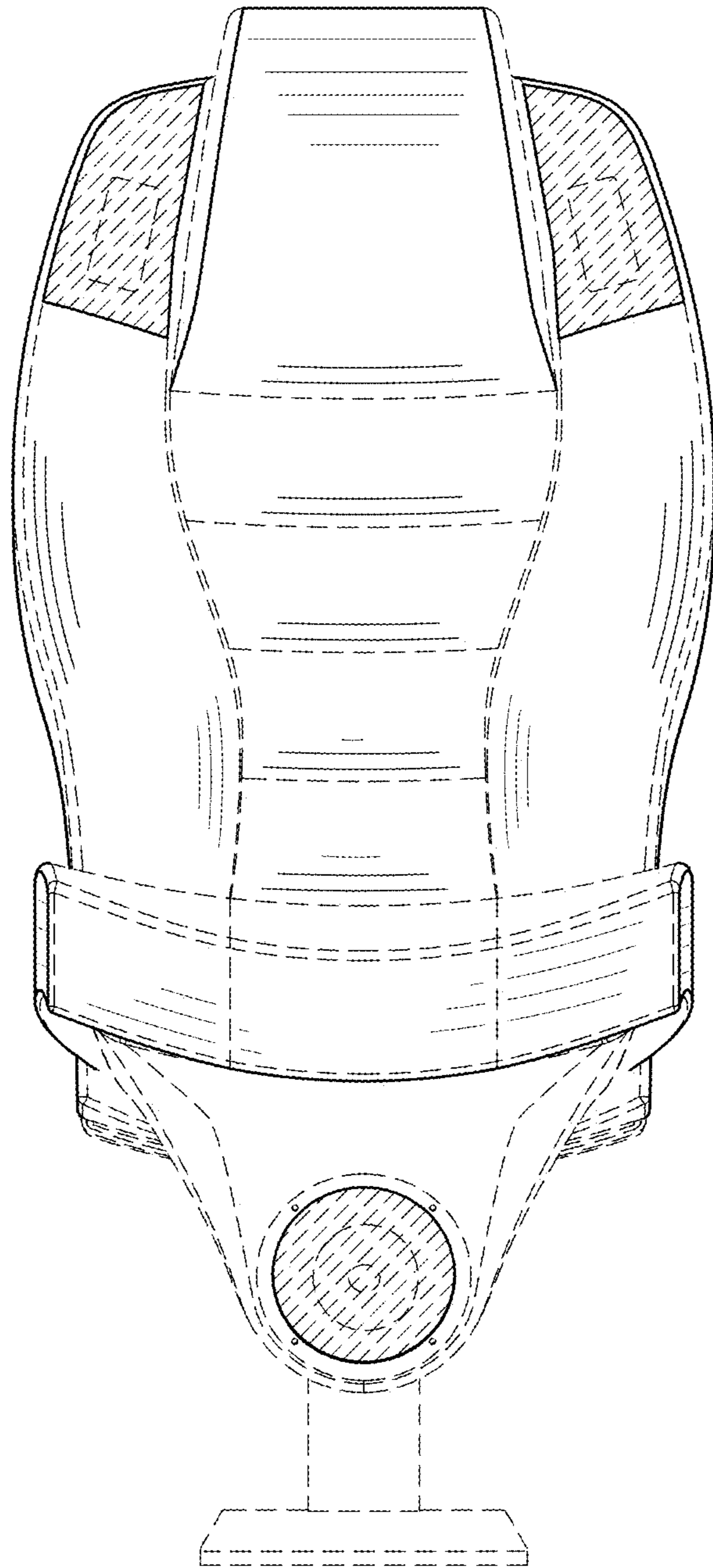

FIG. 2

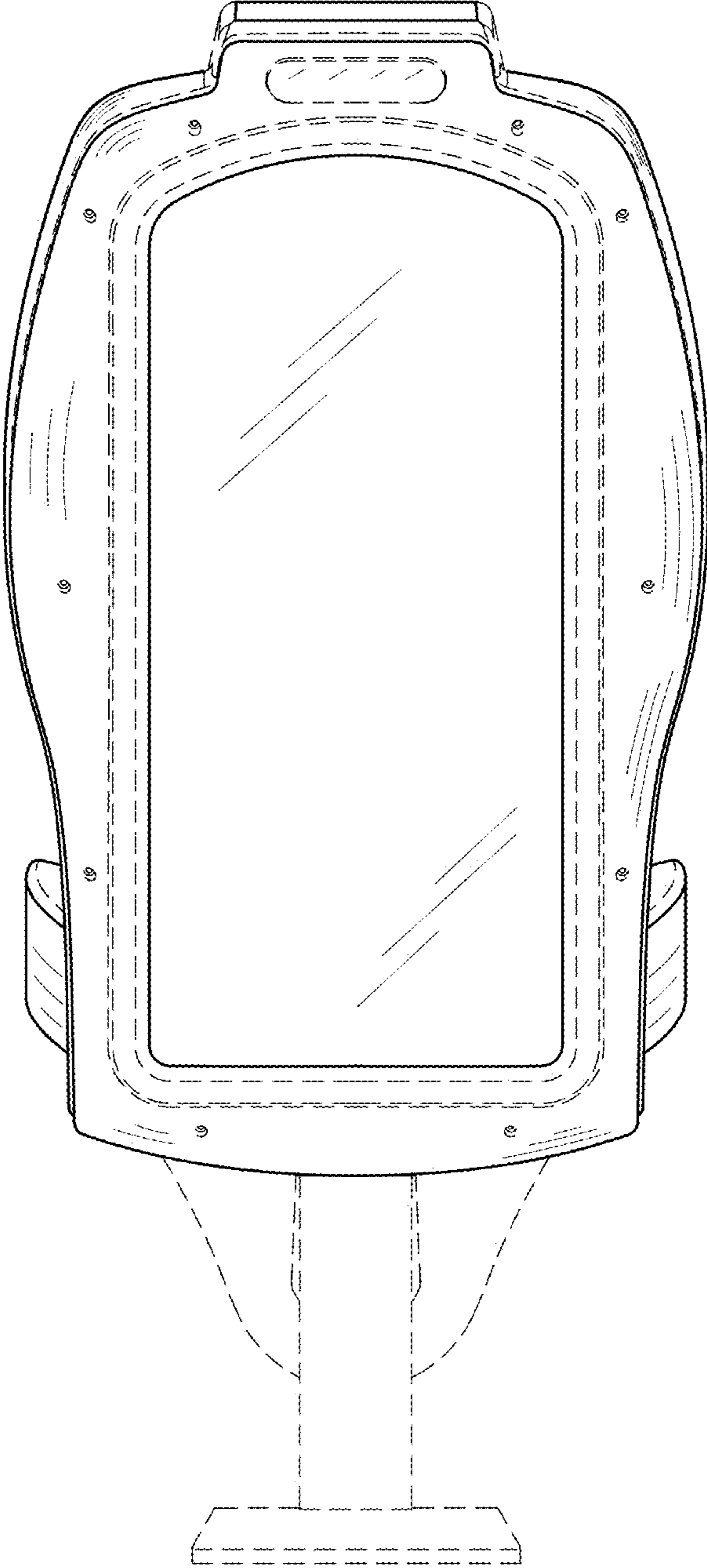

FIG. 3

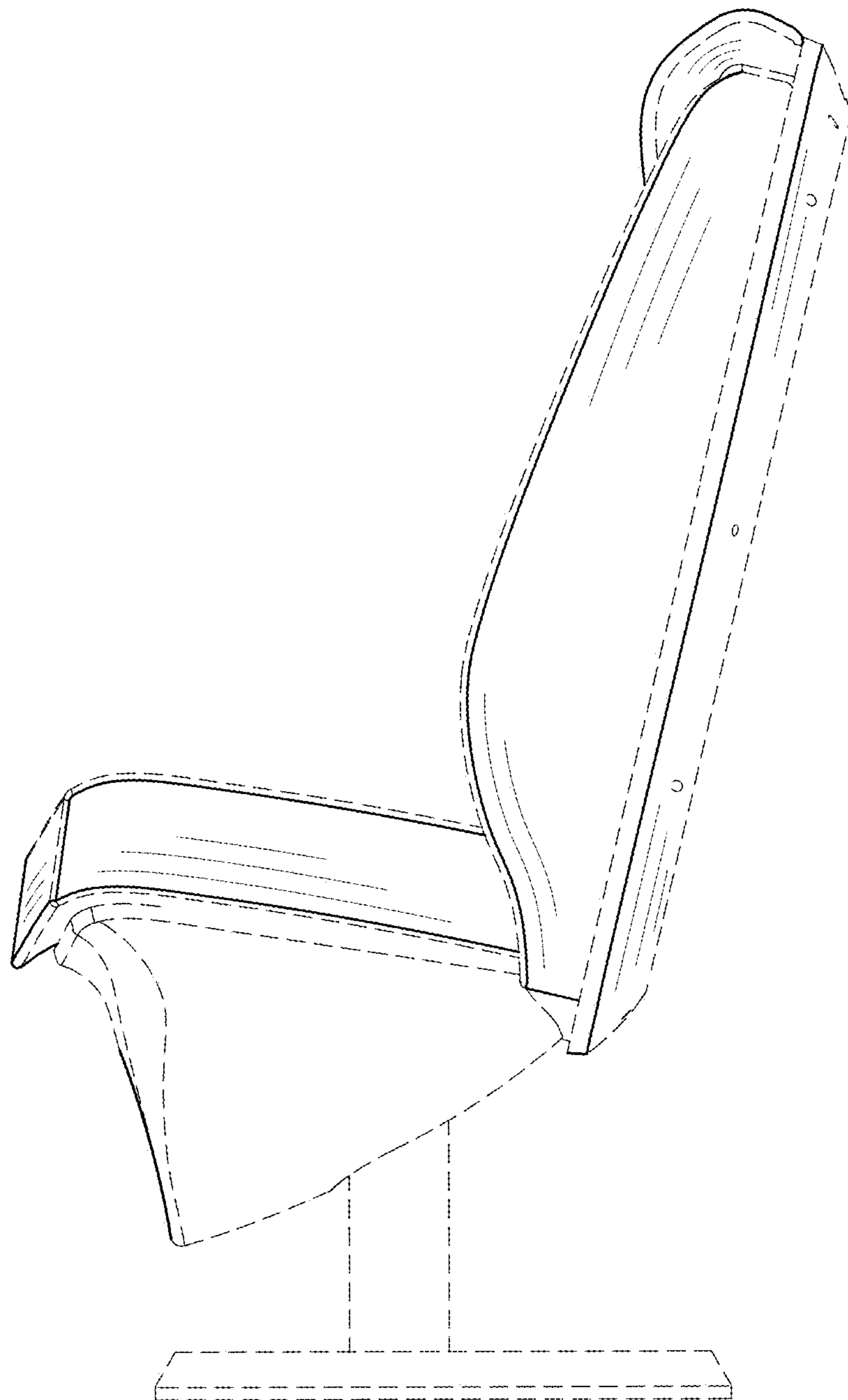

FIG. 4

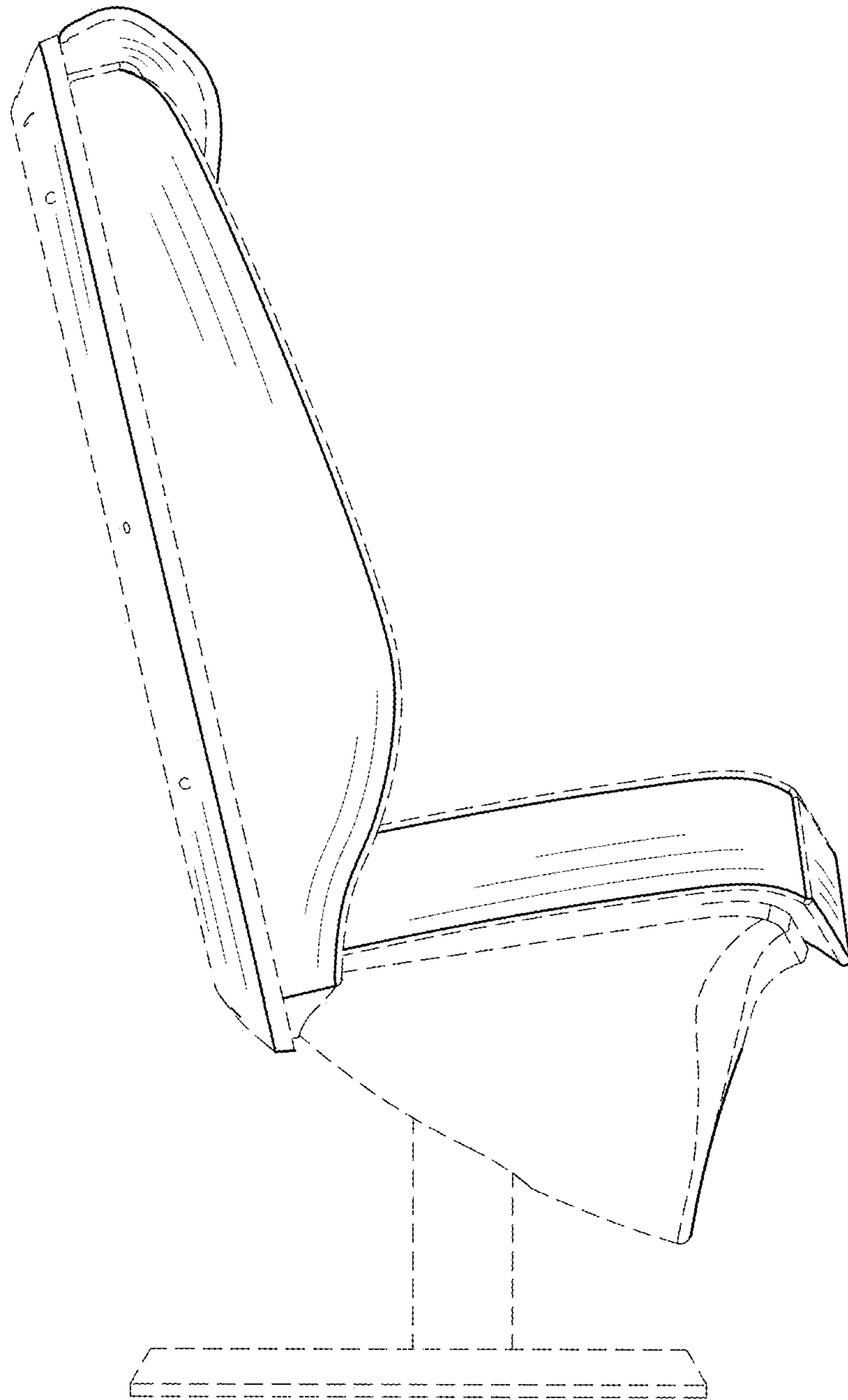

FIG. 5

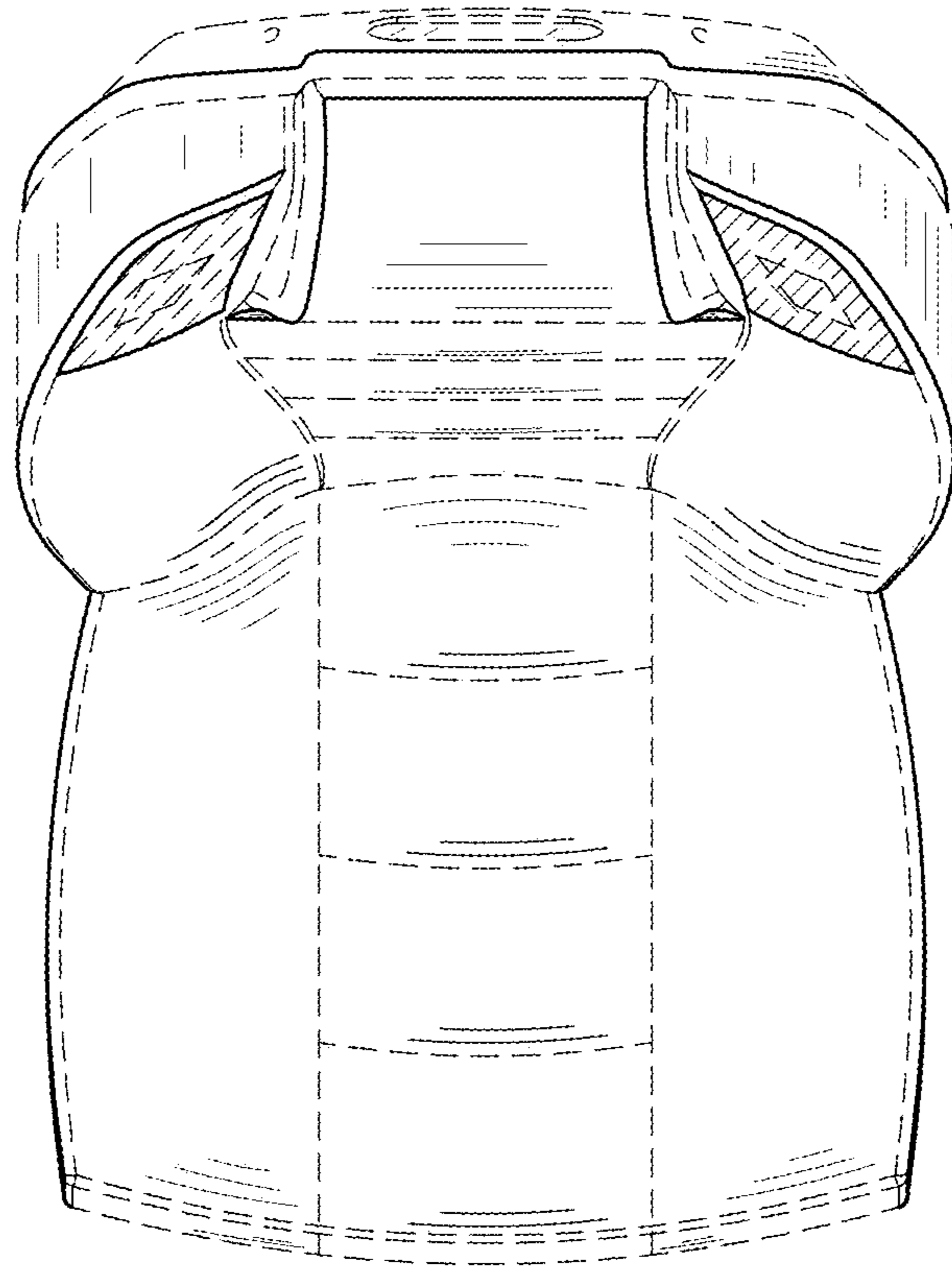

FIG. 6

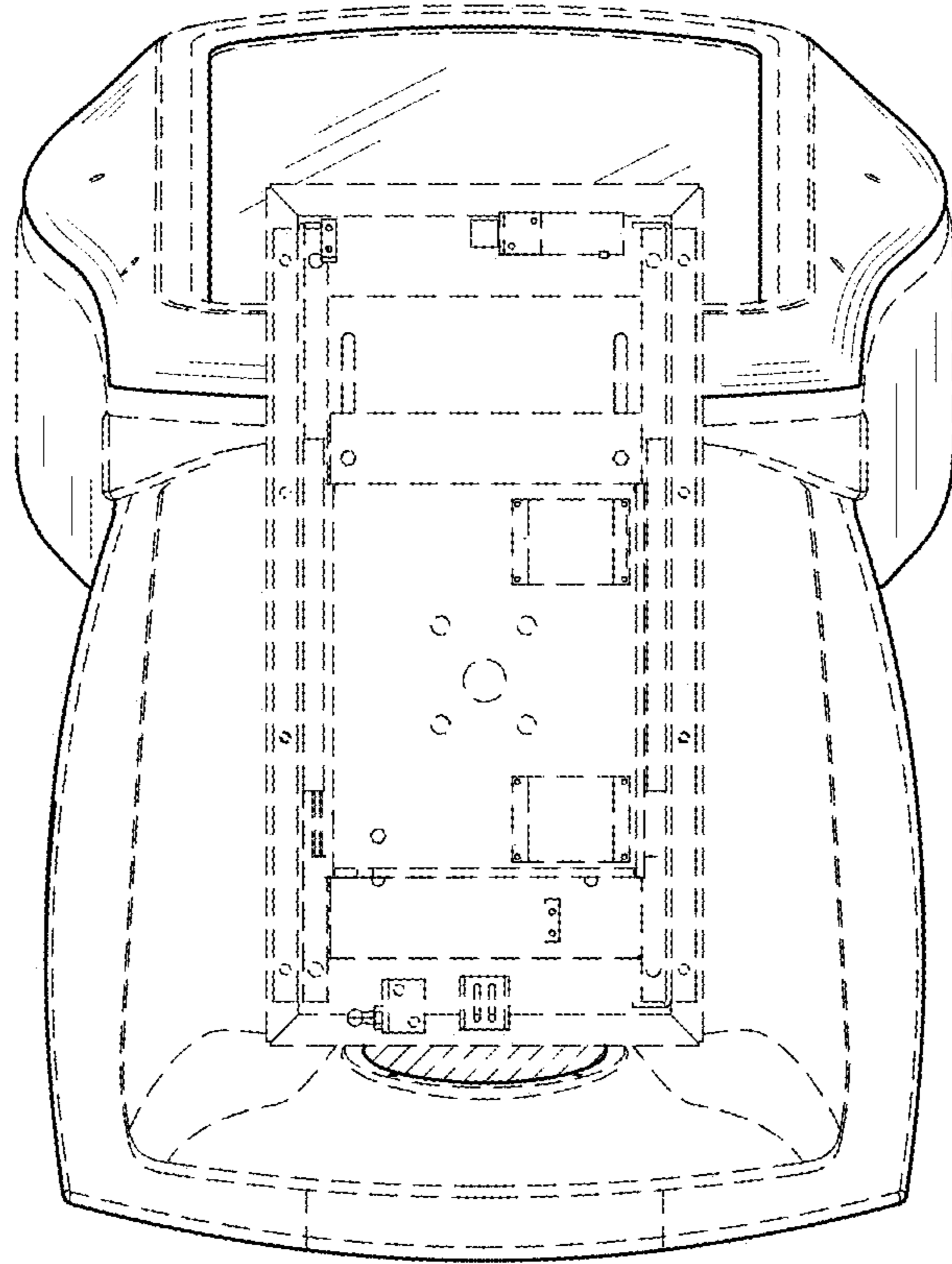

FIG. 7