



US00D981655S

(12) **United States Design Patent**
Tsou

(10) **Patent No.:** **US D981,655 S**
(45) **Date of Patent:** **** Mar. 21, 2023**

(54) **HORSE SPUR**

(71) Applicant: **R & G Equipment NV**, Malle (BE)

(72) Inventor: **Meng-Hao Tsou**, Malle (BE)

(73) Assignee: **R & G Equipment NV**, Malle (BE)

(**) Term: **15 Years**

(21) Appl. No.: **29/730,049**

(22) Filed: **Apr. 1, 2020**

(30) **Foreign Application Priority Data**

Oct. 4, 2019	(EM)	006974333-0001
Oct. 4, 2019	(EM)	006974333-0002
Oct. 4, 2019	(EM)	006974333-0003
Oct. 4, 2019	(EM)	006974333-0004

(51) **LOC (14) Cl.** **30-05**

(52) **U.S. Cl.**
USPC **D30/157**

(58) **Field of Classification Search**
USPC D30/157; D2/642, 946, 976
CPC A43C 17/02; A43C 17/04; A43C 17/06
See application file for complete search history.

(56) **References Cited**

U.S. PATENT DOCUMENTS

2,454,228	A *	11/1948	Smith	A43C 17/02
				446/26
2,907,161	A *	10/1959	Chandler	A43C 17/02
				54/83.1
3,157,013	A *	11/1964	Hayward	A43C 17/02
				54/49.5
3,953,958	A *	5/1976	Beaston	A43C 17/02
				54/83.2
4,642,910	A *	2/1987	Carter, Jr.	A43C 17/04
				359/518
D289,809	S *	5/1987	Pela	D30/157
D383,257	S *	9/1997	Clark	D30/157
5,913,800	A *	6/1999	Williams	A43C 17/00
				54/83.1

(Continued)

OTHER PUBLICATIONS

“LamiCell: Metalab Spur with Internal Rubber Grip”. Found online Dec. 14, 2021 at facebook.com. Reference dated Jan. 28, 2021. Retrieved from https://www.facebook.com/lamicell1998/photos/a.413145845491531/1905770572895710/?type=3.*

(Continued)

Primary Examiner — Kendra Leslie Hamilton

(74) *Attorney, Agent, or Firm* — Fresh IP PLC; Clifford D. Hyra; Aubrey Y. Chen

(57) **CLAIM**

The ornamental design for a horse spur, as shown and described.

DESCRIPTION

FIG. 1 is a front elevation view of a horse spur, in a first embodiment;
FIG. 2 is a rear elevation view thereof;
FIG. 3 is a left side elevation view thereof;
FIG. 4 is a right side elevation view thereof;
FIG. 5 is an enlarged, left side elevation view of the horse spur rowel of FIG. 1, shown separately for clarity of disclosure;
FIG. 6 is a front elevation view of a horse spur, in a second embodiment;
FIG. 7 is a rear elevation view thereof;
FIG. 8 is a left side elevation view thereof;
FIG. 9 is a right side elevation view thereof; and,
FIG. 10 is an enlarged, left side elevation view of the horse spur rowel of FIG. 6, shown separately for clarity of disclosure.
The broken lines in the drawings are included for the purpose of illustrating subject matter that forms no part of the claimed design.

1 Claim, 10 Drawing Sheets

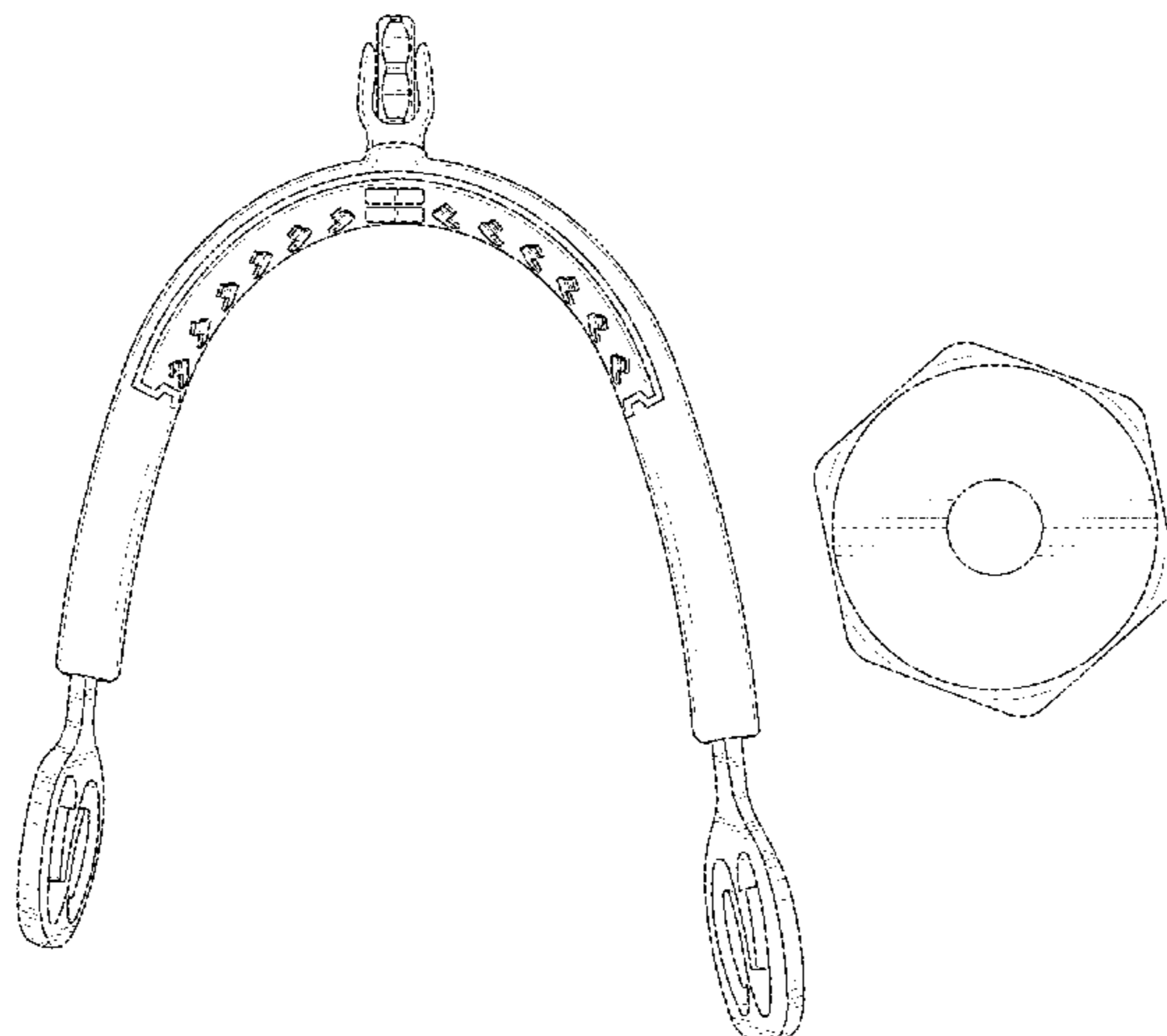

(56)

References Cited

U.S. PATENT DOCUMENTS

D689,268 S * 9/2013 Dawson D2/918
D915,691 S * 4/2021 Williams D30/157
2008/0016828 A1* 1/2008 Strauss A43C 17/04
54/83.2
2009/0064641 A1* 3/2009 Wetherell A43C 17/00
54/83.1
2012/0266575 A1* 10/2012 Chang A43C 17/02
54/83.1

OTHER PUBLICATIONS

“LamiCell: Metalab Spur with Rubber Hexagonal Rowel”. Found online Dec. 14, 2021 at rglamicell.com. Reference dated Dec. 14, 2021. Retrieved from <https://rglamicell.com/product/metalab-ss-spur-with-rubber-hexagon-rowel/>.*

“R&G Equipment Business Information: Relationship Shown to Lamicell”. Found online Dec. 14, 2021 at gb.kompass.com. Reference dated Aug. 29, 2021. Retrieved from <https://gb.kompass.com/c/r-g-equipment-nv/be0340443/>.*

“Intrepid International: Western Show Spur with Brass Rowel”. Found online Feb. 4, 2022 at [amazon.com](https://www.amazon.com). Reference dated Apr. 11, 2012. Retrieved from <https://www.amazon.com/Intrepid-International-Black-Western-Brass/dp/B003PBQ9GA/>.*

* cited by examiner

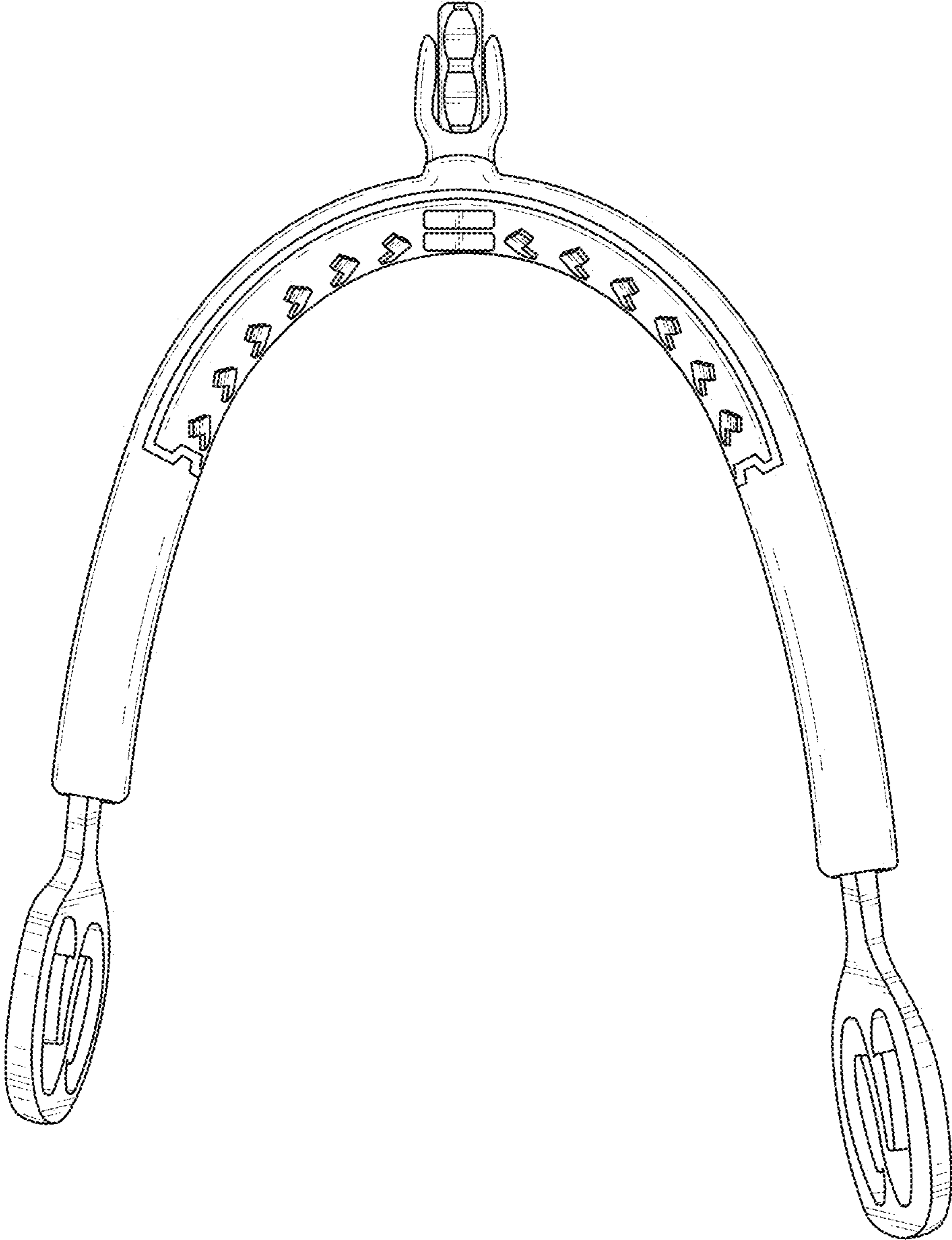

FIG. 1

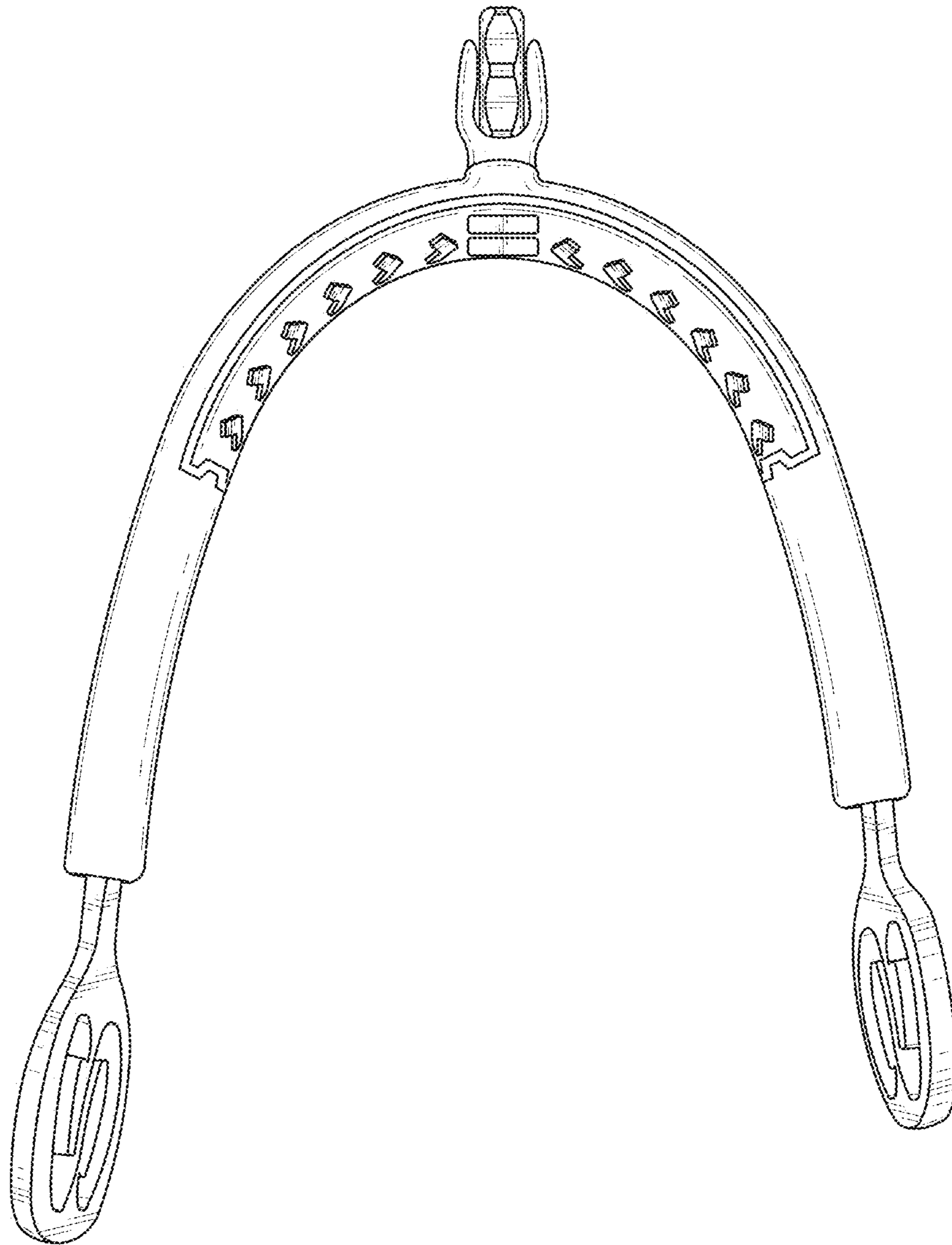

FIG. 2

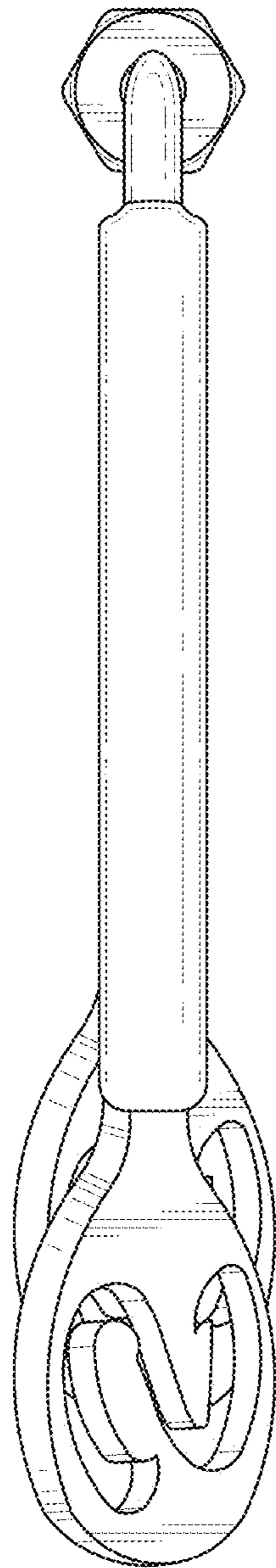

FIG. 3

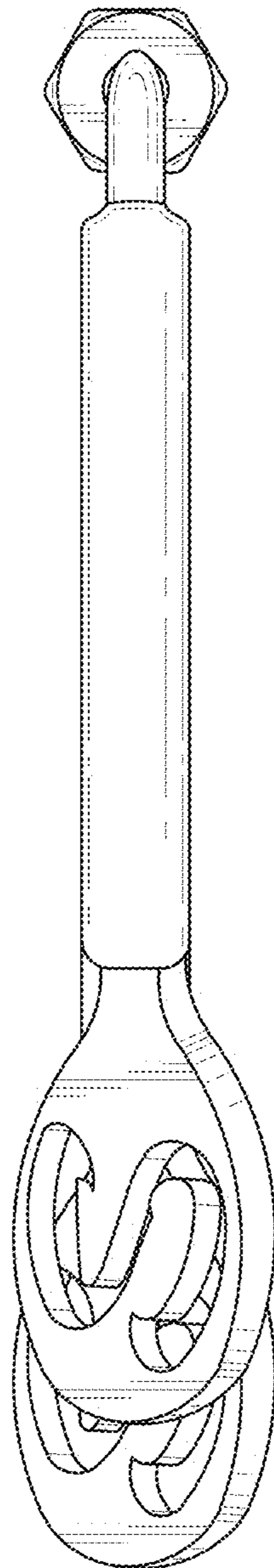

FIG. 4

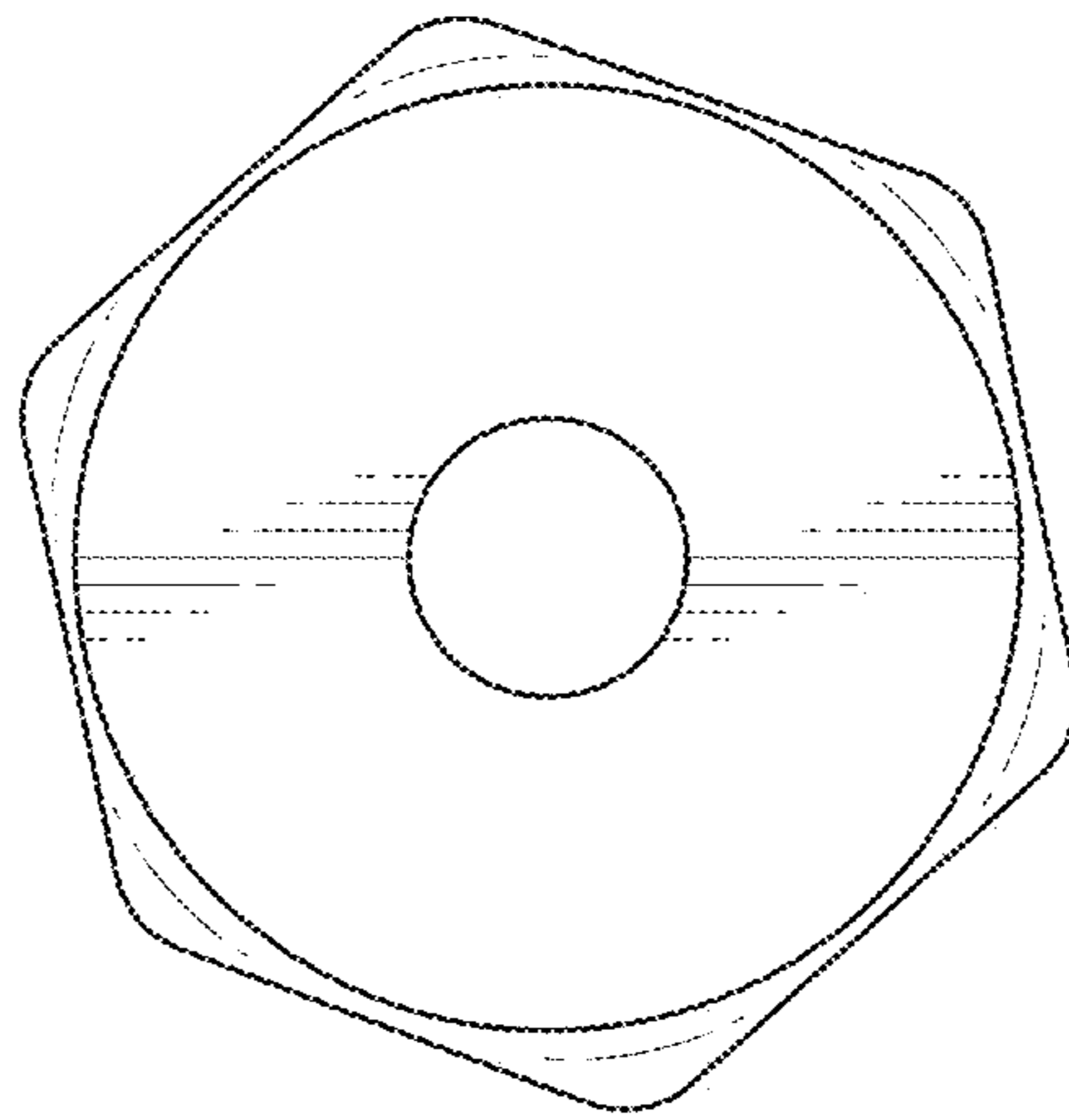

FIG. 5

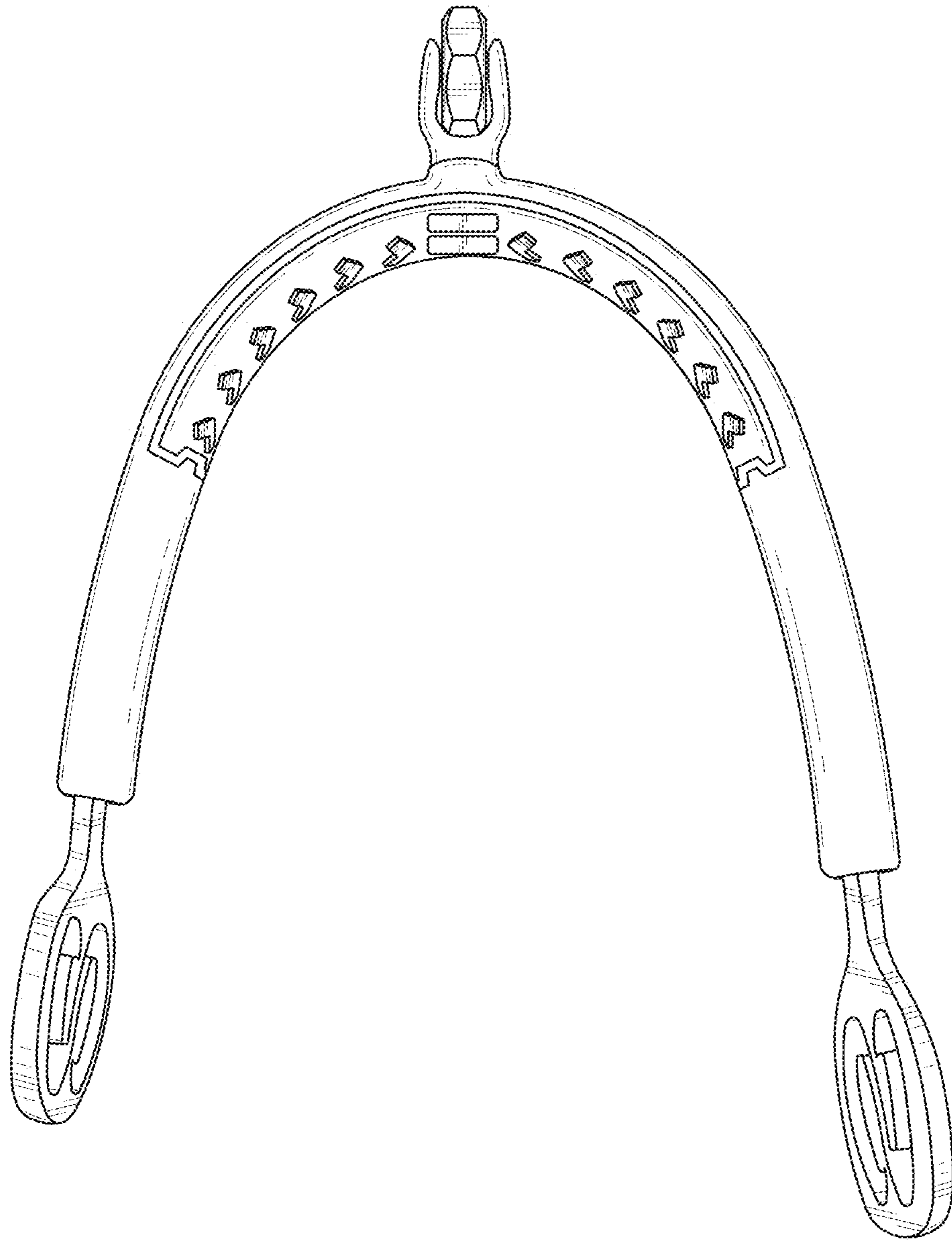

FIG. 6

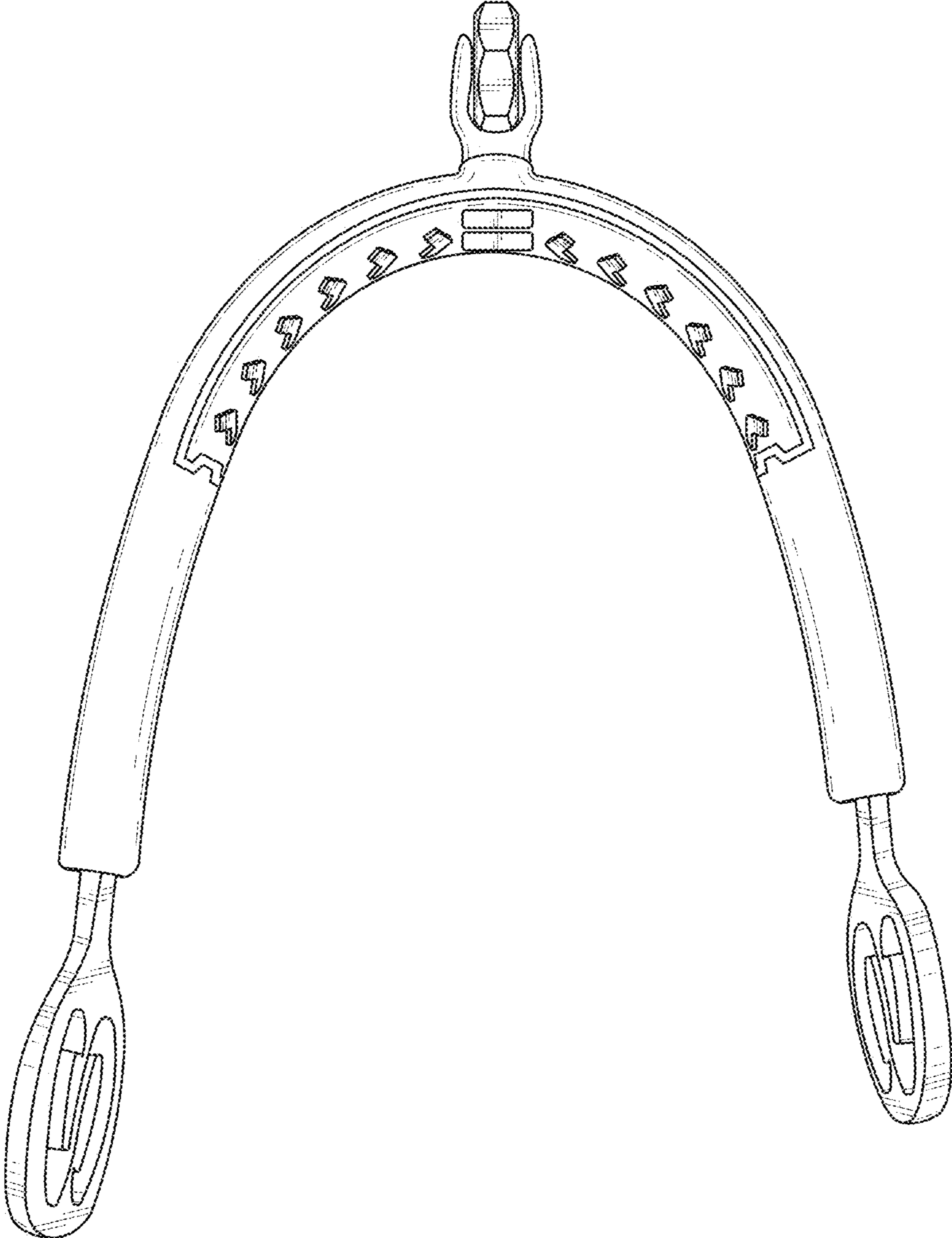

FIG. 7

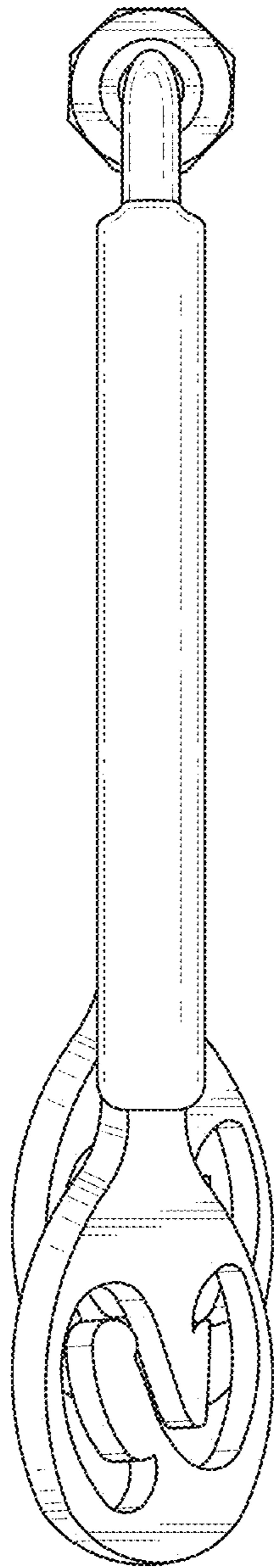

FIG. 8

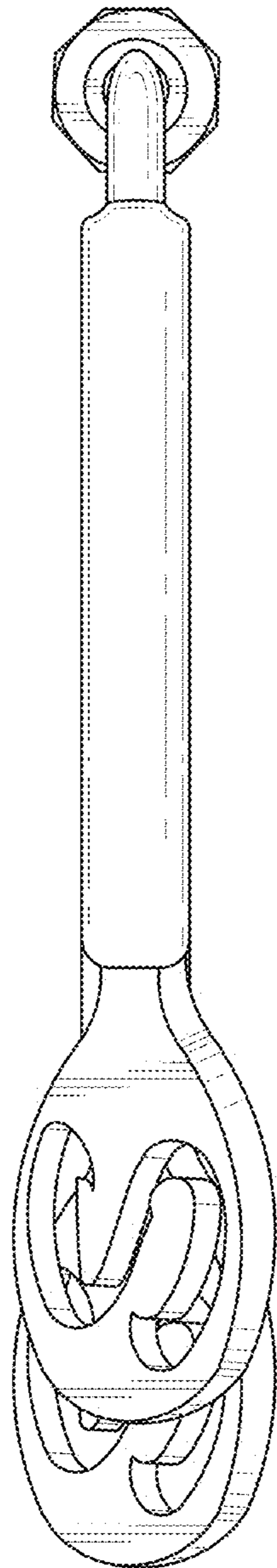

FIG. 9

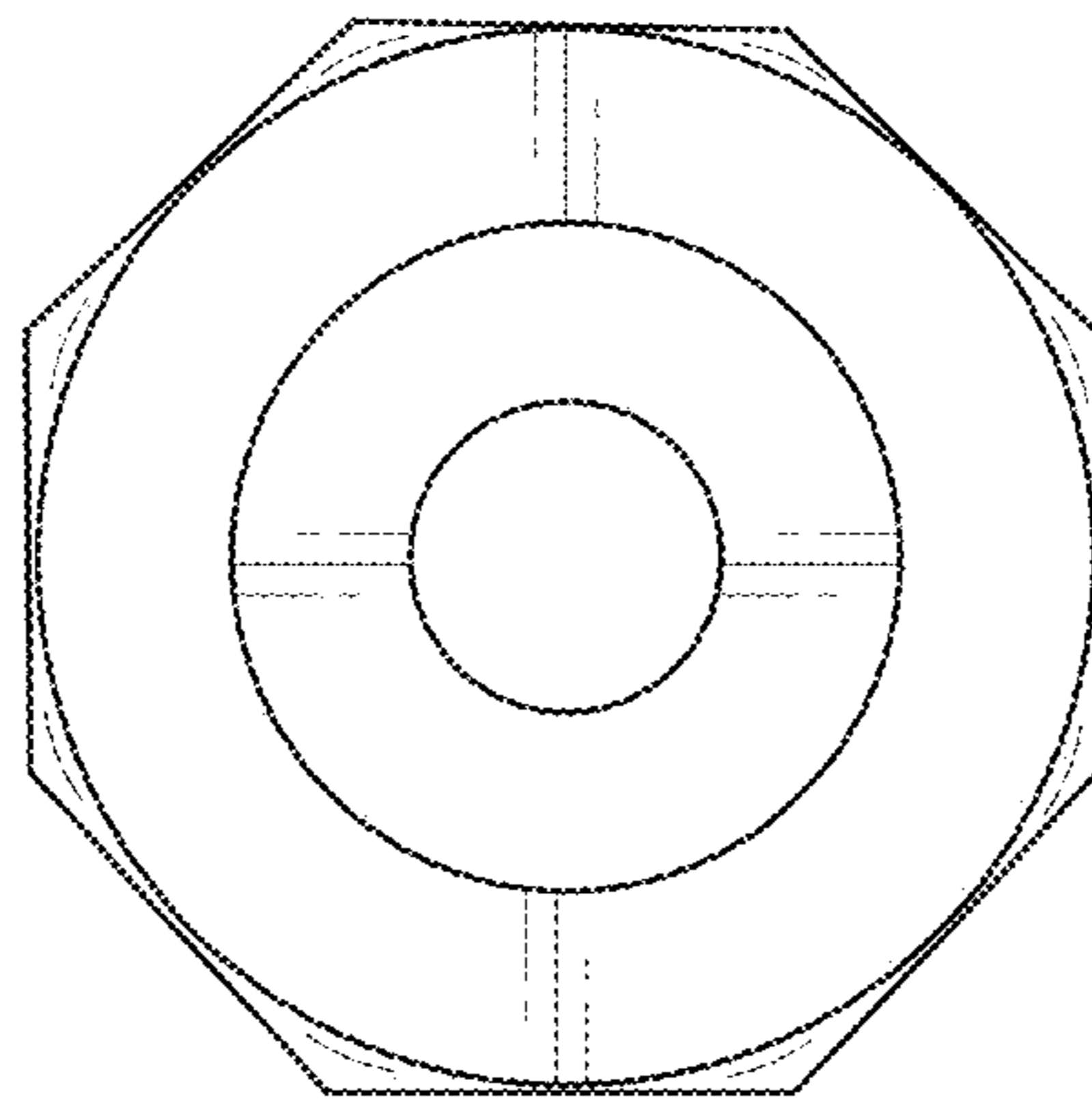

FIG. 10