



US00D981573S

(12) **United States Design Patent**  
**Larsen**

(10) **Patent No.:** **US D981,573 S**  
(45) **Date of Patent:** **\*\* Mar. 21, 2023**

(54) **PACIFIER FOR BABY**

(71) Applicant: **AH License ApS**, Hillerød (DK)

(72) Inventor: **Henrik Larsen**, Hillerød (DK)

(\*\*) Term: **15 Years**

(21) Appl. No.: **35/513,824**

(22) Filed: **Feb. 18, 2022**

(80) **Hague Agreement Data**

Int. Filing Date: **Feb. 18, 2022**  
Int. Reg. No.: **DM/219413**  
Int. Reg. Date: **Feb. 18, 2022**  
Int. Reg. Pub. Date: **Mar. 18, 2022**

(30) **Foreign Application Priority Data**

Aug. 24, 2021 (WO) ..... WIPO107896

(51) **LOC (14) Cl.** ..... **24-04**

(52) **U.S. Cl.**  
USPC ..... **D24/195; D24/194**

(58) **Field of Classification Search**  
USPC ..... D24/115, 117, 190, 193, 194, 195, 214;  
D30/160; D21/576, 584, 596, 616, 611,  
D21/630; D11/215  
CPC ..... A61J 17/001; A61J 17/10; A61J 17/107;  
A61J 17/109; A61J 17/111; A61J  
17/1111; A61J 17/1115  
See application file for complete search history.

(56) **References Cited**

**U.S. PATENT DOCUMENTS**

3,825,014 A \* 7/1974 Wroten ..... A61J 17/001  
606/236  
5,954,749 A \* 9/1999 Fields ..... A61J 17/111  
606/234  
D548,847 S \* 8/2007 Dunn ..... D24/194  
8,133,259 B2 \* 3/2012 Roehrig ..... A61J 17/001  
606/234

9,144,532 B1 \* 9/2015 Renner ..... A61J 17/001  
D862,714 S \* 10/2019 Eaton ..... D24/194  
D907,785 S \* 1/2021 Warden ..... D24/194  
D952,872 S \* 5/2022 Park ..... D24/195  
D954,278 S \* 6/2022 Simon ..... D24/194  
D955,591 S \* 6/2022 Jensen ..... D24/194  
D959,001 S \* 7/2022 Wu ..... D24/195  
2001/0047189 A1 \* 11/2001 Griffith ..... A61J 17/101  
606/234

(Continued)

**OTHER PUBLICATIONS**

“Hevea: BumiBébé Round Pacifiers”. Found online Sep. 29, 2021 at heveaplanet.com. Reference dated Dec. 3, 2020. Retrieved from [https://web.archive.org/web/20201203195943/https://heveaplanet.com/products/bumi-bebe-pacifier-2-pack-pink-rose.\\*](https://web.archive.org/web/20201203195943/https://heveaplanet.com/products/bumi-bebe-pacifier-2-pack-pink-rose.*)

(Continued)

*Primary Examiner* — Kendra Leslie Hamilton

(57) **CLAIM**

The ornamental design for a pacifier for baby, as shown and described.

**DESCRIPTION**

1. Pacifier for baby  
FIG. 1.1 is a left elevation view of a pacifier for baby showing my new design;  
FIG. 1.2 is a right elevation view thereof;  
FIG. 1.3 is a top, front perspective view thereof;  
FIG. 1.4 is a top, front, left perspective view thereof;  
FIG. 1.5 a bottom plan view thereof;  
FIG. 1.6 is a top plan view thereof;  
FIG. 1.7 is a bottom, front perspective view thereof;  
FIG. 1.8 is a bottom, right perspective view thereof;  
FIG. 1.9 is a bottom, right perspective view thereof;  
FIG. 1.10 is a top, left perspective view thereof;  
FIG. 1.11 is a bottom, front perspective view thereof; and  
FIG. 1.12 is a top, left perspective view thereof.  
The design shows the shape and ornamentation of a pacifier for babies.

**1 Claim, 12 Drawing Sheets**

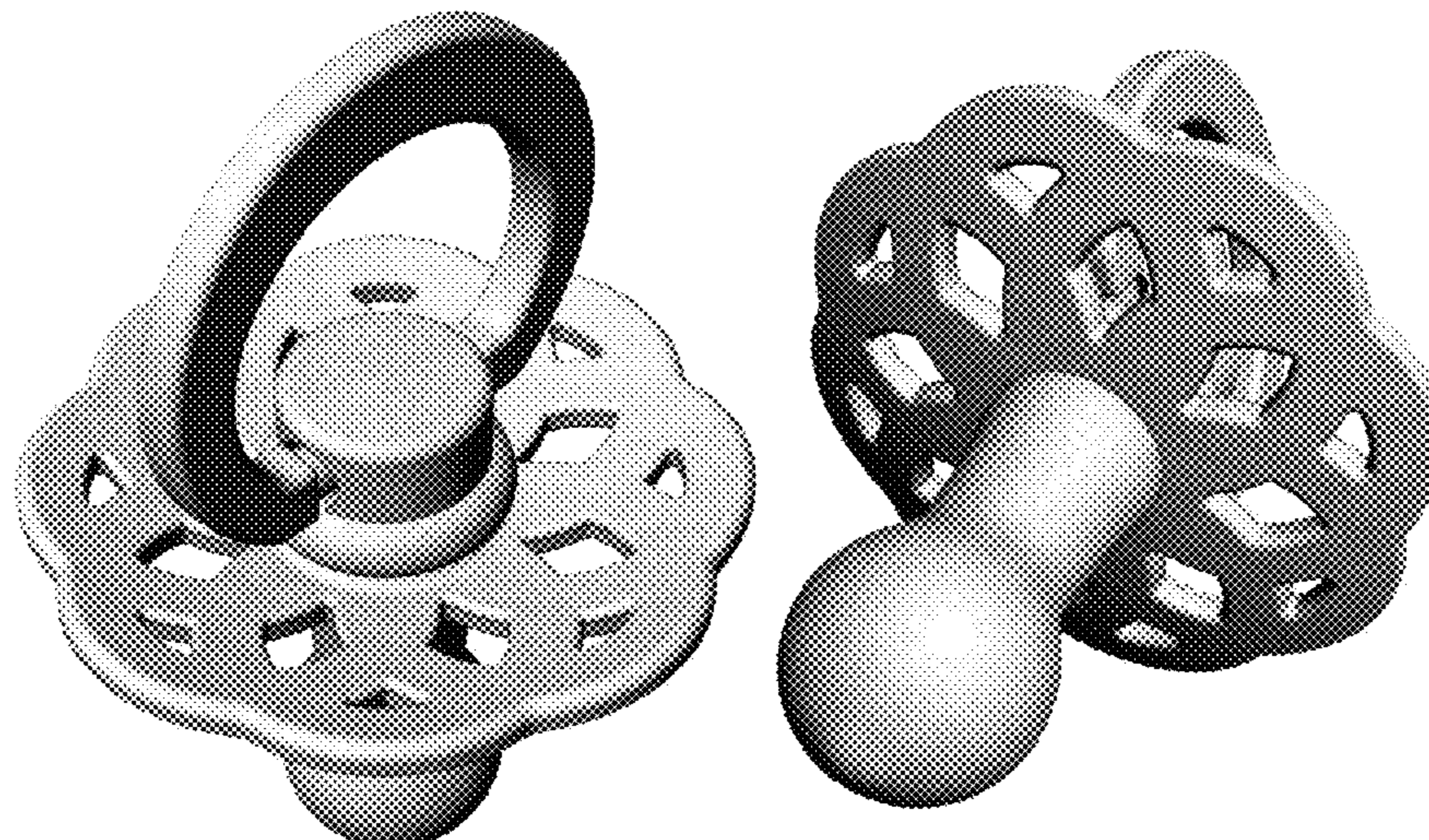

(56)

**References Cited**

U.S. PATENT DOCUMENTS

2009/0248074 A1\* 10/2009 Kliegman ..... A61J 17/001  
606/236

OTHER PUBLICATIONS

“Bumkins: Flower Teether”. Found online Aug. 12, 2022 at amazon.co.jp. Reference dated Oct. 6, 2016. Retrieved from <https://www.amazon.co.jp/-/en/Bumkins-Dental-Genuine-Japanese-Product/dp/B00QC1R1TE/>.\*

“Toyandona: Snowflake Teething Toy”. Found online Aug. 12, 2022 at amazon.co.uk. Reference dated Nov. 4, 2020. Retrieved from <https://www.amazon.co.uk/TOYANDONA-Teethers-Silicone-Snowflake-Teething/dp/B08MPZDMZ9/>.\*

“Lanco: Monstera Leaf Teether”. Found online May 11, 2021 at thedummyshop.com. Reference dated Aug. 24, 2019. Retrieved from [https://tineye.com/search/1521a0c84adce9782566c04c184d479f55f5edc3?sort=crawl\\_date&order=asc&page=1](https://tineye.com/search/1521a0c84adce9782566c04c184d479f55f5edc3?sort=crawl_date&order=asc&page=1).\*

\* cited by examiner

1.1

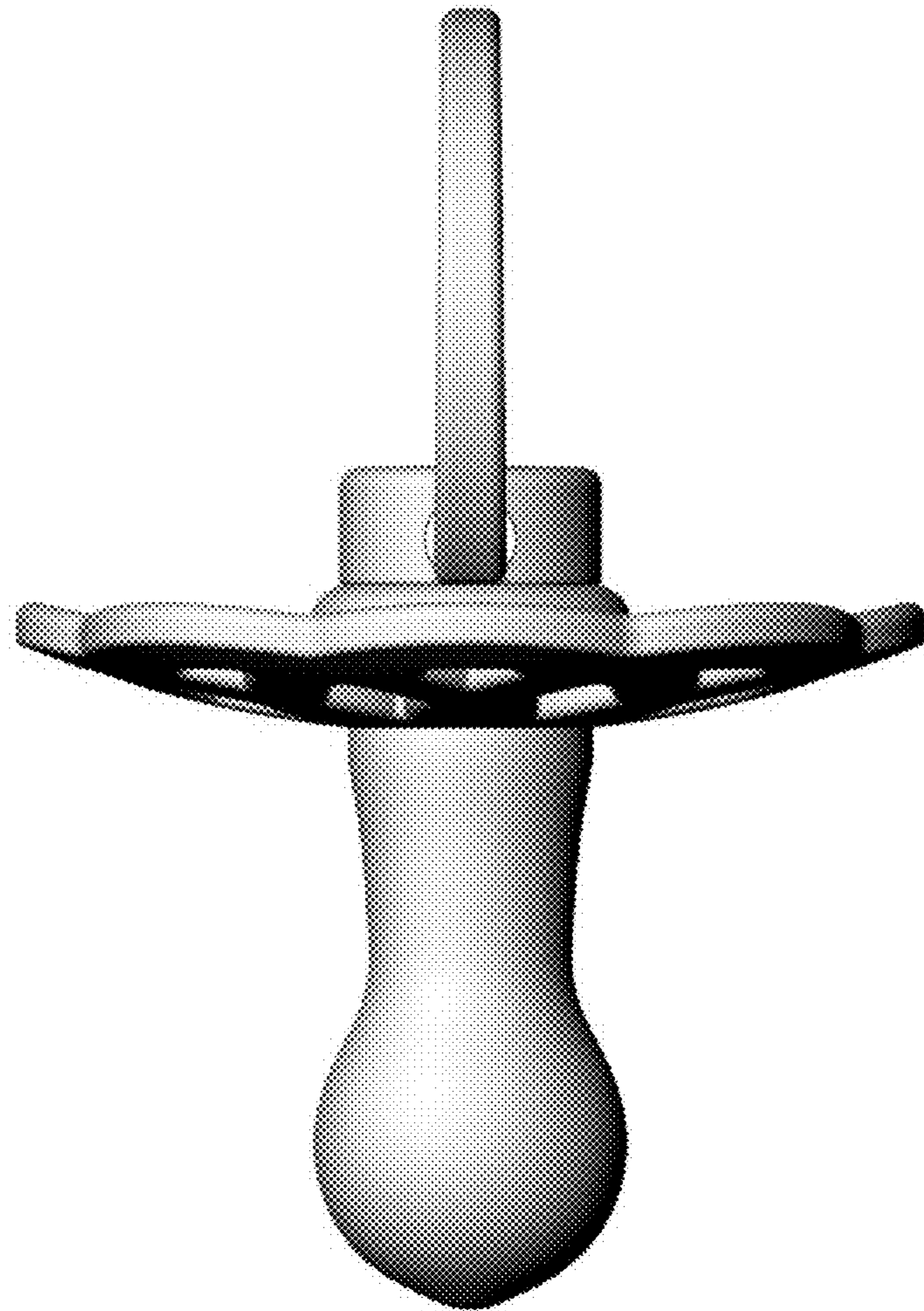



1.2

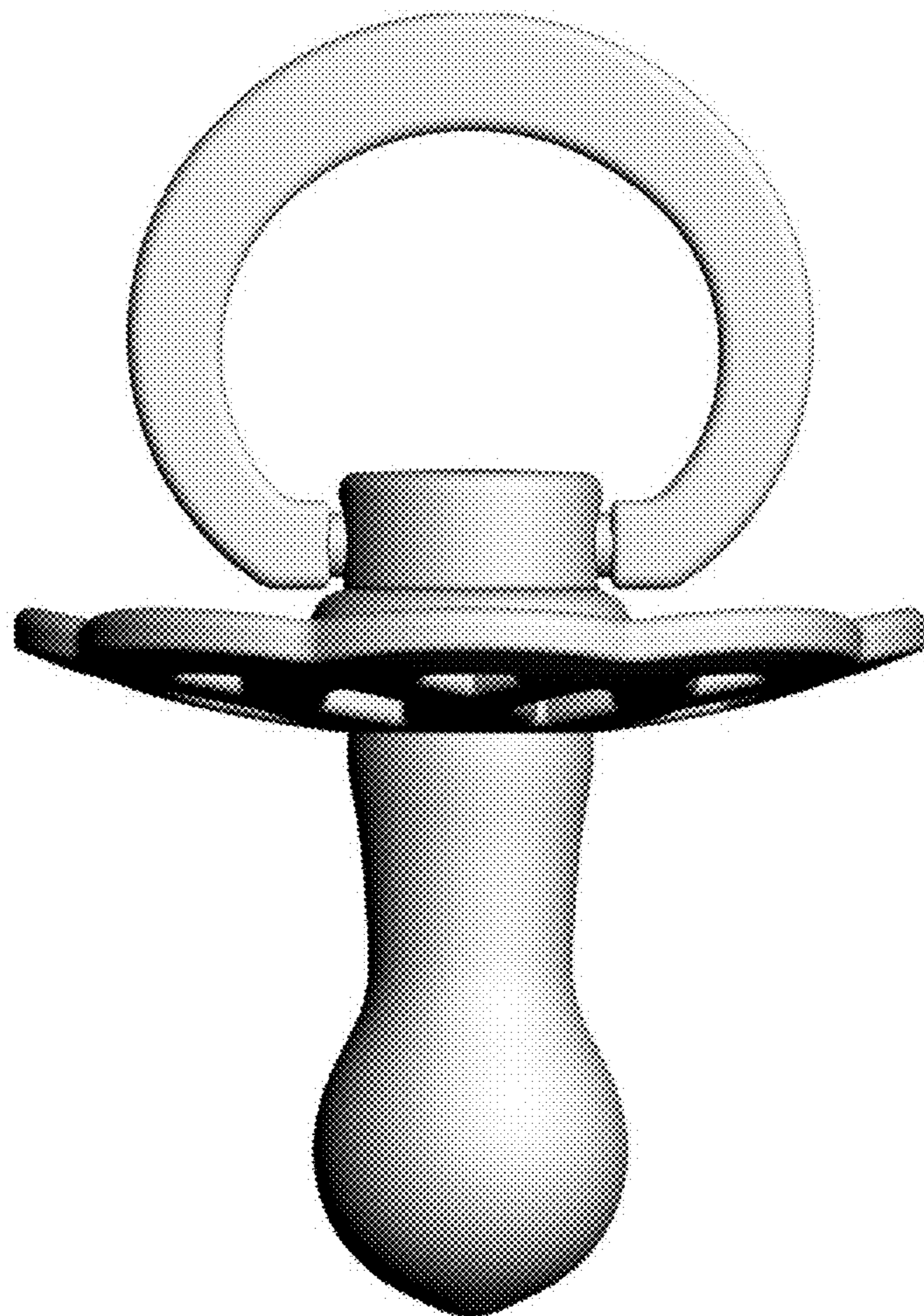

1.3

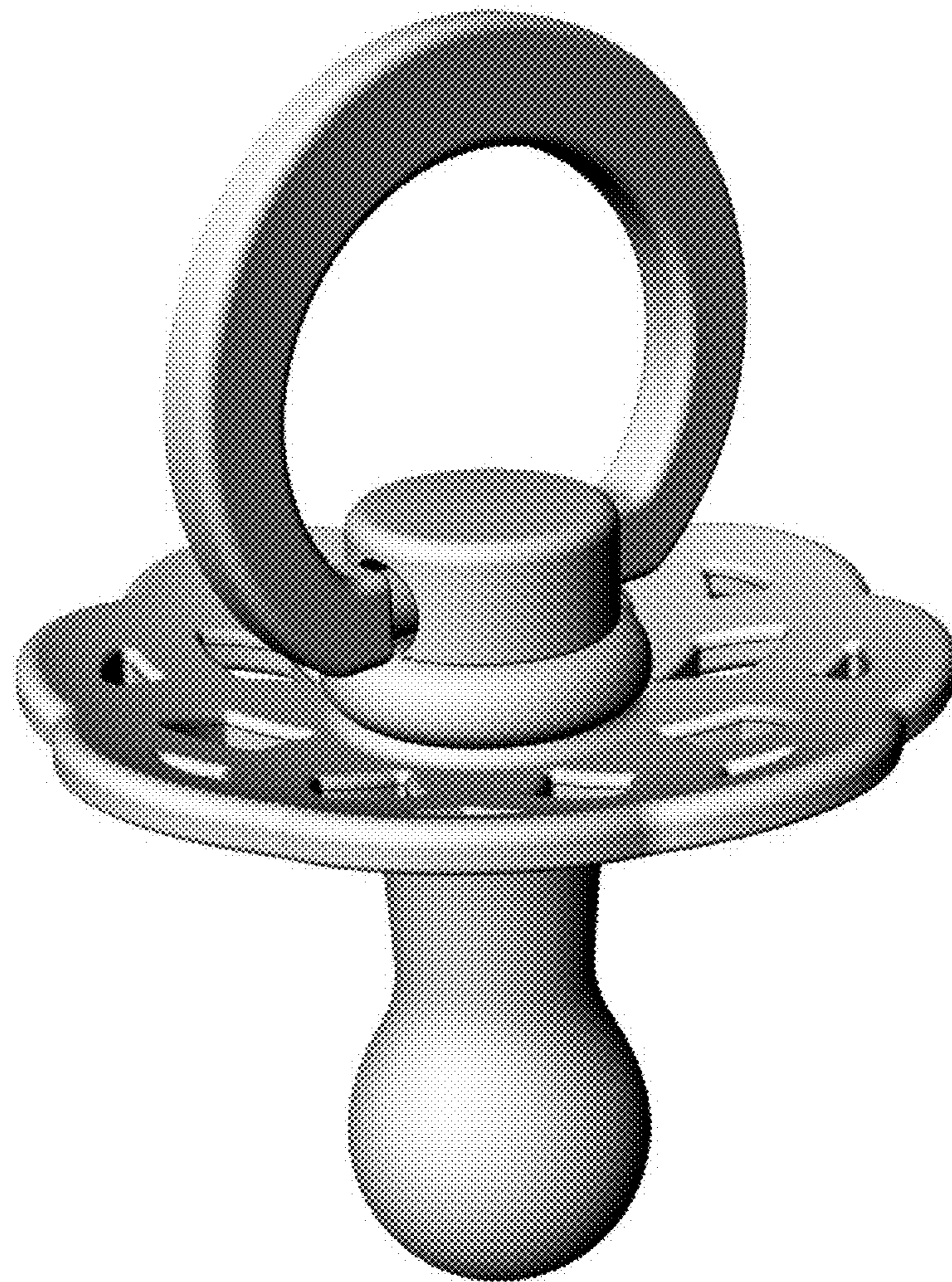



1.4

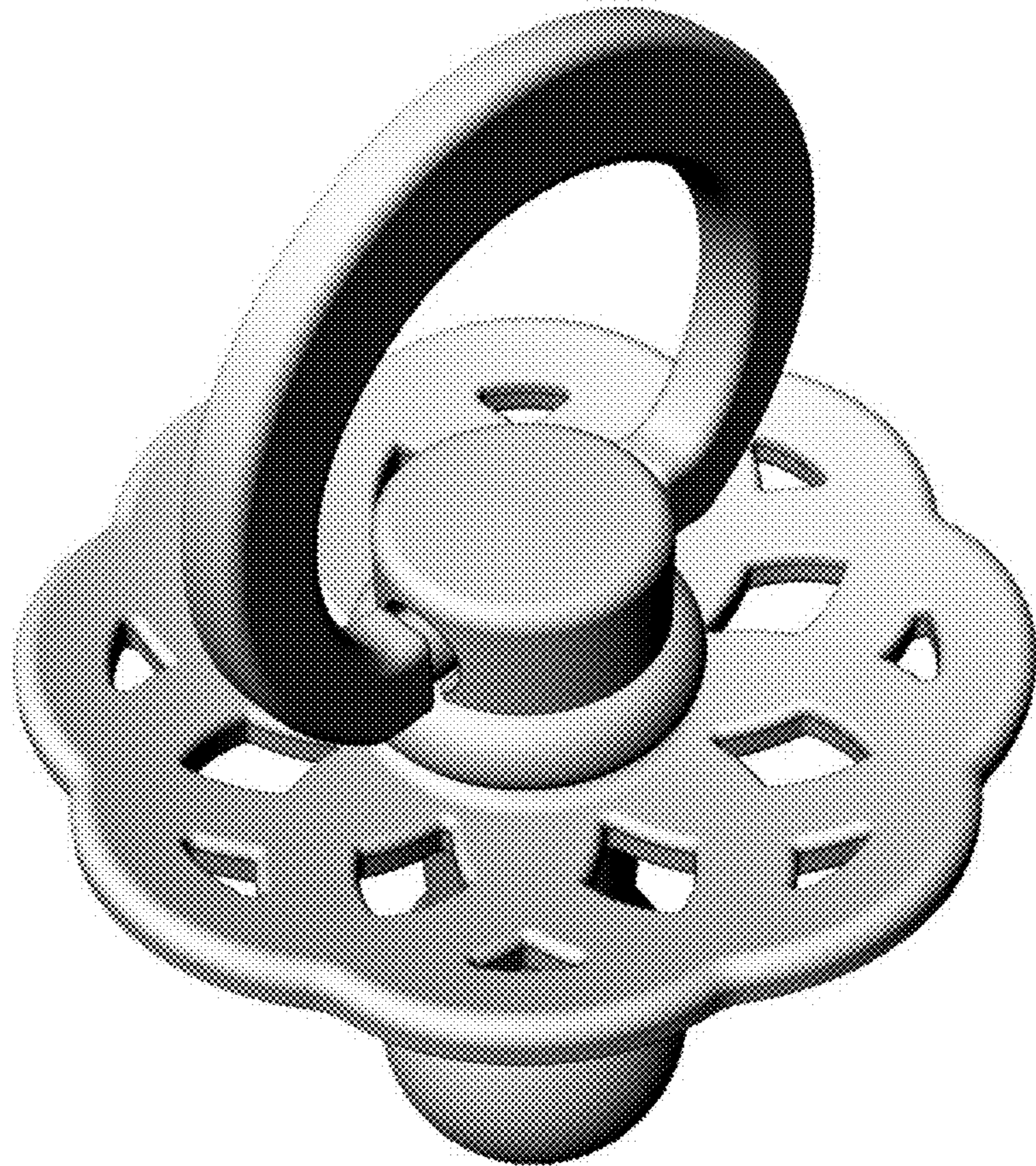

1.5

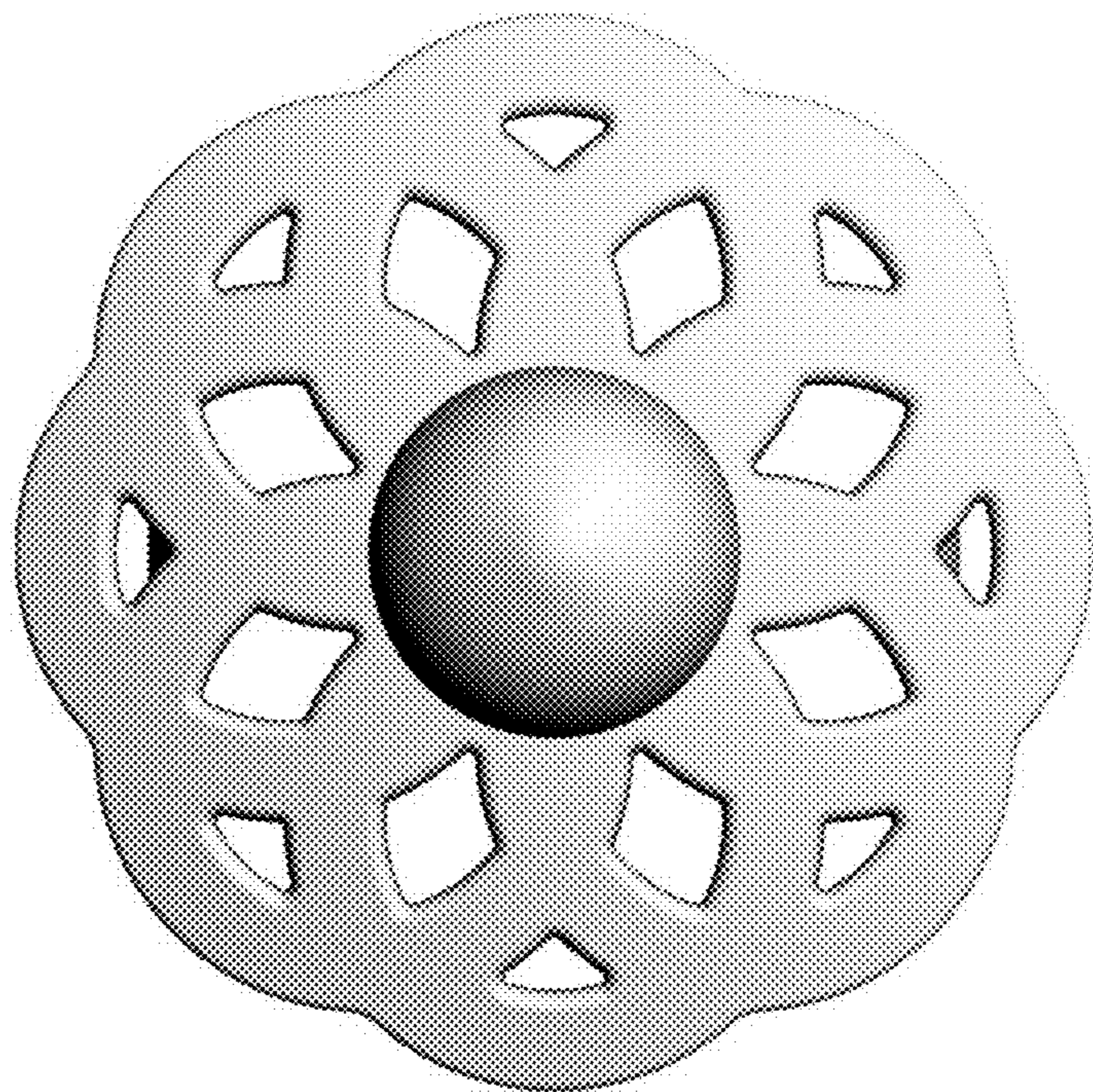



1.6

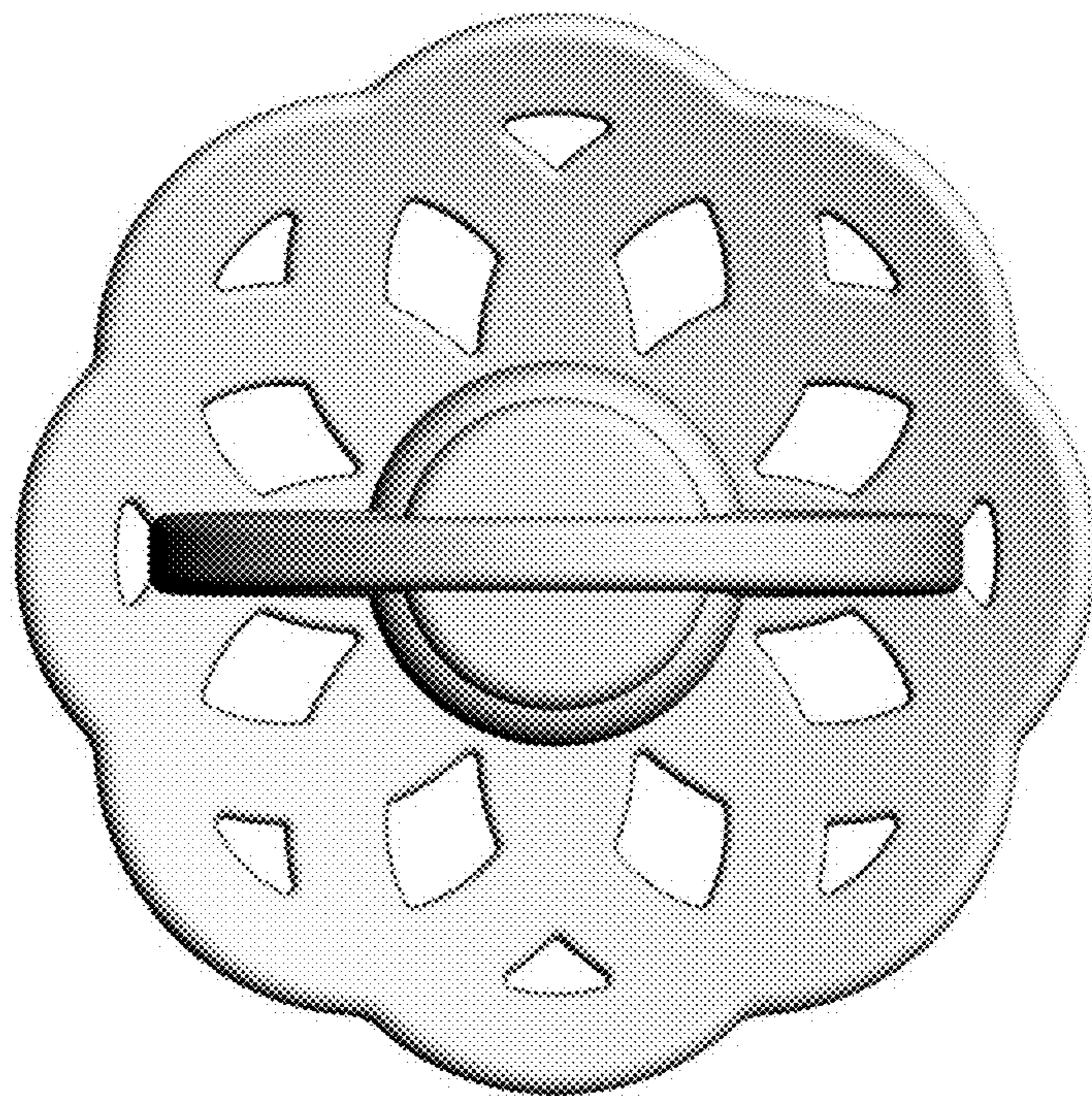



1.7

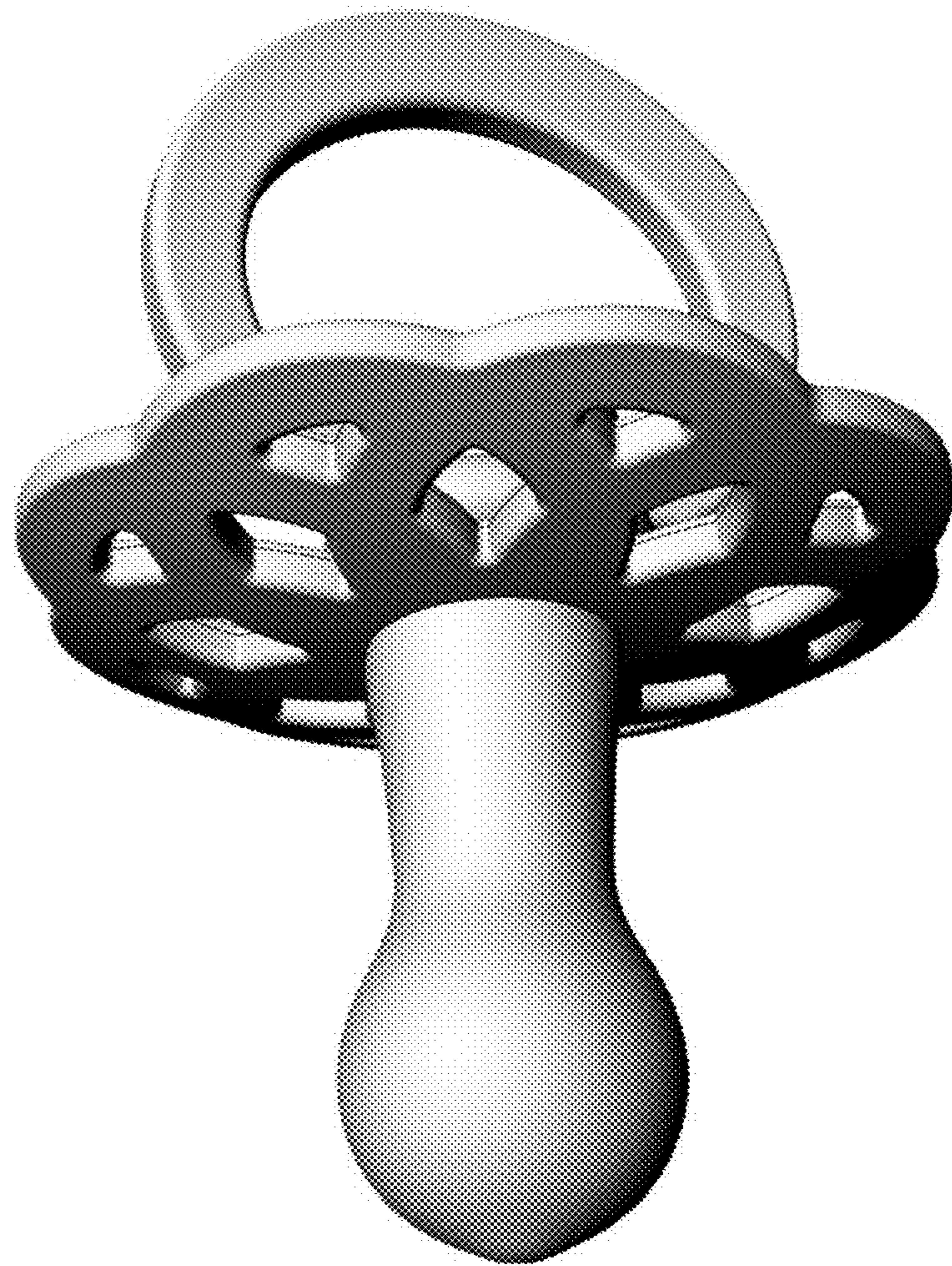

1.8

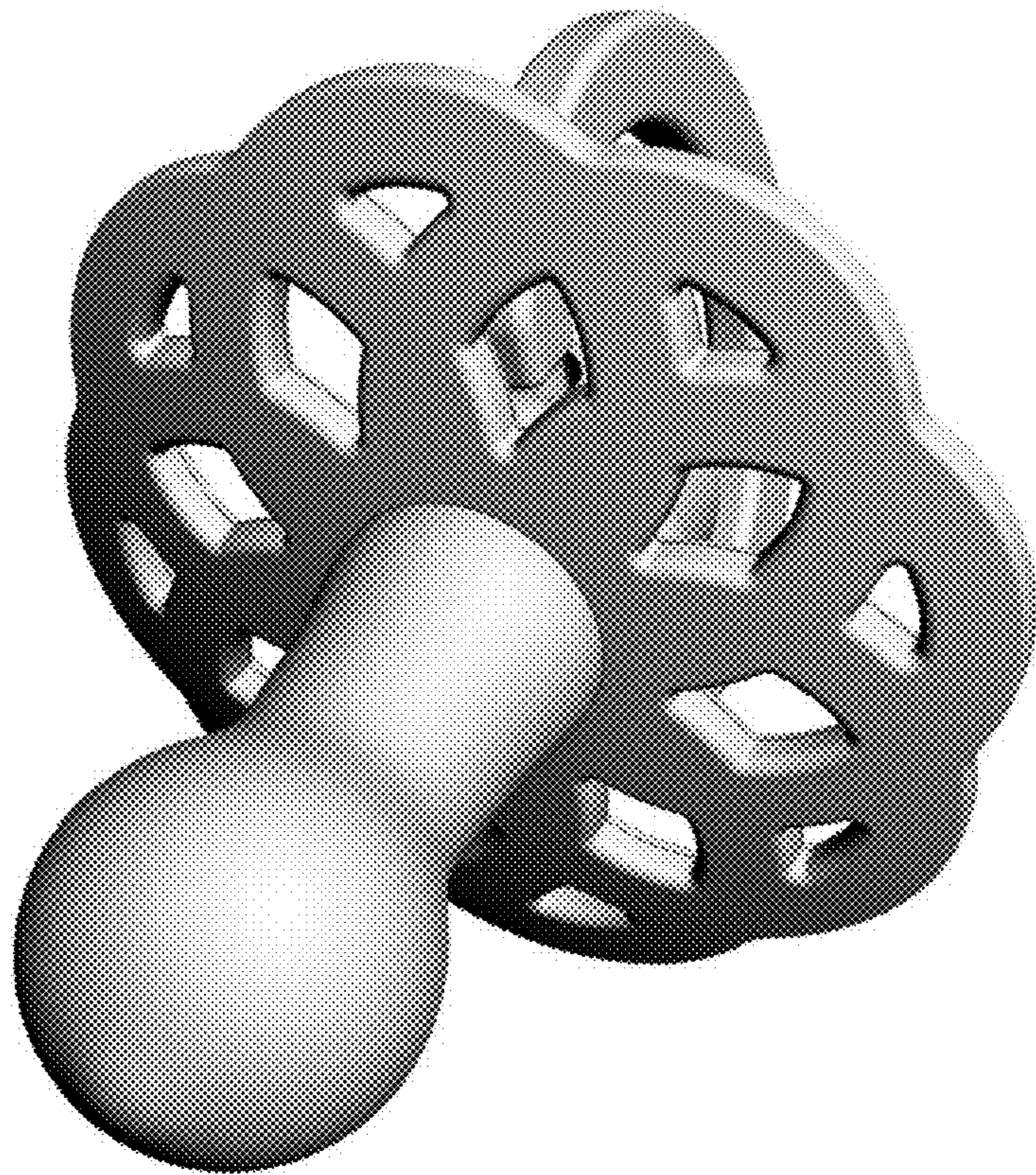



1.9

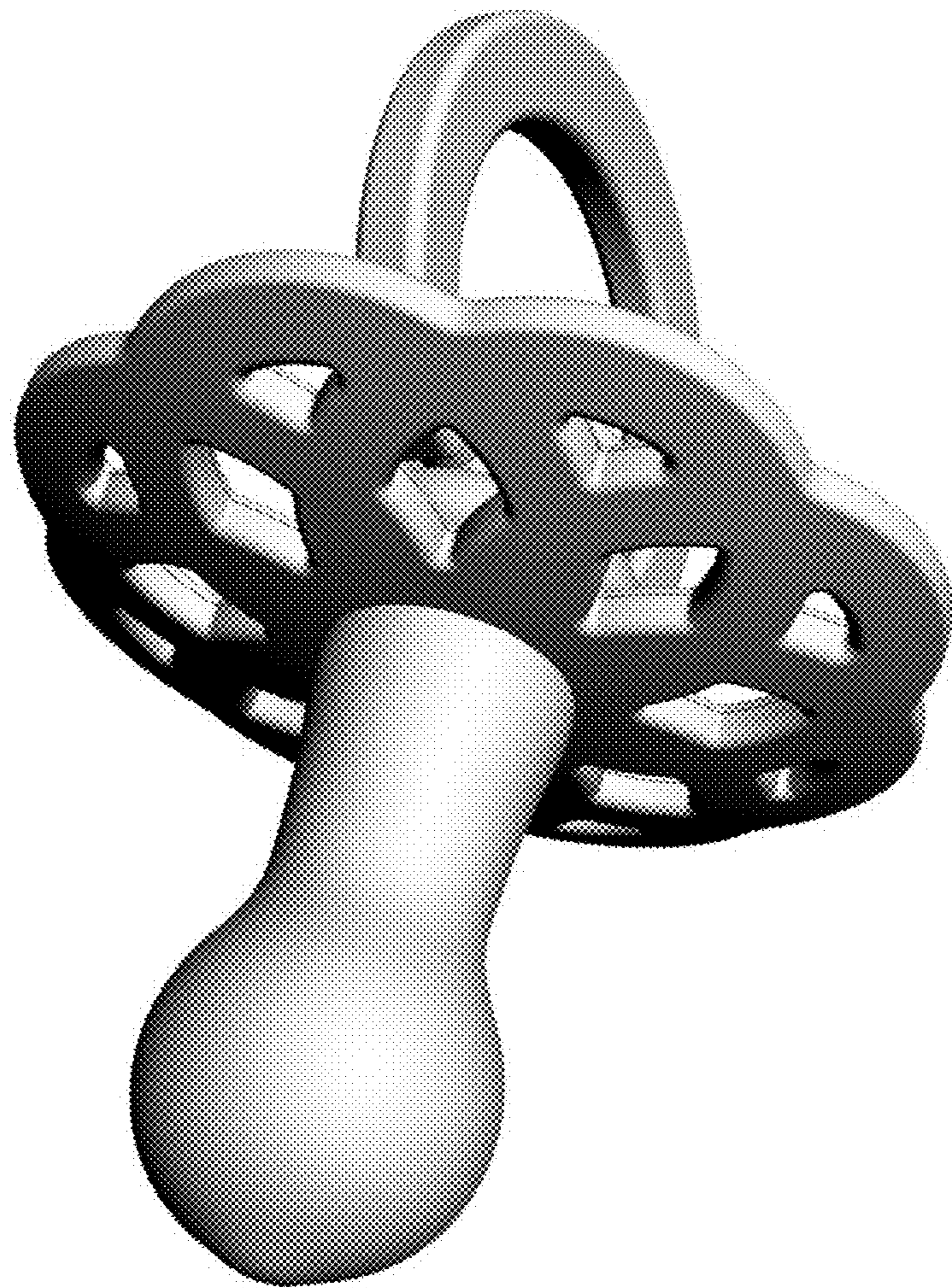

1.10

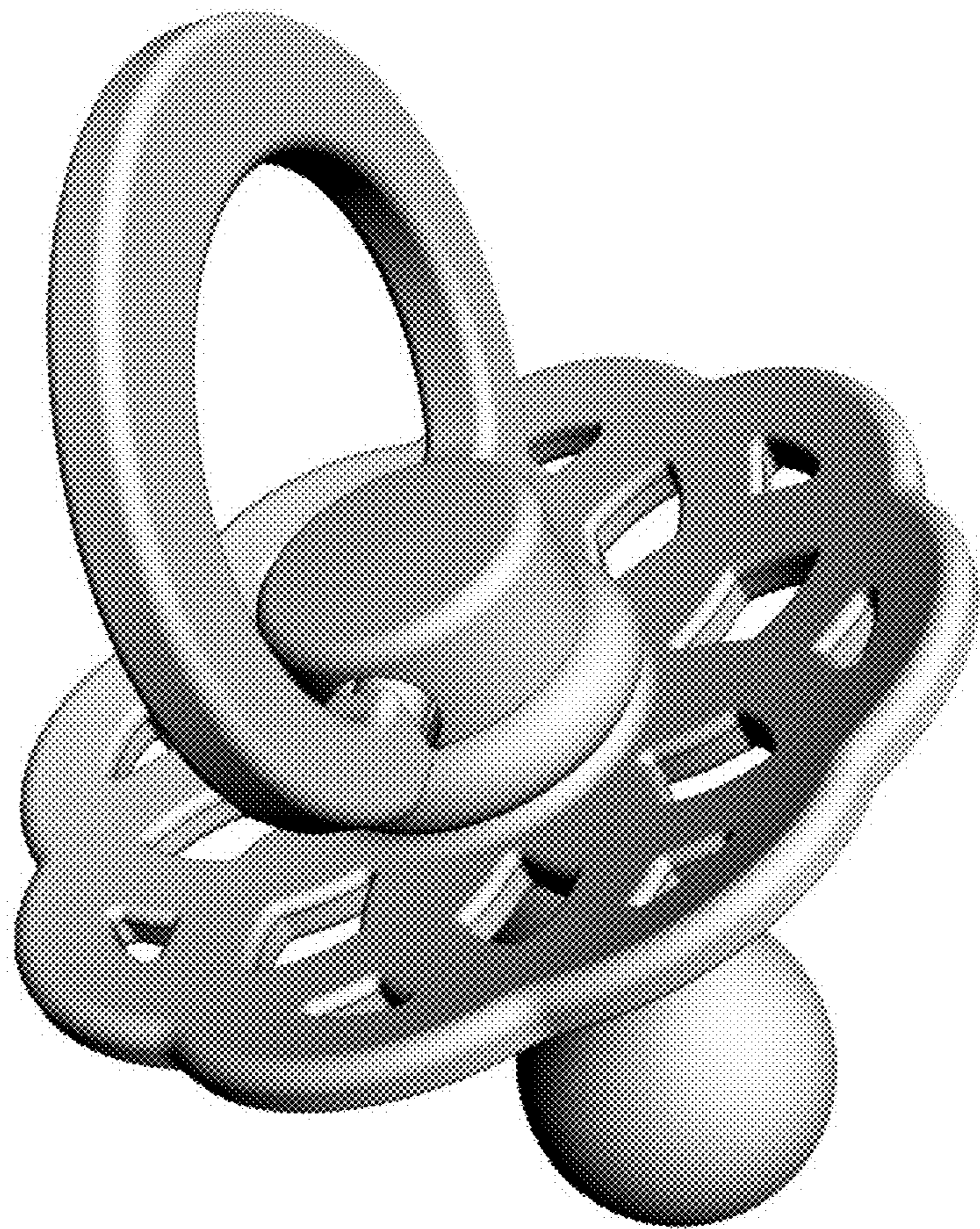



1.11

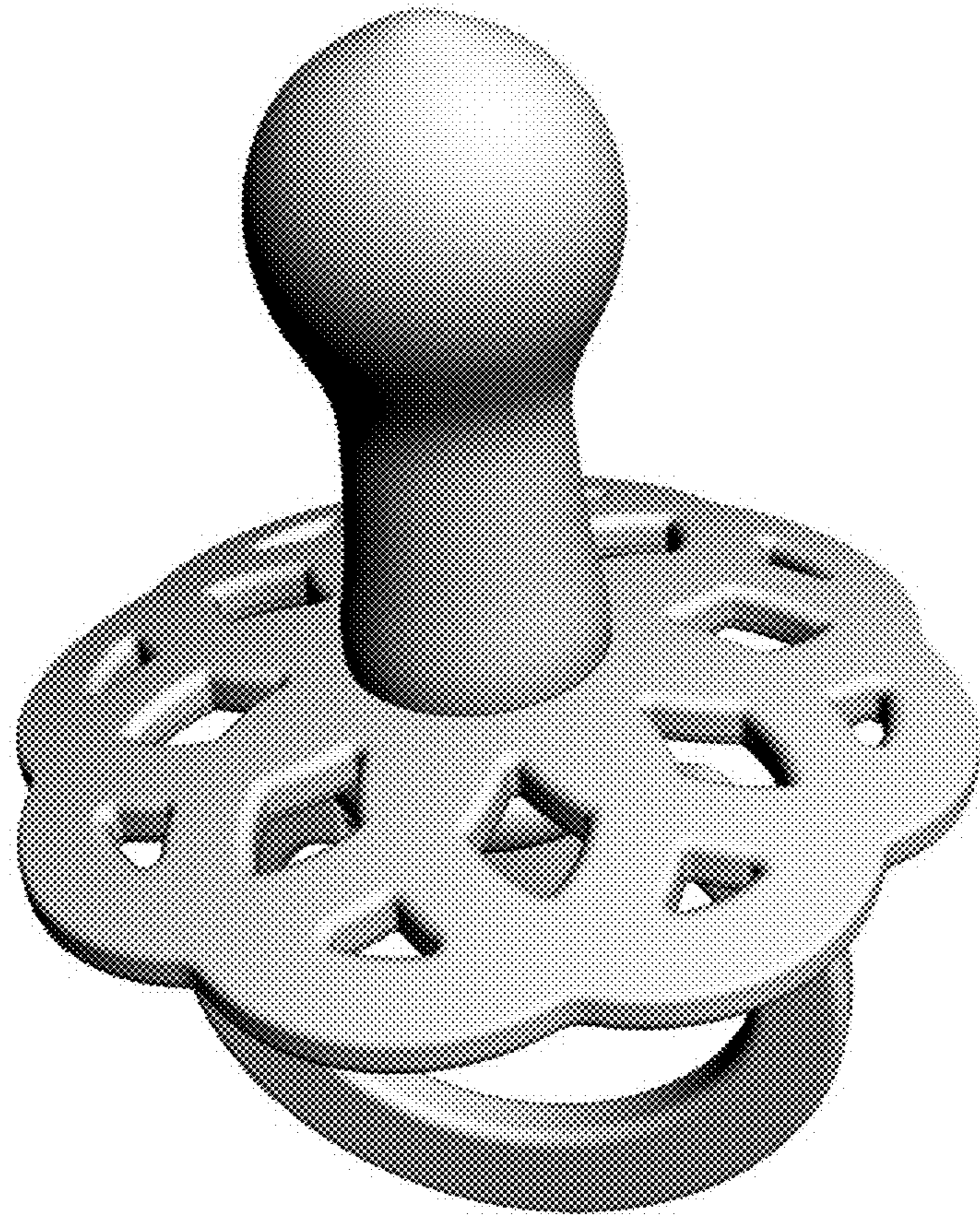

1.12

