



US00D981553S

(12) **United States Design Patent** (10) **Patent No.:** **US D981,553 S**
Bodet et al. (45) **Date of Patent:** **** Mar. 21, 2023**

(54) **NASAL DIFFUSER**
(71) Applicant: **LINDAL FRANCE SAS**, Val-de-Briey (FR)
(72) Inventors: **Hervé Bodet**, Verdun (FR); **Eric Gaillard**, Dieue-sur-Meuse (FR)
(73) Assignee: **LINDAL FRANCE SAS**, Val de Briey (FR)
(**) Term: **15 Years**
(21) Appl. No.: **29/797,794**
(22) Filed: **Jul. 2, 2021**
(30) **Foreign Application Priority Data**

Jun. 10, 2021 (EM) 008571350
(51) **LOC (14) Cl.** **29-02**
(52) **U.S. Cl.**
USPC **D24/110**
(58) **Field of Classification Search**
USPC D24/108, 110, 110.1, 112-115, 127, 128, D24/129, 130, 133, 186; D9/724; 128/200.24, 207.14, 207.15; 600/101, 600/139, 143; 604/93.01, 164.01-164.11, 604/187, 264, 272, 523-528; 606/181, 606/185
CPC A61M 25/0043; A61M 25/0067; A61M 25/0097; A61M 2210/0618; A61M 1/008; A61M 27/00; A61M 39/00; A61F 2/958
See application file for complete search history.

(56) **References Cited**

U.S. PATENT DOCUMENTS

4,946,069 A * 8/1990 Fuchs B05B 11/02 222/320
D331,106 S * 11/1992 Fuchs D24/110
D359,555 S * 6/1995 Funai D24/110
D401,323 S * 11/1998 Ritsche D24/119

D414,261 S * 9/1999 Ritsche D24/110
D414,555 S * 9/1999 Ritsche D24/110
D433,123 S * 10/2000 Sheppard D24/110
6,708,846 B1 * 3/2004 Fuchs A61M 11/007 222/386
D545,959 S * 7/2007 Cierley D24/110
(Continued)

FOREIGN PATENT DOCUMENTS

EM 000664420-0001 A1 3/2007
EM 000664420-0002 A1 3/2007
(Continued)

OTHER PUBLICATIONS

Nasal diffuser, "Prorhinel", GSK (date unspecified).
(Continued)

Primary Examiner — Richard Kearney
Assistant Examiner — Michael Hoffman
(74) *Attorney, Agent, or Firm* — Seckel IP, PLLC

(57) **CLAIM**

The ornamental design for a nasal diffuser, as shown and described.

DESCRIPTION

FIG. 1 is a rear right side perspective view of a nasal diffuser;
FIG. 2 is a right side view thereof;
FIG. 3 is a rear view thereof;
FIG. 4 is a front view thereof;
FIG. 5 is a left side perspective view thereof;
FIG. 6 is front left side perspective view thereof; and,
FIG. 7 is a top view thereof.
The dot-dash-dot broken lines illustrate the bounds of the claim and the dash-dash broken lines illustrate environmental subject matter; all broken lines form no part of the claimed design.

1 Claim, 7 Drawing Sheets

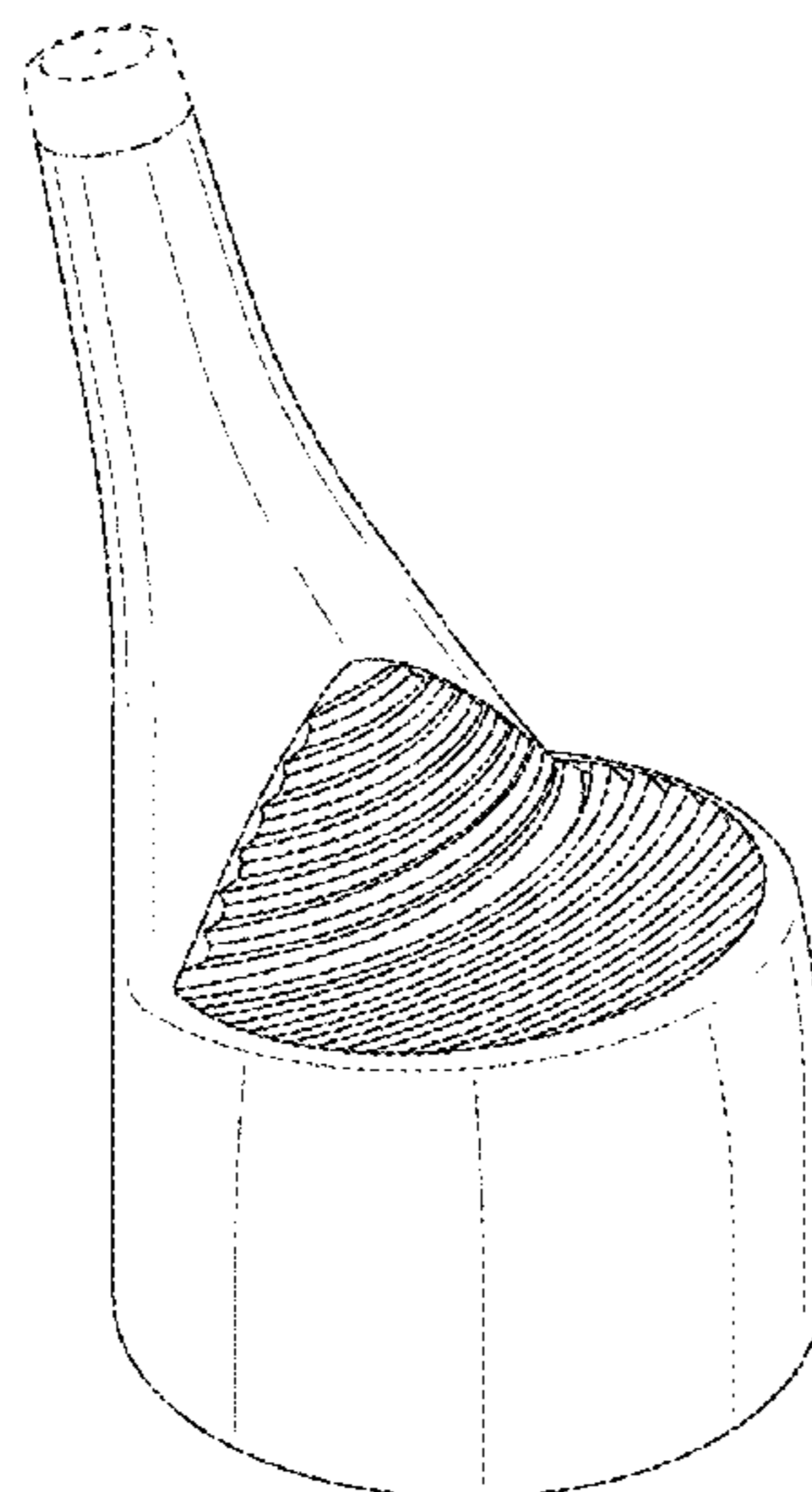

(56)

References Cited

U.S. PATENT DOCUMENTS

D684,255 S * 6/2013 Ritsche D24/110
D694,399 S * 11/2013 Ritsche D24/110
D697,201 S * 1/2014 Coghill D24/110
D828,543 S * 9/2018 Khan D24/114

FOREIGN PATENT DOCUMENTS

EM 002470153-0001 A1 7/2014
EM 005820693-0001 A1 11/2018
EM 005820693-0002 A1 11/2018

OTHER PUBLICATIONS

Nasal diffuser, "Sinomarin", Omega Pharma (date unspecified).
Nasal diffuser, "Physiomer", Laboratoire de la mer (date unspecified).
Nasal diffuser, "Marimer", Laboratoire Gilbert (date unspecified).
Nasal diffuser, "Physiologica", Gifrer (date unspecified).

* cited by examiner

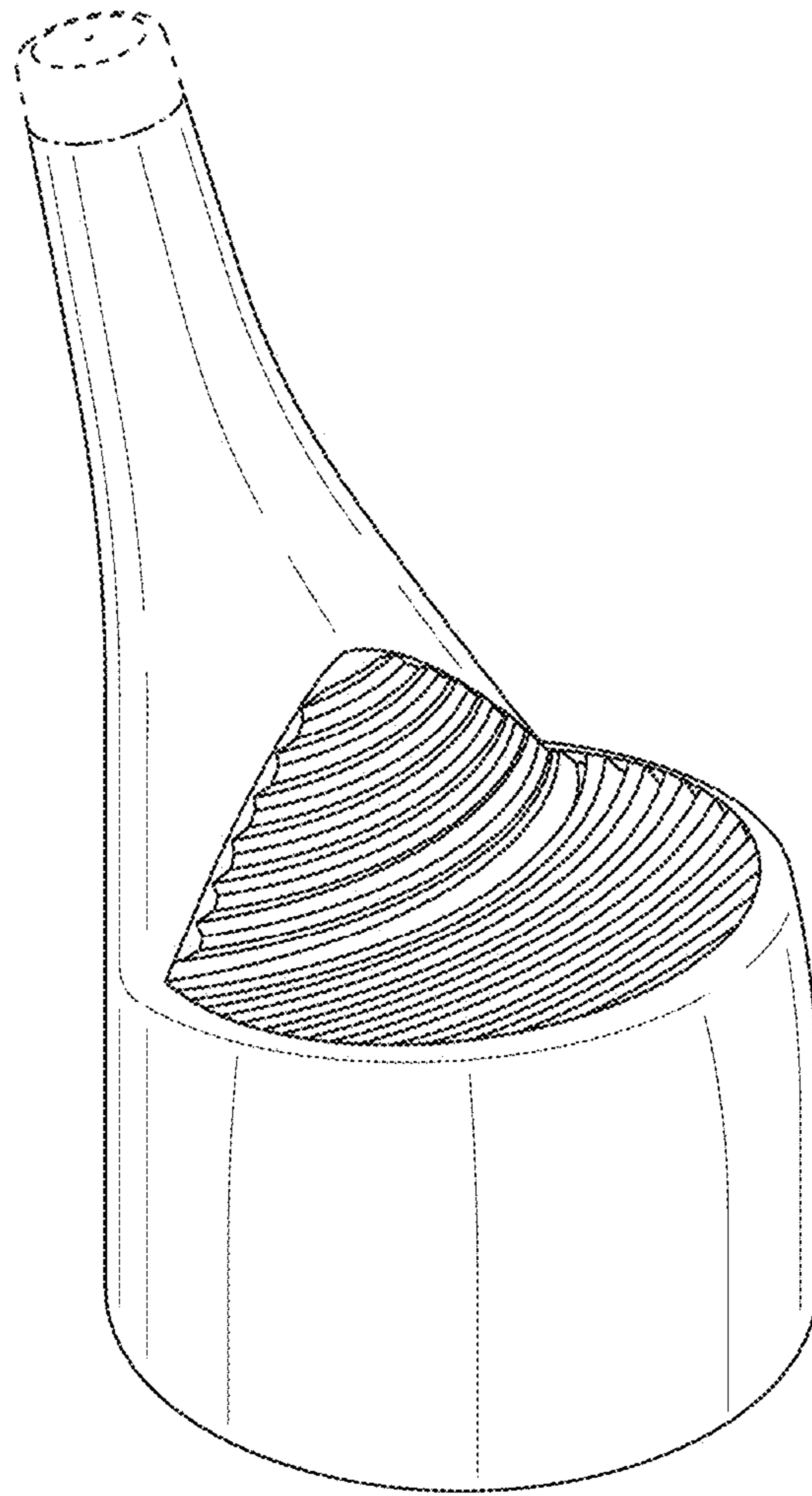

FIG. 1

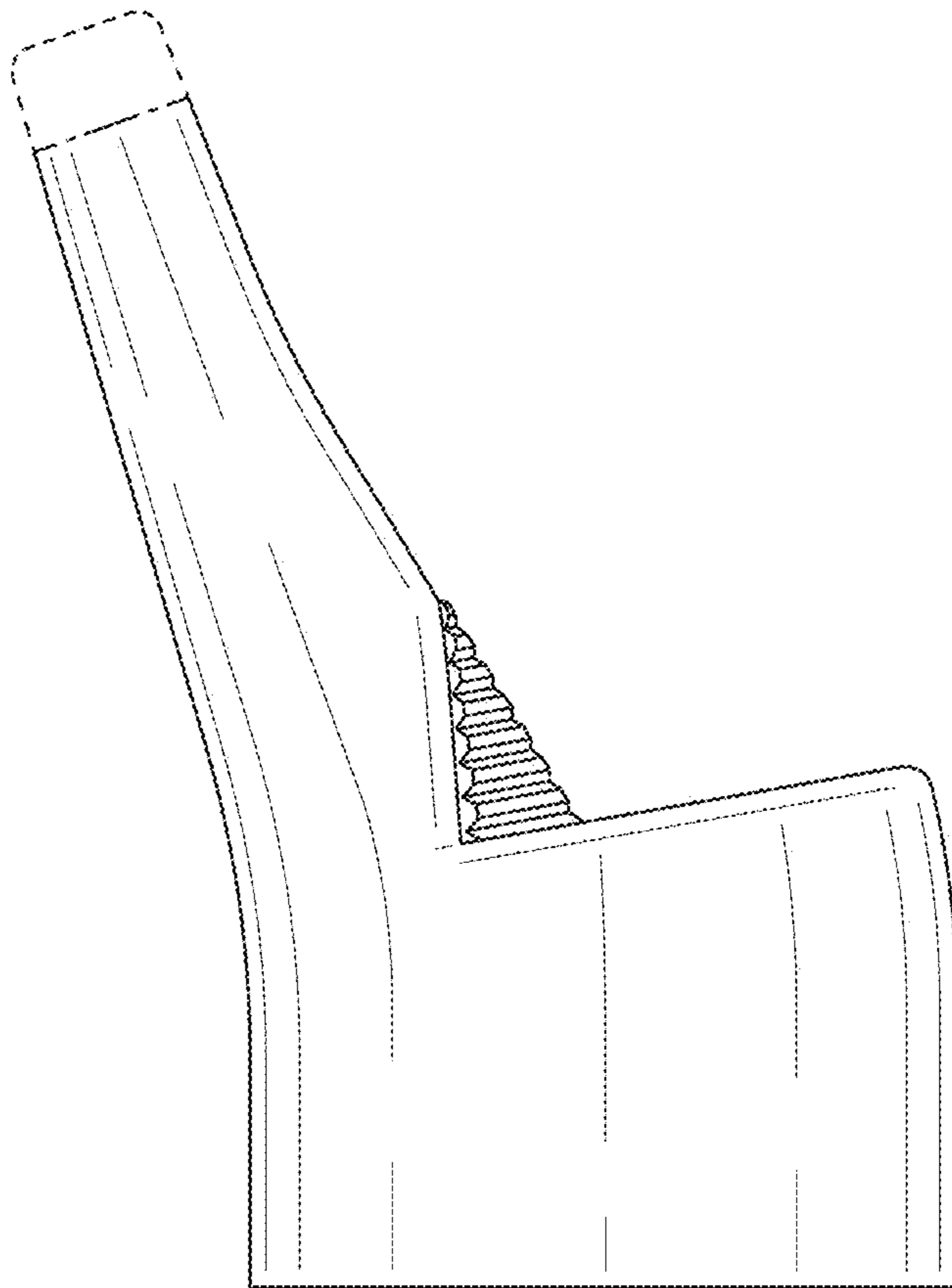

FIG. 2

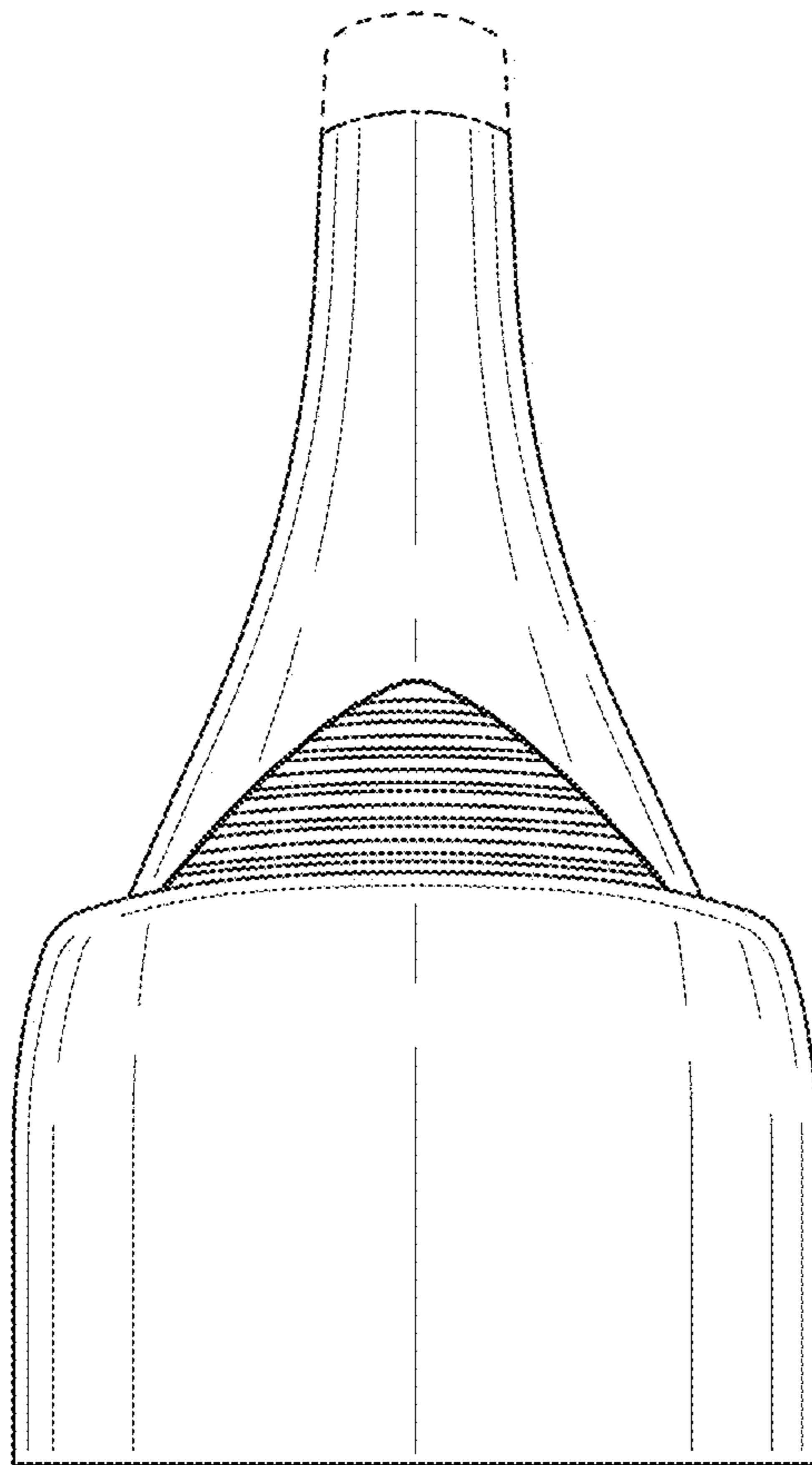

FIG. 3

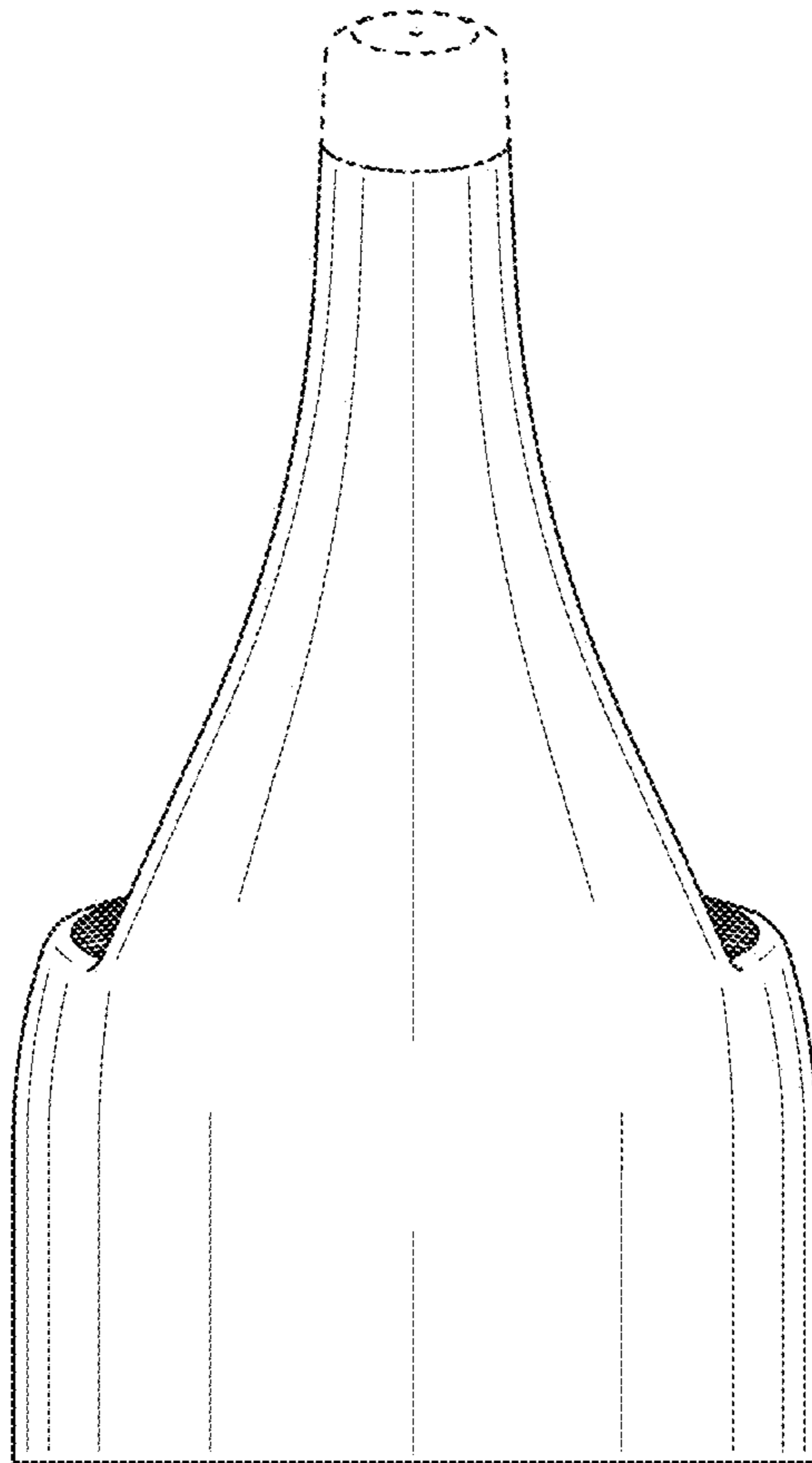

FIG. 4

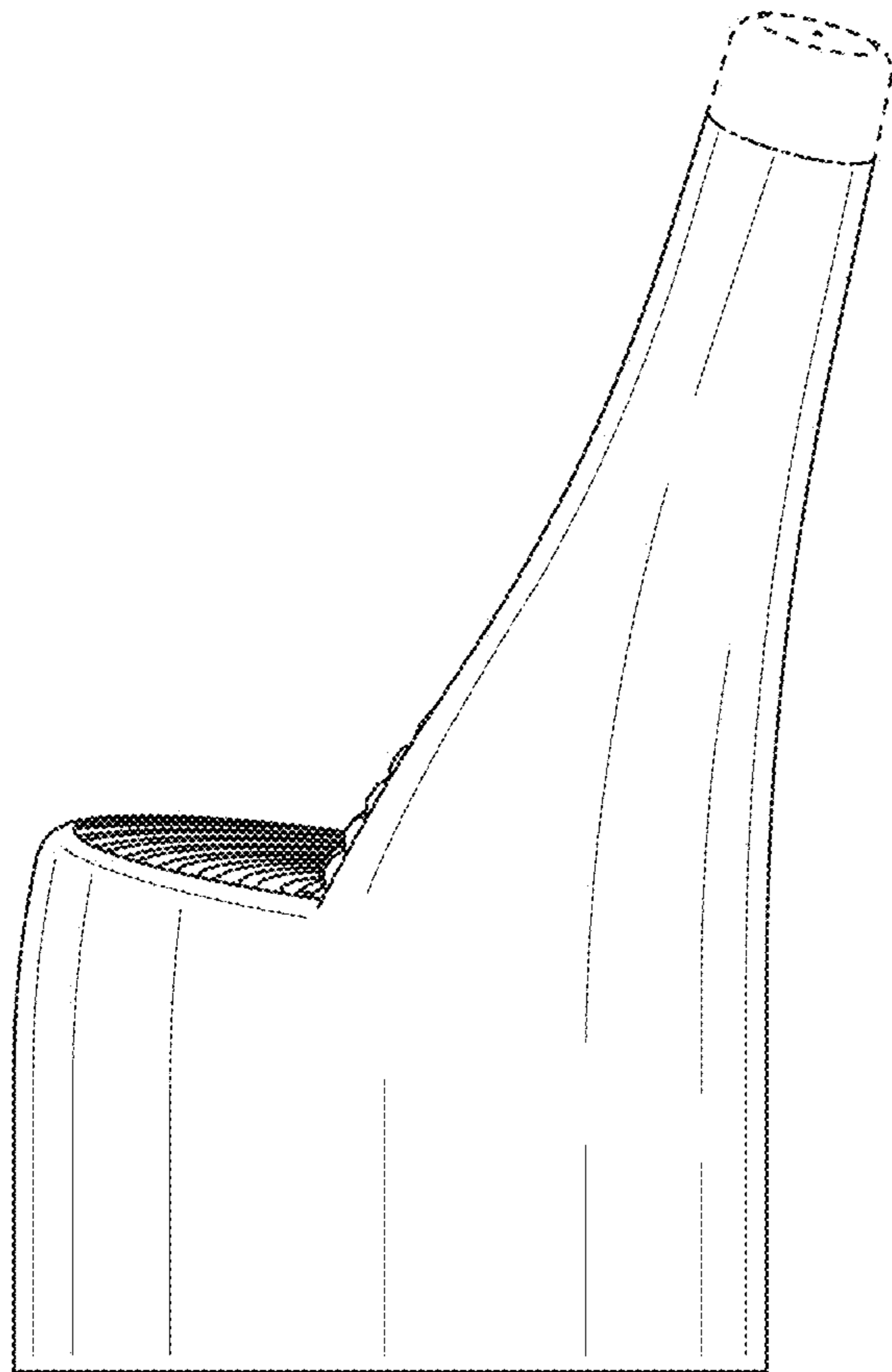

FIG. 5

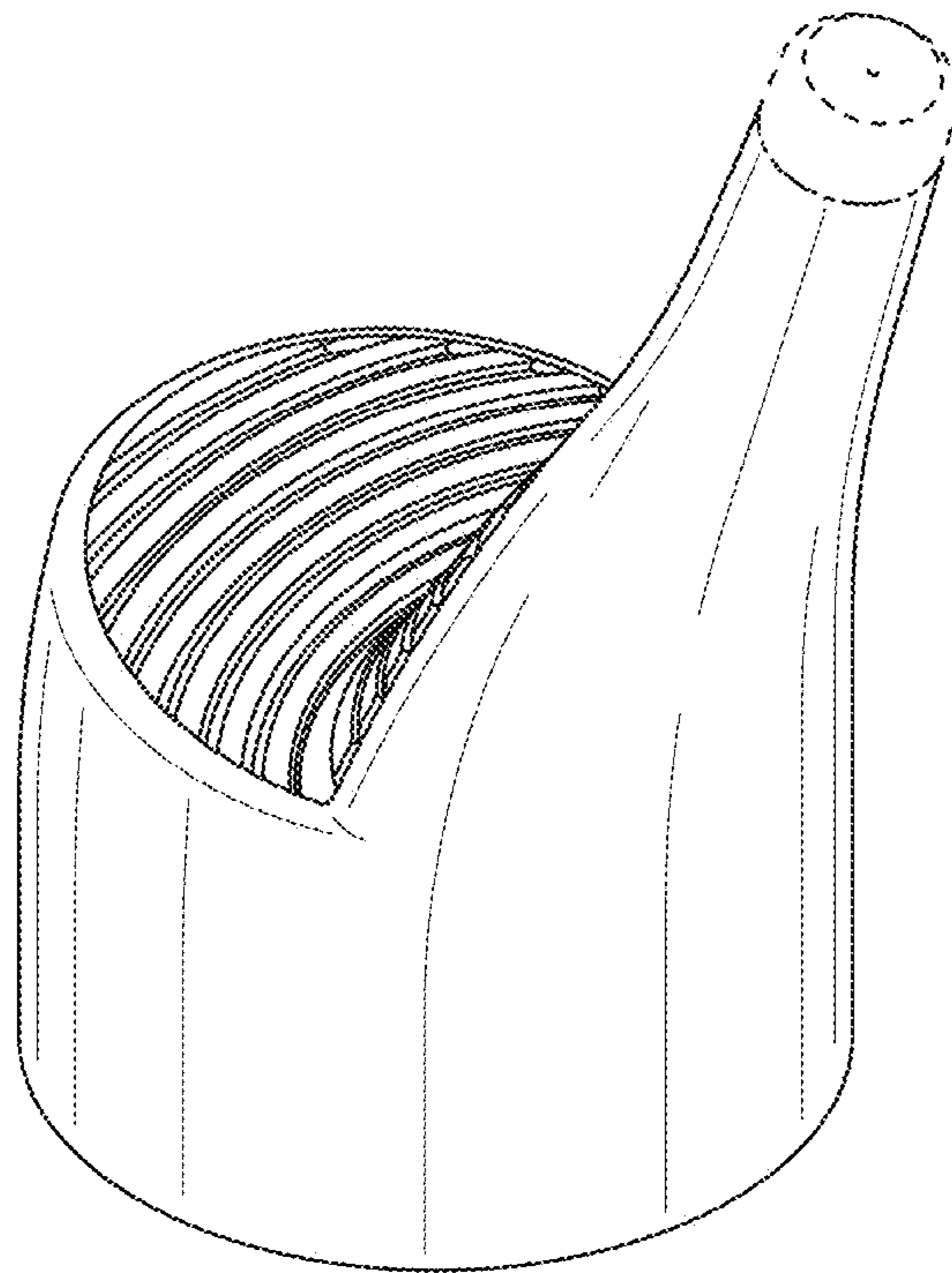

FIG. 6

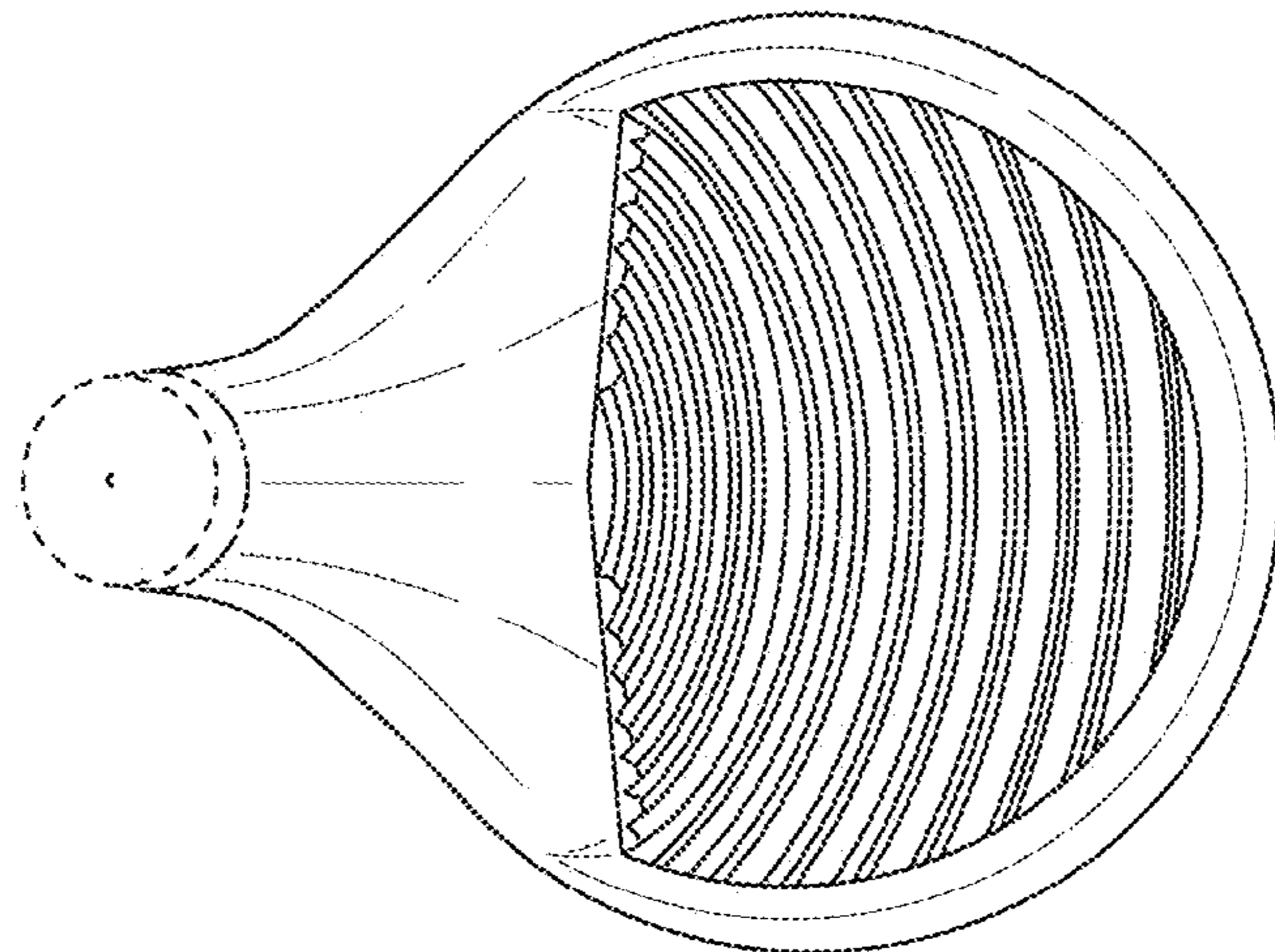

FIG. 7