



US00D981544S

(12) **United States Design Patent**
Kim et al.

(10) **Patent No.:** **US D981,544 S**
(45) **Date of Patent:** **** Mar. 21, 2023**

(54) **AIR PURIFIER FOR AUTOMOBILE**

FOREIGN PATENT DOCUMENTS

(71) Applicant: **LG ELECTRONICS INC.**, Seoul
(KR)

KR 300947643 * 3/2018
KR 301017558 * 8/2019

(72) Inventors: **Dongeun Kim**, Seoul (KR); **Seungil Lee**, Seoul (KR); **Hophil Lee**, Seoul (KR)

OTHER PUBLICATIONS

(73) Assignee: **LG ELECTRONICS INC.**, Seoul
(KR)

FrescheAir Pro Portable HEPA Air Purifier/Deodorizer, available in scosche.com, announced Year 2021 [online], [site visited Aug. 4, 2022], Internet URL: <https://www.scosche.com/portable-hepa-air-purifier-deodorizer> (Year: 2021).*

(Continued)

(**) Term: **15 Years**

Primary Examiner — Amy C Wierenga

(21) Appl. No.: **29/768,811**

Assistant Examiner — Kathryn Elizabeth Zieno

(22) Filed: **Feb. 1, 2021**

(74) *Attorney, Agent, or Firm* — Birch, Stewart, Kolasch & Birch, LLP

(30) **Foreign Application Priority Data**

Aug. 7, 2020 (KR) 30-2020-0036955

(57) **CLAIM**

(51) **LOC (14) Cl.** **23-04**

We claim the ornamental design for an air purifier for automobile, as shown and described.

(52) **U.S. Cl.**
USPC **D23/364**; D23/365

(58) **Field of Classification Search**
USPC D23/366, 333, 370, 381, 332, 334
CPC B01D 46/00; F24F 13/10
See application file for complete search history.

DESCRIPTION

(56) **References Cited**

FIG. 1 is a perspective view of an air purifier for automobile showing the new design;
FIG. 2 is a front elevation view thereof;
FIG. 3 is a rear elevation view thereof;
FIG. 4 is a left-side elevation view thereof;
FIG. 5 is a right-side elevation view thereof;
FIG. 6 is a top plan view thereof;
FIG. 7 is a bottom plan view thereof; and,
FIG. 8 is a perspective view showing a state of use thereof. The broken lines represent portions of the air purifier for automobile that form no part of the claimed design. The broken lines on the upper display part in FIG. 8 are for environment purpose only and form no part of the claimed design.

U.S. PATENT DOCUMENTS

D803,369 S	*	11/2017	Kim	D23/364
D806,844 S	*	1/2018	Kim	D23/364
D806,845 S	*	1/2018	Kim	D23/364
D807,998 S	*	1/2018	Kim	D23/364
D818,095 S	*	5/2018	Cho	D23/364
D818,096 S	*	5/2018	Cho	D23/364
D818,099 S	*	5/2018	Cho	D23/364
D820,422 S	*	6/2018	Kim	D23/364
D829,312 S	*	9/2018	Riering-Czekalla	D23/364
D829,313 S	*	9/2018	Cho	D23/364
D829,314 S	*	9/2018	Cho	D23/364
D831,810 S	*	10/2018	Cho	D23/364
D831,811 S	*	10/2018	Cho	D23/364

(Continued)

1 Claim, 8 Drawing Sheets

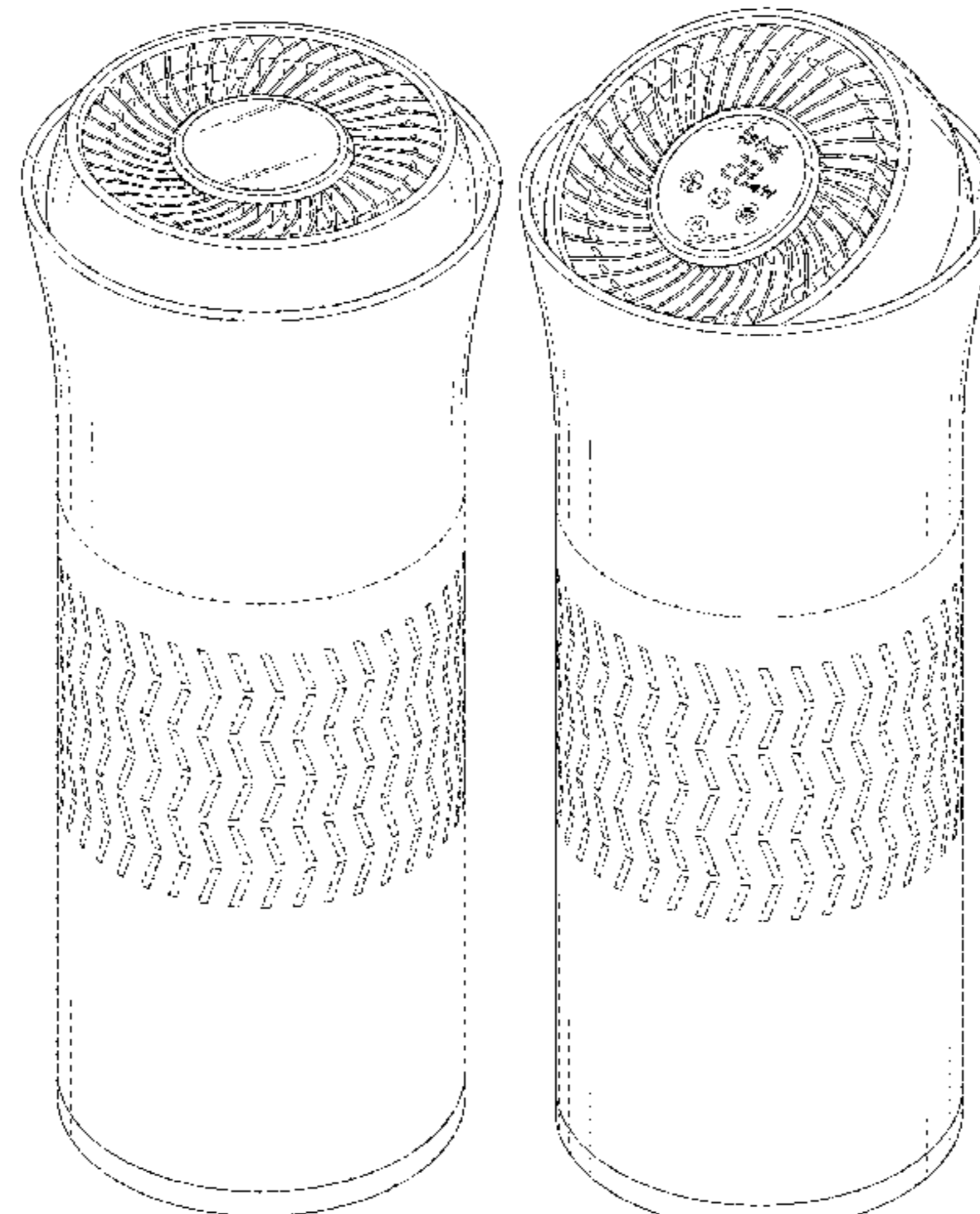

(56)

References Cited

U.S. PATENT DOCUMENTS

D835,766	S	*	12/2018	Chen	D23/364
10,151,499	B2	*	12/2018	Lee	B01D 46/10
D838,355	S	*	1/2019	Cho	D23/365
D840,009	S	*	2/2019	Suarez	D23/328
D855,785	S	*	8/2019	Kim	D23/364
D855,787	S	*	8/2019	Sakamoto	D23/370
D877,874	S	*	3/2020	Liu	D23/364
D886,975	S	*	6/2020	Yang	D23/364
D888,919	S	*	6/2020	Riering-Czekalla	D23/364
D933,189	S	*	10/2021	Kim	D23/378
2019/0184324	A1	*	6/2019	Lee	B01D 46/44

OTHER PUBLICATIONS

Three Musketeers III M Mini Portable Air Purifier, available in Amazon.com, customer review oldest date Feb. 29, 2019 [online],

[site visited Aug. 4, 2022], Available from the internet URL: <https://www.amazon.com/THREE-MUSKETEERS-III-Portable-Conservation/dp/B07RFFMDHR> (Year: 2019).*

Sea Metal Car Air Purifier, available in aliexpress.com, announced Year 2022 [online], [site visited Aug. 4, 2022], Internet URL: <https://www.aliexpress.com/item/2255800577881871.html?gatewayAdapt> (Year: 2022).*

Devitop Car Air Purifier 4-om 1 Composite Filter Hepa 13 Low Energy Consumption Plasma Purifying, available in globalsources.com, announced Year 2021 [online], [site visited Aug. 4, 2022], Internet URL: <https://www.globalsources.com/Car-ionizer/car-air-purifier-1182680745p.htm> (Year: 2021).*

Devitop New Car Ionizer Portable Air Cleaner for Desktop Table Car Air Purifier, available in globalsources.com, announced Year 2021 [online], [site visited Aug. 4, 2022], Internet URL: <https://www.globalsources.com/Car-ionizer/car-air-purifier-1183360026p.htm> (Year: 2021).*

* cited by examiner

FIG. 1

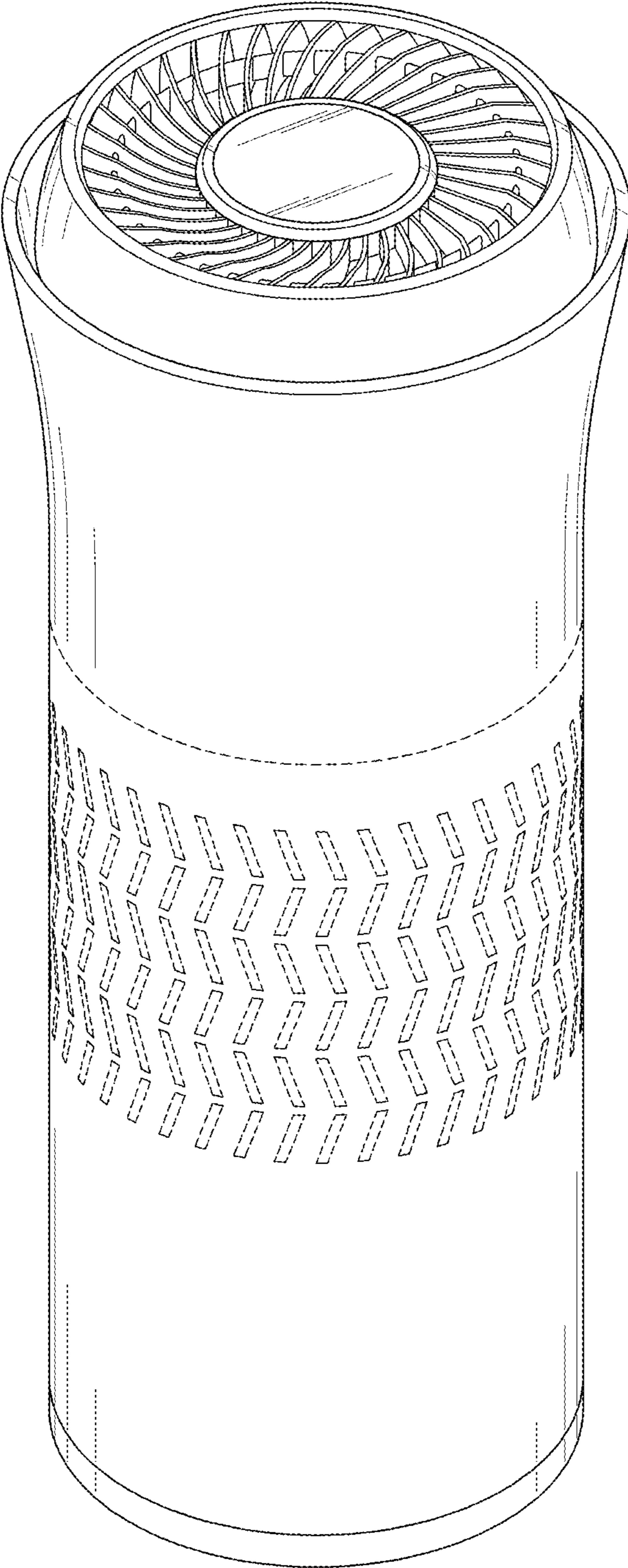

FIG. 2

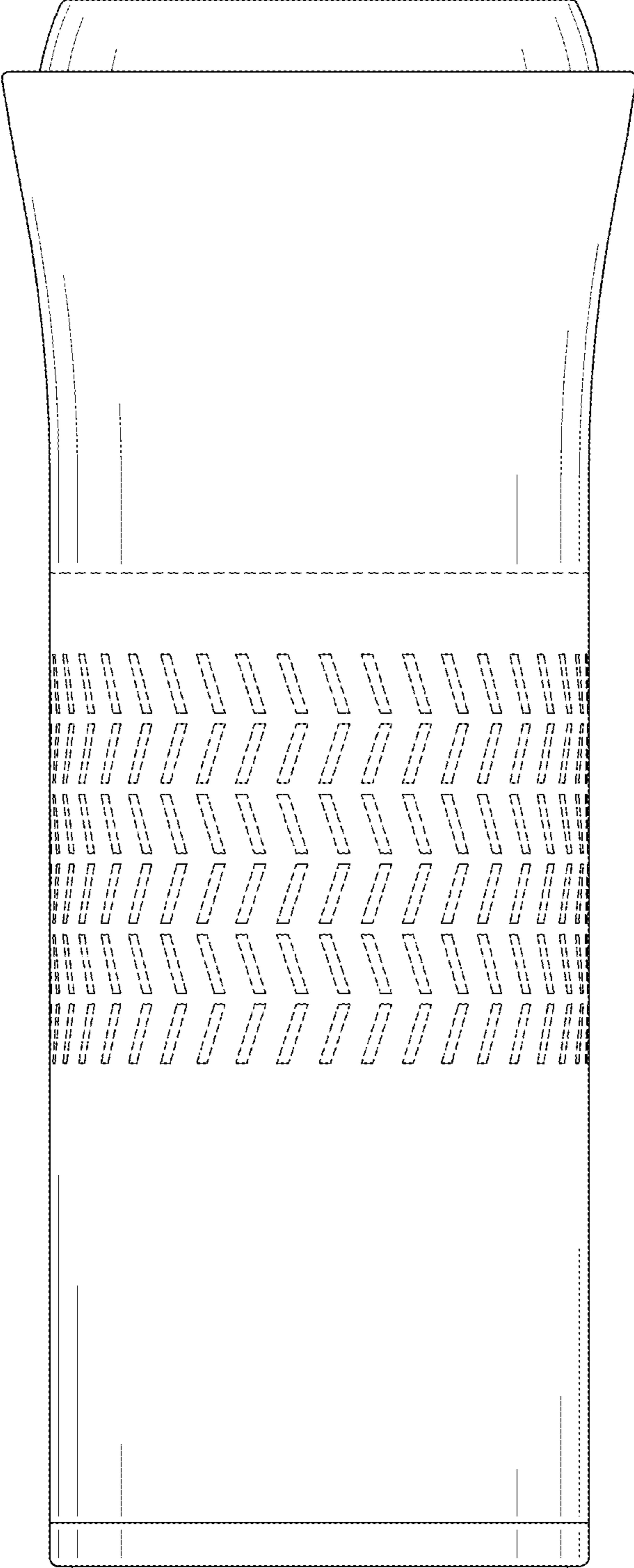

FIG. 3

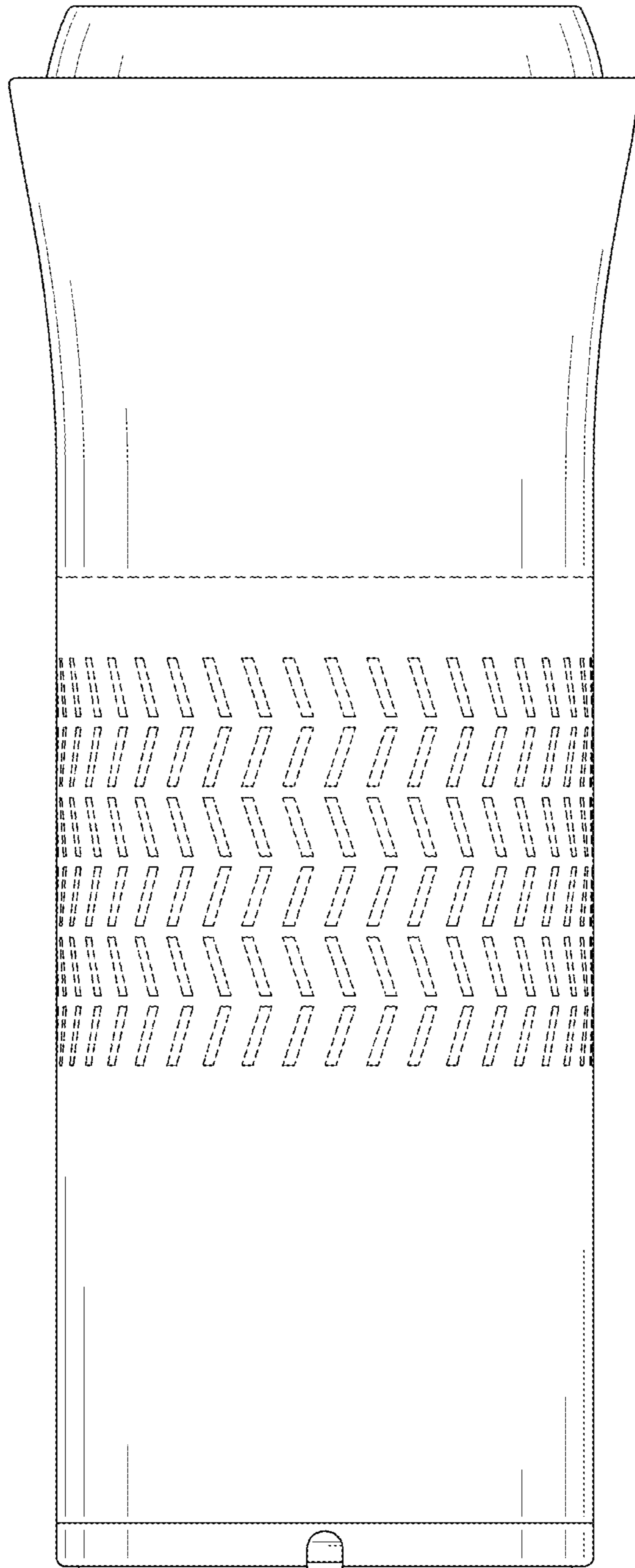

FIG. 4

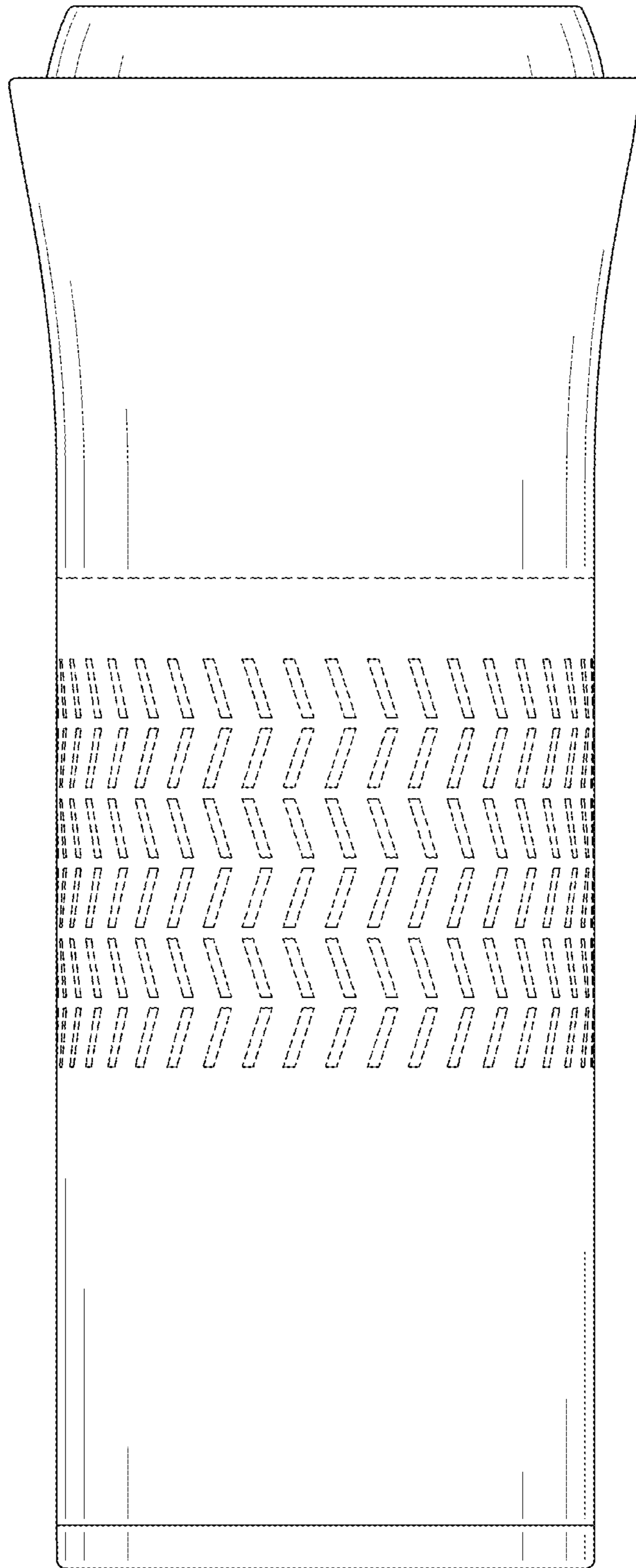

FIG. 5

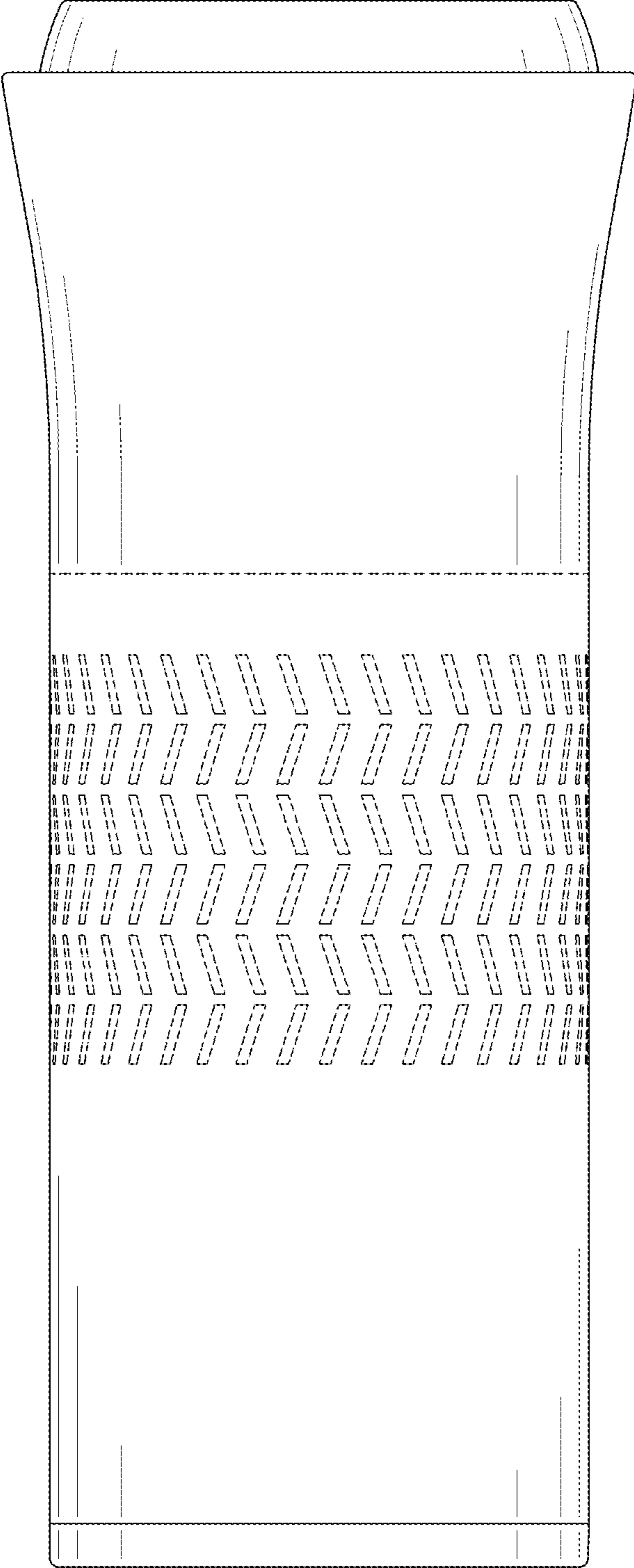

FIG. 6

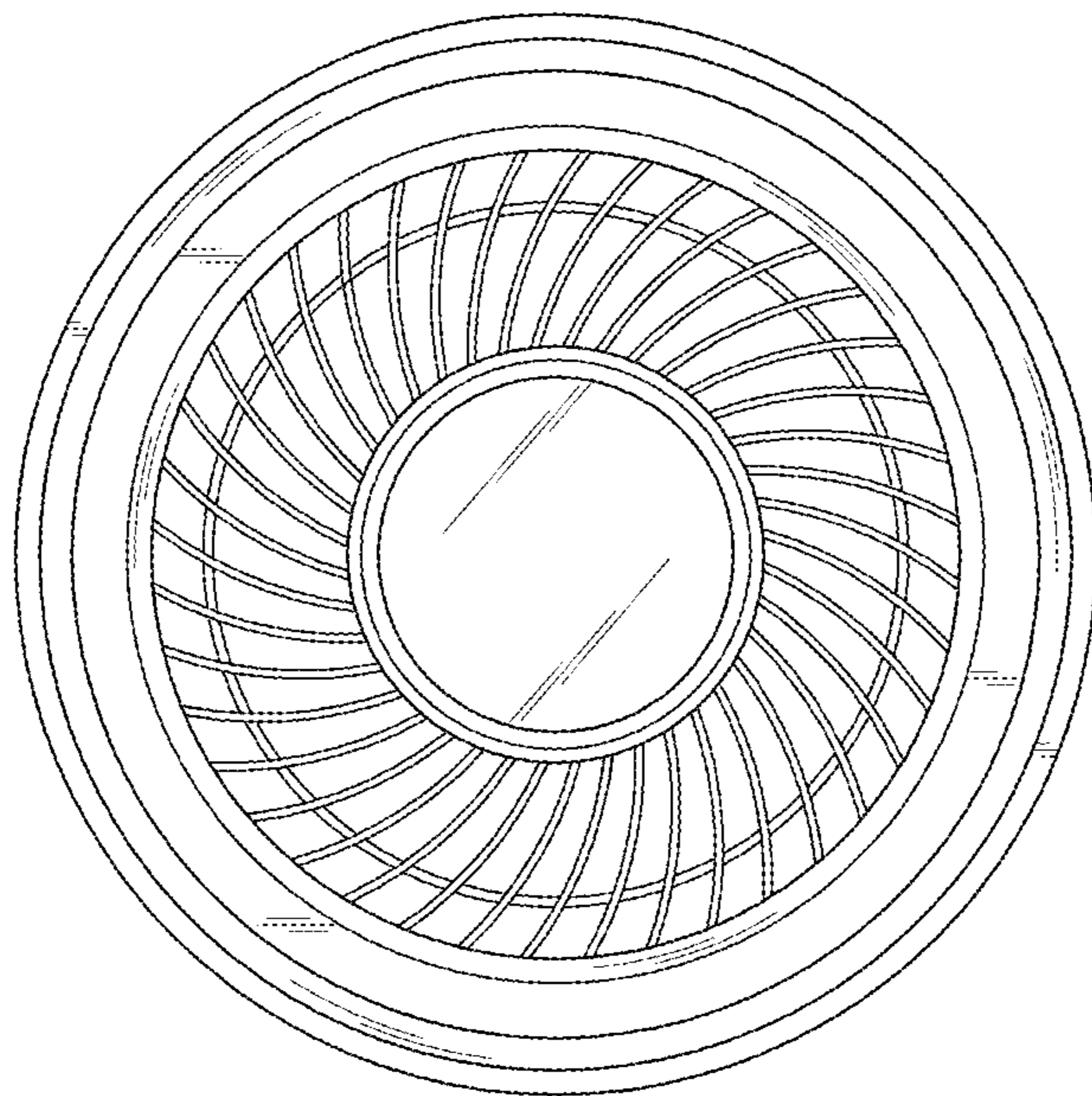

FIG. 7

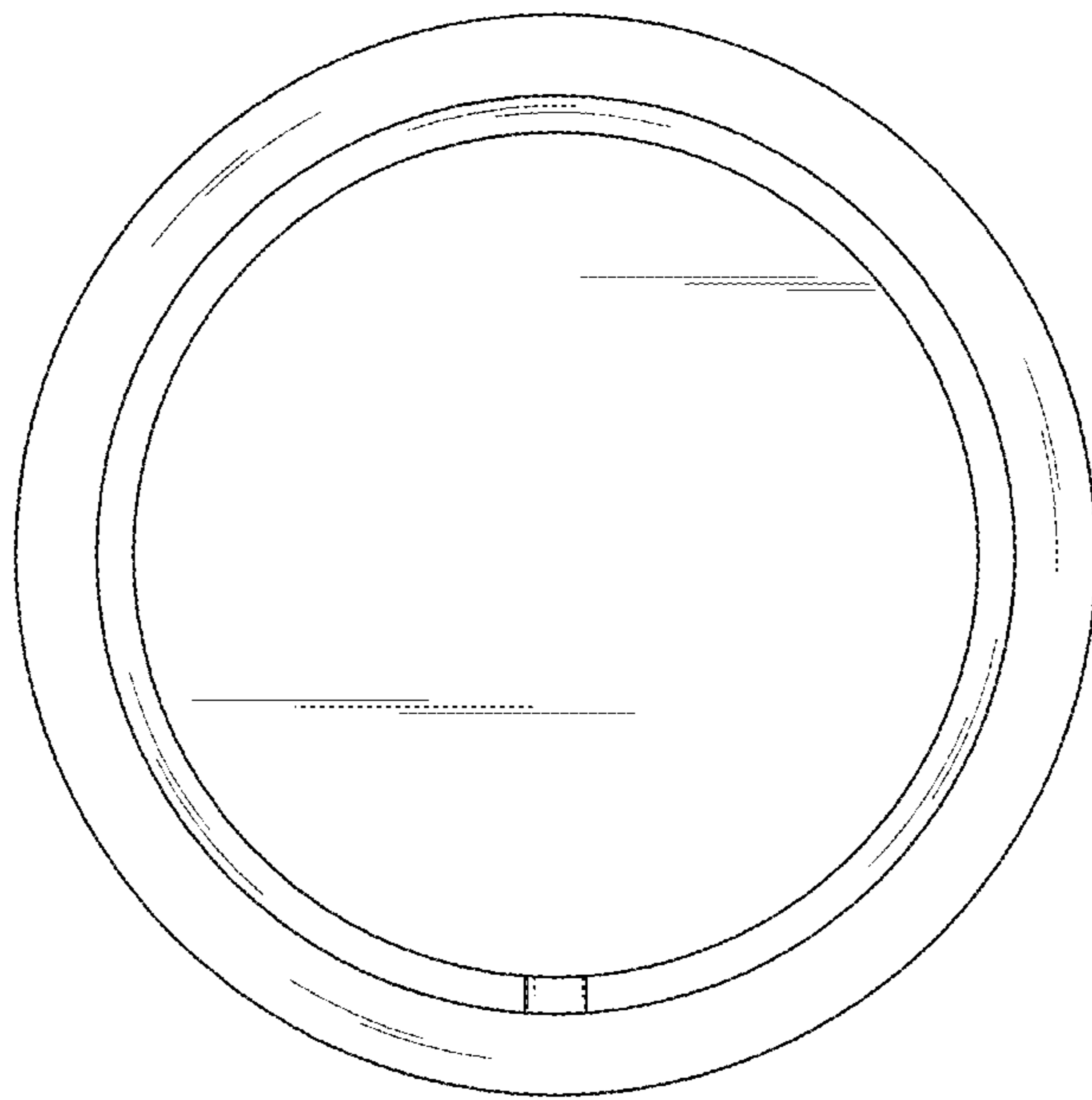

FIG. 8

