



US00D981362S

(12) **United States Design Patent** (10) **Patent No.:** **US D981,362 S**
Dyson et al. (45) **Date of Patent:** **** Mar. 21, 2023**

(54) **MINI SPEAKER**

FOREIGN PATENT DOCUMENTS

(71) Applicant: **N2M Limited**, Bristol (GB)

CN 202130115537.3 * 7/2021

(72) Inventors: **Matthew Richard Dyson**, Bristol (GB);
Nicholas Andrew Webb, Bristol (GB)

OTHER PUBLICATIONS

(73) Assignee: **N2M Limited**, Bristol (GB)

[Rockit Wooshh Instruction video Russian], announced in YouTube on Nov. 31, 2021 [online], [site visited Jun. 16, 2022], Available from the internet URL: <https://www.youtube.com/watch?v=AyqMbHSGozg> (Year: 2021).*

(**) Term: **15 Years**

* cited by examiner

(21) Appl. No.: **29/774,530**

(22) Filed: **Mar. 17, 2021**

Primary Examiner — Khawaja Anwar

Assistant Examiner — Megan Tiana Rakos

(51) **LOC (14) Cl.** **14-01**

(74) *Attorney, Agent, or Firm* — Crose Law LLC;
Bradley D. Crose

(52) **U.S. Cl.**

USPC **D14/204**

(58) **Field of Classification Search**

(57) **CLAIM**

USPC D14/496, 204, 197, 203.2, 207, 211;
D21/329

The ornamental design for a mini speaker, as shown and described.

CPC H04R 1/01; H04R 1/02; H04R 1/403
See application file for complete search history.

DESCRIPTION

(56) **References Cited**

FIG. 1 is a front perspective view of a mini speaker, showing our design;

U.S. PATENT DOCUMENTS

FIG. 2 is a front view thereof;

FIG. 3 is a back view thereof;

D405,475 S *	2/1999	Yokoi	D21/329
D406,613 S *	3/1999	Nakanishi	D21/329
D407,760 S *	4/1999	Yokoi	D21/329
D428,447 S *	7/2000	Tang	D21/329
D439,620 S *	3/2001	Podd	D21/329
D537,813 S *	3/2007	Hoehn	D14/207
D655,306 S *	3/2012	McKenzie	D21/333
D699,707 S *	2/2014	Di Rocco	D12/207
D845,181 S *	4/2019	Dyson	D12/133

FIG. 4 is a left side view thereof;

FIG. 5 is a right side view thereof;

FIG. 6 is a top view thereof; and,

FIG. 7 is a bottom view thereof.

The broken lines shown in the drawings illustrate portions of the mini speaker and form no part of the claimed design.

1 Claim, 7 Drawing Sheets

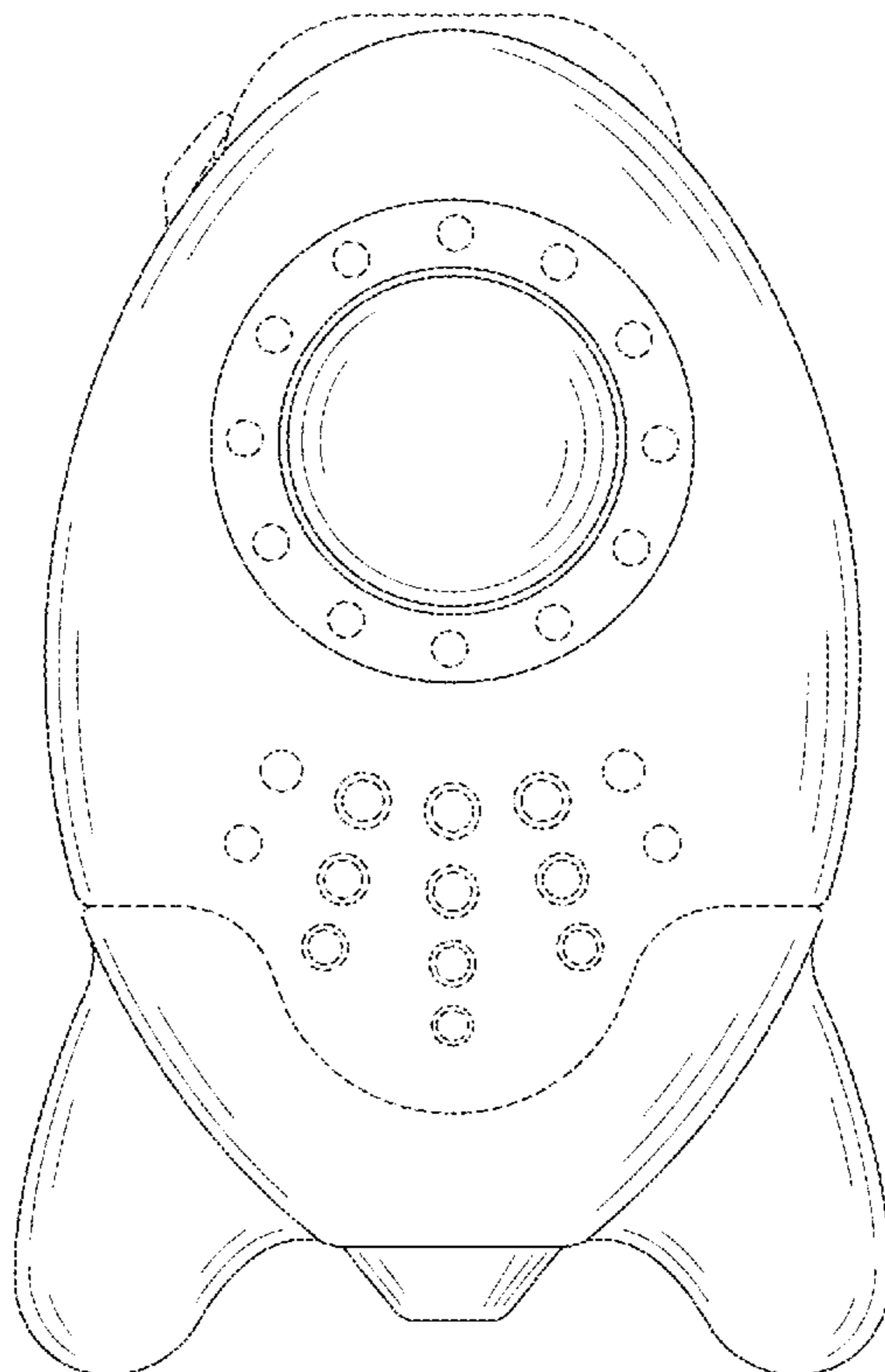

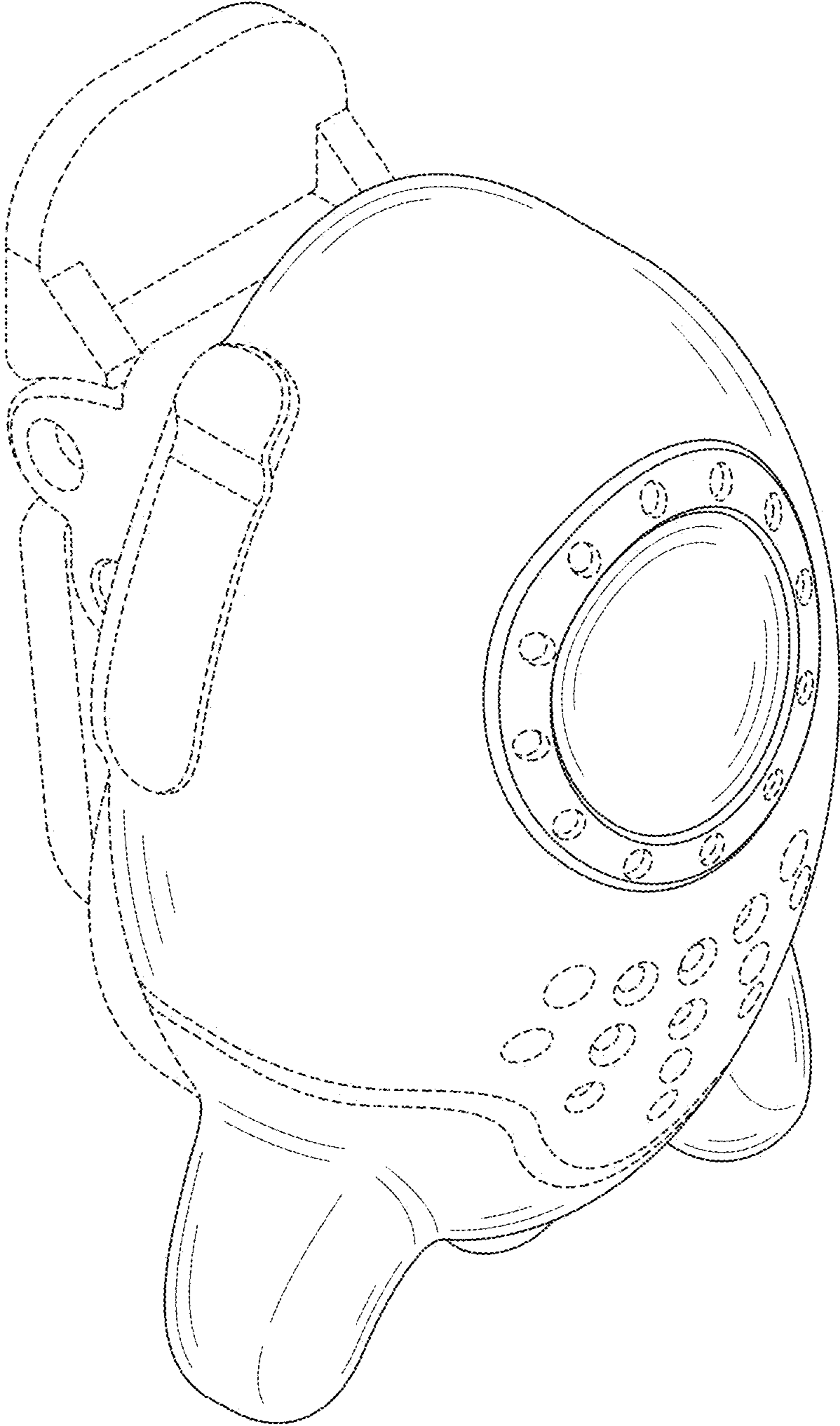

FIG. 1

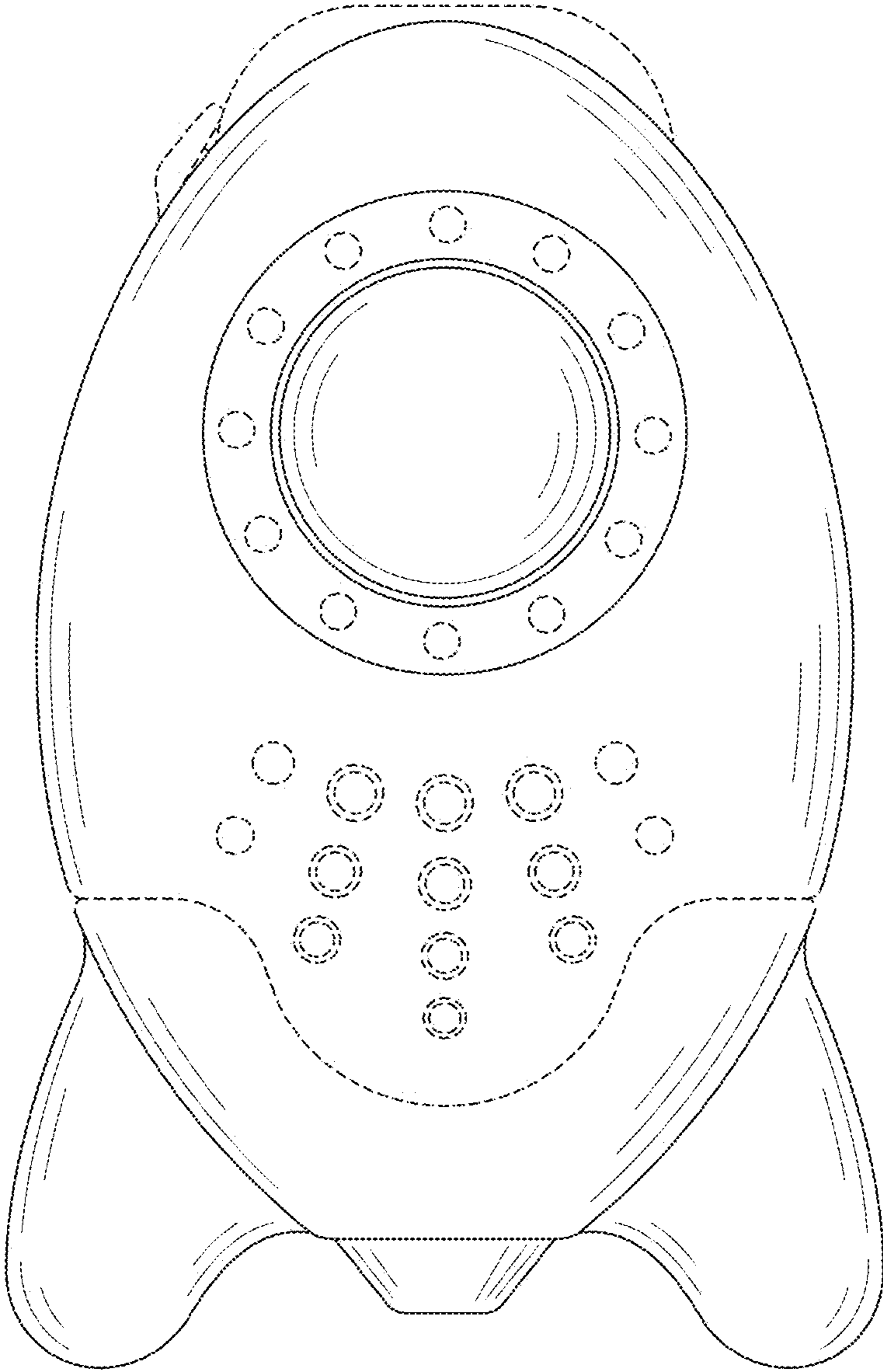

FIG. 2

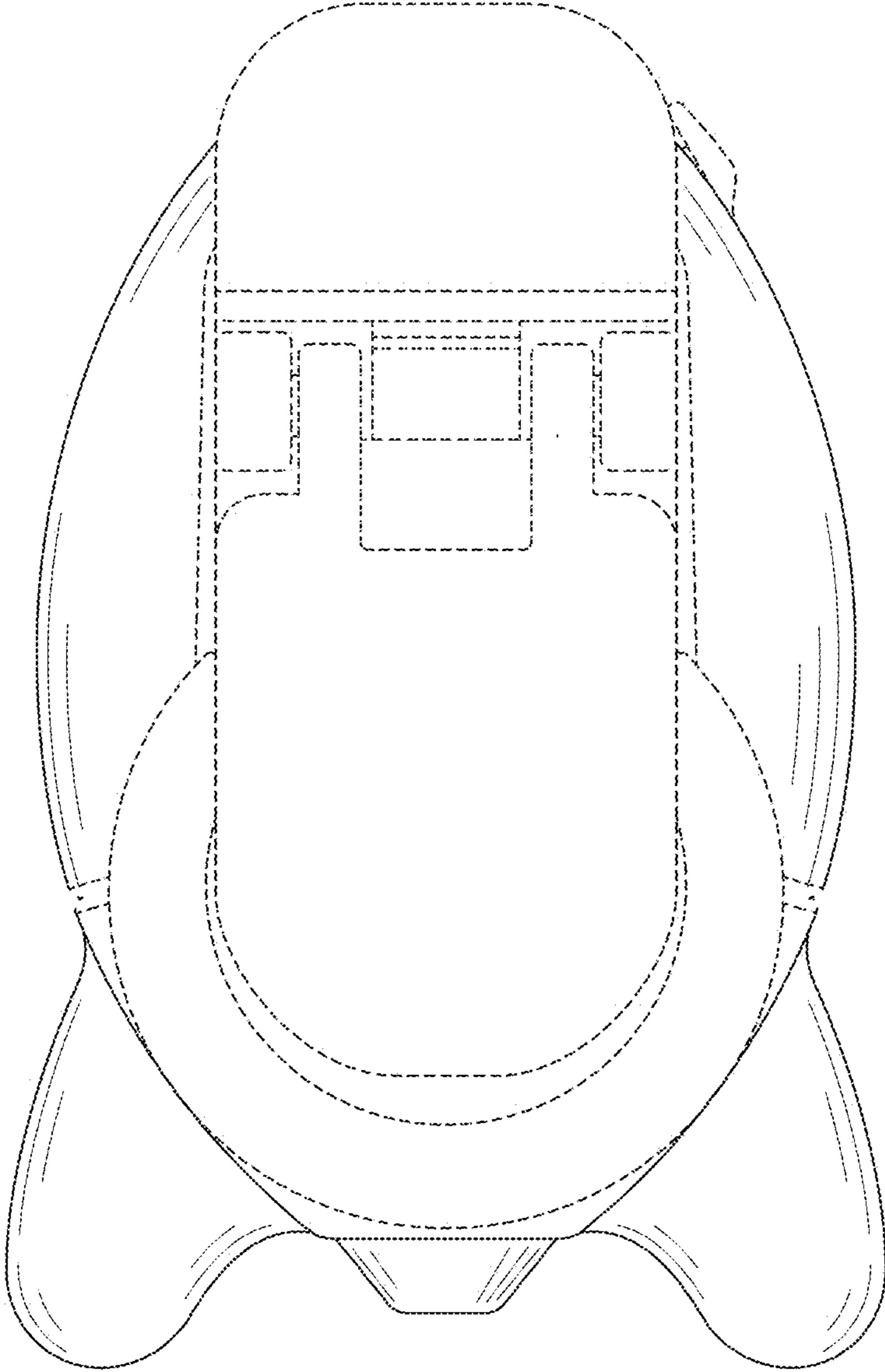

FIG. 3

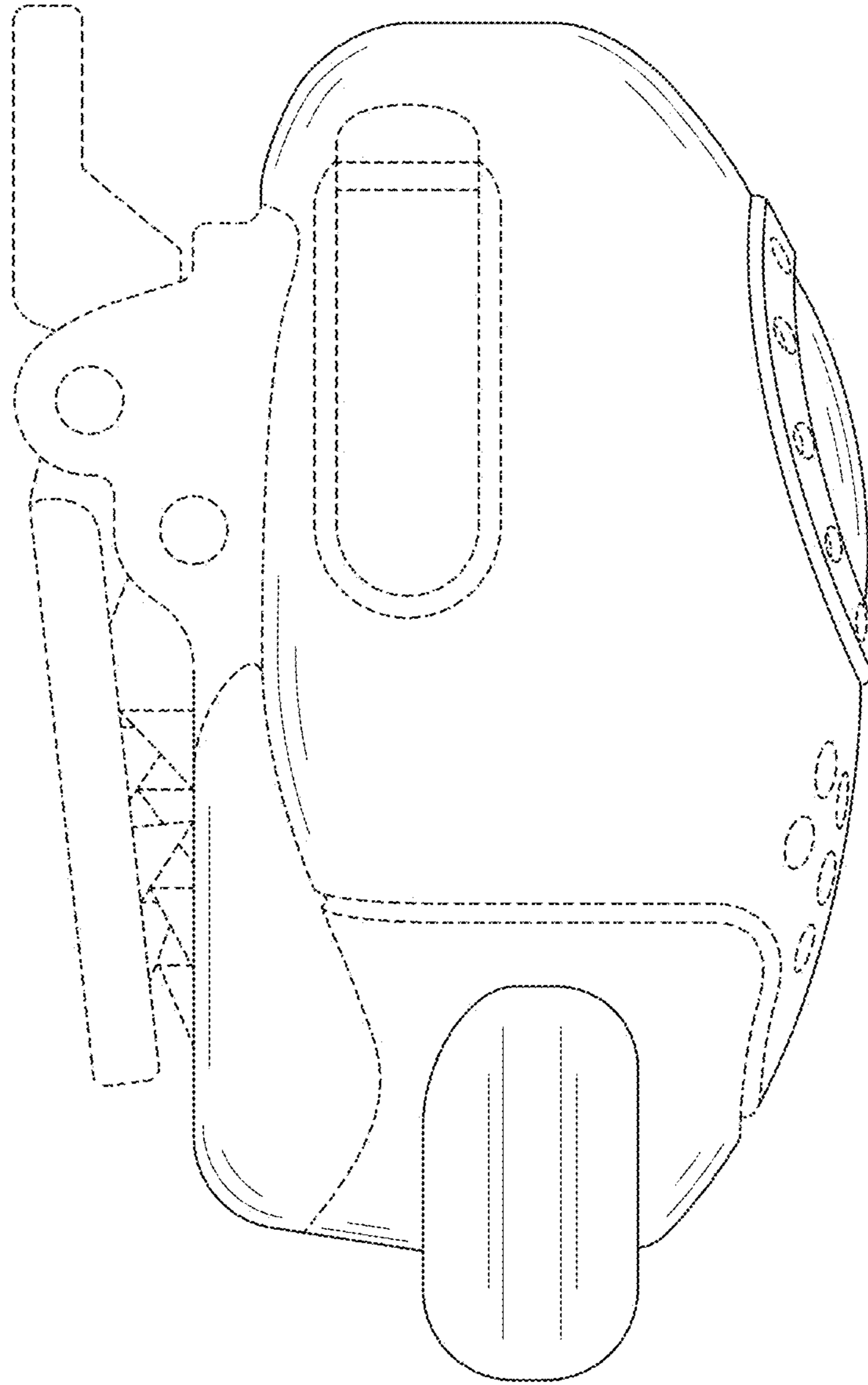

FIG. 4

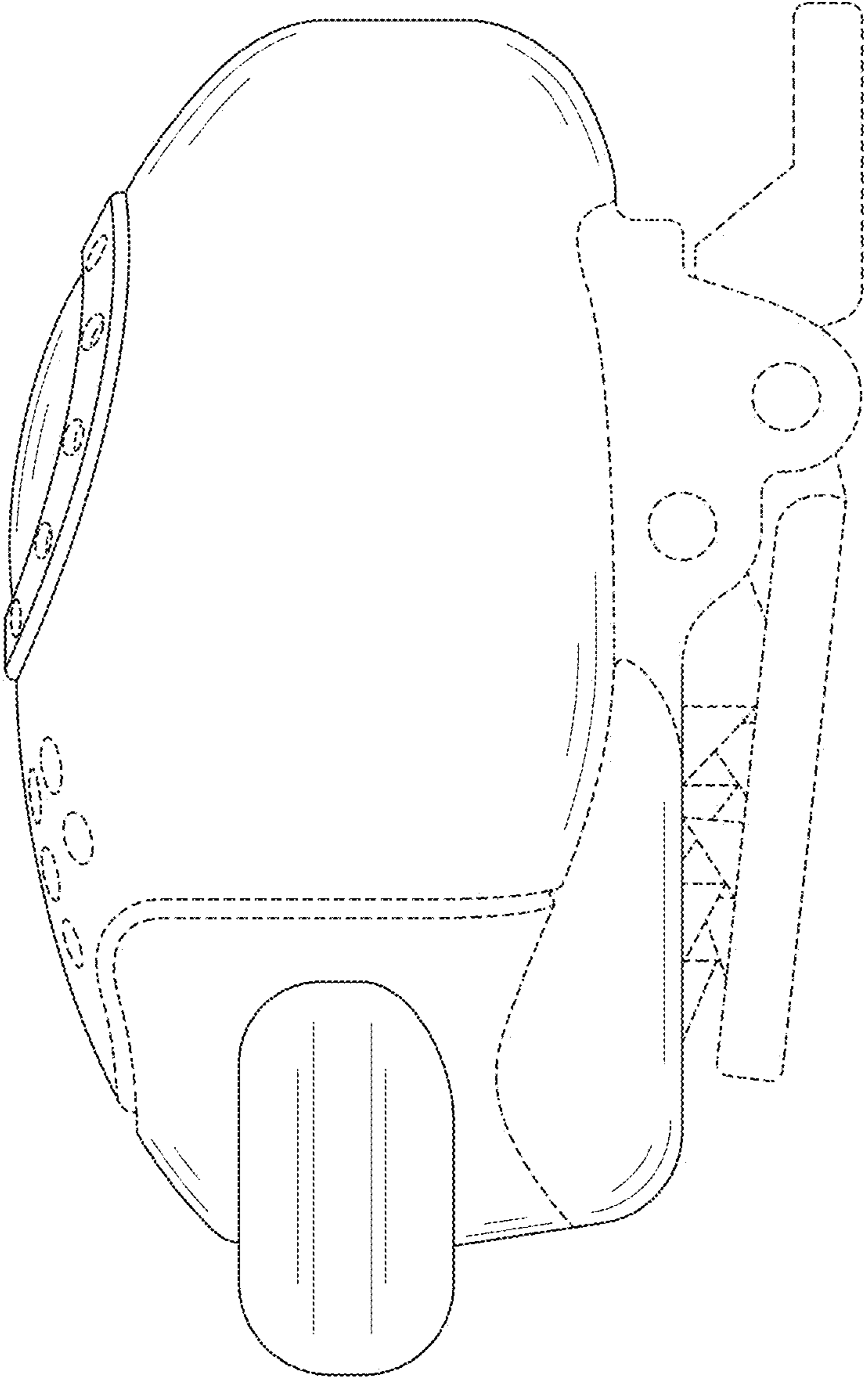

FIG. 5

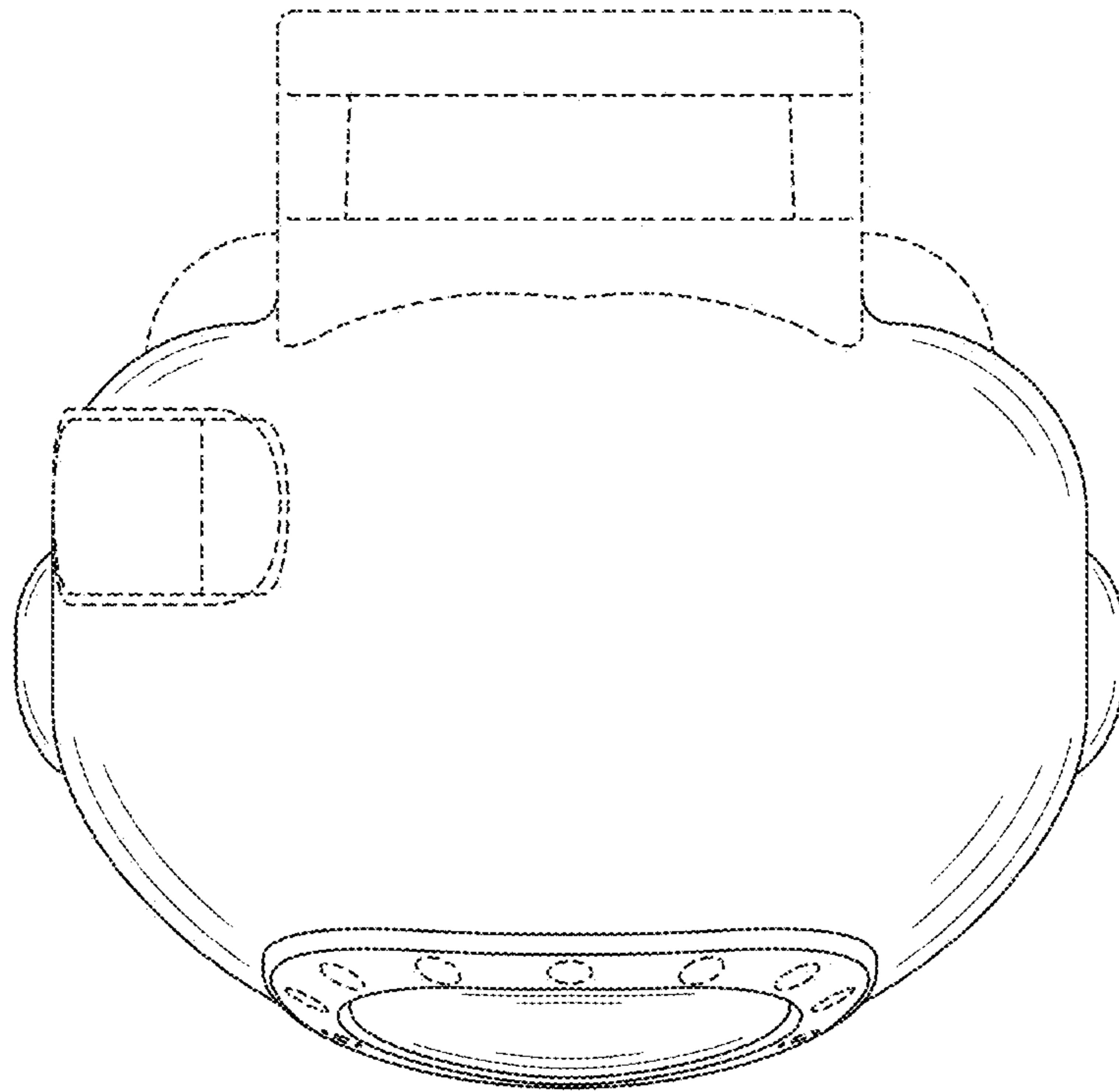

FIG. 6

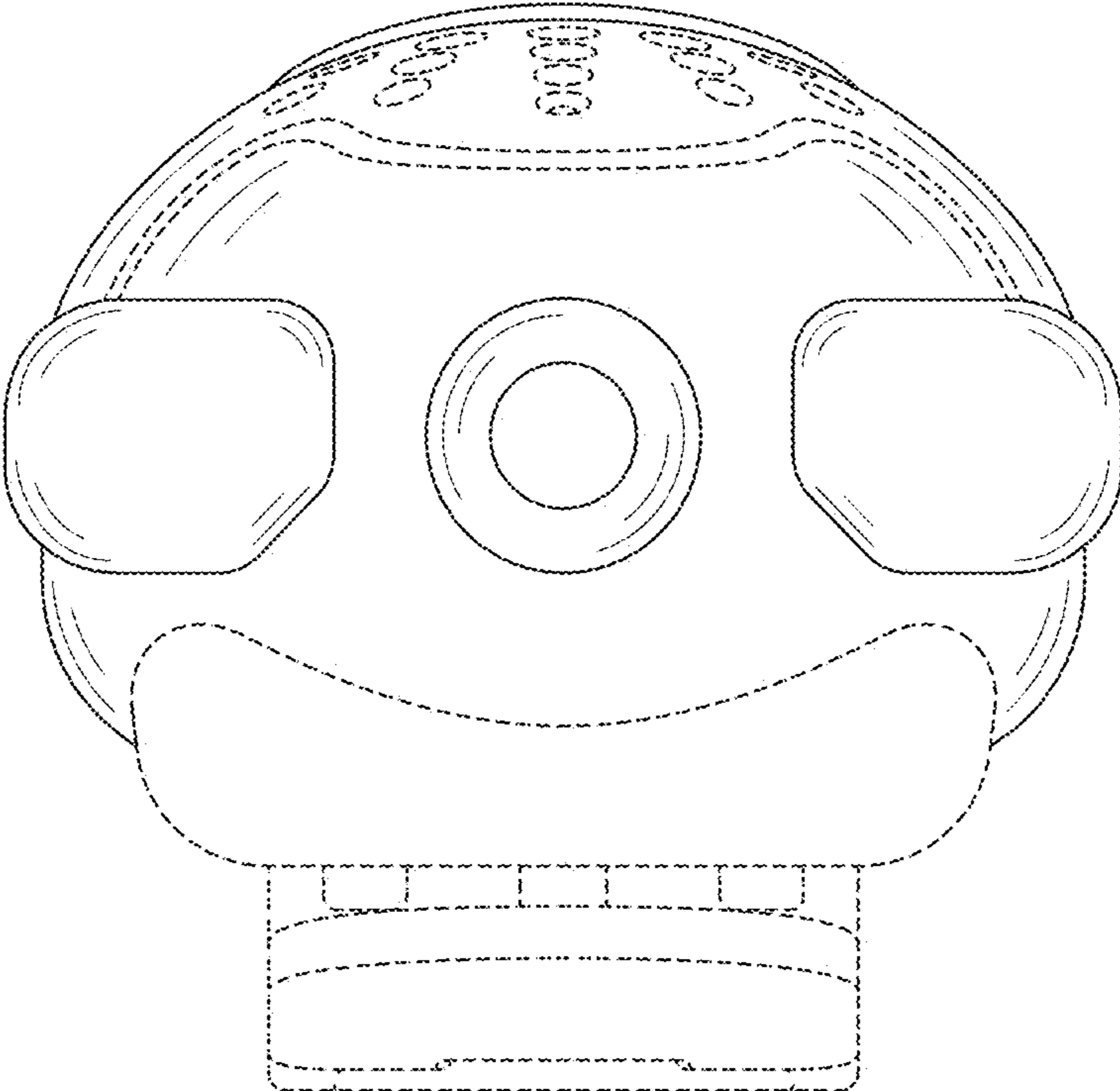

FIG. 7