



US00D981333S

(12) **United States Design Patent** (10) **Patent No.:** **US D981,333 S**
Underhill et al. (45) **Date of Patent:** **** Mar. 21, 2023**

(54) **JUMP STARTER**
(71) Applicant: **THE NOCO COMPANY**, Glenwillow, OH (US)
(72) Inventors: **Derek Michael Underhill**, Tempe, AZ (US); **Jonathan Lewis Nook**, Gates Mills, OH (US)
(73) Assignee: **The Noco Company**, Glenwillow, OH (US)

D465,764 S 11/2002 Salazar
D483,721 S 12/2003 Kim
D485,810 S 1/2004 Fiocchi
D511,743 S 11/2005 Hriscu
D524,731 S 7/2006 Navarrez
D570,772 S 6/2008 Mahaffey
D575,225 S 8/2008 Ahlgren
D580,853 S 11/2008 Ahlgren
D597,029 S 7/2009 Li
D624,014 S 9/2010 Lingott
D634,313 S 3/2011 Fitzpatrick et al.
(Continued)

(**) Term: **15 Years**

(21) Appl. No.: **29/759,036**

(22) Filed: **Nov. 19, 2020**

(51) **LOC (14) Cl.** **13-02**

(52) **U.S. Cl.**
USPC **D13/107**

(58) **Field of Classification Search**
USPC D13/103, 104, 107, 108, 110, 118, 119, D13/120, 137.1, 137.3, 137.4, 138.1, 183
CPC . F02N 11/12; F02N 11/14; H02J 15/00; H02J 50/05
See application file for complete search history.

(56) **References Cited**

U.S. PATENT DOCUMENTS

4,057,313 A	11/1977	Polizzano
D307,579 S	5/1990	Layne
5,019,767 A	5/1991	Shirai et al.
D336,281 S	6/1993	Nakamura
5,585,992 A	12/1996	Wu
5,795,182 A	8/1998	Jacob
5,820,407 A	10/1998	Morse
5,833,493 A	11/1998	Hung
5,847,541 A	12/1998	Hahn
5,985,481 A	11/1999	Champagne
6,002,235 A	12/1999	Clore
6,386,907 B1	5/2002	Ruffa
6,471,540 B1	10/2002	Fernandez

OTHER PUBLICATIONS

“NOCO Boost Max GB251”. Found online Mar. 16, 2022 at amazon.com. Reference dated Jan. 27, 2021. Retrieved from https://www.amazon.com/NOCO-GB251-UltraSafe-Commercial-32-Liters/dp/B08V73BZ42. (Year: 2021).*

(Continued)

Primary Examiner — Kendra Leslie Hamilton

Assistant Examiner — Amanda Christensen

(74) *Attorney, Agent, or Firm* — Jones Day

(57) **CLAIM**

The ornamental design for a jump starter, as shown and described.

DESCRIPTION

FIG. 1 is a top, front, left side perspective view of a jump starter, showing our new design;
FIG. 2 is a top plan view thereof;
FIG. 3 is a bottom plan view thereof;
FIG. 4 is a front elevational view thereof;
FIG. 5 is a rear elevational view thereof;
FIG. 6 is a right side elevational view thereof; and,
FIG. 7 is a left side elevational view thereof.
The broken lines in the drawings depict portions of the jump starter that form no part of the claimed design.

1 Claim, 7 Drawing Sheets

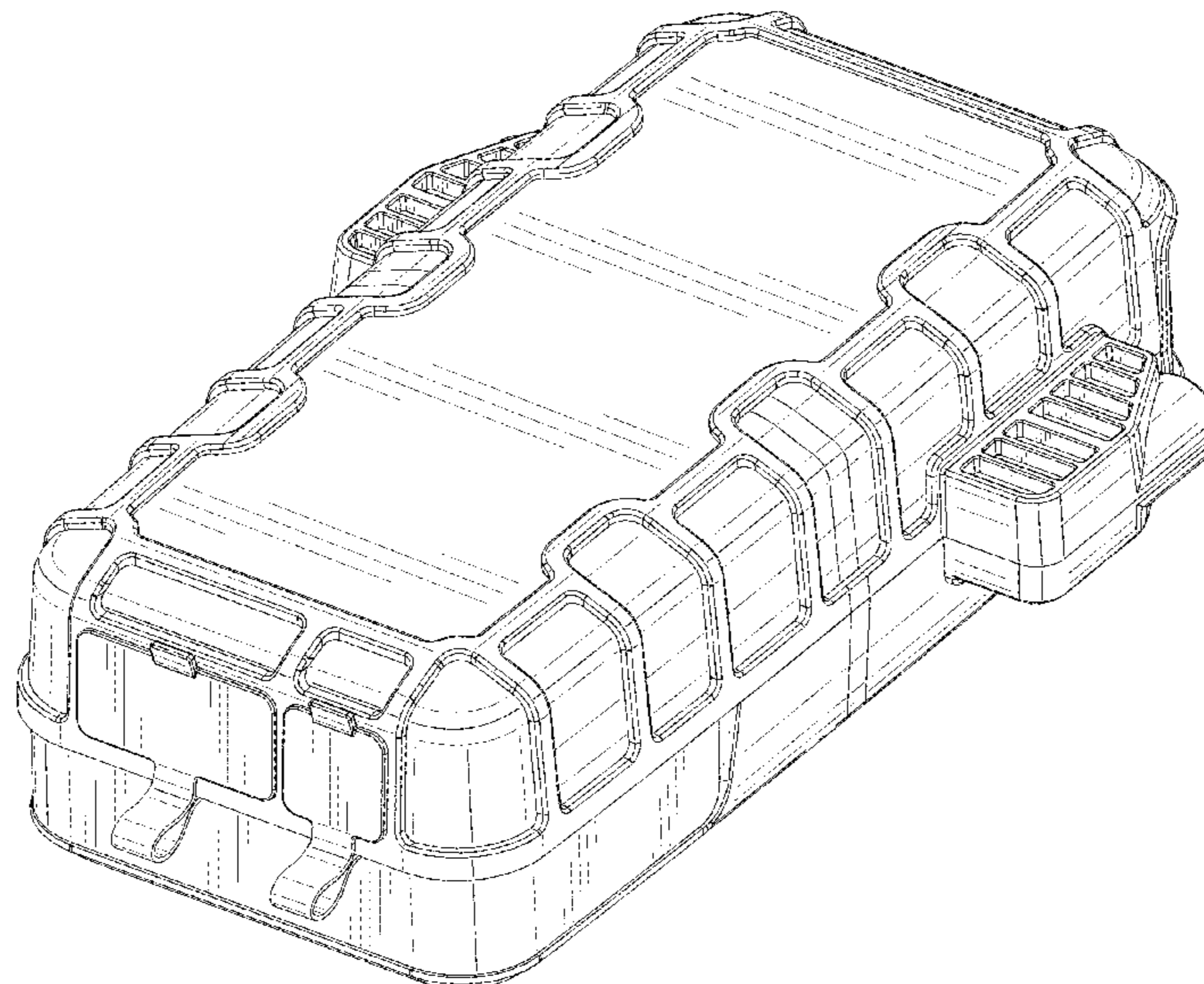

(56)

References Cited

U.S. PATENT DOCUMENTS

D654,854 S 2/2012 Inskip
 D654,855 S 2/2012 Inskip
 D654,856 S 2/2012 Inskip
 D654,867 S 2/2012 Huppe
 D661,249 S 6/2012 Smith
 D664,501 S 7/2012 Inskip
 D681,550 S 5/2013 Corbin
 D684,116 S 6/2013 Inskip
 D687,768 S 8/2013 Minamikawa
 D694,176 S 11/2013 Buetow et al.
 D694,180 S 11/2013 Inskip
 D701,490 S 3/2014 Inskip
 D711,821 S 8/2014 Wang
 D731,422 S 6/2015 Aromin
 D738,825 S 9/2015 Nook
 D742,822 S 11/2015 Ju
 D744,942 S 12/2015 Bates
 D745,455 S * 12/2015 Nook D13/107
 D746,770 S 1/2016 Nook
 D746,774 S 1/2016 Nook
 D755,121 S 5/2016 Barajas
 D757,650 S 5/2016 Faust
 D758,302 S 6/2016 Walker
 D758,960 S 6/2016 Johansson
 D760,164 S 6/2016 Aida
 D769,188 S 10/2016 Miller
 D775,587 S 1/2017 Barajas
 D785,563 S 5/2017 Yang
 D786,192 S 5/2017 Liu
 D786,790 S 5/2017 Miller
 D787,443 S 5/2017 Chiang
 D793,955 S 8/2017 Yang
 D797,044 S 9/2017 Miller
 D803,151 S 11/2017 Zhou
 D808,653 S 1/2018 Rayeski
 D809,454 S 2/2018 Zhou
 D813,162 S * 3/2018 Krantz D13/110
 D814,406 S 4/2018 Yang
 D816,024 S 4/2018 Yang
 D821,306 S * 6/2018 Liu D13/107
 D828,295 S 9/2018 Li
 D829,647 S 10/2018 Yang
 D832,207 S 10/2018 Gorin
 D832,781 S 11/2018 Nook
 D836,064 S 12/2018 Liu
 D836,067 S 12/2018 Tschopp
 D836,068 S 12/2018 Nook
 D838,669 S 1/2019 Miller
 D840,927 S 2/2019 Inskip
 D842,238 S 3/2019 Qiu
 D845,230 S 4/2019 Nook
 D845,892 S 4/2019 Shum
 D860,177 S 9/2019 Robins
 D861,597 S 10/2019 Gan
 D866,457 S 11/2019 Liu
 D866,463 S 11/2019 Hui
 D867,985 S 11/2019 Nook
 D870,035 S 12/2019 Yang
 D871,322 S 12/2019 Nook
 D872,011 S 1/2020 Rao
 D872,012 S * 1/2020 Rao D13/107
 D881,813 S 4/2020 Nook
 D883,925 S 5/2020 Yoon
 D884,605 S 5/2020 Sun
 D884,608 S 5/2020 Gan
 D885,329 S 5/2020 Gan
 D892,726 S 8/2020 Wang
 D892,727 S * 8/2020 Gan D13/103
 D896,749 S 9/2020 Wu
 D902,851 S 11/2020 Wu
 D903,588 S 12/2020 Shoemake
 D911,286 S 2/2021 Esses
 D911,936 S 3/2021 Miller
 D911,949 S 3/2021 Sun
 D911,950 S 3/2021 Zhang

D913,917 S 3/2021 Finocchiaro
 D913,931 S 3/2021 Nook
 D916,012 S 4/2021 Finocchiaro
 D916,015 S 4/2021 Li
 D918,830 S 5/2021 Chen
 D919,572 S * 5/2021 Lei D13/110
 D922,945 S 6/2021 Sun
 D923,564 S 6/2021 Liao
 D924,132 S 7/2021 Turksu
 D926,123 S * 7/2021 Zhu D13/107
 D926,124 S 7/2021 Zhu
 D930,578 S 9/2021 Zheng
 D934,793 S * 11/2021 Shu D13/107
 D937,197 S 11/2021 Hao
 D937,762 S 12/2021 Chung
 D937,763 S * 12/2021 Wang D13/107
 D939,435 S 12/2021 Feng
 D942,931 S 2/2022 Fang
 D943,516 S 2/2022 Wang
 D944,191 S 2/2022 Wang
 D960,090 S 8/2022 Underhill et al.
 2006/0201558 A1 9/2006 Marty et al.
 2008/0213653 A1 9/2008 Marukawa et al.
 2009/0237031 A1 9/2009 McSweyn
 2011/0116861 A1 5/2011 Zhang et al.
 2011/0230081 A1 9/2011 Rinehardt
 2013/0164600 A1 6/2013 Rosskamp et al.
 2014/0184898 A1 7/2014 Overliese et al.
 2015/0054336 A1 2/2015 Xinfang
 2015/0099151 A1 4/2015 Lavender
 2016/0072323 A1 3/2016 Miller
 2016/0359352 A1 * 12/2016 Chiu H02J 7/007
 2017/0012448 A1 1/2017 Miller
 2017/0346140 A1 * 11/2017 Koebler H01M 4/525
 2018/0269703 A1 * 9/2018 Nook H01M 50/548
 2018/0342891 A1 11/2018 Nook
 2019/0222042 A1 7/2019 Nook
 2020/0227937 A1 * 7/2020 Lu B60R 16/033
 2021/0075235 A1 3/2021 Nook
 2021/0094428 A1 4/2021 Nook
 2021/0296913 A1 9/2021 Nook

OTHER PUBLICATIONS

“NOCO Boost GB70 Jump Starter”. Found online Mar. 8, 2022 at amazon.com. Reference dated Jan. 1, 2010. Retrieved from https://www.amazon.com/dp/B016UG6PWE?ref=emc_p_m_5_i. (Year: 2010).*

“YONHAN Battery Charger”. Found online Mar. 8, 2022 at amazon.com. Reference dated Jun. 9, 2020. Retrieved from https://www.amazon.com/Automotive-Battery-Automatic-Motorcycle-YONHAN/dp/B089VRXB2W/ref=psdc_15707061_t5_B09HGYMP7D. (Year: 2020).*

U.S. Appl. No. 86/030,590, filed Aug. 6, 2013, including drawing and sample.

“Amazon Basics Battery Charger” Found online Mar. 8, 2022 at amazon.com. Reference dated Jan. 18, 2020. Retrieved from https://www.amazon.com/AmazonBasics-Battery-Charger-Volt-800mA/dp/B07TTNV9LZ/ref=psdc_15707061_t1_B00DJ5KEEA?th=1 (Year: 2020).

“Battery Tender Plus Battery Charger” Found online Mar. 8, 2022 at amazon.com. Reference dated Jan. 20, 2007. Retrieved from https://www.amazon.com/dp/B00DJSKEEA/ref=sspa_dk_detail_8 (Year: 2007).

“BEATIT Jump Starter” Found online May 20, 2021 at amazon.com. Reference dated Dec. 24, 2018. Retrieved from https://www.amazon.com/BEATIT-21000mAh-Portable-Inverter-BP101/dp/B07M9M86JM/ref=psdc_318336011_t5_B084BWGWYHY (Year: 2018).

“Durst Battery Charger” Found online Apr. 4, 2022 at durst.com.au. Reference dated Mar. 9, 2010. Retrieved from https://tineye.com/search/1ec8ff6116e1710356e88efedb9dfccdcbe769?sort=crawl_date&order=asc&page=1 (Year: 2010).

“MOTOPOWER Battery Charger” Found online Mar. 8, 2022 at amazon.com. Reference dated Dec. 2, 2017. Retrieved from <https://>

(56)

References Cited

OTHER PUBLICATIONS

www.amazon.com/MOTORPOWER-MP00205A-Automatic-Battery-Maintainer/dp/B06XWDZ2KQ/ref=pd_day0fbt_img_2/133-437029-9147658 (Year: 2017).

“NOCO Genius G750 Battery Charger” Found online Mar. 8, 2022 at youtube.com. Reference dated Jul. 10, 2015. Retrieved from <https://www.youtube.com/watch?v=LnBf30-5lyU> (Year: 2015).

“NOCO Boost Pro GB150 Jump Starter” Found online Mar. 8, 2022 at amazon.com. Reference dated Sep. 1, 2015. Retrieved from https://www.amazon.com/dp/B015TKSSB8?ref=emc_p_m_5_i (Year: 2015).

“Noco GBX55 Jump Starter” Found online Mar. 18, 2022 at amazon.com. Reference dated Feb. 22, 2021. Retrieved from <https://www.amazon.com.au/NOCO-GBX55-Ultrasafe-Powerbank-7-5-Liter/dp/B08WZKRHZZ> (Year: 2021).

“NOCO Boost XL GB50 Jump Starter” Found online Mar. 17, 2022 at amazon.com. Reference dated Jan. 16, 2019. Retrieved from <https://www.amazon.com/NOCO-GB50-Ultrasafe-Lithium-Gasoline/dp/B07MVY7K43> (Year: 2019).

“NOCO Genius 2x4 Charger” Found online Apr. 1, 2022 at amazon.com. Reference dated Aug. 15, 2020. Retrieved from <https://www.amazon.com/dp/B08FYS6CL8> (Year: 2020).

“NOCO Genius 2x2 Charger” Found online Mar. 8, 2022 at amazon.com. Reference dated Jul. 31, 2020. Retrieved from https://www.amazon.com/dp/B08F37P7H3?ref=emc_p_m_5_i (Year: 2020).

“NOCO Genius 10 Charger” Found online Mar. 8, 2022 at amazon.com. Reference dated Nov. 18, 2019. Retrieved from https://www.amazon.com.au/NOCO-GENIUSIO-Fully-Automatic-Temperature-Compensation/dp/B07W3QT226/ref=psdc_15707061_t2_B07W8KJH44 (Year: 2019).

“NOCO Genius 5 Smart Charger” Found online Mar. 8, 2022 at amazon.com. Reference dated Nov. 18, 2019. Retrieved from https://www.amazon.com/dp/B07W8KJH44?ref=emc_p_m_5_i (Year: 2019).

“NOCO Genius 1 Charger” Found online Mar. 8, 2022 at amazon.com. Reference dated Nov. 18, 2019. Retrieved from <https://www.amazon.com/NOCO-GENIUS1-Fully-Automatic-Temperature-Compensation/dp/B07W46BX31> (Year: 2019).

“REDARC Battery Charger” Found online Apr. 4, 2022 at allplant.net.au. Reference dated Nov. 4, 2016. Retrieved from https://tineye.com/search/90925c60e27321fa89cba970b4406754770123af?sort=crawl_date&order=asc&page=1 (Year: 2016).

“Renogy On-Board Battery Charger” Found online Apr. 4, 2022 at amazon.com. Reference dated Apr. 2, 2018. Retrieved from <https://www.amazon.com/Renogy-Battery-Batteries-Multi-stage-Charging/dp/B07Q5VYPCF?th=1> (Year: 2018).

“Victron Energy Charger” Found online Apr. 4, 2022 at amazon.com. Reference dated Sep. 27, 2020. Retrieved from https://www.amazon.com/Orion-Tr-12-30A-Isolated-Charger-Booster/dp/B07ZKG396Y/ref+pd_Ipo_2?pd_rd_=B07ZKG396Y&th=1 (Year: 2020).

* cited by examiner

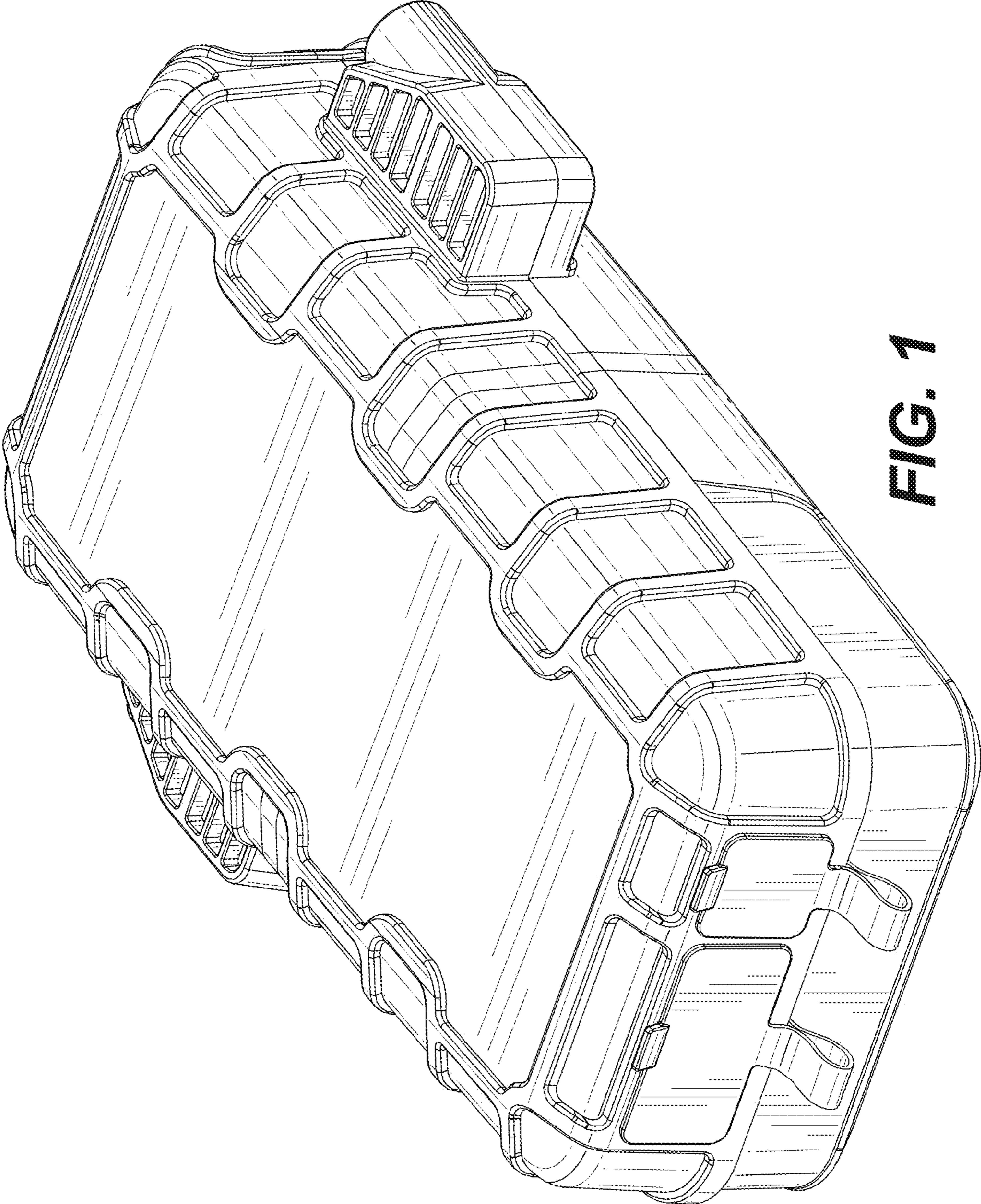

FIG. 1

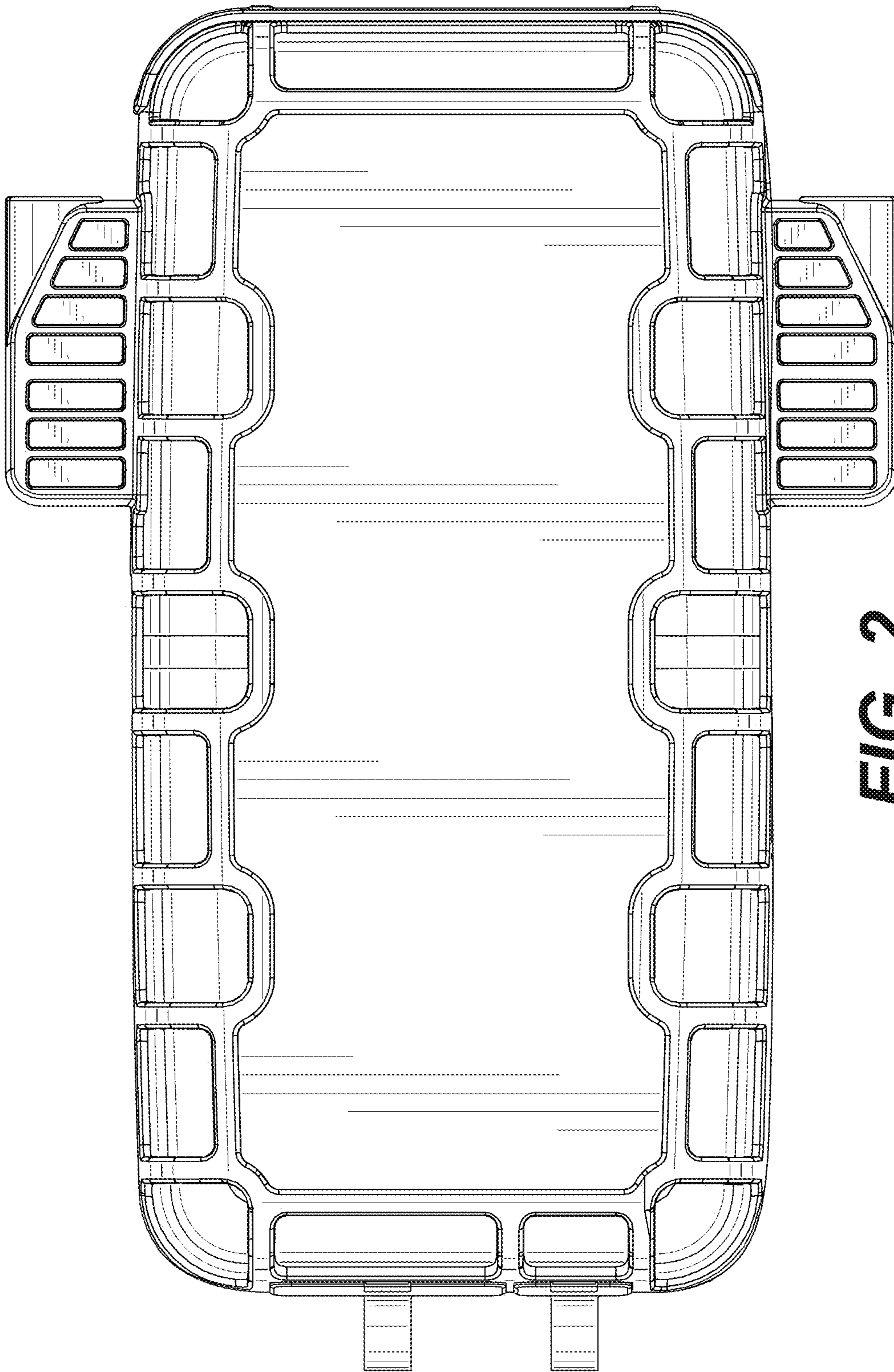

FIG. 2

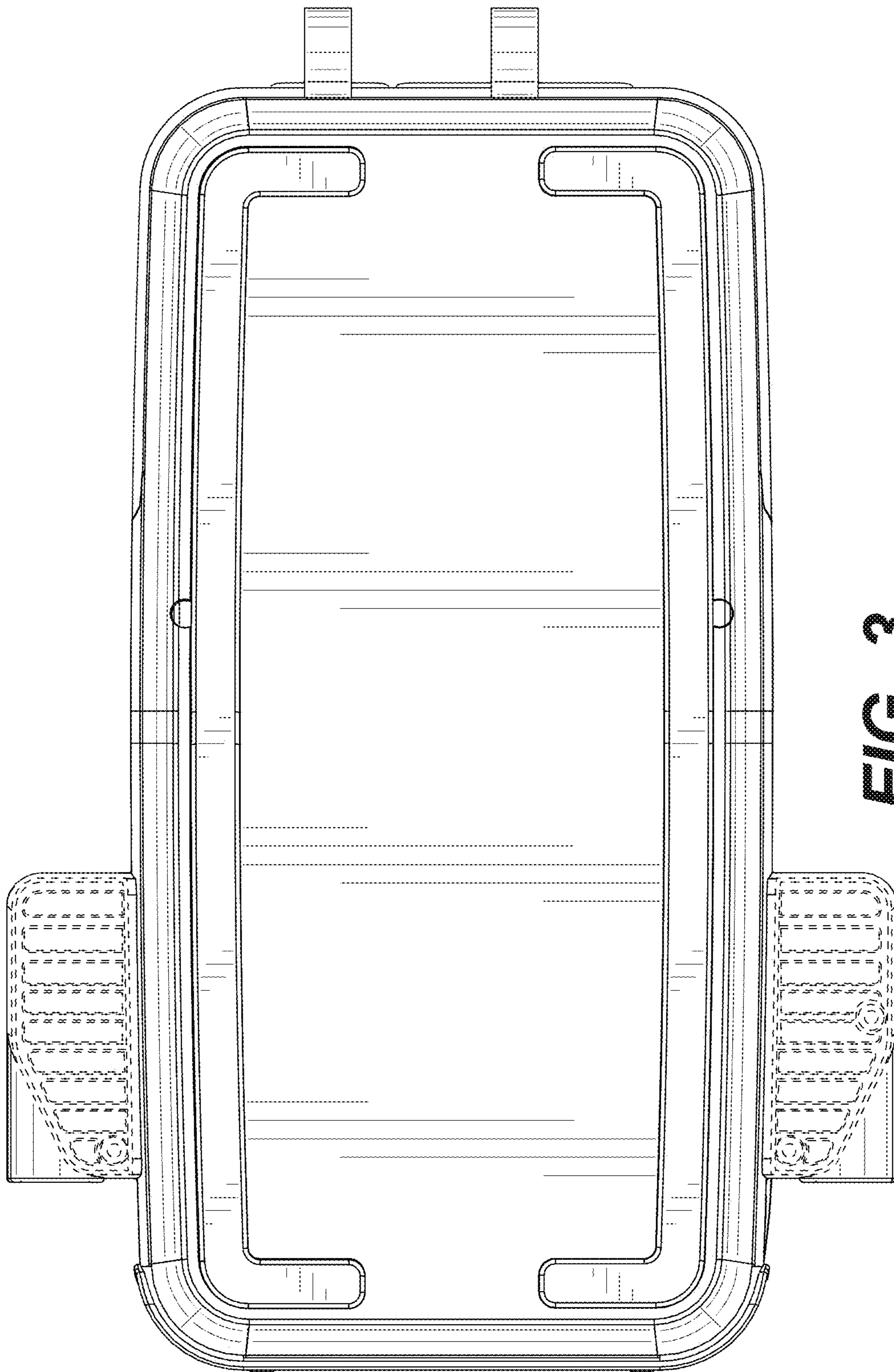

FIG. 3

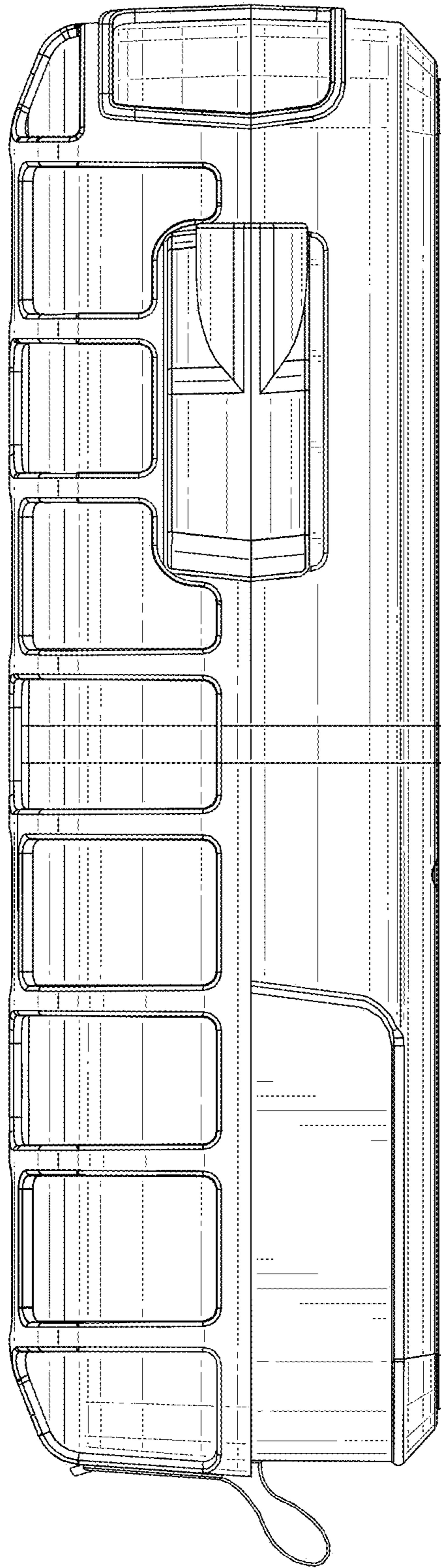

FIG. 4

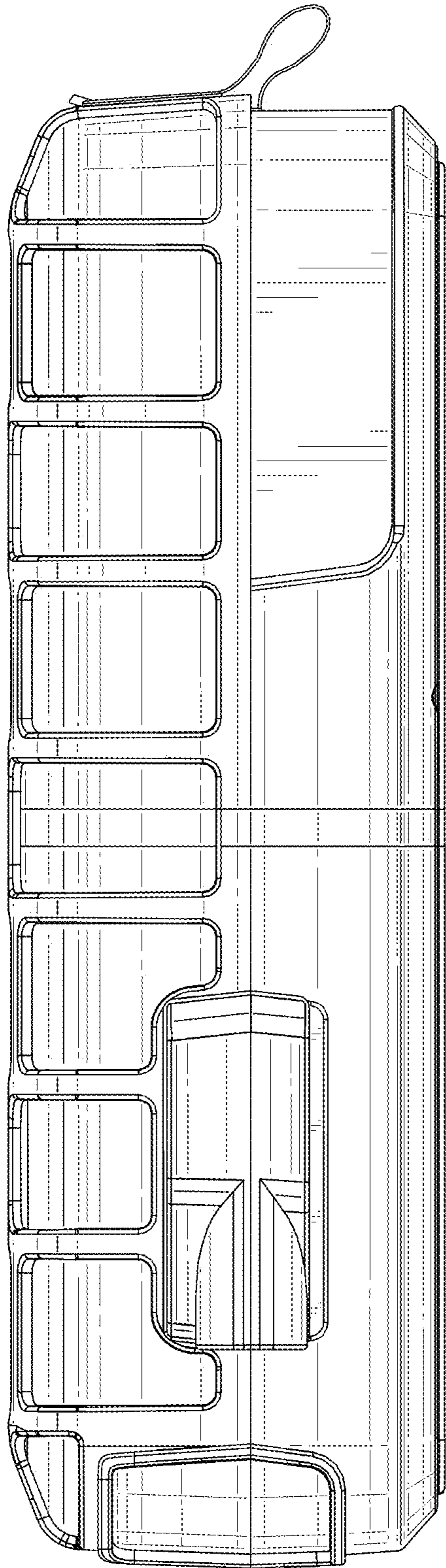

FIG. 5

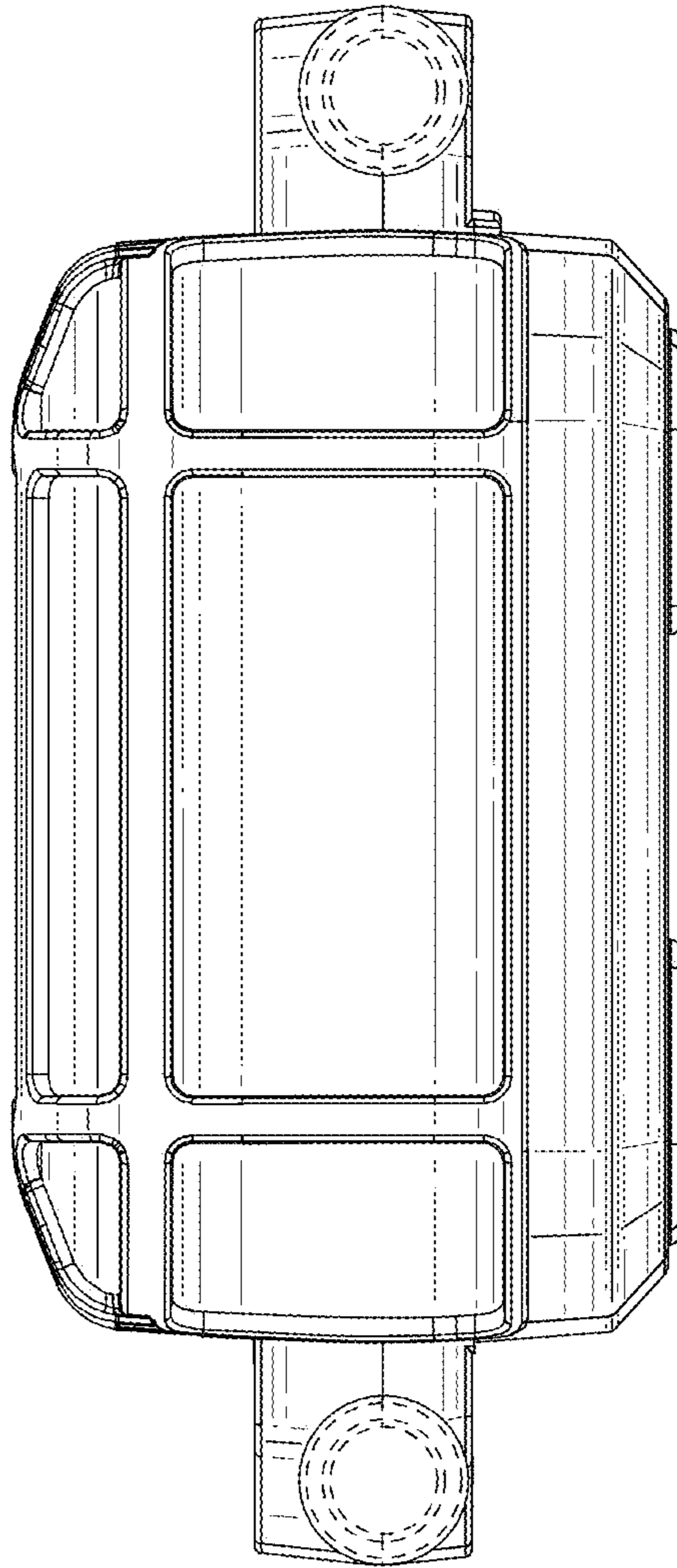

FIG. 6

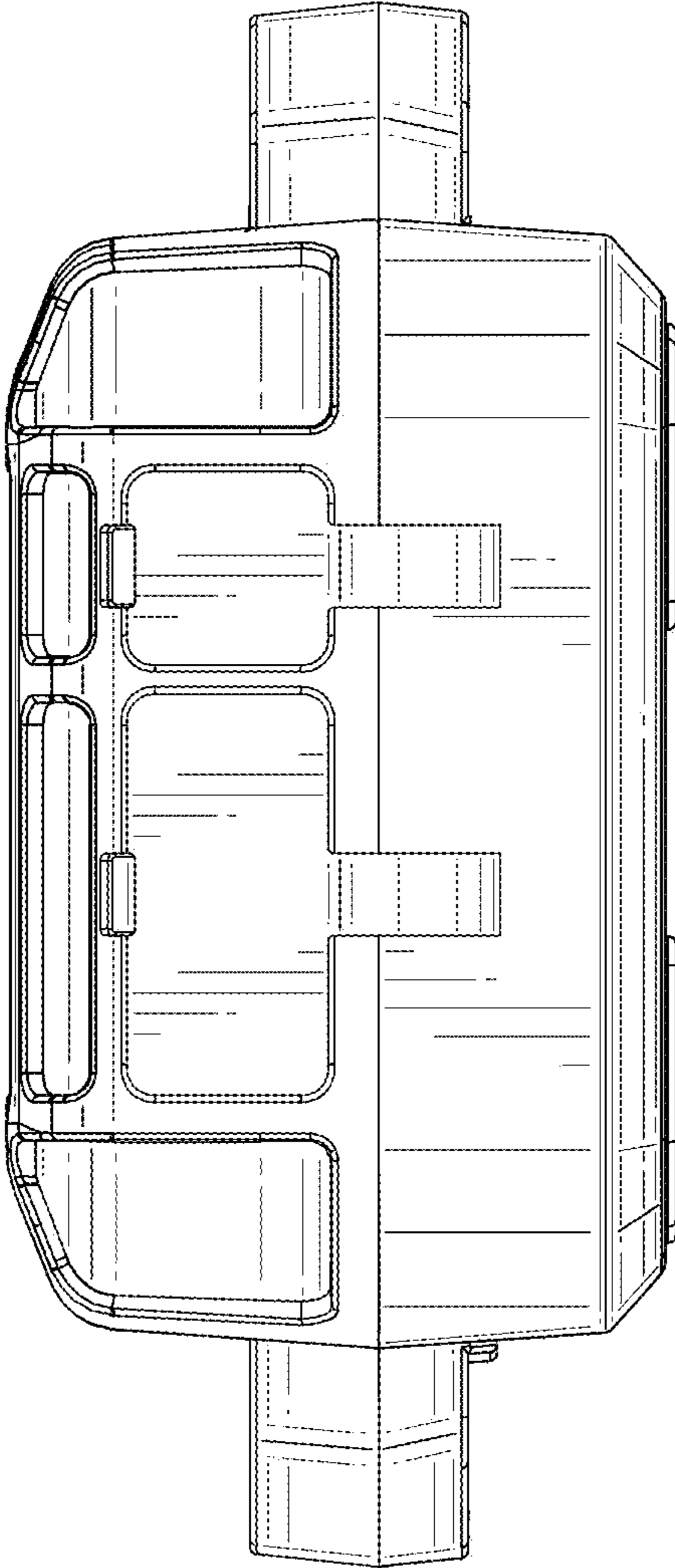

FIG. 7