



US00D981318S

(12) **United States Design Patent**  
**Duan**

(10) **Patent No.:** **US D981,318 S**

(45) **Date of Patent:** **\*\* Mar. 21, 2023**

(54) **WIPER ADAPTER**

(71) Applicant: **Ningbo Meiyi Packaging Products Co., Ltd., Ningbo (CN)**

(72) Inventor: **Yangchun Duan, Ningbo (CN)**

(\*\*) Term: **15 Years**

(21) Appl. No.: **29/857,556**

(22) Filed: **Oct. 24, 2022**

(51) **LOC (14) Cl.** ..... **12-16**

(52) **U.S. Cl.**  
USPC ..... **D12/220**

(58) **Field of Classification Search**  
USPC ..... D12/219, 220  
CPC ..... B60S 1/3801; B60S 1/4003; B60S  
2001/3815

See application file for complete search history.

(56) **References Cited**

**U.S. PATENT DOCUMENTS**

D685,713 S *	7/2013	Wang	.....	D12/219
D686,557 S *	7/2013	Kwon	.....	D12/219
D704,125 S *	5/2014	Kani	.....	D12/219
D704,129 S	5/2014	Depondt		
D706,201 S	6/2014	Depondt		
D706,202 S	6/2014	Depondt		
D809,989 S	2/2018	Lee et al.		
D821,954 S *	7/2018	Hyun	.....	D12/219
D842,213 S	3/2019	Lee et al.		
D871,305 S *	12/2019	Zeng	.....	D12/219
D872,676 S *	1/2020	Depondt	.....	D12/219

D894,813 S *	9/2020	Liang	.....	D12/219
D895,523 S *	9/2020	Tufts, Jr.	.....	D12/220
D896,156 S *	9/2020	Tufts, Jr.	.....	D12/220
D900,000 S	10/2020	Hyun		
D904,275 S	12/2020	Tufts, Jr. et al.		
D953,234 S *	5/2022	Duan	.....	D12/219

\* cited by examiner

*Primary Examiner* — Katrina A Betton

(74) *Attorney, Agent, or Firm* — SciNova IP and Regulatory Consulting LLC; Jingfeng Song

(57) **CLAIM**

The ornamental design for a wiper adapter, as shown and described.

**DESCRIPTION**

FIG. 1 is a front, right, and top perspective view of a wiper adapter, showing my new design;  
 FIG. 2 is a rear, right, and bottom perspective view thereof;  
 FIG. 3 is a front elevational view thereof;  
 FIG. 4 is a rear elevational view thereof;  
 FIG. 5 is a left elevational view thereof;  
 FIG. 6 is a right elevational view thereof;  
 FIG. 7 is a top plan view thereof;  
 FIG. 8 is a bottom plan view thereof; and,  
 FIG. 9 is a front, right, and top perspective view thereof with the cap portion opened.  
 The broken lines in the drawings depict portions of the wiper adapter and form no part of the claimed design.

**1 Claim, 9 Drawing Sheets**

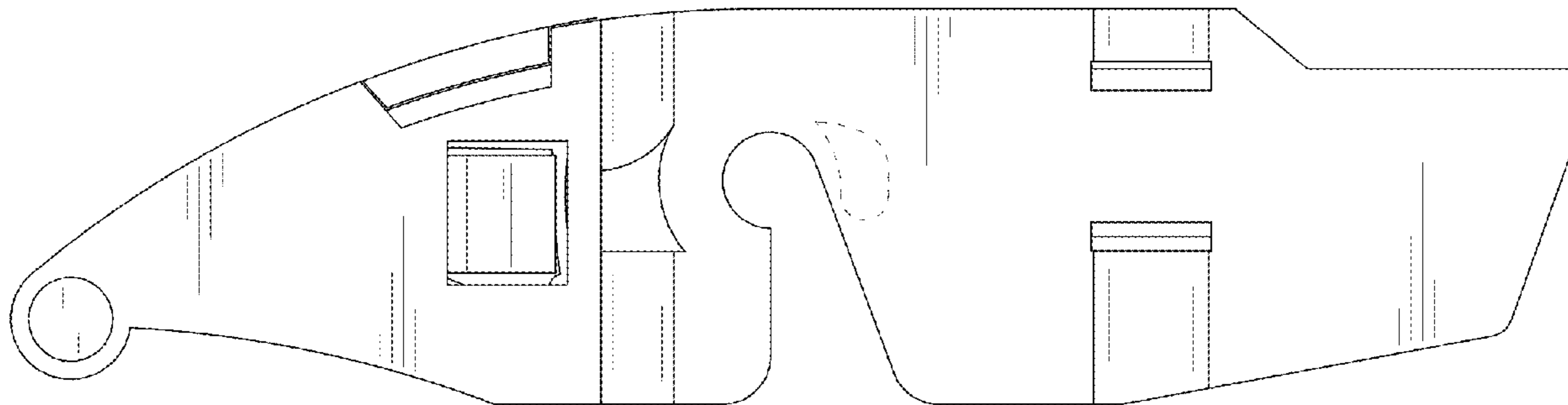

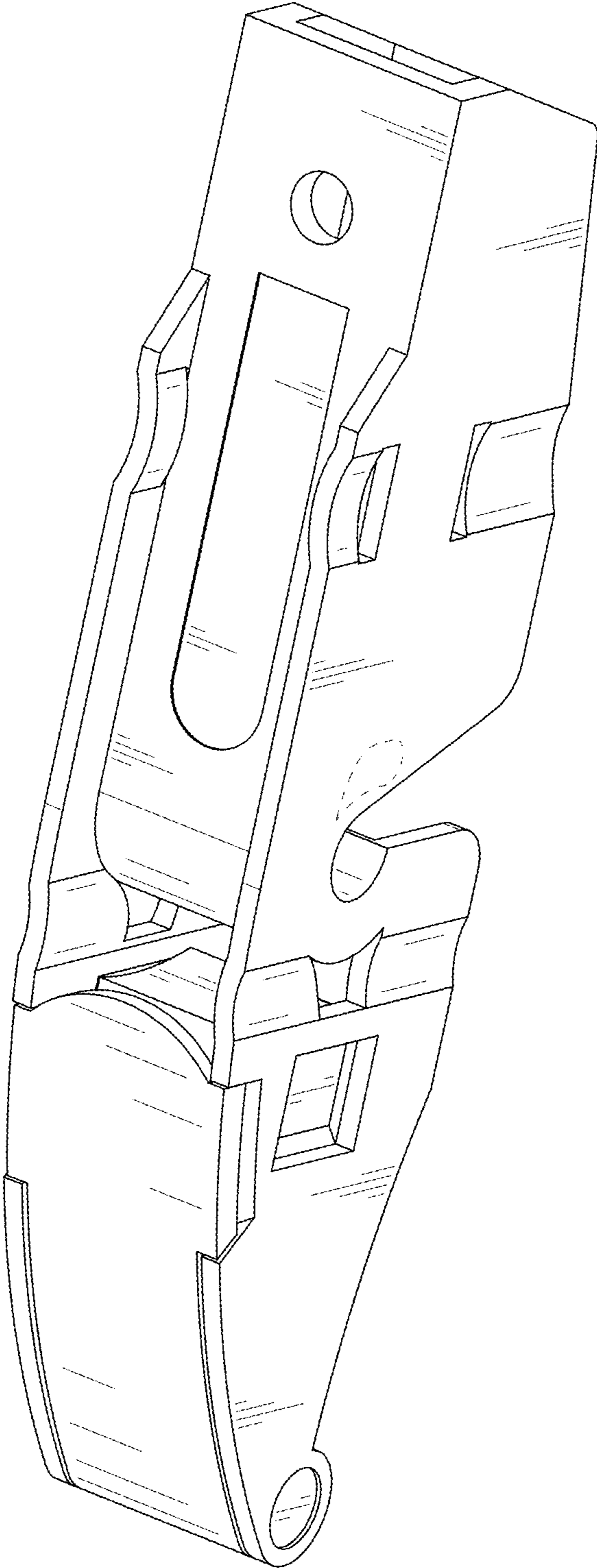

FIG. 1

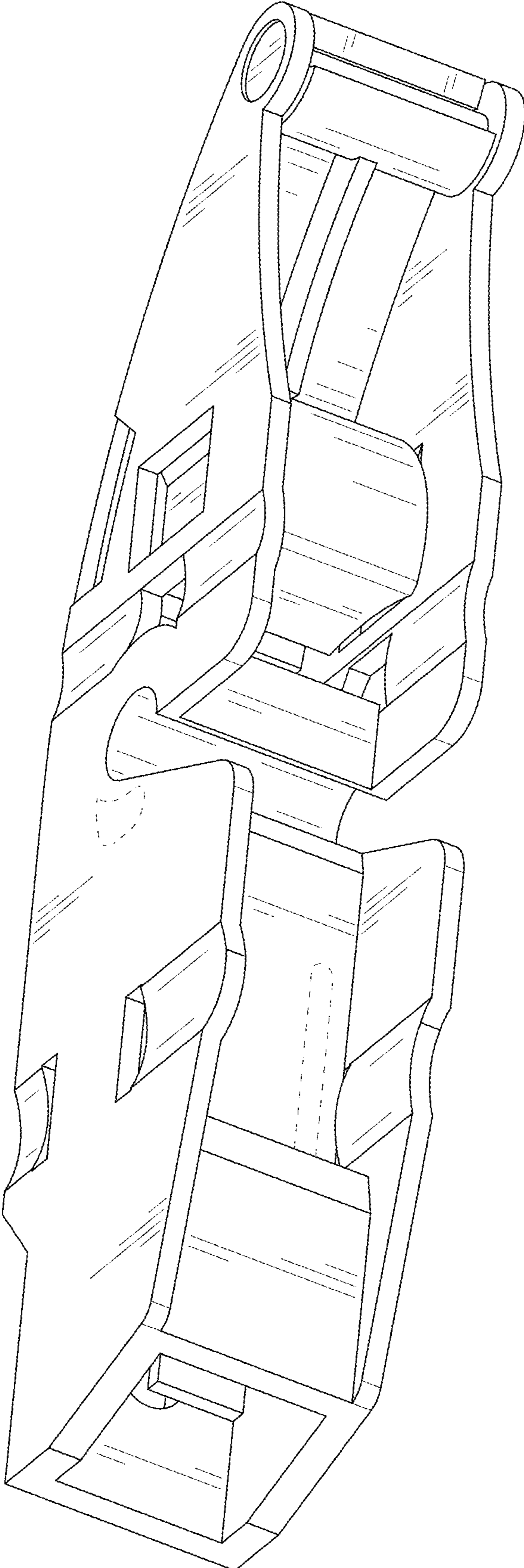

FIG. 2

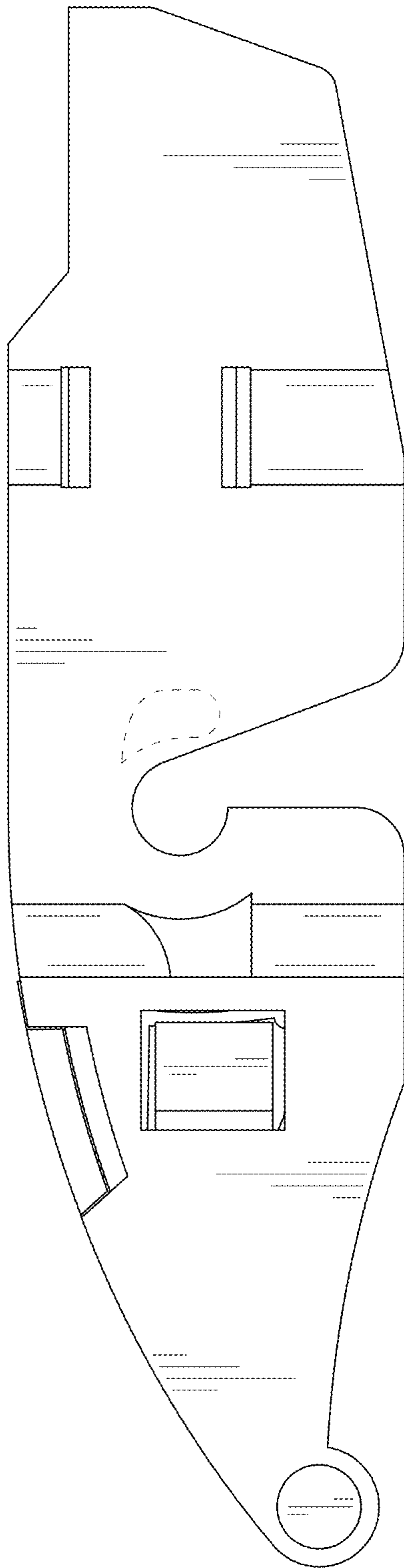

FIG. 3

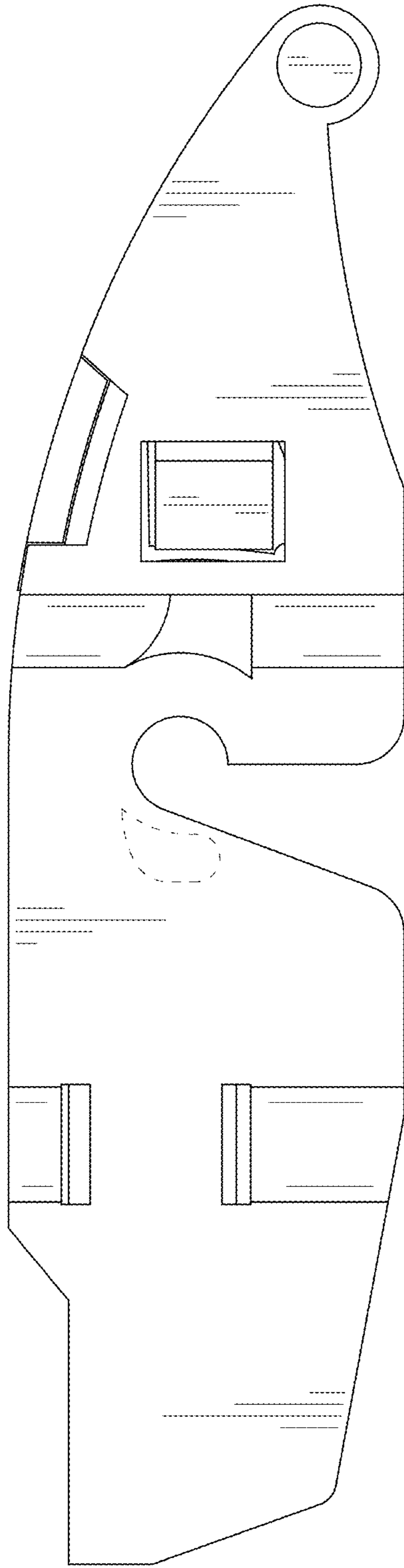

FIG. 4

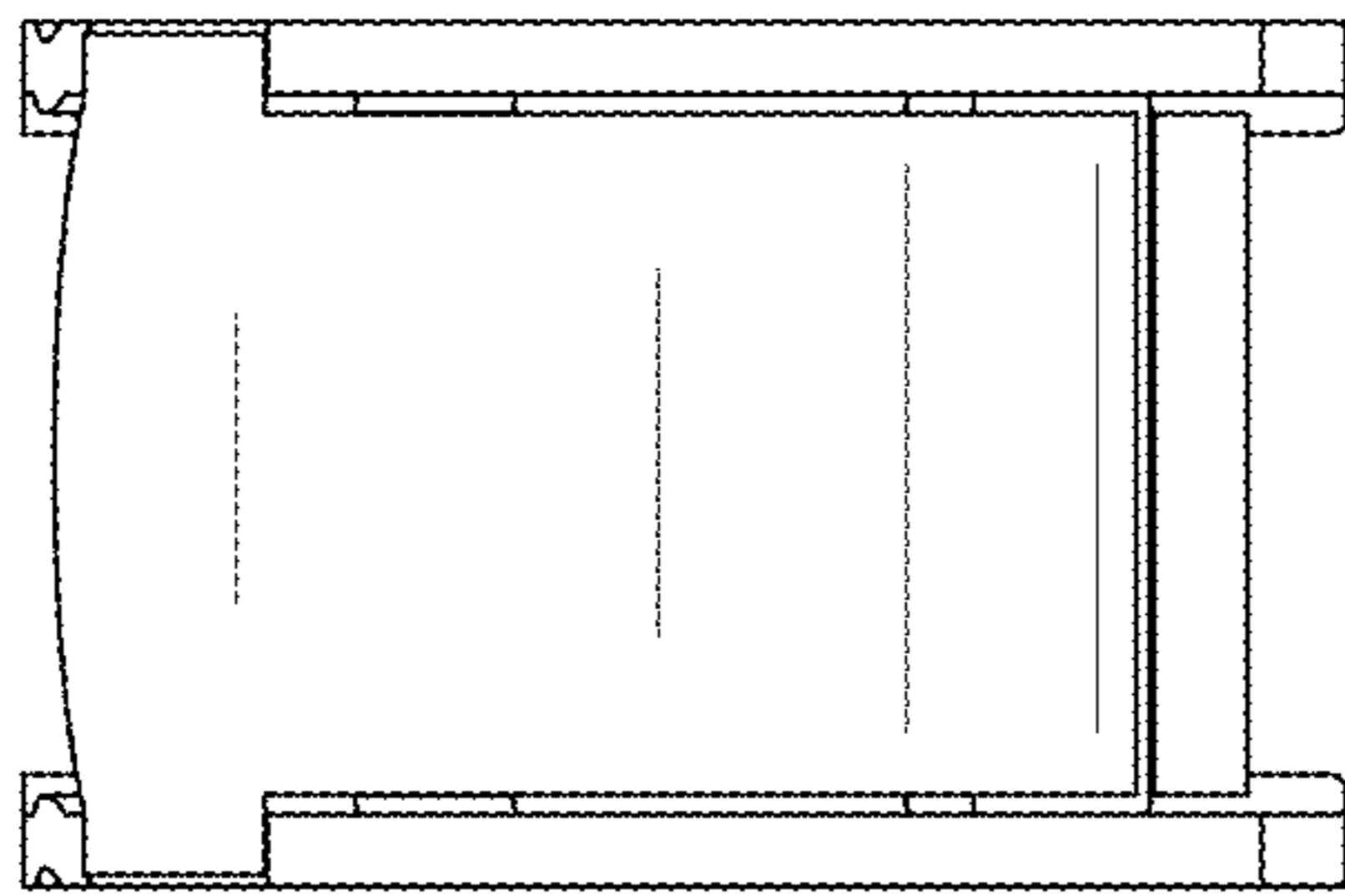

FIG. 5

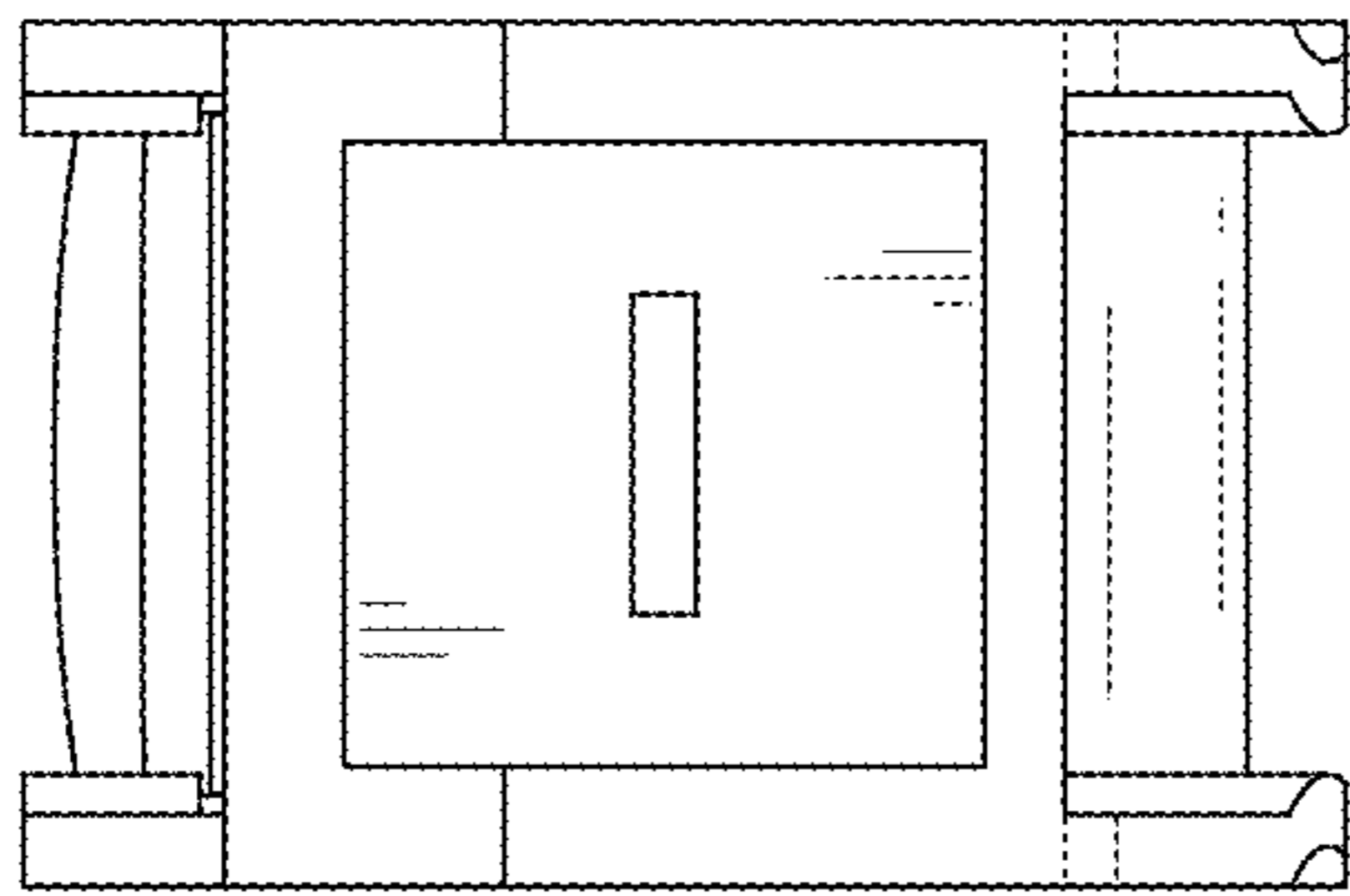

FIG. 6

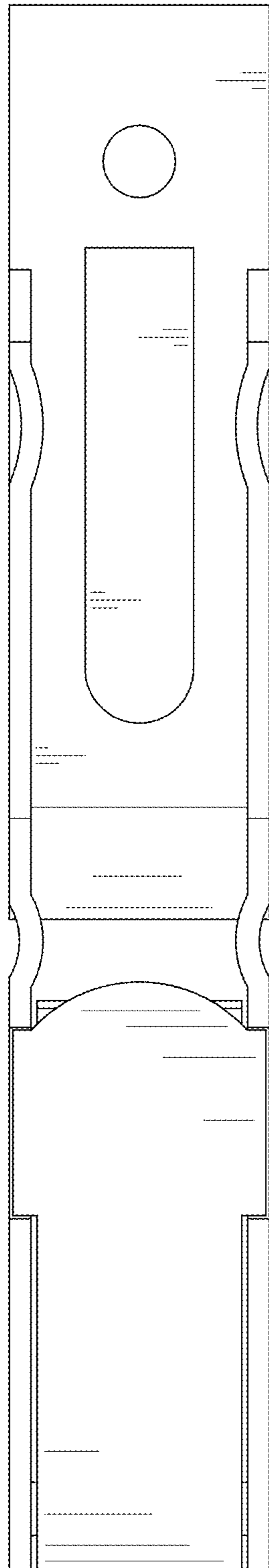

FIG. 7



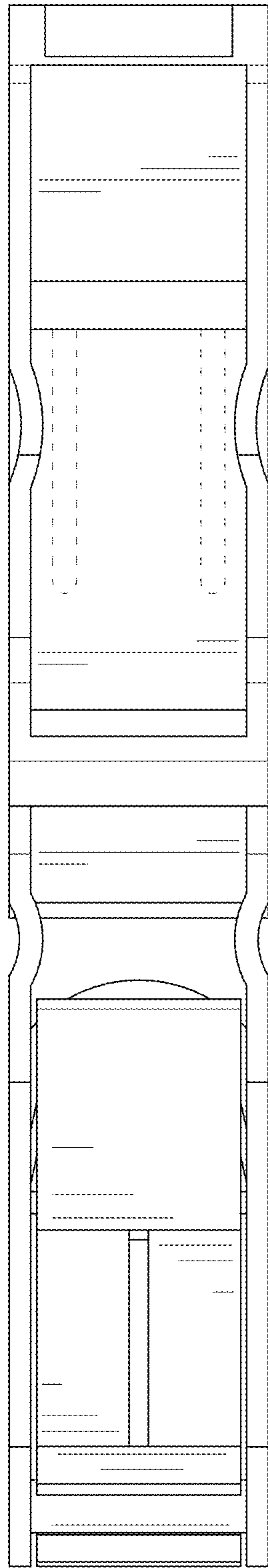

FIG. 8

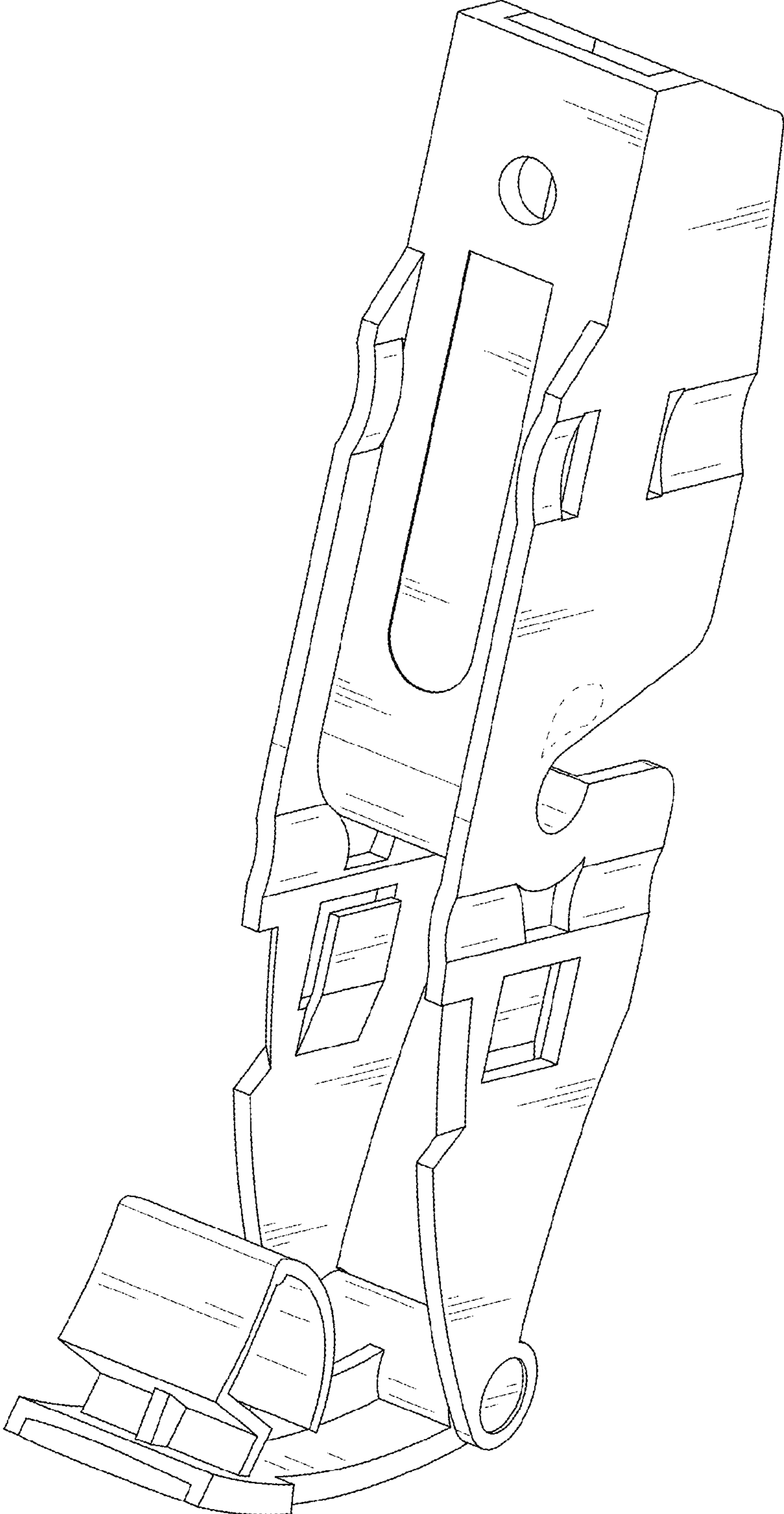

FIG. 9