



US00D981187S

(12) **United States Design Patent** (10) **Patent No.:** **US D981,187 S**
Storer (45) **Date of Patent:** **** Mar. 21, 2023**

(54) **TWIST-UP SNACK DISPENSER**
(71) Applicant: **Kyle R. Storer**, St. Clairsville, OH (US)
(72) Inventor: **Kyle R. Storer**, St. Clairsville, OH (US)
(**) Term: **15 Years**
(21) Appl. No.: **29/746,601**
(22) Filed: **Aug. 14, 2020**
(51) **LOC (14) Cl.** **09-07**
(52) **U.S. Cl.**
USPC **D7/630; D9/729**
(58) **Field of Classification Search**
USPC D7/552.2, 596, 598, 602, 610, 612, D7/629-630, 701, 707, 628, 655, D7/674-675, 605, 608; D9/424-425, D9/428-429, 519, 523-525, 529, D9/544-545, 549, 574, 764, 766, 905,
(Continued)

(56) **References Cited**
U.S. PATENT DOCUMENTS
2,383,726 A * 8/1945 Leshin A45D 40/04 401/75
2,816,654 A * 12/1957 Fuller A45D 40/04 401/75
(Continued)

FOREIGN PATENT DOCUMENTS
JP D1214741 * 8/2004
JP D1335163 * 6/2008

OTHER PUBLICATIONS

Lip Balm Dispenser, brand unlisted, abundanthealth4u.com, author unlisted, published Aug. 15, 2020 per wayback machine © 2020

AbundantHealth4u.com, online, site visited Jul. 28, 2021. Available at URL: <https://www.abundanthealth4u.com/lip-balm-dispensers.html> (Year: 2020).*

(Continued)

Primary Examiner — Holly E Thurman
Assistant Examiner — Altaira J Swangin
(74) *Attorney, Agent, or Firm* — Porter Wright Morris & Arthur LLP

(57) **CLAIM**
The ornamental design for a twist-up snack dispenser, as shown and described.

DESCRIPTION

FIG. 1 is a front-top perspective view of a twist-up snack dispenser in a closed configuration according to my new design;
FIG. 2 is a front view thereof;
FIG. 3 is a rear view thereof;
FIG. 4 is a right-side view thereof;
FIG. 5 is a left-side view thereof;
FIG. 6 is a top view thereof;
FIG. 7 is a bottom view thereof;
FIG. 8 is a front-top perspective view of the twist-up snack dispenser of FIGS. 1 to 7, shown in an exploded configuration according to my new design;
FIG. 9 is a front-top perspective view of the twist-up snack dispenser of FIGS. 1 to 8, shown in an open configuration according to my new design;
FIG. 10 is a front view thereof;
FIG. 11 is a rear view thereof;
FIG. 12 is a right-side view thereof;
FIG. 13 is a left-side view thereof;
FIG. 14 is a top view thereof; and,
FIG. 15 is a bottom view thereof.
The broken lines in the drawing depict portions of the twist-up snack dispenser that form no portion of the claimed design.

1 Claim, 15 Drawing Sheets

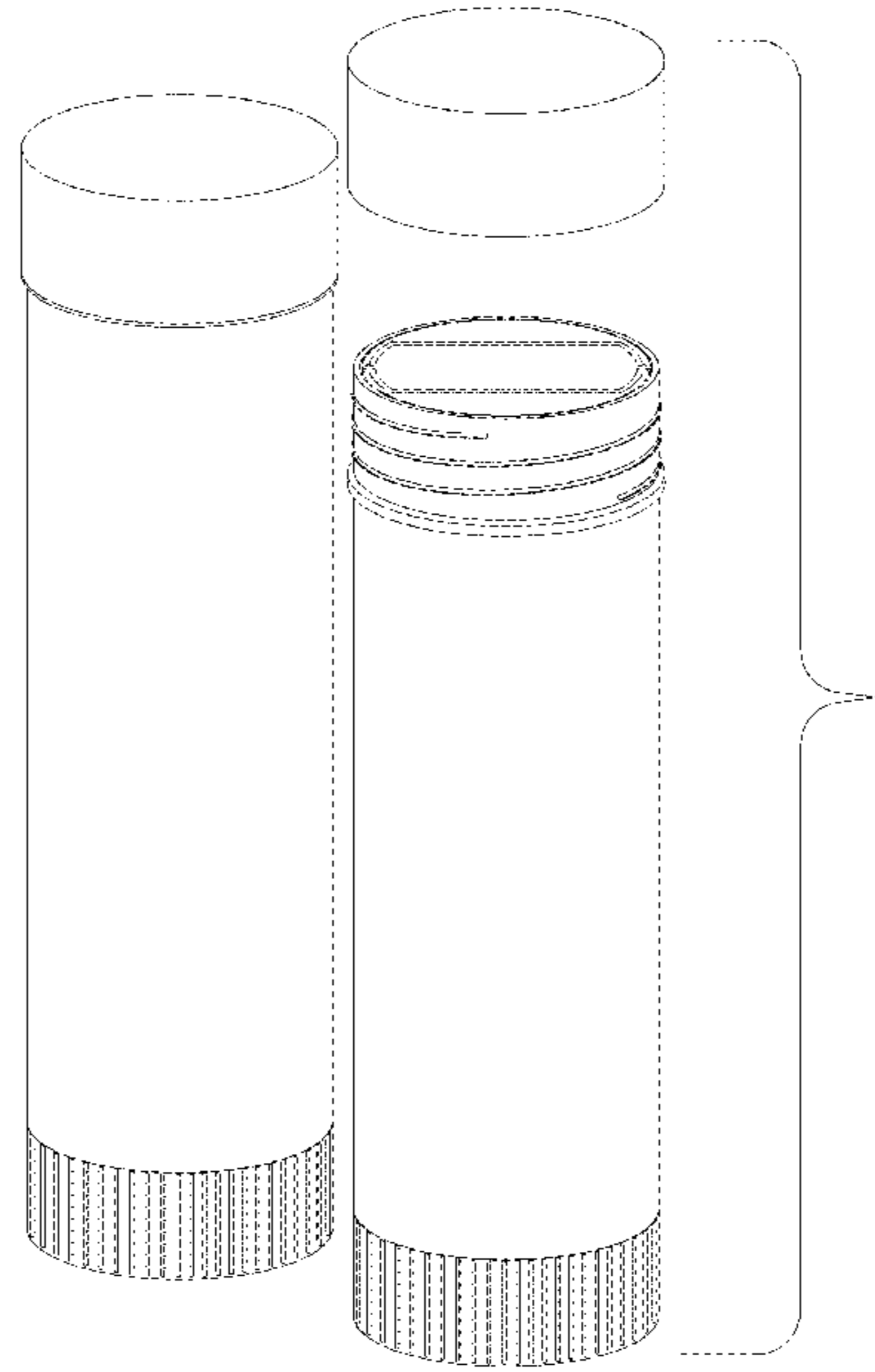

US D981,187 S

Page 2

(58) **Field of Classification Search**

USPC D9/503, 718, 724, 729; D11/184;
D6/534, 677.1; D8/18, 26, 33-34
CPC A47G 19/26; A47G 19/265; A47G
2400/061; A47G 2023/0691; B65D
83/0011; B65D 83/00

See application file for complete search history.

(56) **References Cited**

U.S. PATENT DOCUMENTS

2,935,191 A * 5/1960 Leshin A45D 40/04
401/75
3,620,632 A * 11/1971 Gruska A45D 40/06
401/78
3,850,183 A * 11/1974 Gruska A45D 40/06
401/78
D375,256 S * 11/1996 Chadfield D28/7
D375,870 S * 11/1996 Stonehouse D7/630
6,241,408 B1 * 6/2001 Lang A45D 40/24
132/297
6,623,197 B1 * 9/2003 Lee C09D 13/00
401/175
D530,993 S * 10/2006 Kolflat D7/679
D534,082 S * 12/2006 Chadfield D9/729
D570,688 S * 6/2008 Haywood D9/502
D726,553 S * 4/2015 Koptis D9/724
9,181,005 B2 * 11/2015 DeMarco B65D 47/265
9,474,349 B2 * 10/2016 Holloway A45D 40/06
9,585,460 B2 * 3/2017 Wade A45D 40/12
9,877,566 B2 * 1/2018 Liard A45D 40/06

D835,520 S * 12/2018 Peeters D9/729
10,196,196 B2 * 2/2019 Philipp B65D 83/0011
D888,509 S * 6/2020 Rane D7/630
D927,980 S * 8/2021 Jiang D9/504
11,485,567 B2 * 11/2022 Lin B65D 83/02
2007/0059088 A1 * 3/2007 Chan A45D 40/06
401/75
2008/0101850 A1 * 5/2008 Wojcik A45D 34/04
401/265
2013/0294810 A1 * 11/2013 Chan A45D 40/06
401/75
2014/0151408 A1 * 6/2014 DeMarco B65D 51/18
222/488
2015/0003885 A1 * 1/2015 Wade A45D 40/12
401/75
2015/0164202 A1 * 6/2015 Zhu A45D 40/06
401/75
2016/0075499 A1 * 3/2016 Philipp B65D 83/0011
222/319
2020/0362210 A1 * 11/2020 Sakato C09J 9/005
2022/0063878 A1 * 3/2022 Anderson B65D 41/02

OTHER PUBLICATIONS

.50 oz. Round Natural Twist-up Tube, Elements Bath and Body,
elementsbathandbody.com, author unlisted, published Mar. 6, 2021
per wayback machine © 2021 Elements Bath and Body, online, site
visited Aug. 21, 2021. URL: <https://www.elementsbathandbody.com/products/.50-oz-round-natural-twist-up.aspx> (Year: 2021).*

* cited by examiner

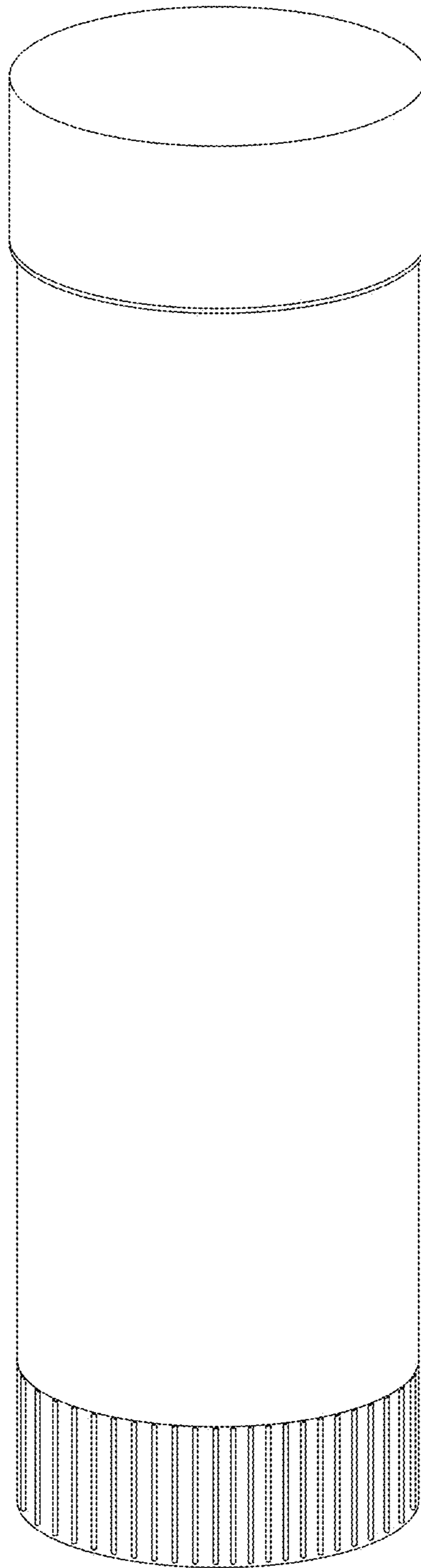

FIG. 1

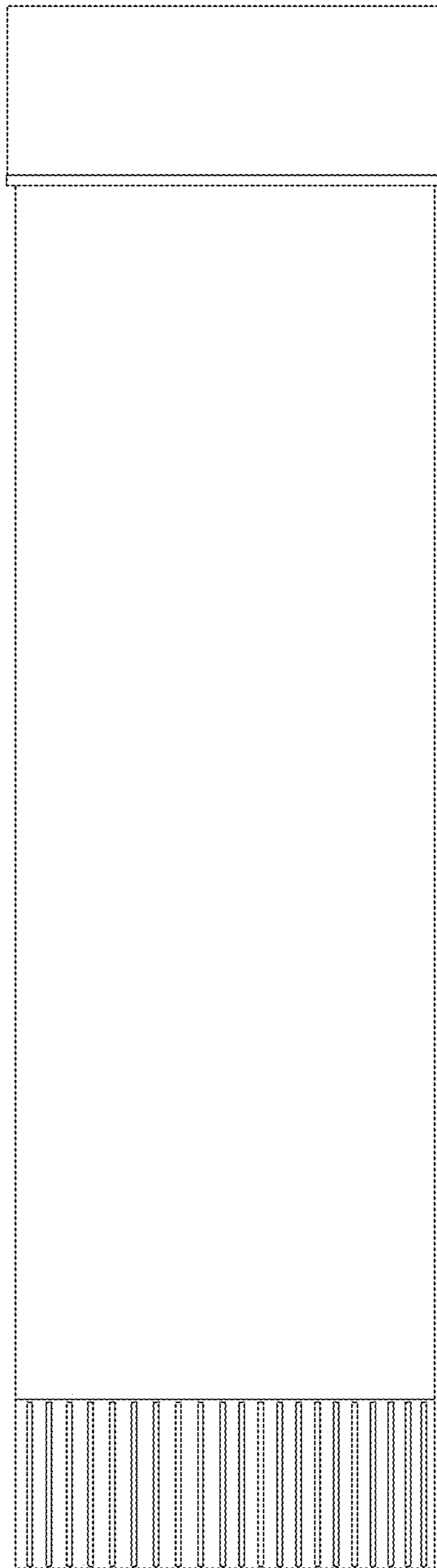

FIG. 2

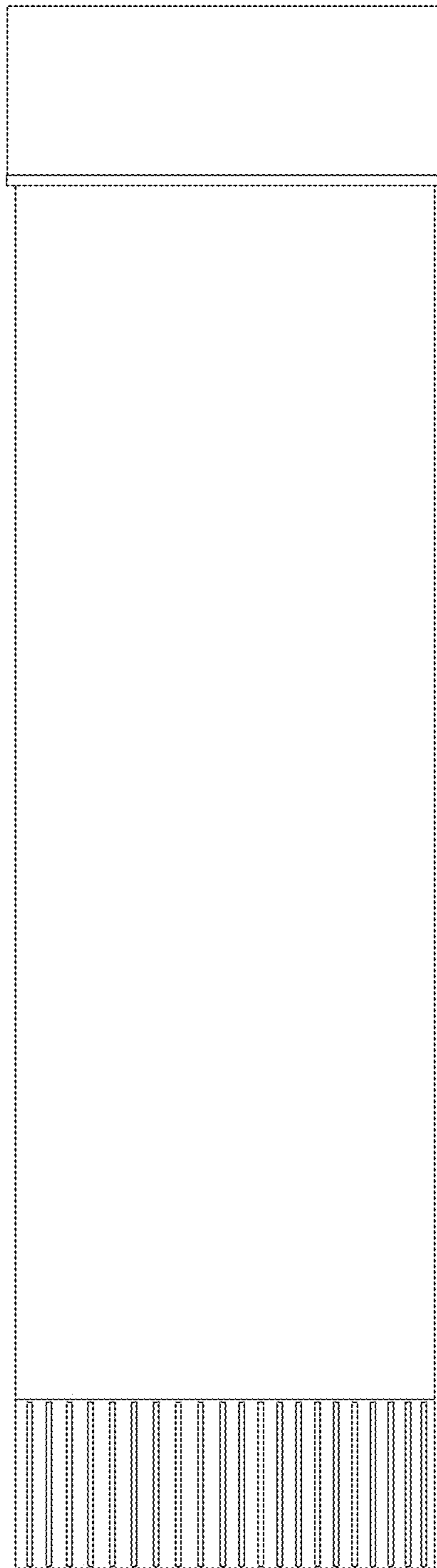

FIG. 3

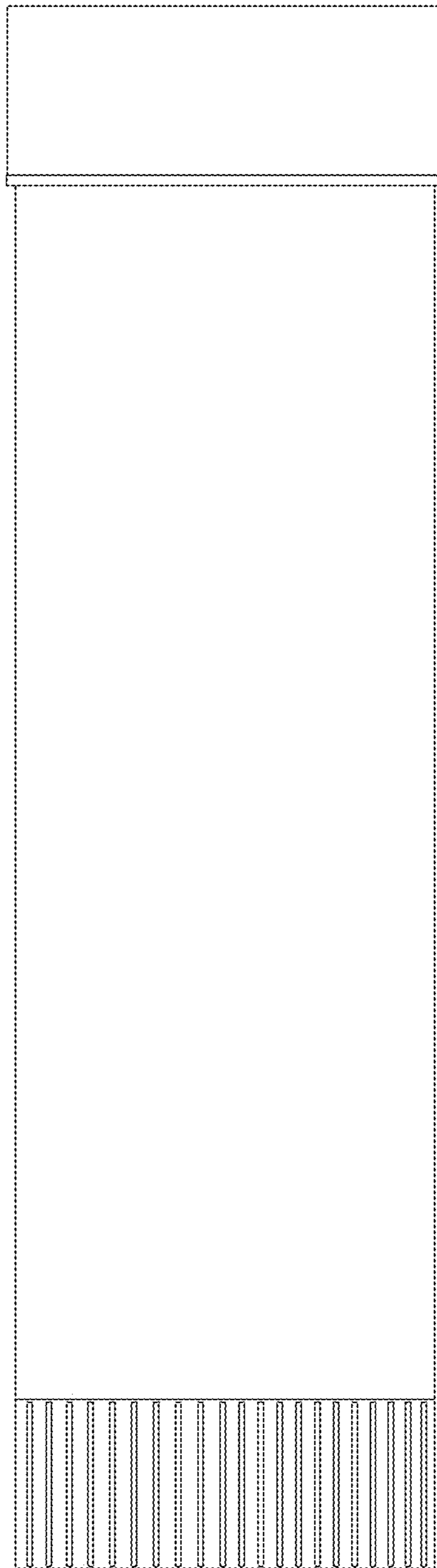

FIG. 4

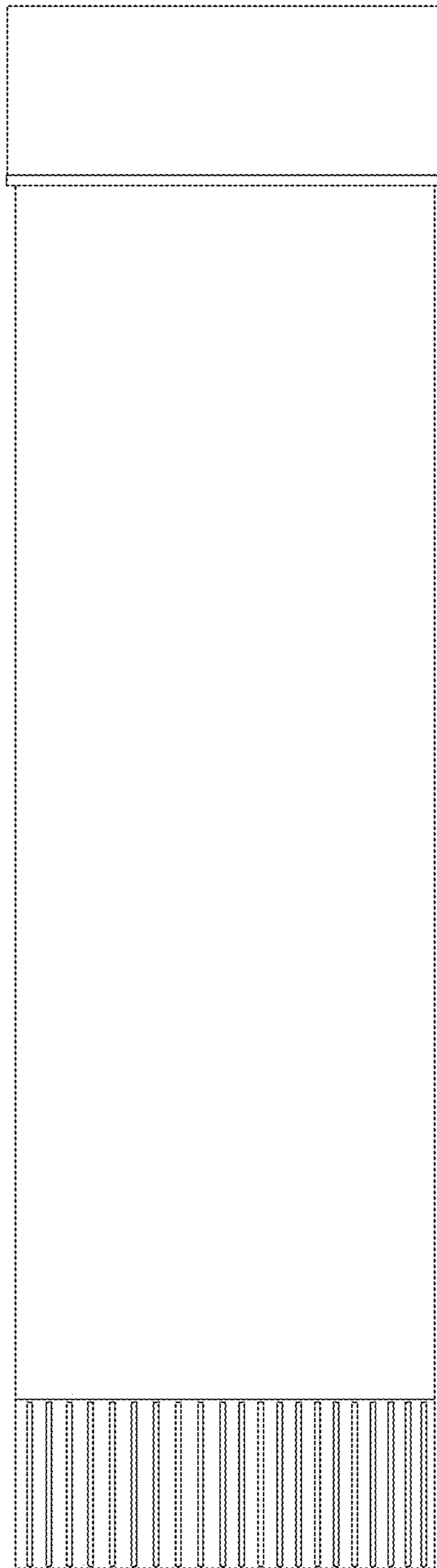

FIG. 5

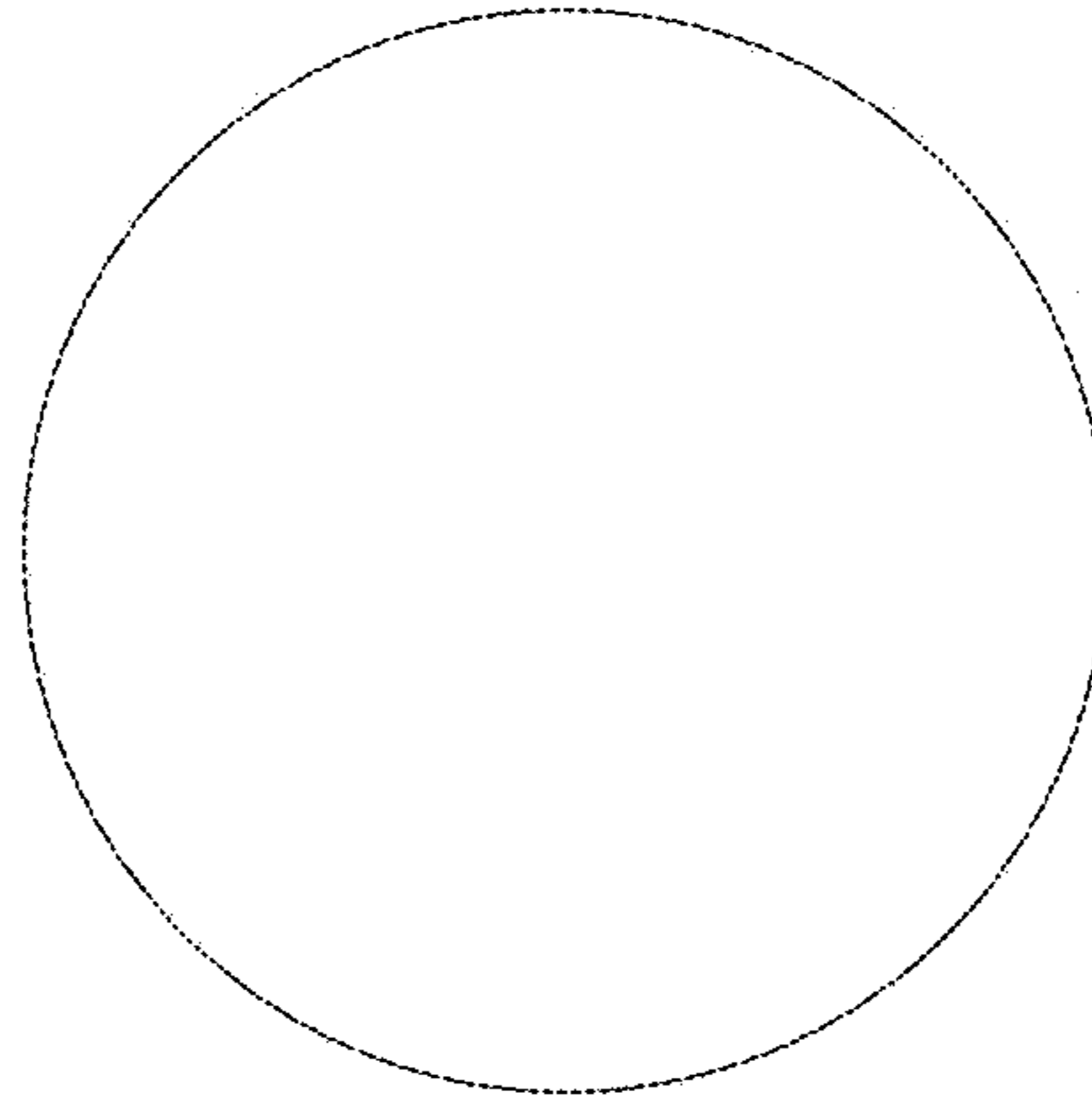

FIG. 6

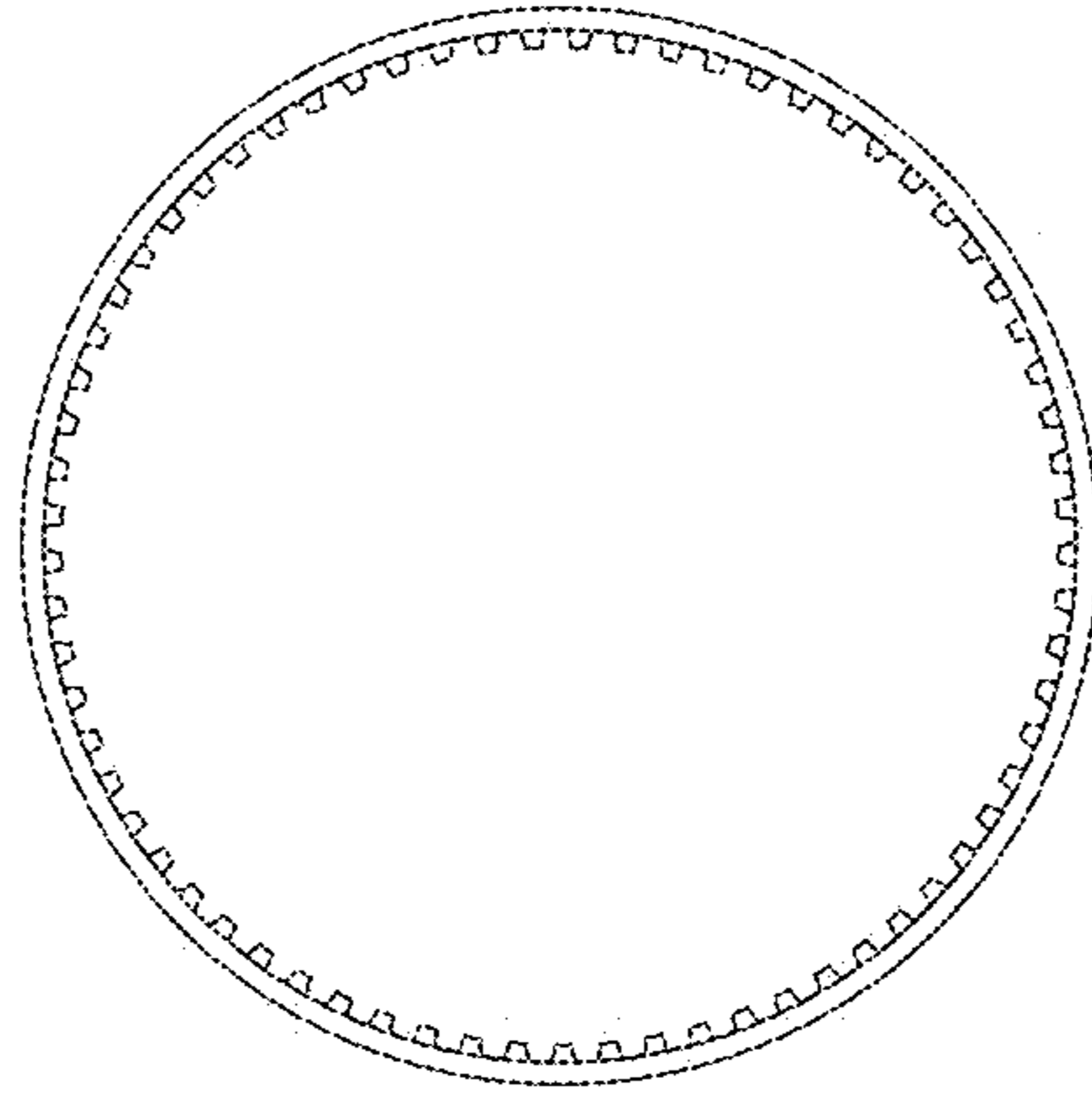

FIG. 7

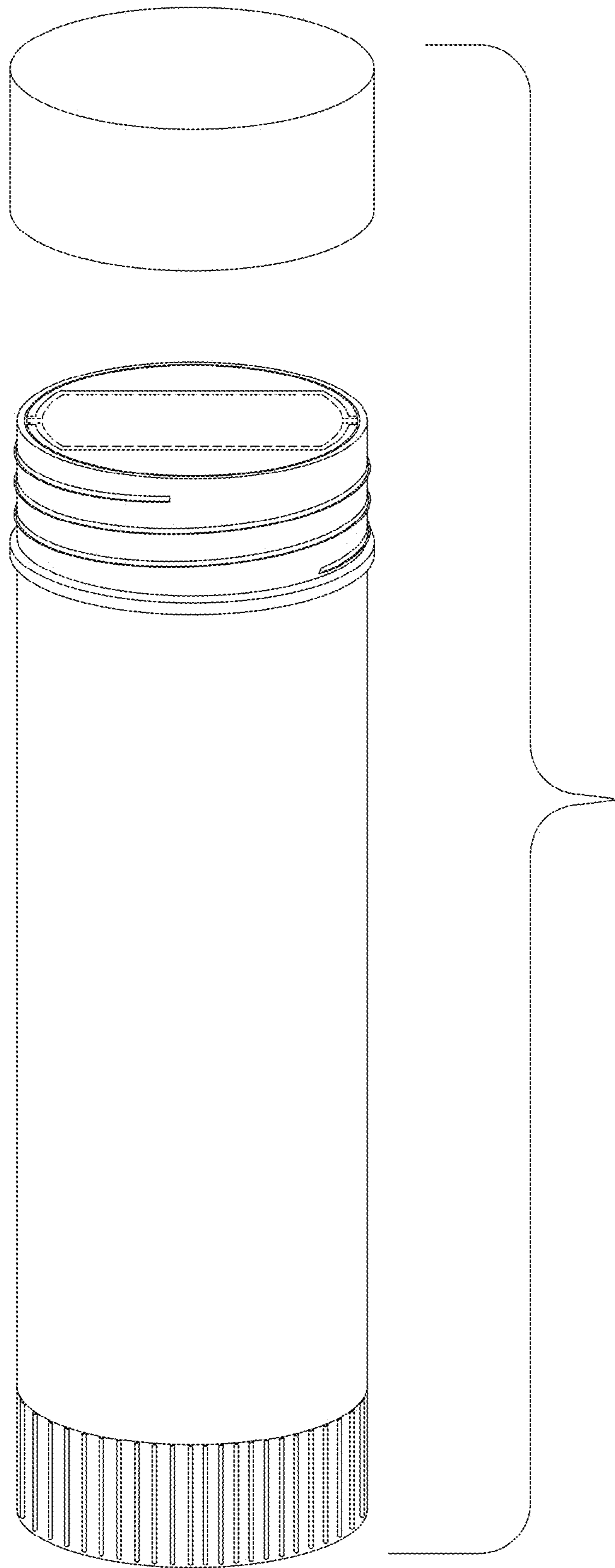

FIG. 8

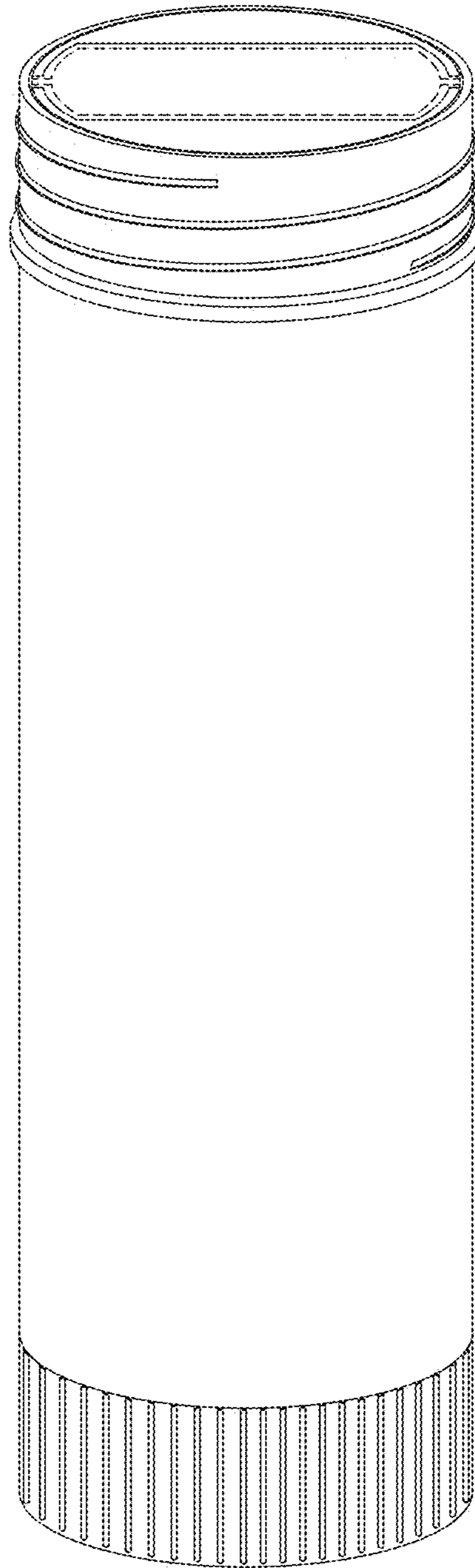

FIG. 9

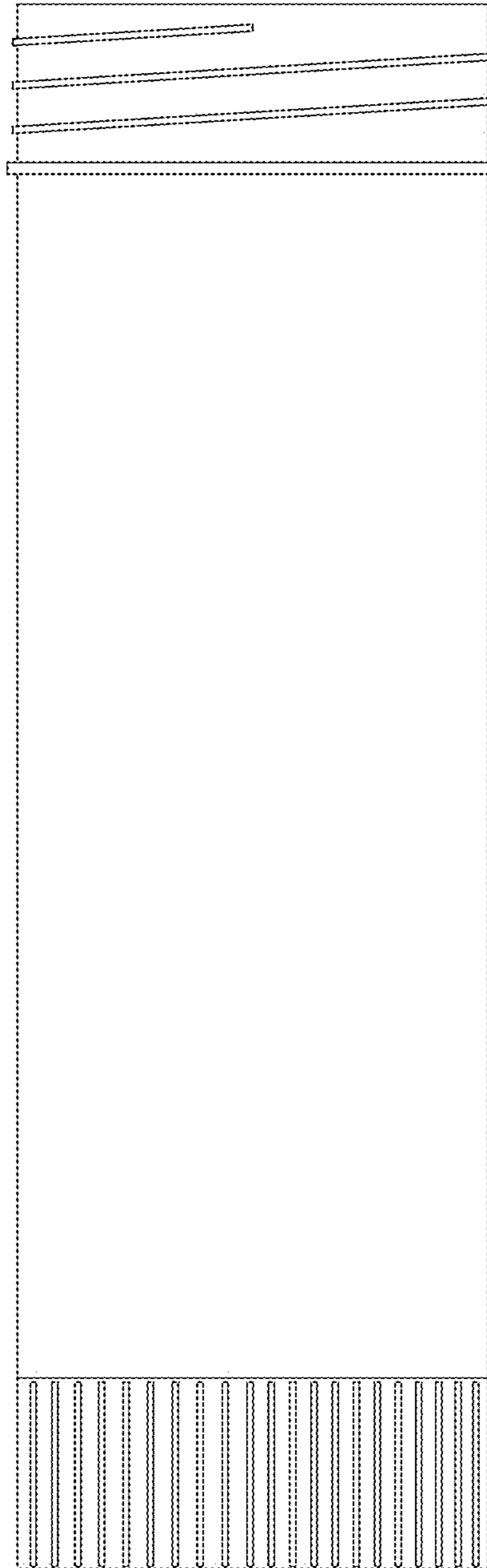

FIG. 10

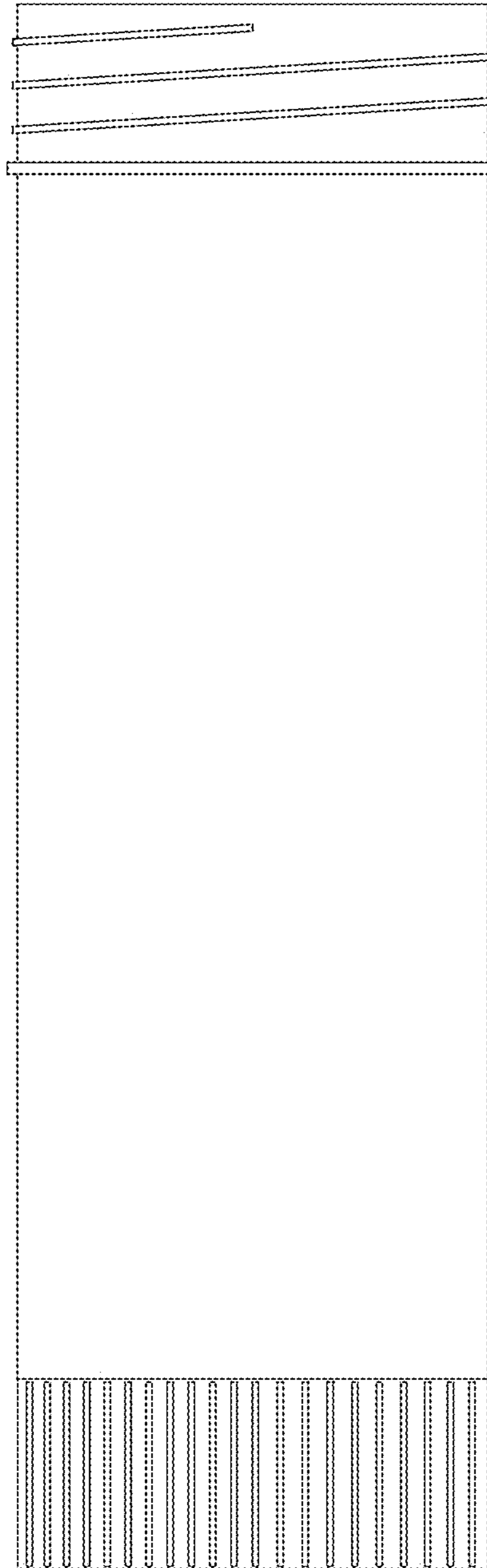

FIG. 11

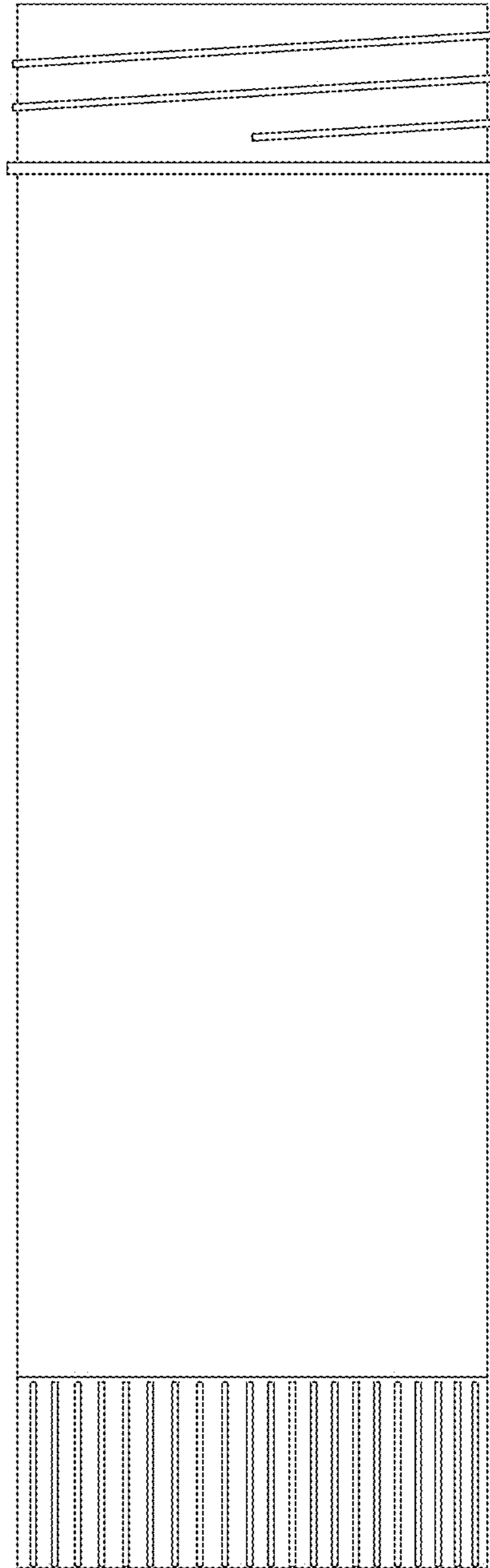

FIG. 12

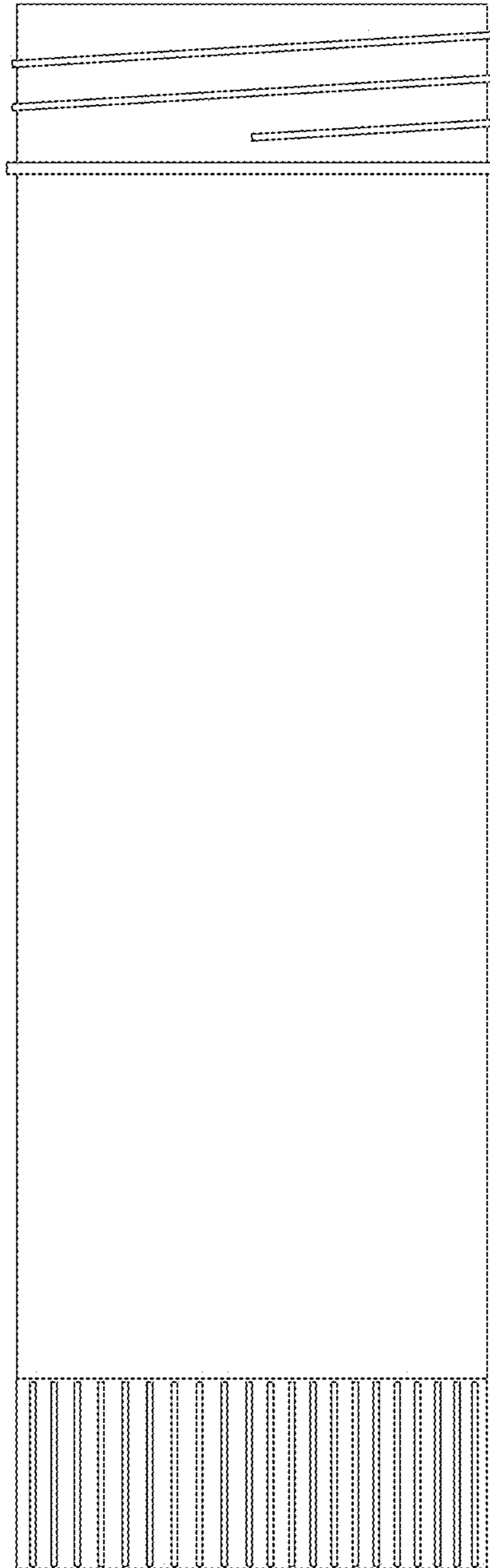

FIG. 13

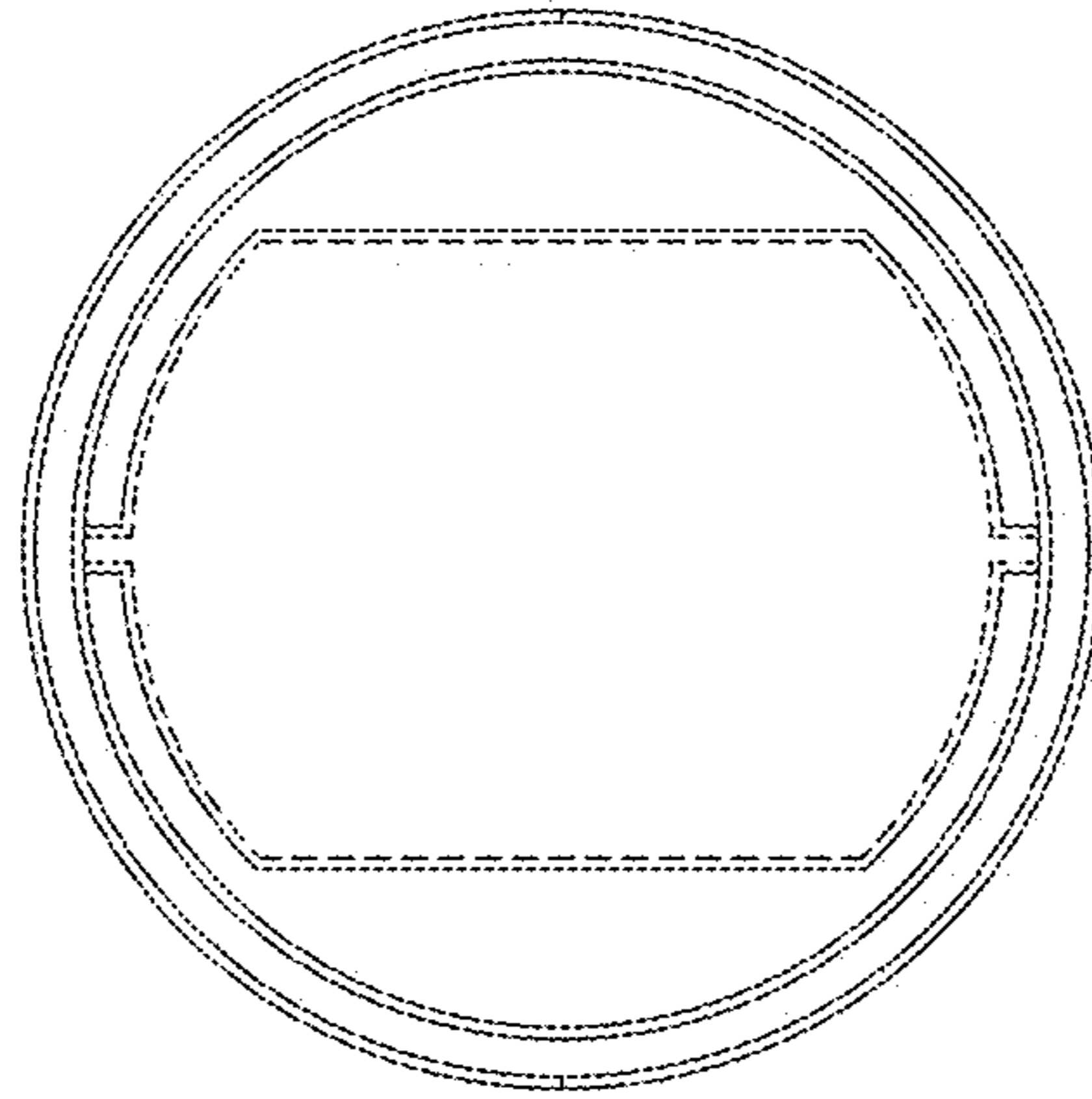

FIG. 14

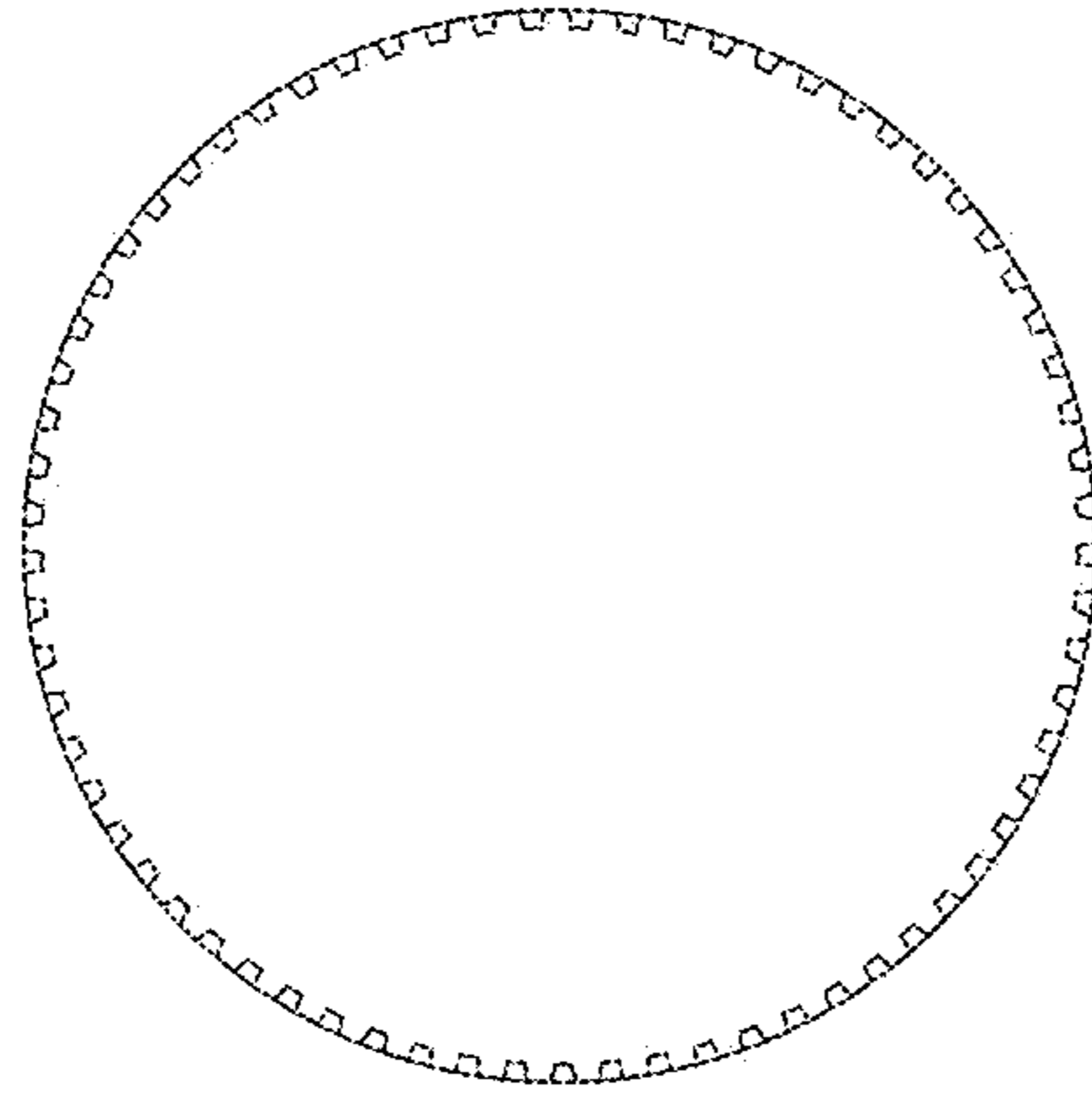

FIG. 15