



US00D981184S

(12) **United States Design Patent**
LaMance

(10) **Patent No.:** **US D981,184 S**
(45) **Date of Patent:** **** Mar. 21, 2023**

- (54) **INSULATED BEVERAGE CONTAINER**
- (71) Applicant: **Kanga, LLC.**, Greenville, SC (US)
- (72) Inventor: **Logan T. LaMance**, Greenville, SC (US)
- (73) Assignee: **Kanga, LLC**, Greenville, SC (US)
- (**) Term: **15 Years**
- (21) Appl. No.: **29/762,423**
- (22) Filed: **Dec. 16, 2020**
- (51) **LOC (14) Cl.** **07-99**
- (52) **U.S. Cl.**
USPC **D7/607**
- (58) **Field of Classification Search**
USPC D7/300, 300.1, 312, 313, 354, 355, 360, D7/361, 387, 391, 392, 396.2, 509, 510, D7/511, 512, 513, 523, 533, 536, D7/601-608, 619.1, 622, 624.1-624.3, D7/625, 629, 630, 709; D3/202, D3/215-217, 272-274, 276, 279, 283, D3/284, 294, 295, 299, 301, 318, 327; D15/81, 83
CPC A45C 11/20; A45C 13/02; A47J 27/002; A47J 27/004; A47J 36/10; A47J 36/24; A47J 36/2483; A47J 36/32; A47J 47/10; B29C 66/53461; B65D 43/02; B65D 43/162; B65D 2543/00092; B65D 81/3386; B65D 81/38; B65D 81/3802; B65D 81/3823; B65D 81/3837; B65D 81/3839; B65D 81/3841; B65D 81/3844; B65D 81/3846; B65D 81/3876; B67D 1/0857; B67D 3/0009; F25D 3/02; F25D 3/0812; F25D 3/14; F25D 31/002; F25D 31/007; F25D 31/008; F25D 2331/801; F25D 2331/803; F25D 2331/804; F25D

(Continued)

- (56) **References Cited**
U.S. PATENT DOCUMENTS
D340,351 S * 10/1993 Wrath D3/217
D412,269 S * 7/1999 Wyant A45C 13/02
D7/607

(Continued)

- OTHER PUBLICATIONS**
Kanga Insulated Cooler Bag, first available Jan. 11, 2022, Amazon, [online]. [site visited Apr. 15, 2022], Available from internet URL: <https://www.amazon.com/Kanga-Insulated-Cooler-Bag-Durability/dp/B09Q5GHVNG> (Year: 2022).*

Primary Examiner — Mary Ann Calabrese
Assistant Examiner — Natalya M Rapundalo
(74) *Attorney, Agent, or Firm* — Nelson Mullins Riley & Scarborough LLP

(57) **CLAIM**
The ornamental design for an insulated beverage container, as shown and described.

DESCRIPTION

FIG. 1 is a perspective view of the insulated beverage container;
FIG. 2 is a front side view of the insulated beverage container;
FIG. 3 is a rear side view of the insulated beverage container;
FIG. 4 is a left side view of the insulated beverage container;
FIG. 5 is a right side view of the insulated beverage container;
FIG. 6 is a top view of the insulated beverage container; and,
FIG. 7 is a bottom view of the insulated beverage container.
The broken lines are for showing stitching, zipper tabs and logo placement of the insulated beverage container and form no part of the claimed design.

1 Claim, 6 Drawing Sheets

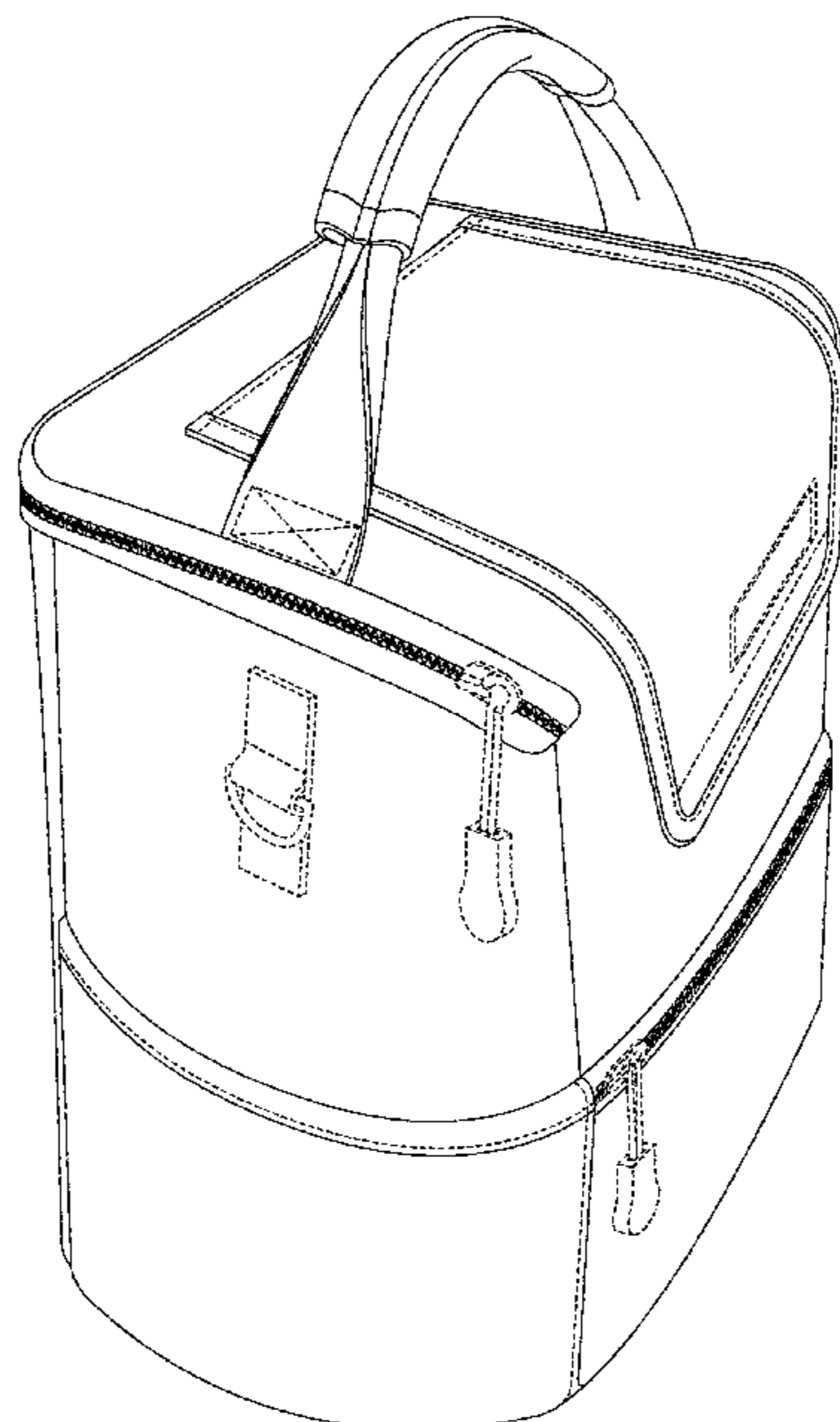

(58) **Field of Classification Search**
 CPC 2331/8041; F25D 2331/805; F25D
 2331/806; F25D 2331/809; F25D 2400/16
 See application file for complete search history.

(56) **References Cited**

U.S. PATENT DOCUMENTS

D465,086 S * 11/2002 Watts A45C 13/02
 D3/276
 D471,361 S * 3/2003 Crandall D3/301
 D476,154 S * 6/2003 Lovett D3/276
 D732,348 S 6/2015 Seiders et al.
 D732,349 S 6/2015 Seiders et al.
 D732,350 S 6/2015 Seiders et al.
 D732,899 S 6/2015 Seiders et al.
 9,139,352 B2 9/2015 Seiders et al.
 D752,347 S 3/2016 Seiders et al.
 D786,559 S 5/2017 Seiders et al.
 D786,560 S 5/2017 Seiders et al.
 D786,561 S 5/2017 Seiders et al.
 D786,562 S 5/2017 Seiders et al.
 D787,187 S 5/2017 Seiders et al.
 D797,454 S 9/2017 Seiders et al.
 D797,455 S 9/2017 Seiders et al.
 D798,670 S 10/2017 Seiders et al.
 D799,276 S 10/2017 Seiders et al.
 D799,277 S 10/2017 Seiders et al.
 D799,905 S 10/2017 Seiders et al.
 D801,123 S 10/2017 Seiders et al.
 9,796,517 B2 10/2017 Seiders et al.
 D802,373 S 11/2017 Seiders et al.
 D805,851 S 12/2017 Sullivan et al.
 D808,172 S 1/2018 Seiders et al.
 D808,173 S 1/2018 Seiders et al.
 D808,174 S 1/2018 Seiders et al.
 D808,175 S 1/2018 Seiders et al.
 D808,225 S 1/2018 Seiders et al.
 D808,655 S 1/2018 Seiders et al.
 D808,730 S 1/2018 Sullivan et al.
 D809,869 S 2/2018 Seiders et al.
 9,902,548 B2 2/2018 Seiders et al.
 D811,746 S 3/2018 Seiders et al.
 D814,879 S 4/2018 Larson et al.
 D815,496 S 4/2018 Larson et al.
 D817,106 S 5/2018 Larson et al.
 D817,107 S 5/2018 Larson et al.
 D821,825 S 7/2018 Sullivan et al.
 D822,987 S 7/2018 Seiders et al.
 D822,997 S 7/2018 Seiders et al.
 D822,998 S 7/2018 Seiders et al.
 D822,999 S 7/2018 Seiders et al.
 D823,601 S 7/2018 Seiders et al.
 D823,602 S 7/2018 Seiders et al.
 10,029,842 B2 7/2018 Seiders et al.
 D824,731 S 8/2018 Sullivan et al.
 D825,276 S 8/2018 Seiders et al.
 D829,244 S 9/2018 Sullivan et al.
 D830,132 S 10/2018 Sullivan et al.
 D830,133 S 10/2018 Sullivan et al.

D830,134 S 10/2018 Sullivan et al.
 10,143,282 B2 12/2018 Seiders et al.
 D840,687 S 2/2019 Seiders et al.
 D840,689 S 2/2019 Seiders et al.
 D840,761 S 2/2019 Seiders et al.
 D840,762 S 2/2019 Seiders et al.
 D840,763 S 2/2019 Seiders et al.
 D840,764 S 2/2019 Seiders et al.
 D844,975 S 4/2019 Munie et al.
 D844,976 S 4/2019 Munie et al.
 D844,977 S 4/2019 Munie et al.
 D844,978 S 4/2019 Munie et al.
 D844,979 S 4/2019 Munie et al.
 D844,992 S 4/2019 Seiders et al.
 D848,219 S 5/2019 Munie et al.
 D848,220 S 5/2019 Munie et al.
 D848,221 S 5/2019 Munie et al.
 D848,222 S 5/2019 Munie et al.
 D848,223 S 5/2019 Munie et al.
 D848,798 S 5/2019 Munie et al.
 D849,486 S 5/2019 Munie et al.
 D851,400 S 6/2019 Seiders et al.
 D851,404 S 6/2019 Seiders et al.
 D853,115 S 7/2019 Seiders et al.
 D853,728 S 7/2019 Seiders et al.
 D854,312 S 7/2019 Seiders et al.
 D854,322 S 7/2019 Seiders et al.
 10,384,855 B2 8/2019 Seiders et al.
 D859,812 S 9/2019 Seiders et al.
 D859,813 S 9/2019 Seiders et al.
 D859,814 S 9/2019 Seiders et al.
 D859,815 S 9/2019 Seiders et al.
 D859,934 S 9/2019 Seiders et al.
 D860,634 S 9/2019 Seiders et al.
 D861,338 S 10/2019 Seiders et al.
 D862,177 S 10/2019 Seiders et al.
 D862,528 S 10/2019 Sullivan et al.
 10,442,599 B2 10/2019 Seiders et al.
 D866,186 S 11/2019 Seiders et al.
 D871,074 S 12/2019 Seiders et al.
 D871,765 S 1/2020 Seiders et al.
 D877,514 S 3/2020 Seiders et al.
 10,577,167 B2 3/2020 Seiders et al.
 D880,862 S 4/2020 Seiders et al.
 D882,956 S 5/2020 Seiders et al.
 D883,660 S * 5/2020 He D3/217
 D887,699 S 6/2020 Bullock et al.
 10,736,391 B2 8/2020 Seiders et al.
 D911,792 S * 3/2021 Candela A45C 11/20
 D7/709
 D923,424 S * 6/2021 Rong D3/289
 D940,462 S * 1/2022 Koenig D3/319
 D942,728 S * 2/2022 Xu D34/7
 2006/0213736 A1 * 9/2006 Godshaw A45C 13/02
 190/110
 2009/0294237 A1 * 12/2009 Sisitsky A45C 11/20
 190/110
 2011/0182532 A1 * 7/2011 Baltus A45C 13/02
 383/109
 2020/0121048 A1 * 4/2020 Royce A45C 13/02

* cited by examiner

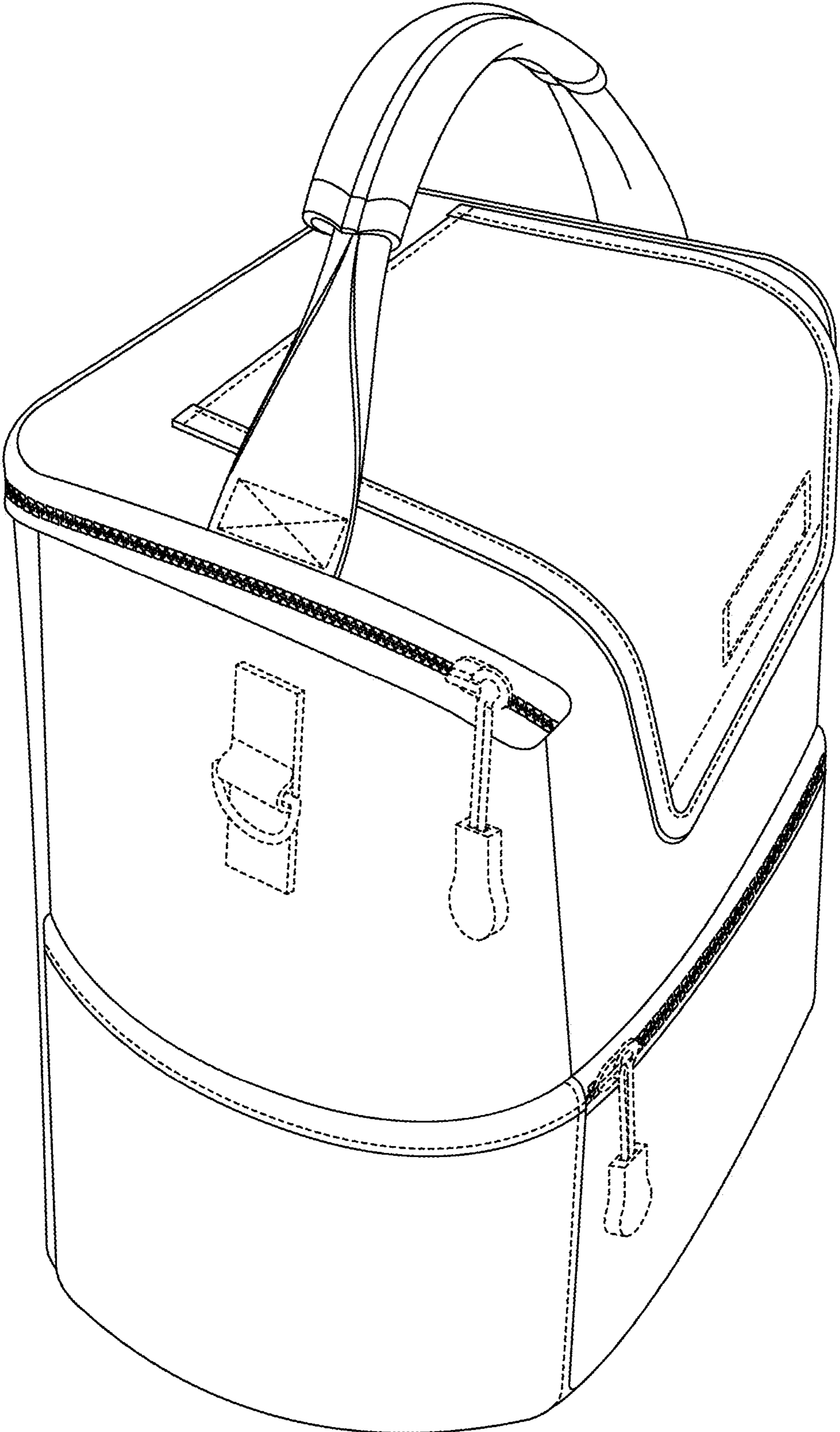

FIG. 1



FIG. 2

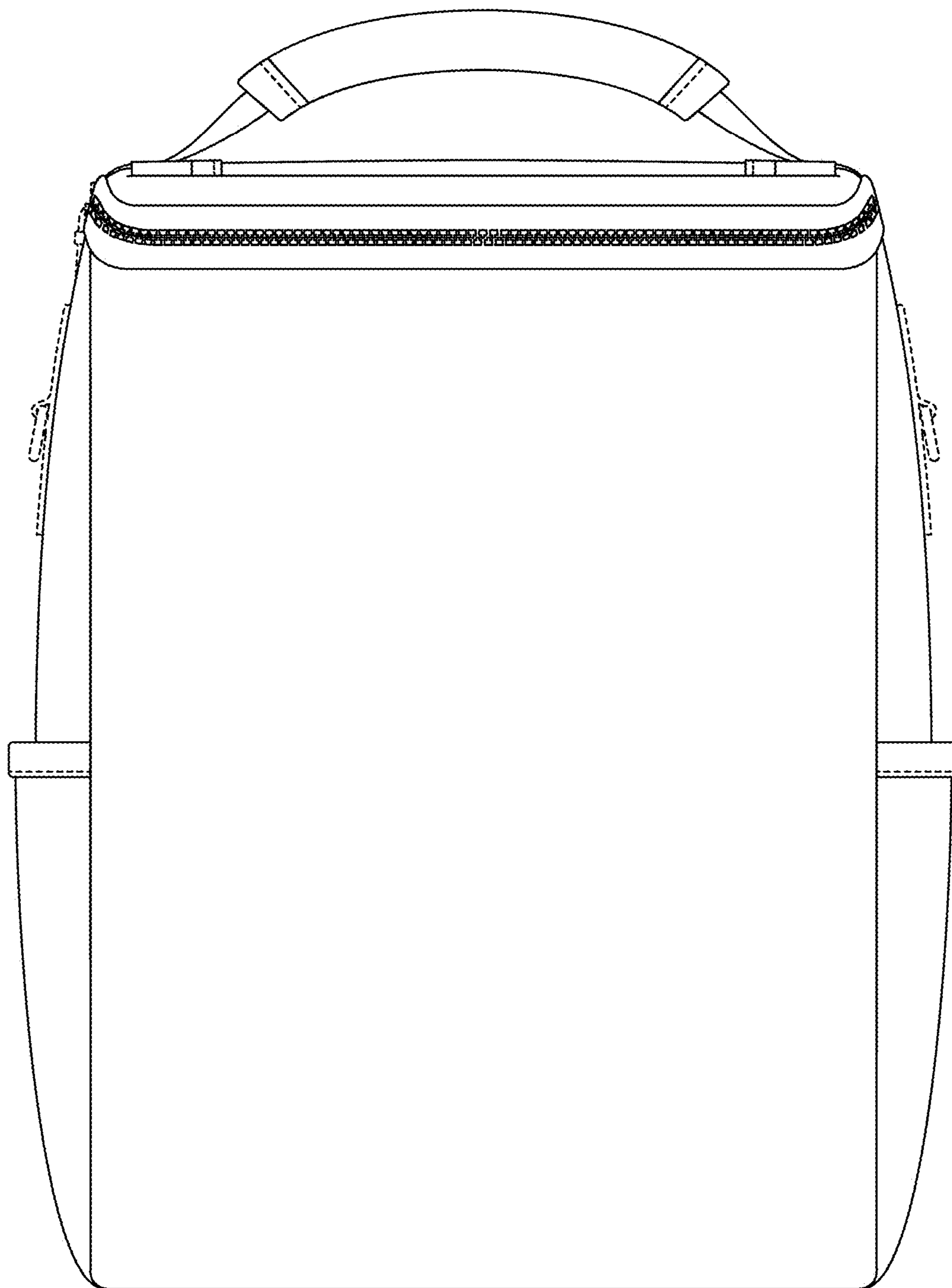

FIG. 3

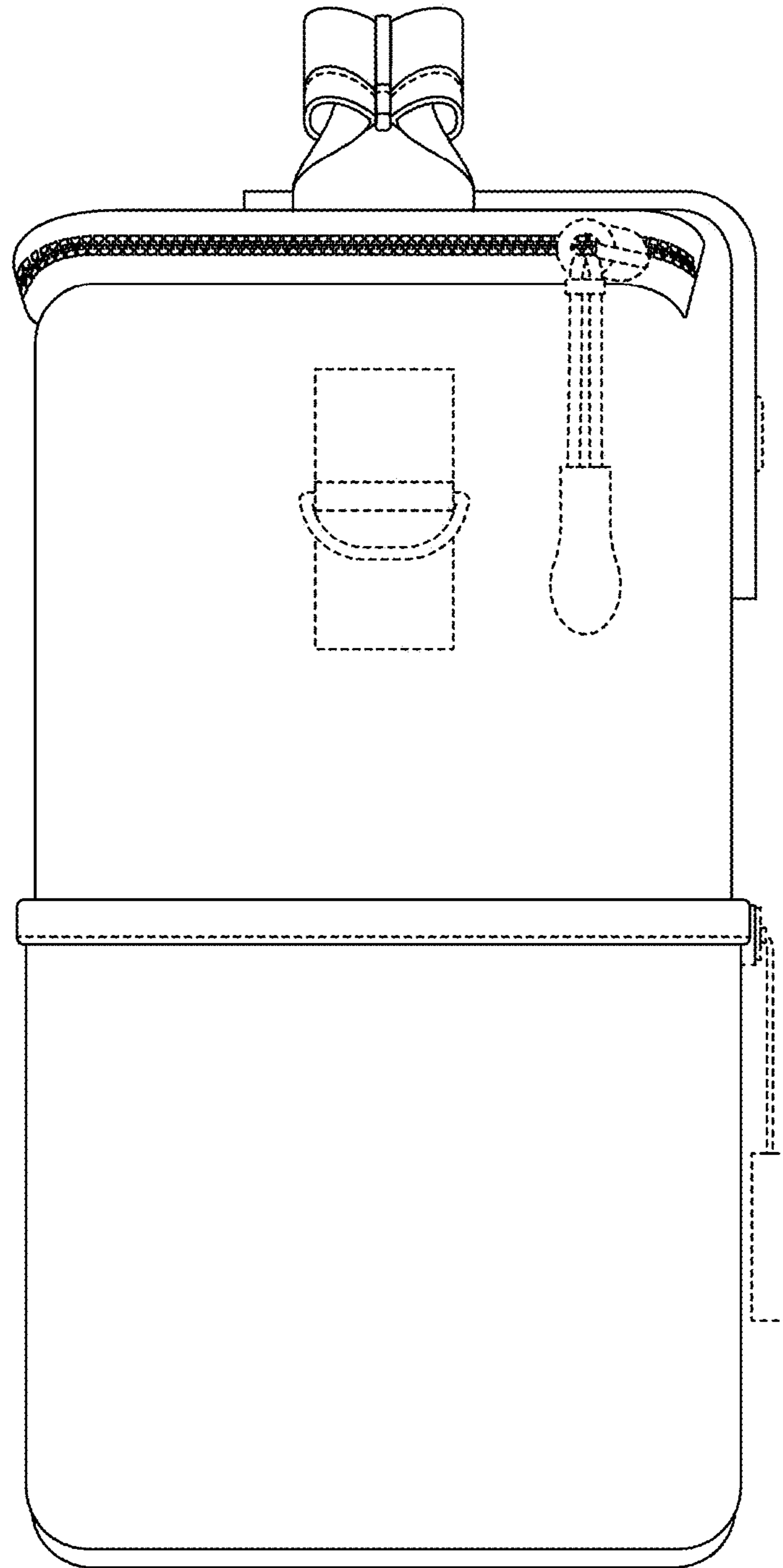

FIG. 4

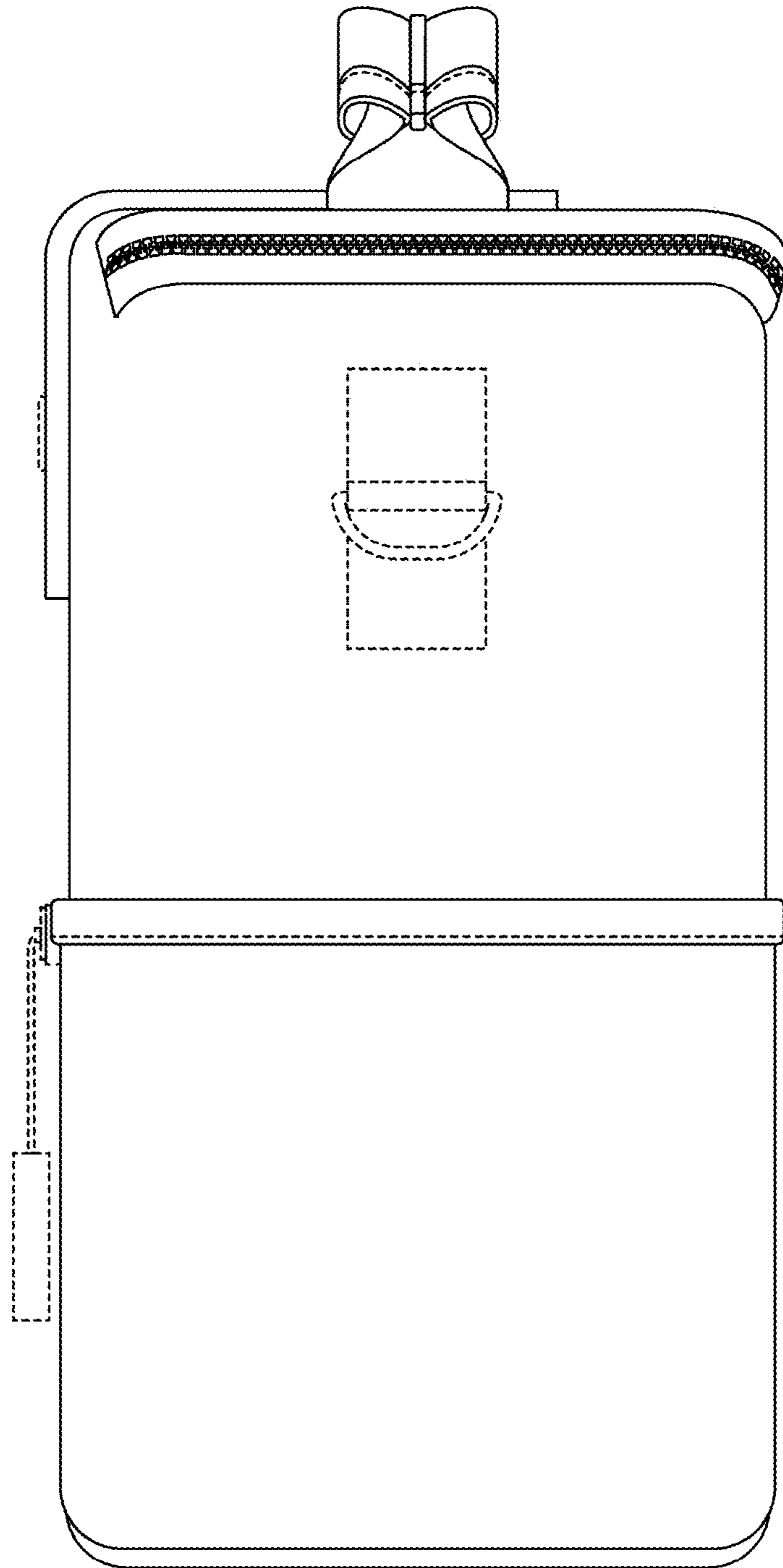

FIG. 5

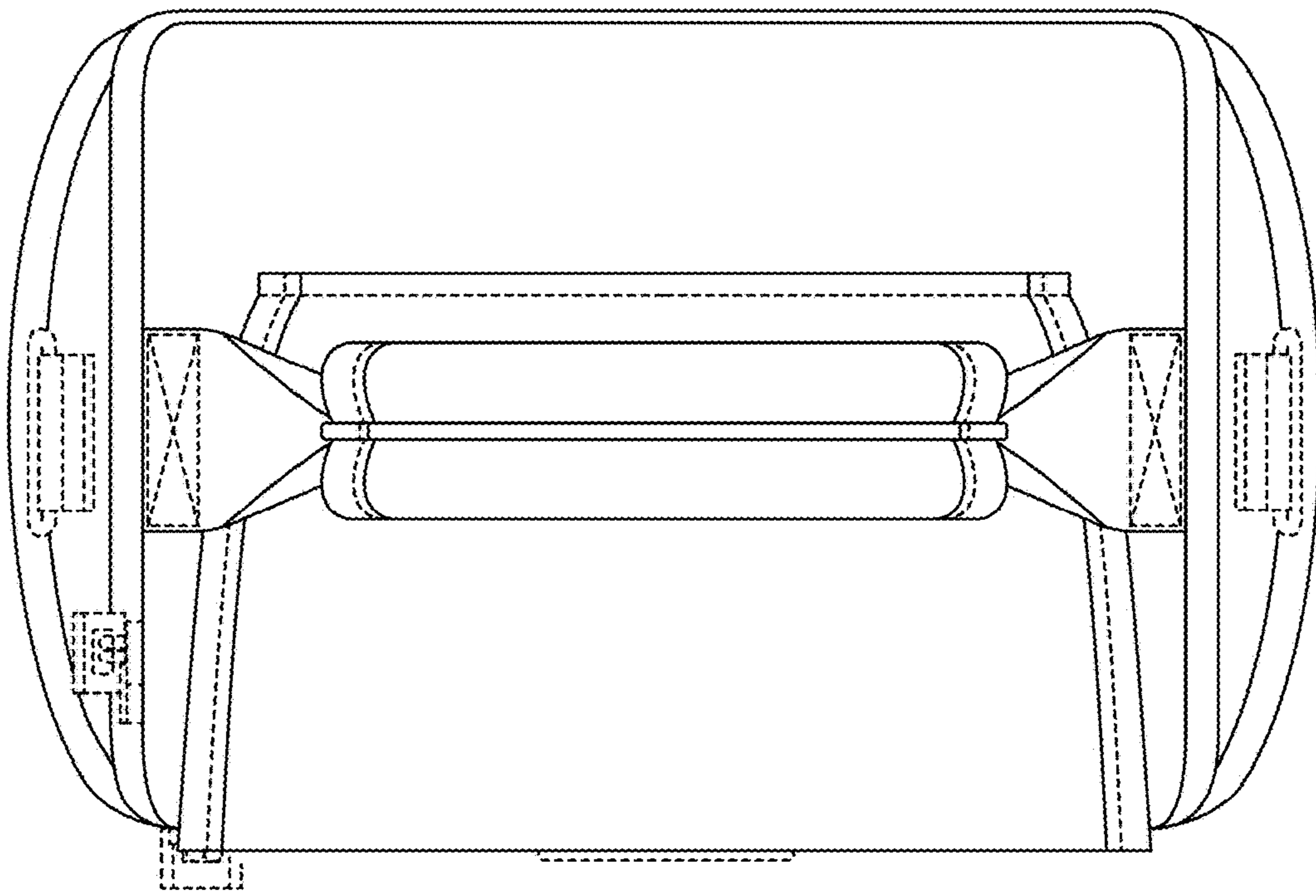

FIG. 6

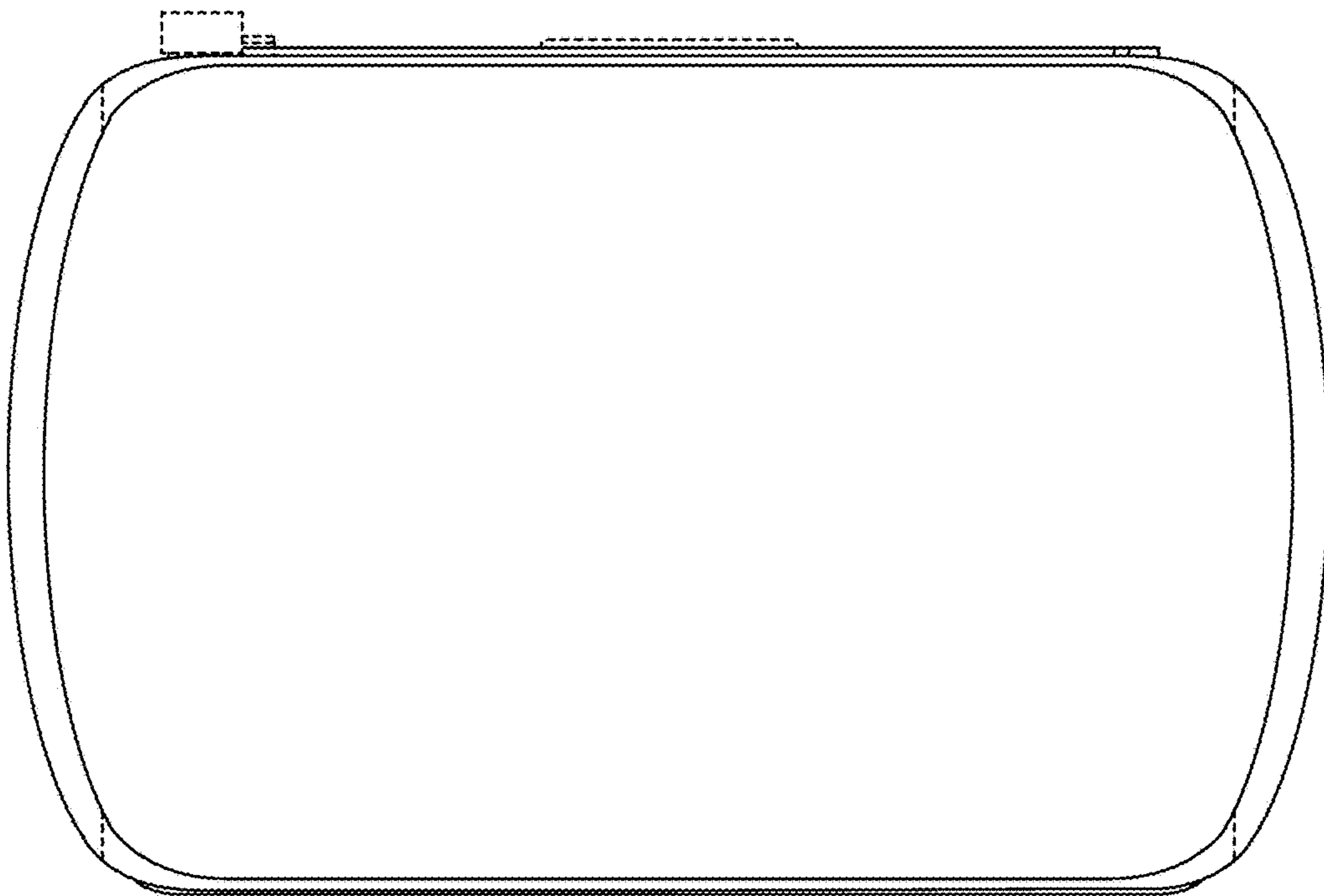

FIG. 7