



US00D981147S

(12) **United States Design Patent**
Walker

(10) **Patent No.:** **US D981,147 S**

(45) **Date of Patent:** **** *Mar. 21, 2023**

- (54) **HEALTH AND SAFETY UNIT**
- (71) Applicant: **First Reaction Ltd**, Portadown (GB)
- (72) Inventor: **Jason Walker**, Portadown (GB)
- (73) Assignee: **FIRST REACTION LTD**, Armagh (GB)

D304,656 S 11/1989 Hancock
 4,936,470 A * 6/1990 Prindle A47B 63/00
 211/104
 D309,734 S * 8/1990 Mackin D14/162
 4,960,307 A 10/1990 Nelsen
 D313,524 S 1/1991 Barnes
 (Continued)

- (*) Notice: This patent is subject to a terminal disclaimer.
- (**) Term: **15 Years**

FOREIGN PATENT DOCUMENTS

GB 2434746 A 8/2007
 JP 2011050527 A 3/2011

- (21) Appl. No.: **29/666,655**
- (22) Filed: **Oct. 15, 2018**
- (51) **LOC (14) Cl.** **06-04**
- (52) **U.S. Cl.**
USPC **D6/672**
- (58) **Field of Classification Search**
USPC D29/124, 125, 126, 129, 130; D3/201, D3/203.1; D6/672, 675, 675.1, 682, D6/682.2, 683.1, 512, 514, 524, 540, 545, D6/553, 569, 572, 567; D20/40, 42
CPC A62C 8/00; A62C 13/76; A62C 13/78; A47B 47/00; A47B 81/00; A47B 96/16; A47F 1/00; A47F 3/00; A47F 3/02; A47F 3/06; A47F 5/08; A47F 5/0807; A47F 5/0876; A47F 7/28; A61F 17/00
See application file for complete search history.

OTHER PUBLICATIONS

U.S. Appl. No. 29/666,622, filed Oct. 15, 2018, Walker.
 (Continued)

Primary Examiner — Kimberly Barnes
 (74) *Attorney, Agent, or Firm* — RMCK Law Group, PLC

(57) **CLAIM**

The ornamental design for a health and safety unit, as shown and described.

DESCRIPTION

FIG. 1 is a perspective view of a health and safety unit showing my new design;
 FIG. 2 is a front view of the health and safety unit of FIG. 1;
 FIG. 3 is a rear view of the health and safety unit of FIG. 1;
 FIG. 4 is a top view of the health and safety unit of FIG. 1;
 FIG. 5 is a bottom view of the health and safety unit of FIG. 1;
 FIG. 6 is a first side view of the health and safety unit of FIG. 1; and,
 FIG. 7 is a second side view of the health and safety unit of FIG. 1.
 The broken lines depict portions of the health and safety unit that form no part of the claimed design.

- (56) **References Cited**
- U.S. PATENT DOCUMENTS**
- D223,617 S * 5/1972 Smith D6/569
3,684,102 A * 8/1972 Colter A47B 81/00
211/88.01
- D247,660 S 4/1978 Tortorici
- 4,109,980 A * 8/1978 Brockman A47F 1/08
211/59.2
- D297,693 S * 9/1988 Norstedt D6/553
- D300,795 S 4/1989 Kellogg

1 Claim, 5 Drawing Sheets

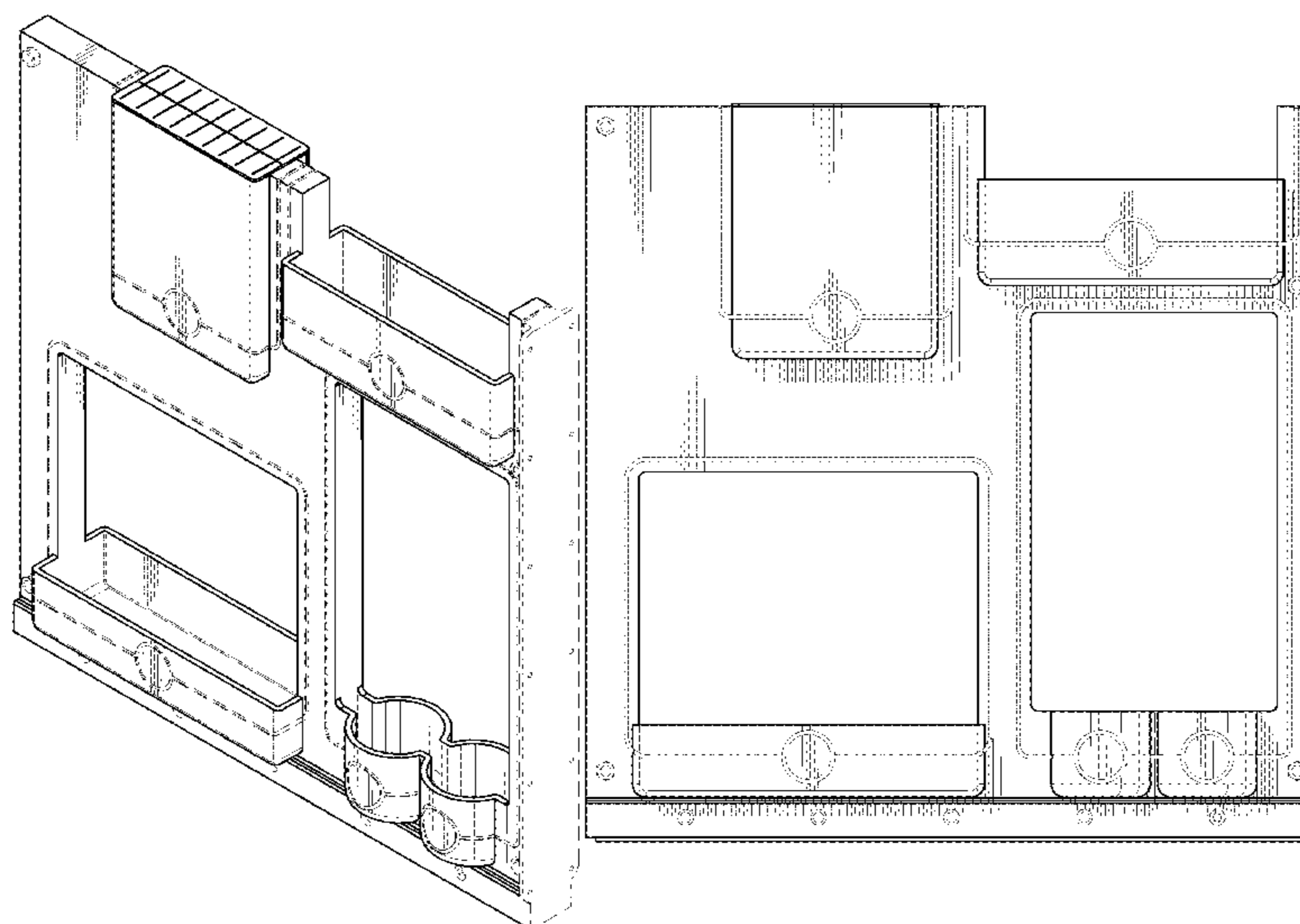

(56)

References Cited

U.S. PATENT DOCUMENTS

D337,016 S * 7/1993 Fortescue D19/77
 D354,646 S 1/1995 Weinstein
 5,526,943 A 6/1996 Thompson
 D385,136 S 10/1997 Gutke
 D385,287 S 10/1997 Westcott
 D386,639 S * 11/1997 Everett D6/525
 D391,296 S 2/1998 Hill
 D394,456 S 5/1998 Jack
 D416,385 S * 11/1999 Salazar D3/215
 D425,353 S 5/2000 Foy
 D452,944 S 1/2002 Schmidt
 D454,017 S * 3/2002 Kauzlarich D6/545
 6,571,967 B2 * 6/2003 Belokin A47F 5/08
 211/71.01
 7,188,738 B2 3/2007 Stafford et al.
 D542,582 S 5/2007 Stafford et al.
 D550,493 S * 9/2007 Coran D6/570
 D551,008 S 9/2007 Hidalgo
 D566,919 S 4/2008 Snell
 7,438,194 B2 10/2008 Wang
 7,543,701 B2 * 6/2009 Suda A45C 7/009
 206/231
 D606,347 S * 12/2009 Berry D6/553
 D620,294 S * 7/2010 Ma D6/567
 D639,092 S 6/2011 Lundy
 D700,454 S * 3/2014 Callif D6/567
 8,779,906 B2 * 7/2014 Manning G08B 15/00
 340/321

D762,404 S 8/2016 Williams
 D778,643 S 2/2017 Williams
 D808,188 S 1/2018 Cockburn et al.
 9,901,497 B2 2/2018 Colvin et al.
 D838,521 S 1/2019 Goldmeier
 D840,715 S 2/2019 Löenhielm
 D845,028 S 4/2019 Corona
 D845,029 S * 4/2019 Belokin D6/569
 10,542,849 B2 * 1/2020 Cockburn A47K 3/281
 D885,801 S * 6/2020 Walker D6/672
 D890,553 S * 7/2020 Walker D6/672
 10,907,892 B2 * 2/2021 Ciniello F25D 23/028
 D925,255 S * 7/2021 Walker D6/672
 11,278,752 B2 * 3/2022 Walker A47B 88/42
 2003/0209505 A1 * 11/2003 Belokin A47F 5/08
 211/75
 2008/0272078 A1 * 11/2008 Belokin A47F 5/08
 211/126.1
 2009/0108718 A1 4/2009 Craig et al.
 2010/0096350 A1 * 4/2010 Ma A47F 7/0028
 211/133.6
 2019/0126080 A1 * 5/2019 Walker A62C 3/006

OTHER PUBLICATIONS

U.S. Appl. No. 29/666,634, filed Oct. 15, 2018, Walker.
 U.S. Appl. No. 29/666,646, filed Oct. 15, 2018, Walker.
 U.S. Appl. No. 29/666,661, filed Oct. 15, 2018, Walker.

* cited by examiner

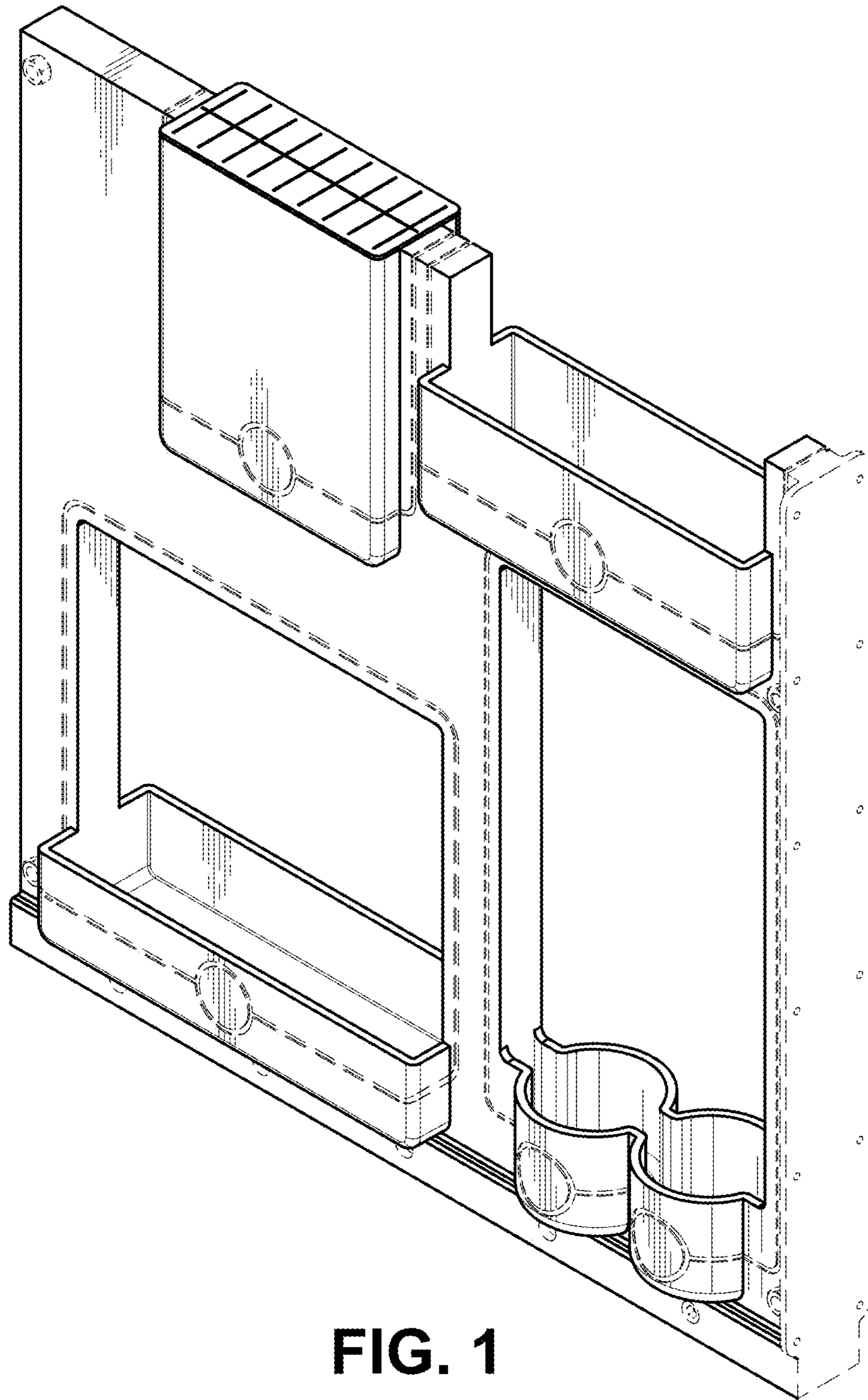

FIG. 1

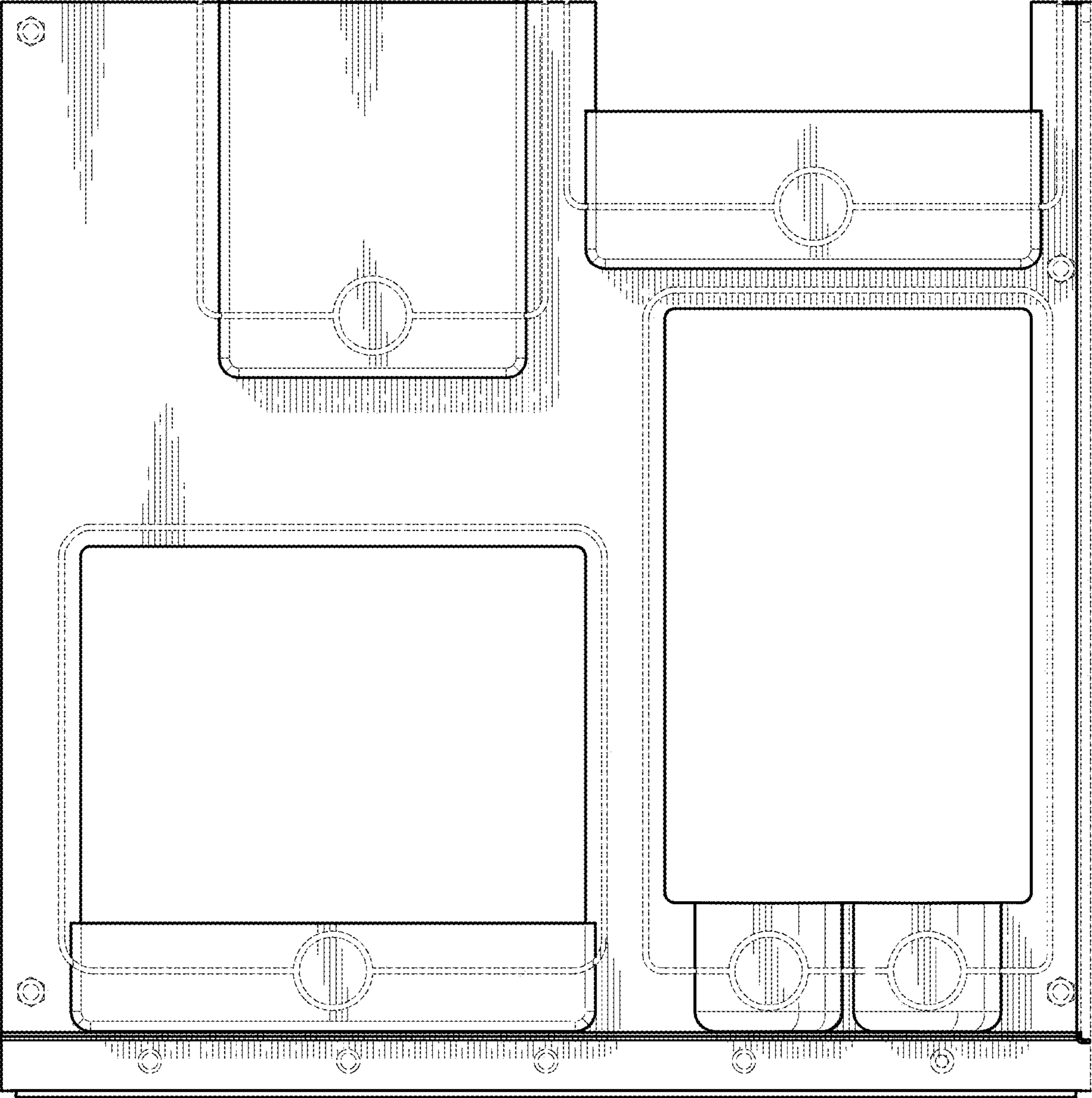

FIG. 2

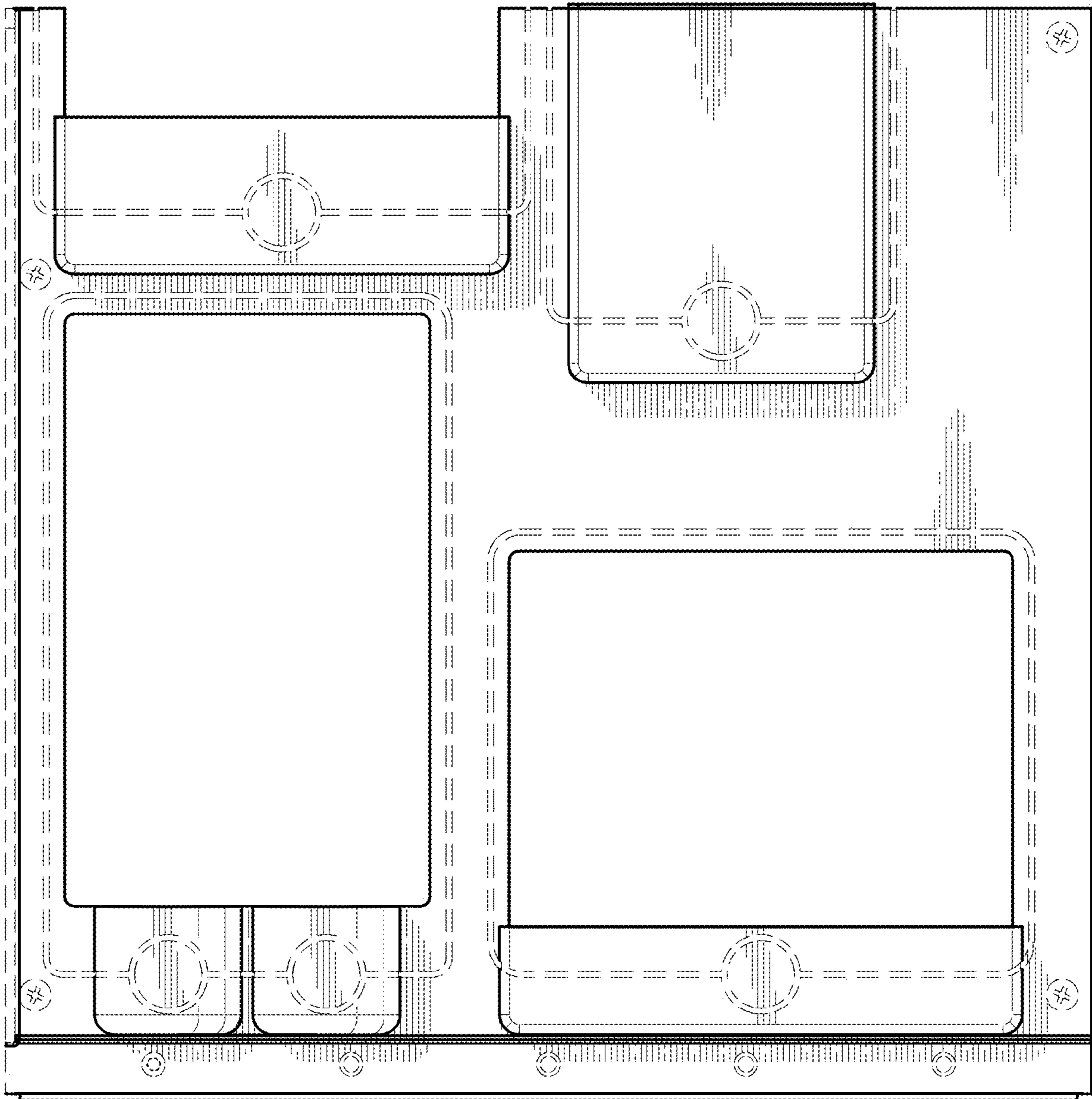

FIG. 3

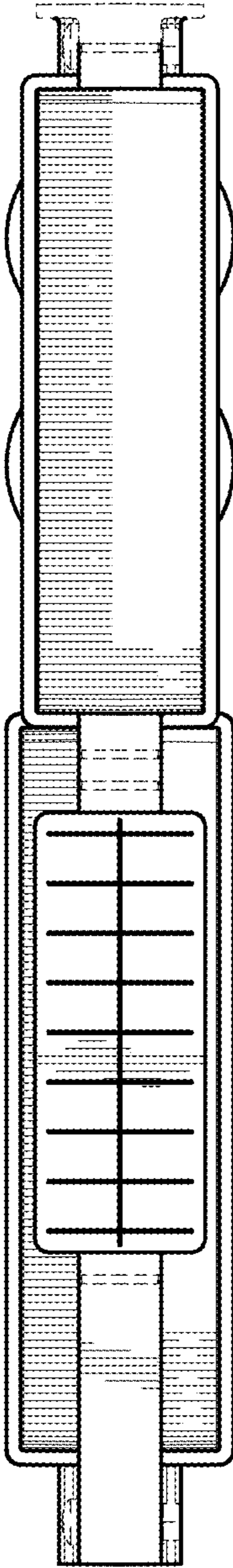

FIG. 4

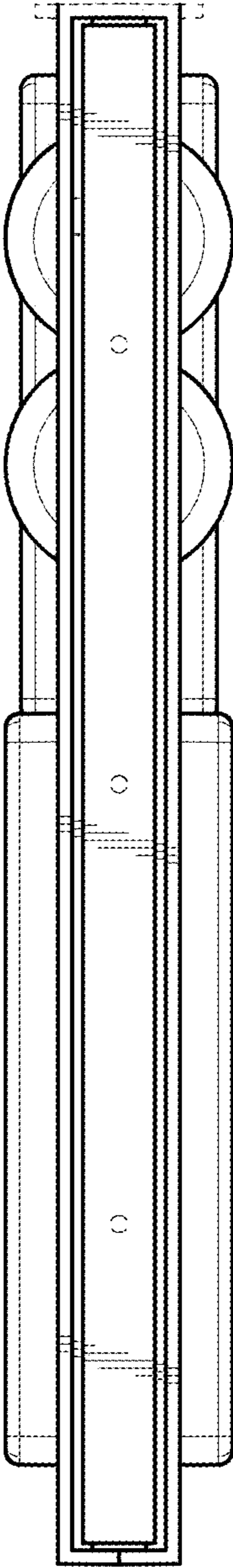

FIG. 5

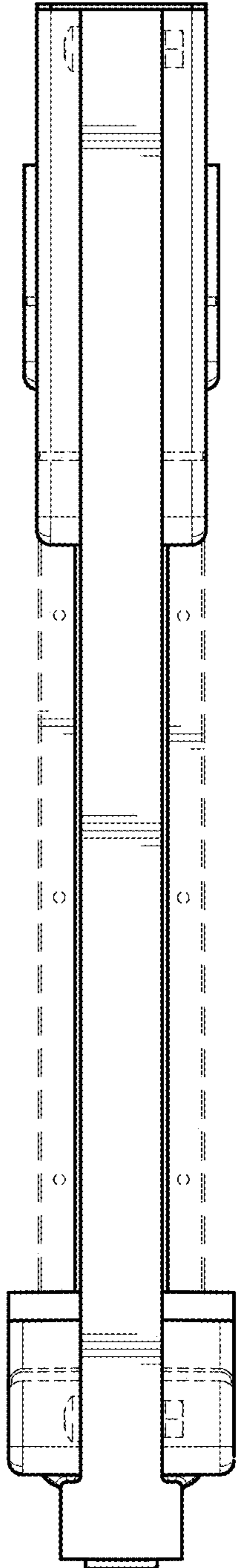

FIG. 6

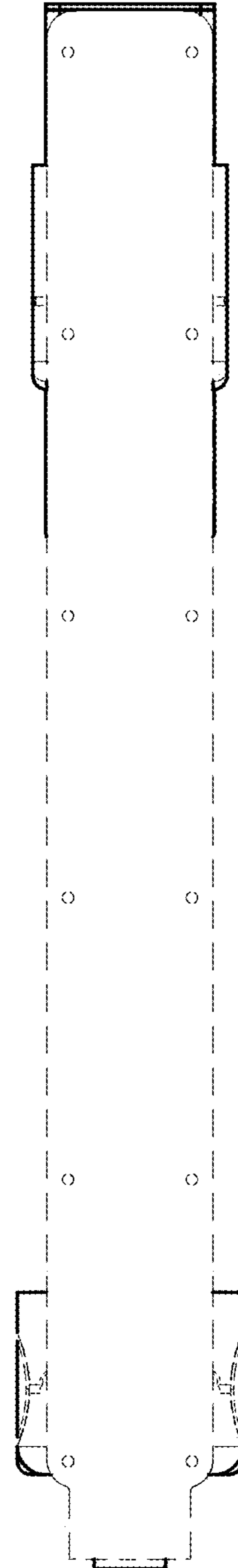

FIG. 7