



US00D981137S

(12) **United States Design Patent** (10) **Patent No.:** **US D981,137 S**
Wang (45) **Date of Patent:** **** Mar. 21, 2023**

(54) **TOILET BRUSH HOLDER**

(71) Applicant: **Qiyu Wang**, Taizhou (CN)

(72) Inventor: **Qiyu Wang**, Taizhou (CN)

(**) Term: **15 Years**

(21) Appl. No.: **29/842,794**

(22) Filed: **Jun. 16, 2022**

(51) **LOC (14) Cl.** **06-13**

(52) **U.S. Cl.**
USPC **D6/551**

(58) **Field of Classification Search**

USPC D6/524, 525, 551, 567, 574; D8/373;
D14/224, 447; D21/333

CPC ... A46B 2200/304; A47B 96/02; A47B 96/06;
A47K 17/00; A47K 11/10

See application file for complete search history.

(56) **References Cited**

U.S. PATENT DOCUMENTS

4,033,650 A * 7/1977 Alissandratos A46B 9/02
D6/524
D343,321 S * 1/1994 Emery D6/524
D467,457 S * 12/2002 Lin D6/551
D500,618 S * 1/2005 Nagoya D6/551
D832,858 S * 11/2018 Wengreen D14/447
D842,004 S 3/2019 Joseph
D845,666 S 4/2019 Li
D923,356 S * 6/2021 Wang D4/116
D935,219 S 11/2021 Wang
2020/0187731 A1 * 6/2020 Luo A47K 17/00

OTHER PUBLICATIONS

Design 6213888, App. date Jun. 16, 2022, Country code GB,
Publication date Jun. 16, 2022, Owner name Qiyu Wang (Year:
2022).*

Toilet Brush with Holder Creative Silicone, available in amazon.com, first available Dec. 24, 2020, site visited on Sep. 14, 2022, URL:https://www.amazon.com/Creative-Silicone-Cleaning-Household-Bathroom/dp/B08R6ZCT28?th=1 (Year: 2020).*

Toilet brush with wall mount, available in amazon.co.uk, first available Oct. 31, 2020, site visited on Sep. 14, 2022, URL:https://www.amazon.co.uk/dp/B08H4WYB89?&tag=renganath029-21 (Year: 2020).*

YEDYLY No Dead Corner Cactus Toilet Brush, available in walmart.com, site visited on Sep. 14, 2022, URL:https://www.walmart.com/ip/YEDYLY-No-Dead-Corner-Cactus-Toilet-Brush-New-Wall-Hanging-Silicone-With-Holder-Set/1047784226 (Year: 2022).*

* cited by examiner

Primary Examiner — Mary Ann Calabrese

Assistant Examiner — Mark David Wolfley

(74) *Attorney, Agent, or Firm* — Rumit Ranjit Kanakia

(57) **CLAIM**

The ornamental design for a toilet brush holder, as shown and described.

DESCRIPTION

FIG. 1 is a rear, top, left perspective view of a toilet brush holder showing my new design;

FIG. 2 is a front, bottom, left perspective view thereof;

FIG. 3 is a front view thereof;

FIG. 4 is a back view thereof;

FIG. 5 is a left side view thereof;

FIG. 6 is a right side view thereof;

FIG. 7 is a top view thereof; and,

FIG. 8 is a bottom view thereof.

The broken lines shown in the drawings depict portions of the toilet brush holder that form no part of the claimed design.

1 Claim, 8 Drawing Sheets

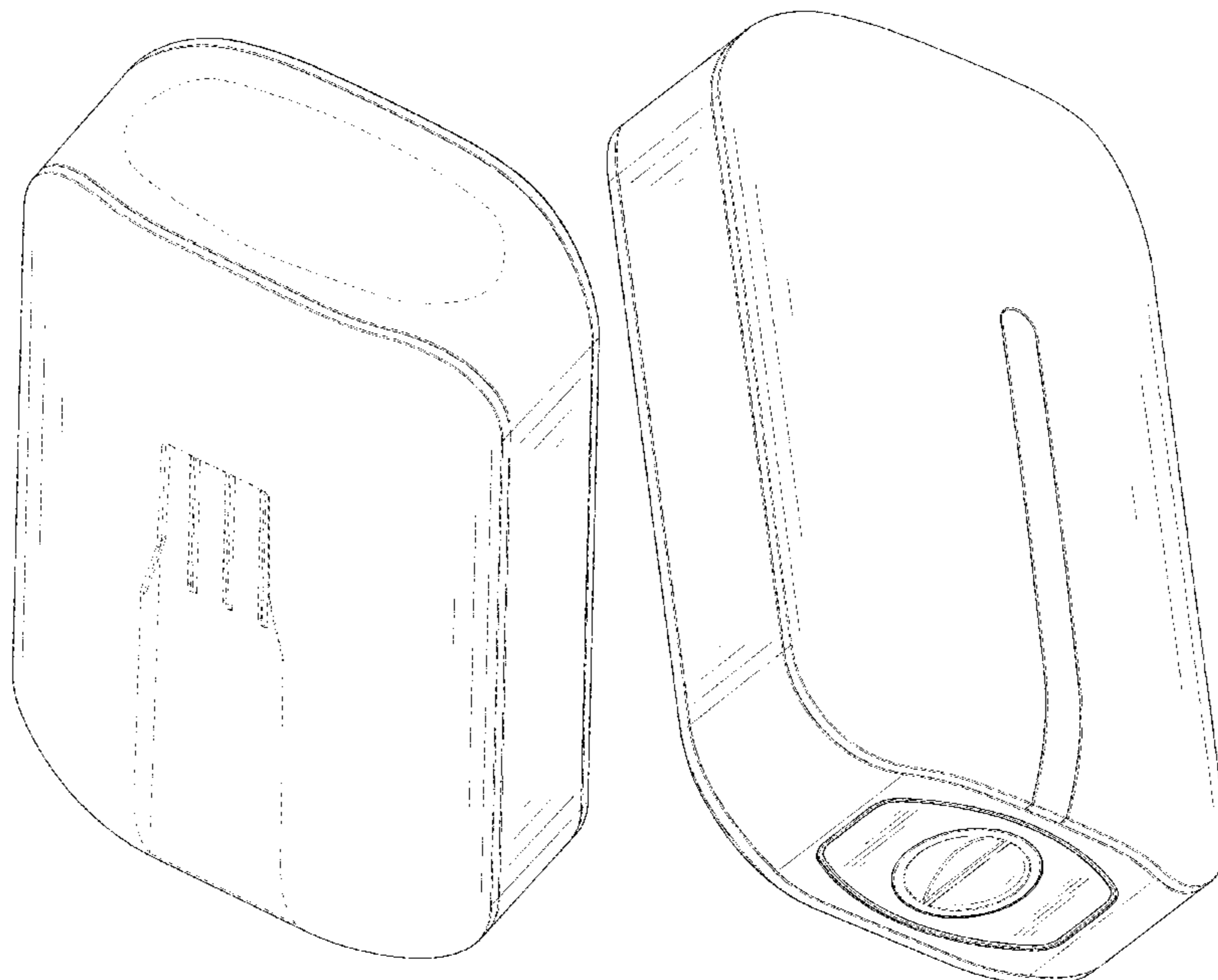

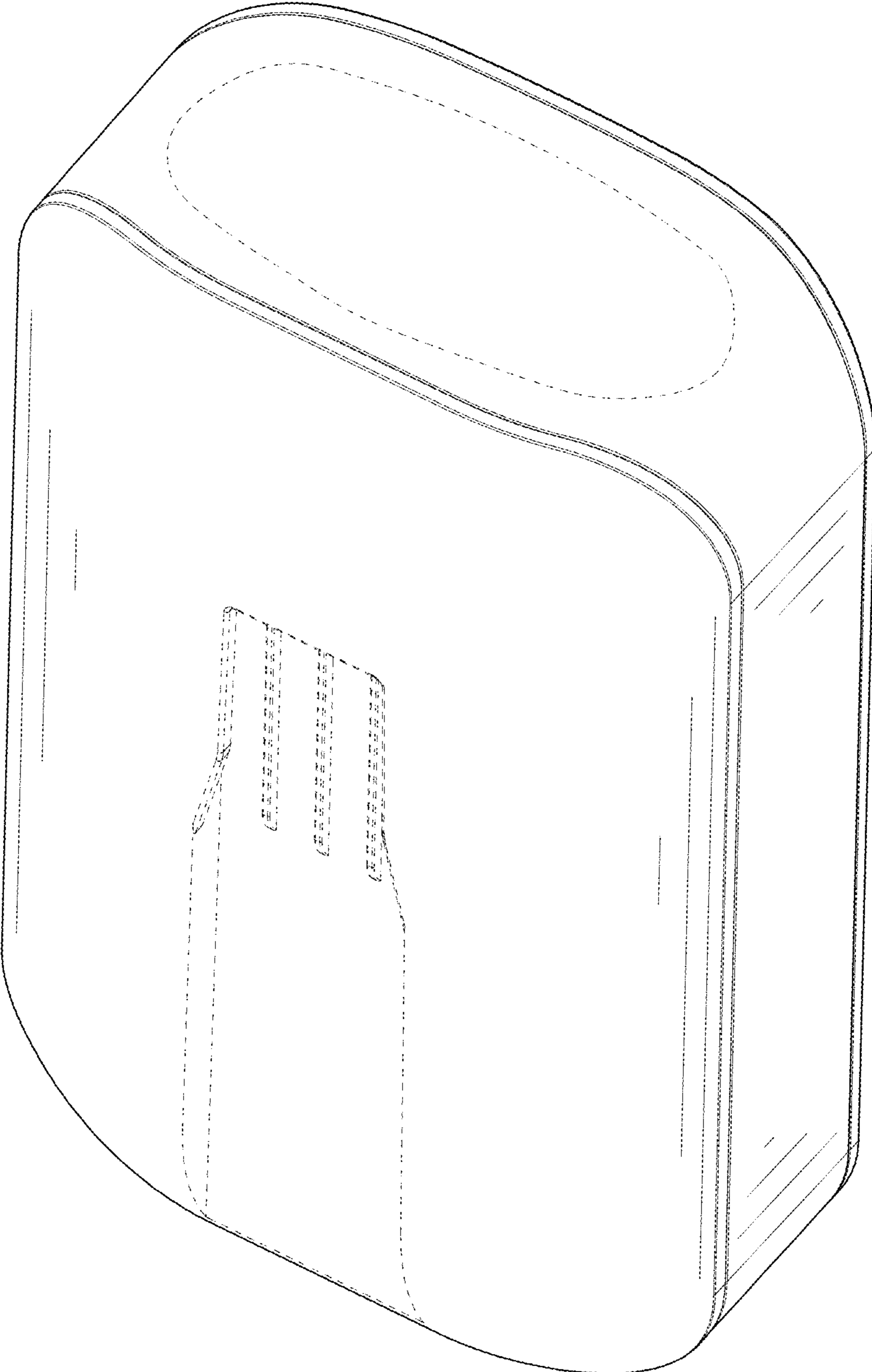

FIG. 1

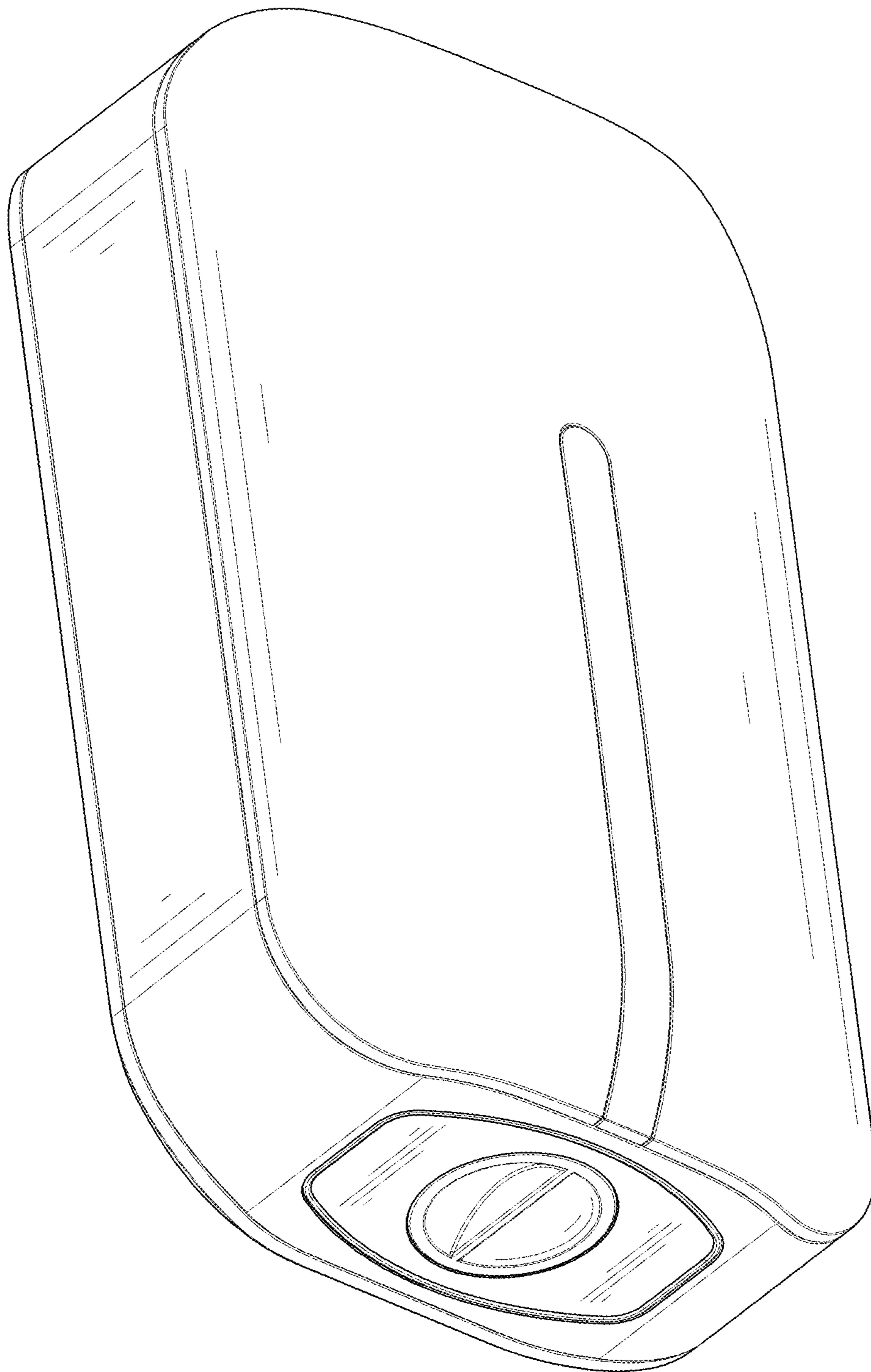

FIG. 2

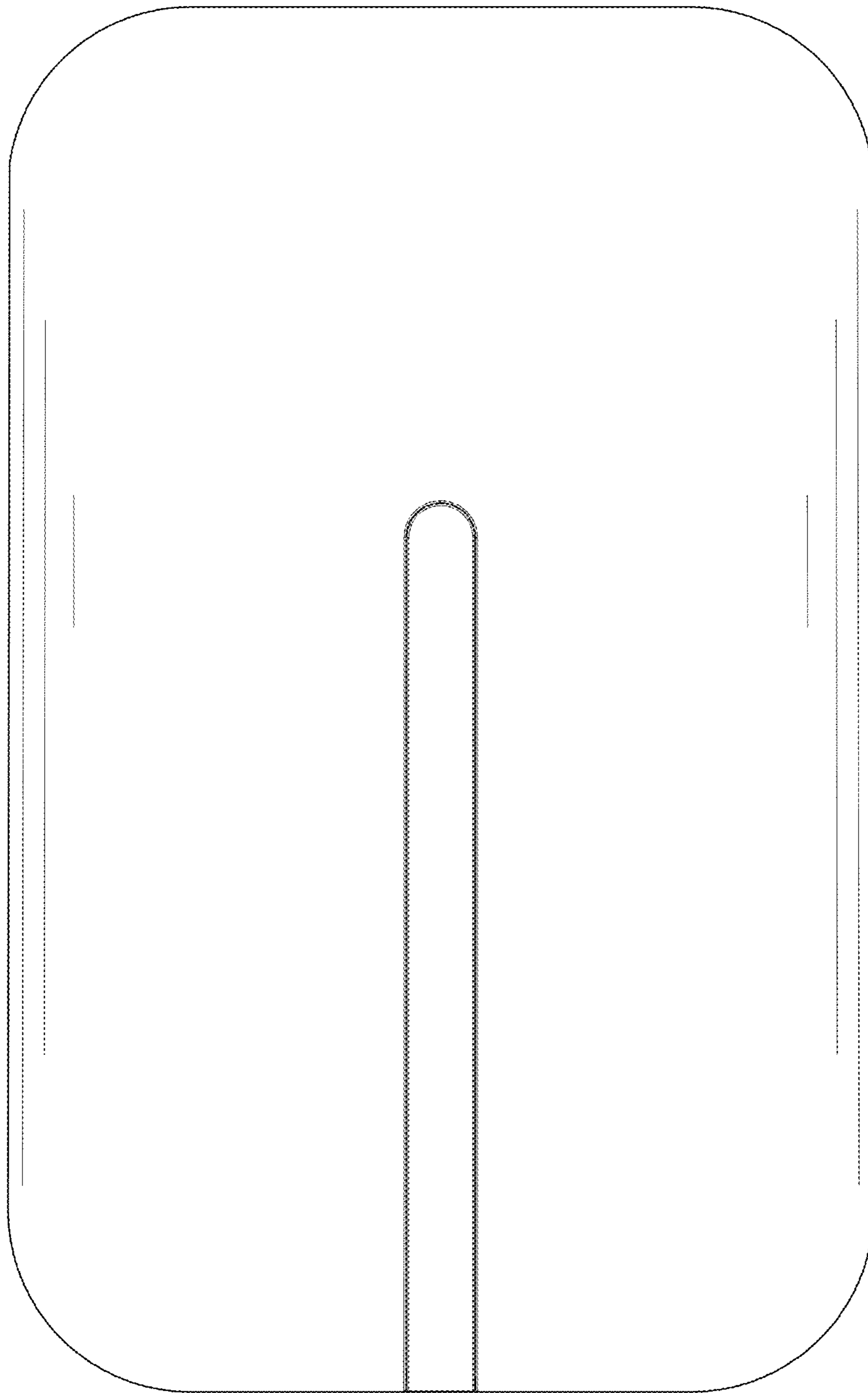

FIG. 3

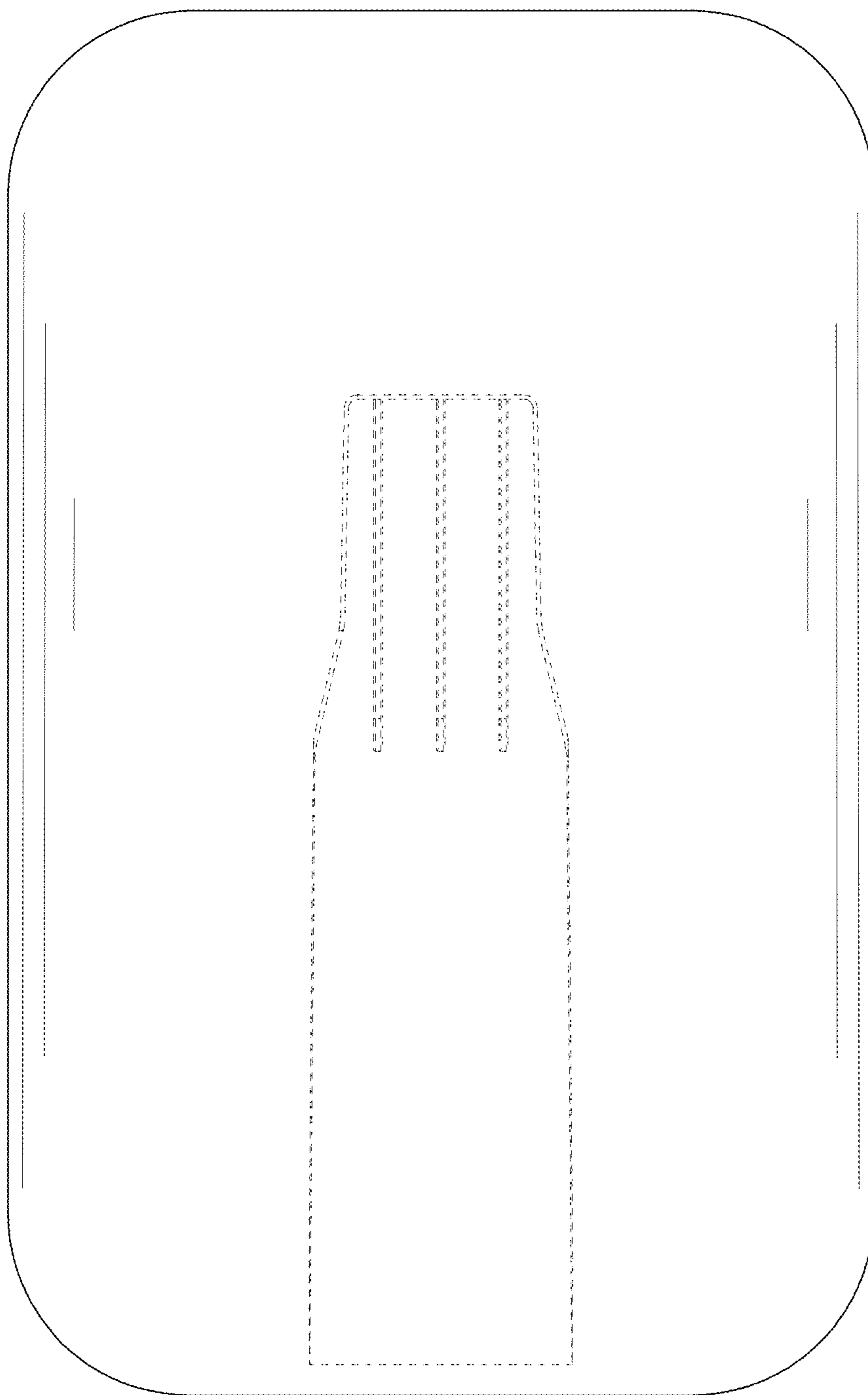

FIG. 4

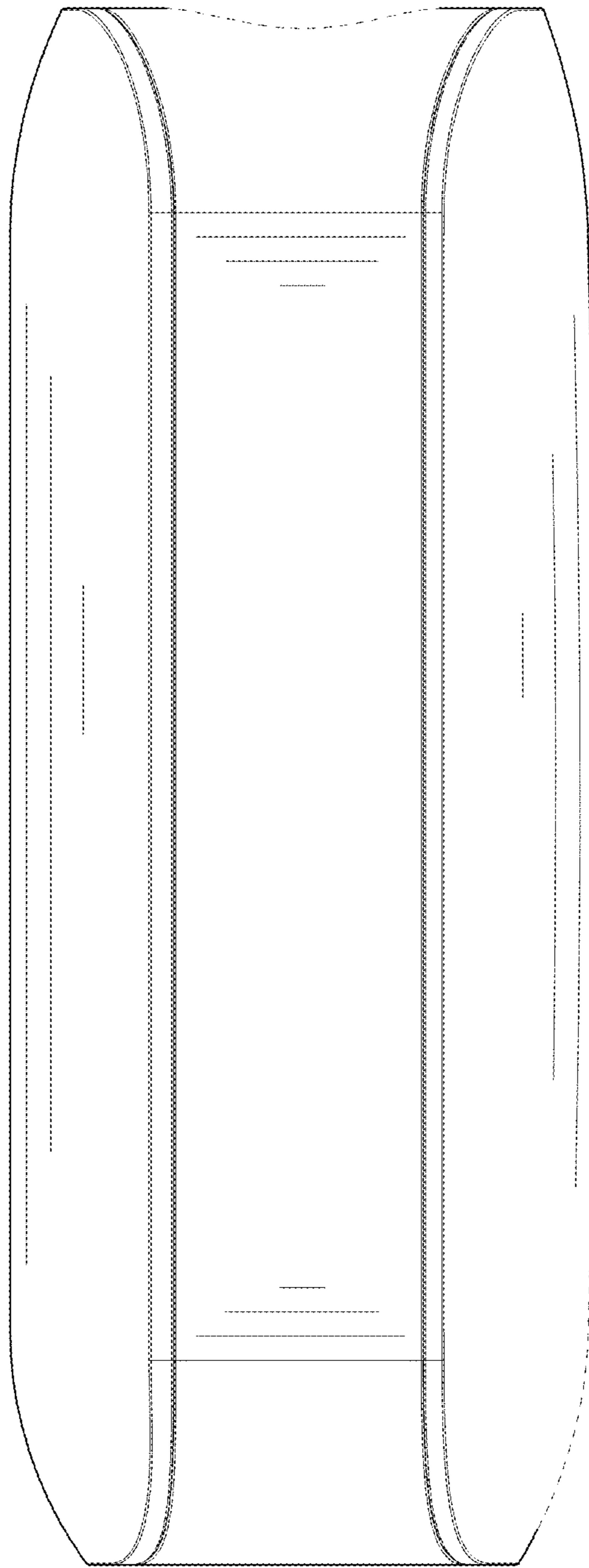

FIG. 5

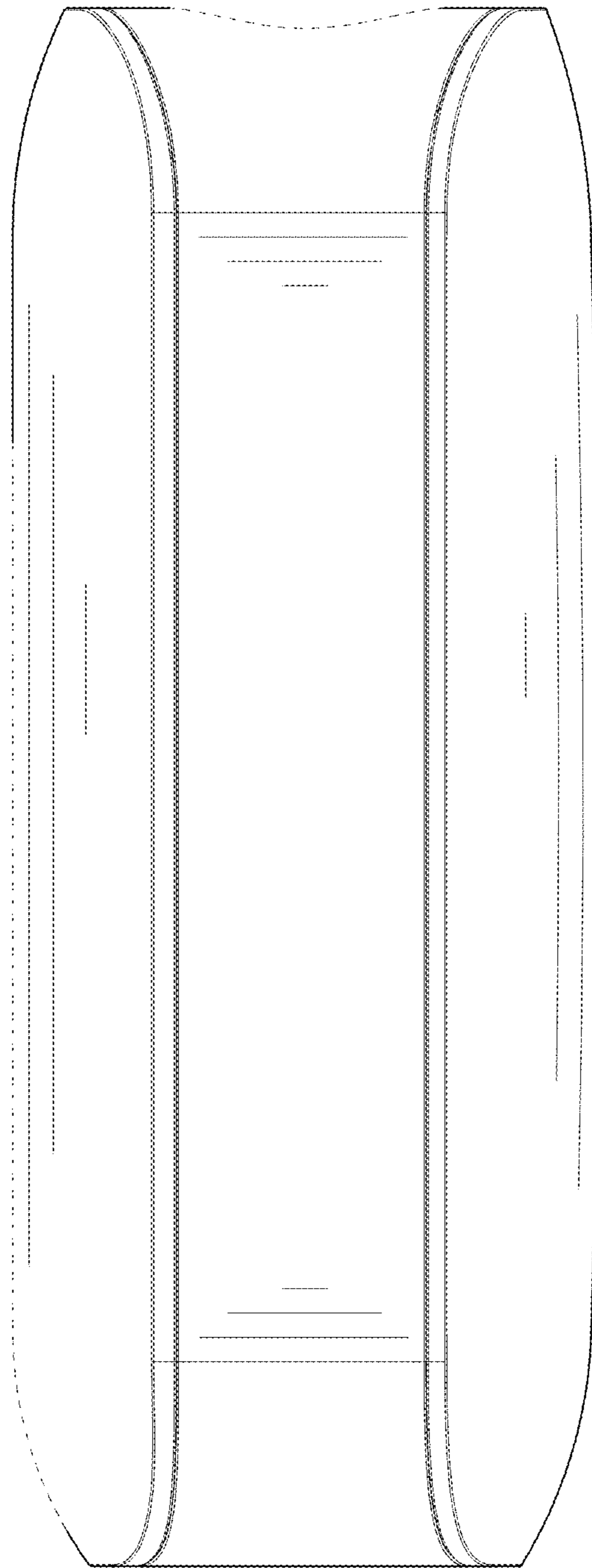

FIG. 6

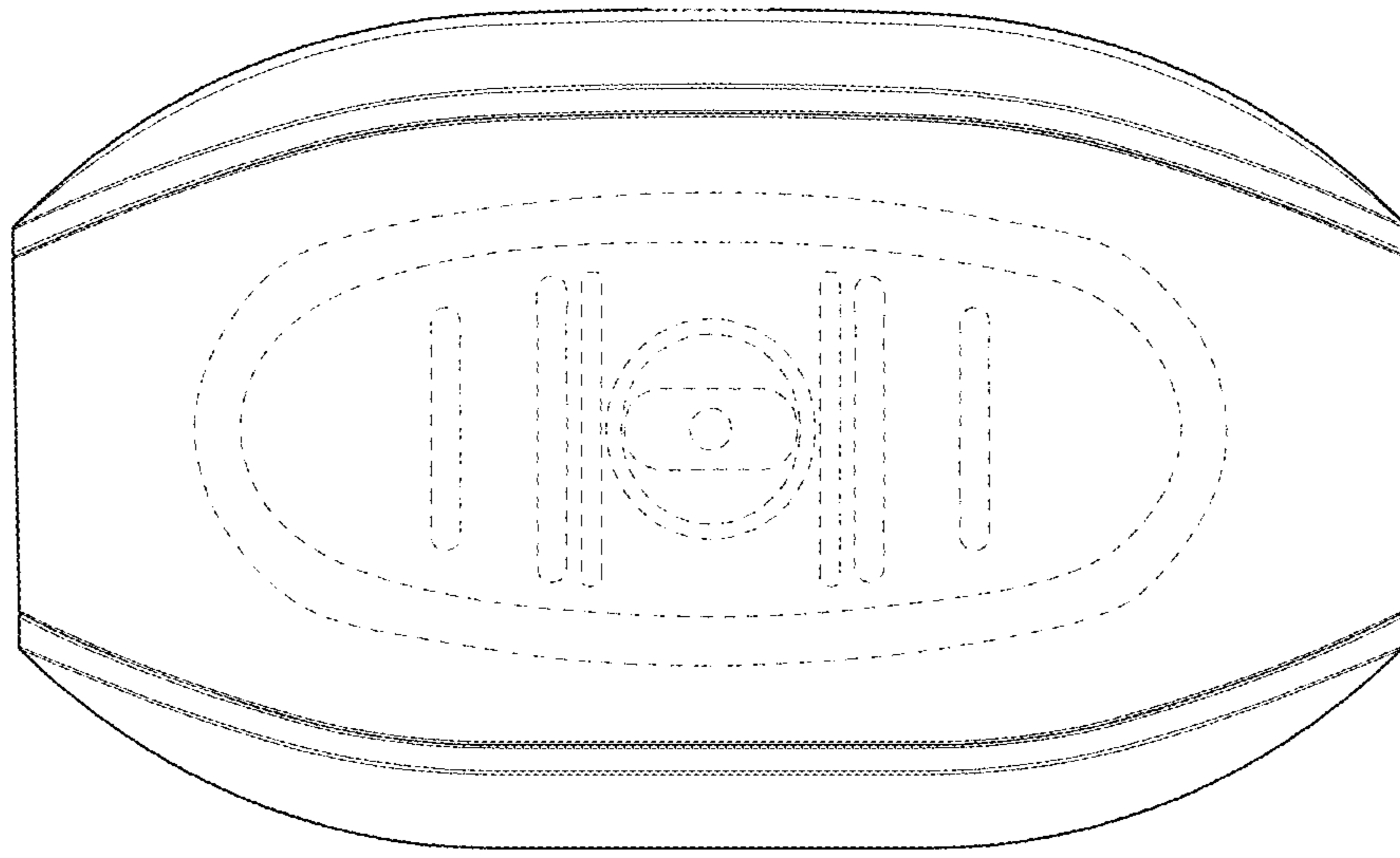

FIG. 7

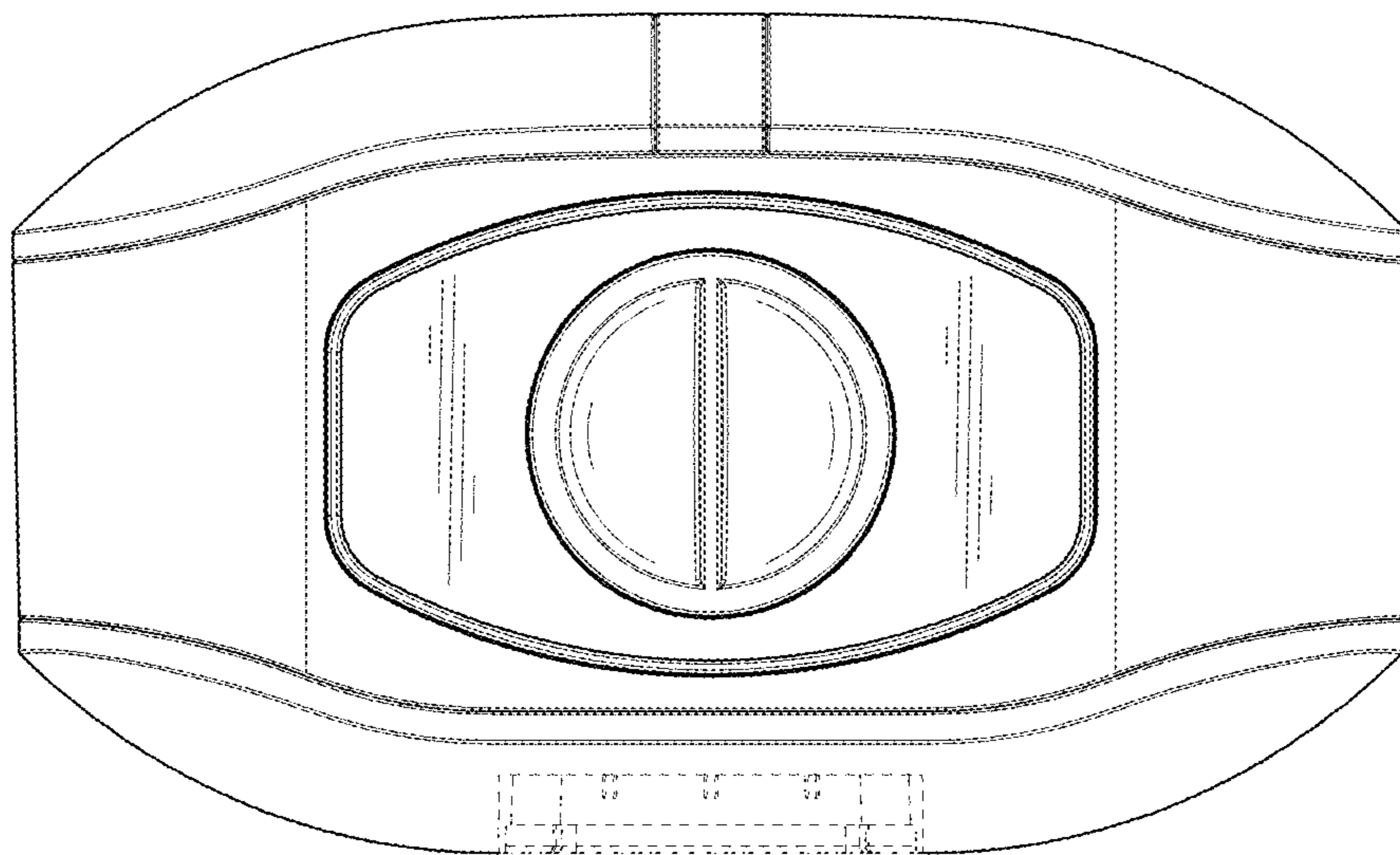

FIG. 8